

fluimac[®]
pump solution



COMPASS

MAG DRIVE PUMPS

Made in
Italy

www.fluimac.com

ENGLISH 

fluimac
pump solution



MAIN FEATURES

Fluimac is an original, young and dynamic company built in 2012 for a new concept of product. It is specialized in providing pump solutions with an innovative and continuously developing design of range. The huge experience, knowledge and efficiency of its team is the starting point of its own business. Fluimac stands out for its reliable and prompt technical support and assistance. The internal research and development department ensures the proficiency of its team, which constantly grows in order to satisfy all the customers' needs. The company keeps up with the constant evolution of the national and international market and its quality control guarantees innovative and certificated products, which respect current legal standards. The organization of the warehouse and the assembly/testing department, allows the company to offer short delivery times, immediate check of availability, speedy shipments and fast service assistance. The policy of Fluimac relies also on excellent customer service and a network of efficient, reliable distributors who ensure willingness, quality and technical support. This makes Fluimac a high quality company, grounded in excellence.

FLUIMAC'S CERTIFICATES



CE CONFORMITY
MARKING



ATEX



ISO 9001
BUREAU VERITAS
Certification

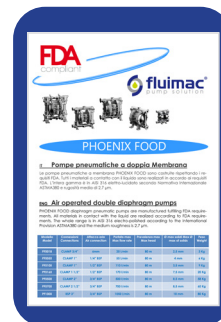

FDA COMPLIANT



EAC CONFORMITY
MARKING

MINI COMPASS

Fluimac MINI COMPASS are single stage, centrifugal impeller and magnetic drive pumps.

The range includes five models to deliver flows from 11 lt/min to 50 lt/min.

Compact dimension, low noise, absence of seals device make thee pumps ideal for application in any place or plant and can be incorporated into sophisticate equipment or “clean” environment.

The Drive magnet, outside the casing and keyed on the spindle, drives the magnetic impeller inside the hermetic casing. In this way, the traditional shaft seal and the consequent leakage problems are eliminated. So, there is no corrosion of the outer parts (motor and bearings) in the environment.

MAIN FEATURES

- Casing and impeller in PP and PVDF
- O-ring in EPDM and VITON
- Shaft/Bearing in ALLUMINA 99,7%+PTFEC
- Max Flow-Rate: 50 lt/min
- Max Delivery Head: 8mt
- Temperature from -5°C to +90°C
- Max Viscosity: 20cps
- Electric Motors from 6W to 65W
- Max S.G.: 1,1

INSTALLATION



POSITIVE SUCTION

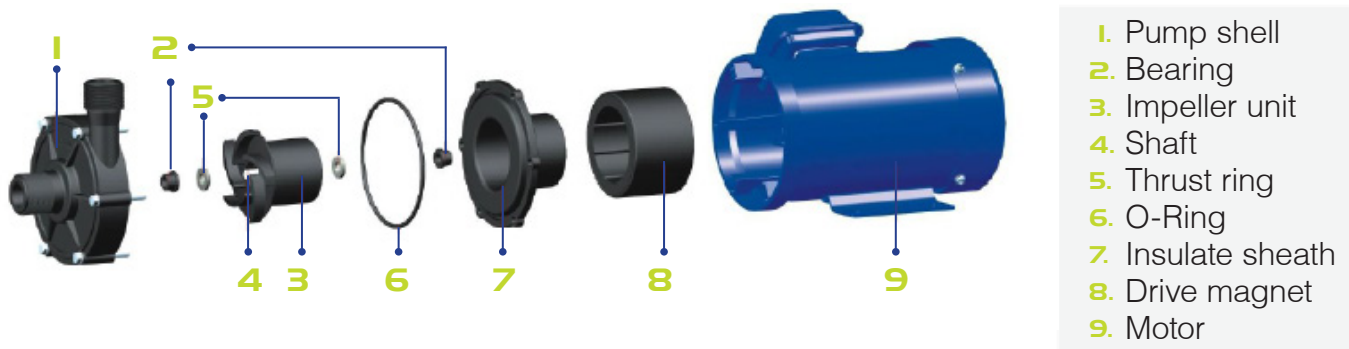

1. Pump shell
2. Bearing
3. Impeller unit
4. Shaft
5. Thrust ring
6. O-Ring
7. Insulate sheath
8. Drive magnet
9. Motor

MOTORS

MODEL	POWER	VOLTAGE	FREQUENCY	PROTECTION
MC 10	6W	220/240V	50/60Hz	IP54
MC 20	20W	220/240V	50/60Hz	IP54
MC 30	45W	220/240V	50/60Hz	IP54
MC 30H	45W	220/240V	50/60Hz	IP54
MC 40	65W	220/240V	50/60Hz	IP54

MINI COMPASS



MC 10



MC 20



MC 30



MC 30H



MC 40

PERFORMANCE

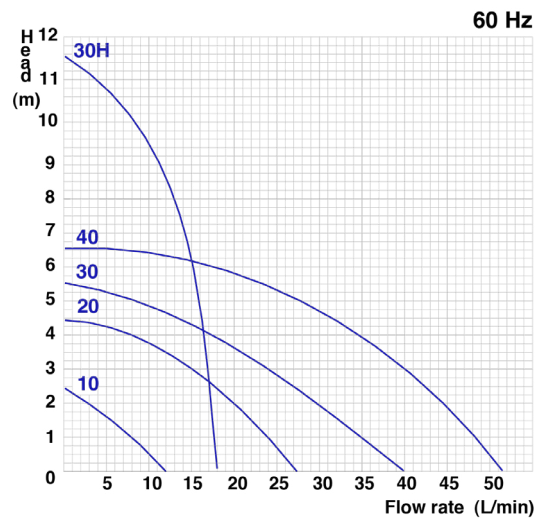
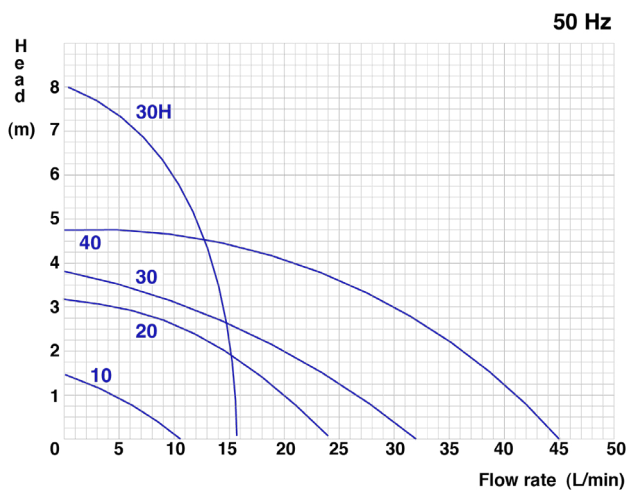

DIMENSIONS

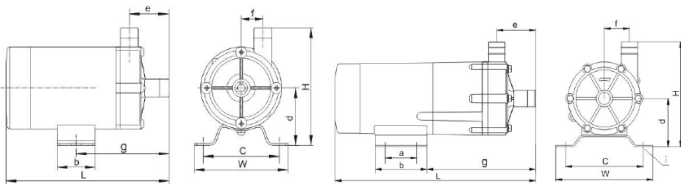

MODEL	W	H	L	a	b	c	d	e	F	g	i	INLET/OUTLET	WEIGHT
10	74	83	129	-	30	60	36	31	17	74	2-Ø6	14mm	0,9 Kg
20	85	115	211	30	50	68	56	38.5	28.5	106	5,5 x 10	3/4"	1,9 Kg
30	120	130	248	40	64	100	60	48	31	131	4-Ø9	3/4"	3,1 Kg
30H	120	130	234	40	64	100	60	40	40	120	4-Ø9	3/4"	3,1 Kg
40	120	134	260	45	75	100	64	48	31	137	4-9 x 14	3/4"	3,8 Kg

COMPOSITION

MODEL	CASING	O RING	BUSHING + SHAFT	MOTOR	MOTOR POWER
MC 10					S06 = 6w
MC 20					S20 = 20w
MC 30	P = PP K = PVDF	D = EPDM V = VITON	TA = PTFEC + ALLUMINA 99,7%	1 P = 1PH	S45 = 45w
MC 30H					S45 = 45w
MC 40					S65 = 65w

The separation of liquid chamber/atmosphere by means of an isolation shell is the best solution to pump aggressive chemical, high purity liquids and liquids difficult to seal. Hermetic seal-less injection moulded thermoplastic pumps are the best solution for light duty applications.

Mag drive centrifugal pumps series COMPASS are made of Polypropylene and PVDF, and are suitable for high corrosive liquids. Thanks to the innovative mag drive system, COMPASS series reduce the risks of leakage and emissions and the maintenance costs.

The transmission of the motion occurs through magnetic joints without any mechanical seal and this design guarantees the maximum safety and efficiency.

The pumped liquid has to be clean and without solids in suspension.

MAIN FEATURES

- Casing and impeller in PP/PVDF
- O-ring in EPDM and VITON
- ALLUMINA + PTFEC 99,7% (standard)
- Max flow: 35 m³/h; Max head 25 mts
- Temperature: from -5 °C to +90°C
- Max viscosity: 200 CPS
- Max system pressure: 5 bar
- Electric motors from 0,12Kw up to 4kW

INSTALLATION



POSITIVE SUCTION

Few components (extremely easy maintenance), competitive prices, guaranteed chemical compatibility

The rear shell is made of thermoplastic materials, ellipsoidal profile, zero magnetic losses, GFR PP or CFR PVDF materials

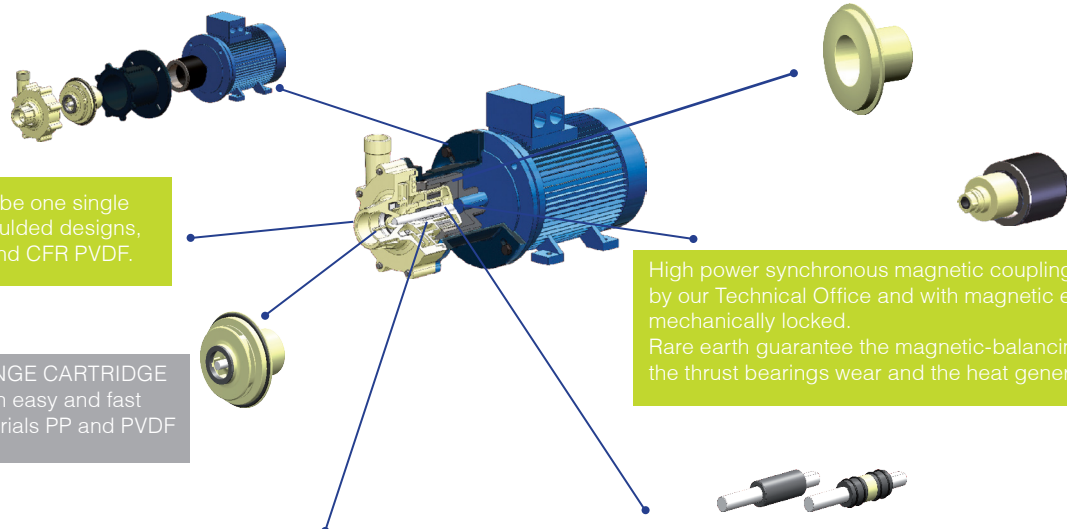

Pump casing shall be one single piece, injection moulded designs, made of GFR PP and CFR PVDF.

RWP QUICK CHANGE CARTRIDGE KIT to guarantee an easy and fast maintenance, materials PP and PVDF

The sealing system with O-Rings prevents from leaking in the atmosphere – different materials available:

- EPDM
- VITON®

High power synchronous magnetic coupling designed by our Technical Office and with magnetic elements mechanically locked.

Rare earth guarantee the magnetic-balancing to avoid the thrust bearings wear and the heat generation

Field assembling of the product lubricated bearing arrangement does not require special tools. The Shaft / Bearing materials are available in two different configurations to provide the best solution for each application:

- PTFEC – ALLUMINA 99,7% (standard)
- CARBON – ALLUMINA 99,7%

PP



PVDF



TECHNICAL DATA

Inlet connections	1" f
Outlet connections	1/2" m
Max. Flow rate	3,5 m3/h
Max. Delivery head	7,5 mts
Max Viscosity	100 CPS
Temperature PP	-5°C +65°C
Temperature PVDF	-10°C +90°C
Impeller	Semi-opened

PERFORMANCE

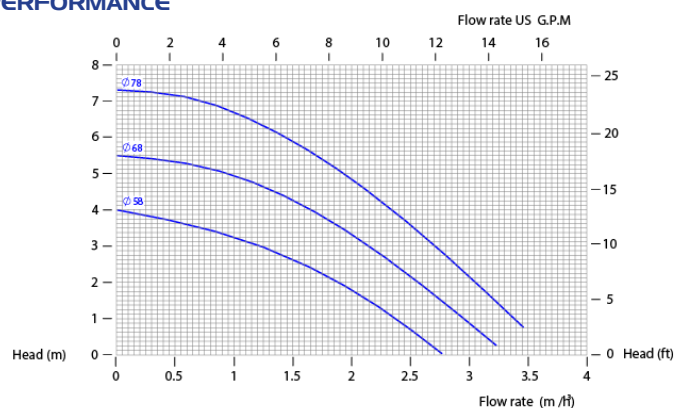

The curves and performance values refer to pumps with free delivery outlet with water at 20 °C, and two poles motor 50 Hz

SPECIFIC GRAVITY TABLE

IMPELLER	0,12 Kw
ø 78 mm	up to 1,1
ø 68 mm	up to 1,3
ø 58 mm	up to 1,5

MOTOR SPECIFICATION

SIZE	Kw	RPM
IEC 56	0,12	2 poles - 2900

DIMENSIONS

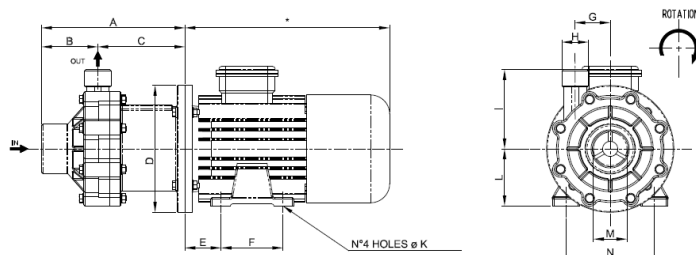

A	B	C	D	E	F	G	H	I	L	M	N	K
114	38,5	75,5	120	36	71	34	1/2"	80	56	1"	90	5,8

*Depend on the manufacturer

COMPOSITION

MODEL	CASING	O RING	BUSHING + SHAFT	IMPELLER	CONNECTIONS	MOTOR	MOTOR POWER
CM04	P = PP K = PVDF	D = EPDM V = VITON	TA = PTFEC + ALLUMINA 99,7%	78 = ø 78 mm STD 68 = ø 68 mm 58 = ø 58 mm	1 = BSP STD 2 = FLANGED	IE = 3PH STD X = ATEX 1P = 1PH - = NO MOTOR	0,12 = 0,12 Kw STD

PP



PVDF



TECHNICAL DATA

Inlet connections	1" f
Outlet connections	3/4" m
Max. Flow rate	7 m3/h
Max. Delivery head	8,5 mts
Max Viscosity	150 CPS
Temperature PP	-5°C +65°C
Temperature PVDF	-10°C +90°C
Impeller	closed

PERFORMANCE

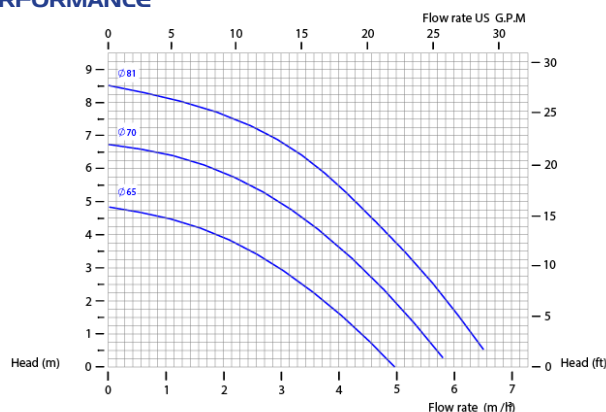

The curves and performance values refer to pumps with free delivery outlet with water at 20 °C, and two poles motor 50 Hz

SPECIFIC GRAVITY TABLE

IMPELLER	0,25 KW	0,37 KW
ø 81 mm	up to 1,1	up to 1,5
ø 70 mm	up to 1,3	up to 1,8
ø 65 mm	up to 1,6	up to 2

MOTOR SPECIFICATION

SIZE	Kw	RPM
IEC 63	0,25	2 poles - 2900
IEC 63	0,37	2 poles - 2900

DIMENSIONS

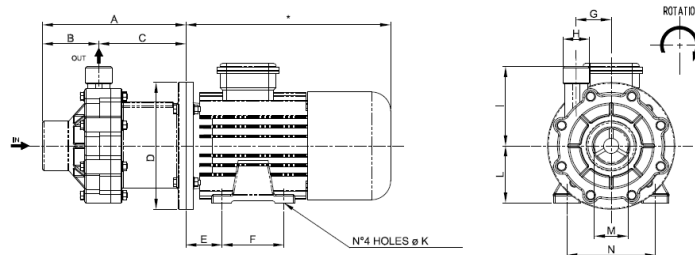

A	B	C	D	E	F	G	H	I	L	M	N	K
143	59	84	140	40	80	46	3/4"	91	63	1"	100	7

*Depend on the manufacturer

COMPOSITION

MODEL	CASING	O RING	BUSHING + SHAFT	IMPELLER	CONNECTIONS	MOTOR	MOTOR POWER
CM06	P = PP K = PVDF	D = EPDM V = VITON	TA = PTFEC + ALLUMINA 99,7%	81 = ø 81 mm STD 70 = ø 70 mm 65 = ø 65 mm	1 = BSP STD 2 = FLANGED	IE = 3PH STD X = ATEX 1P = 1PH - = NO MOTOR	0,25 = 0,25 Kw STD 0,37 = 0,37 Kw

PP



PVDF



TECHNICAL DATA

Inlet connections	1" 1/2 f
Outlet connections	1" m
Max. Flow rate	13 m3/h
Max. Delivery head	14 mts
Max Viscosity	200 CPS
Temperature PP	-5°C +65°C
Temperature PVDF	-10°C +90°C
Impeller	closed

PERFORMANCE

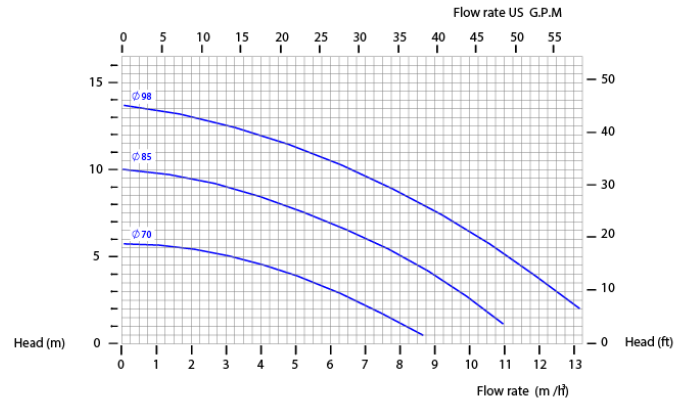

The curves and performance values refer to pumps with free delivery outlet with water at 20°C, and two poles motor 50 Hz

SPECIFIC GRAVITY TABLE

IMPELLER	0,55 KW	0,75 KW
ø 98 mm	up to 1,1	up to 1,3
ø 85 mm	up to 1,5	up to 1,8
ø 70 mm	up to 1,8	up to 2

MOTOR SPECIFICATION

SIZE	Kw	RPM
IEC 71	0,55	2 poles - 2900
IEC 71	0,75	2 poles - 2900

DIMENSIONS

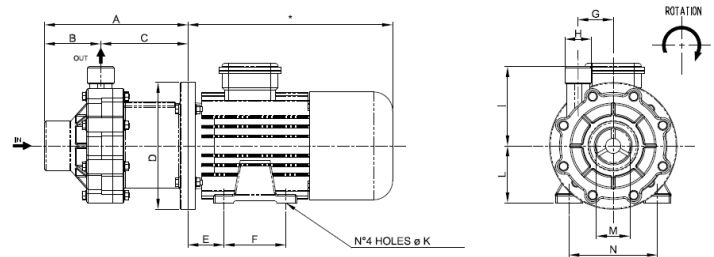

A	B	C	D	E	F	G	H	I	L	M	N	K
180	70,8	109,5	160	45	90	44	1"	100	71	1"1/2	112	7

*Depend on the manufacturer

COMPOSITION

MODEL	CASING	O RING	BUSHING + SHAFT	IMPELLER	CONNECTIONS	MOTOR	MOTOR POWER
CM10	P = PP K = PVDF	D = EPDM V = VITON	TA = PTFEC + ALLUMINA 99,7%	98 = ø 98 mm STD 85 = ø 85 mm 70 = ø 70 mm	1 = BSP STD 2 = FLANGED	IE = 3PH STD X = ATEX 1P = 1PH - = NO MOTOR	0,55 = 0,55 Kw STD 0,75 = 0,75 Kw

PP



PVDF



TECHNICAL DATA

Inlet connections	2" f
Outlet connections	1"1/4 m
Max. Flow rate	23,5 m3/h
Max. Delivery head	20 mts
Max Viscosity	200 CPS
Temperature PP	-5°C +65°C
Temperature PVDF	-10°C +90°C
Impeller	closed

PERFORMANCE

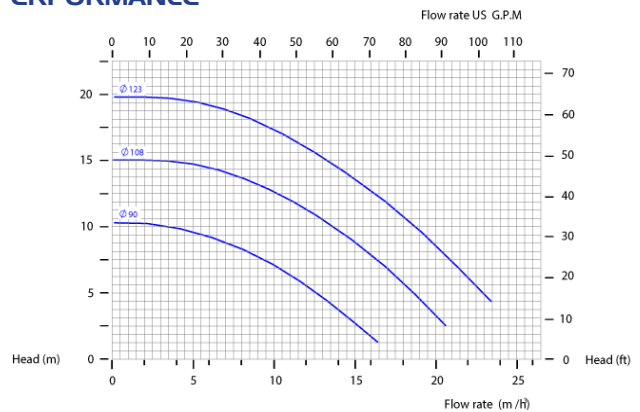

The curves and performance values refer to pumps with free delivery outlet with water at 20 °C, and two poles motor 50 Hz

SPECIFIC GRAVITY TABLE

IMPELLER	1,1 KW	1,5 KW
ø 123 mm	up to 1	up to 1,1
ø 108 mm	up to 1,2	up to 1,5
ø 90 mm	up to 1,5	up to 1,8

MOTOR SPECIFICATION

SIZE	Kw	RPM
IEC 80	1,1	2 poles - 2900
IEC 80	1,5	2 poles - 2900

DIMENSIONS

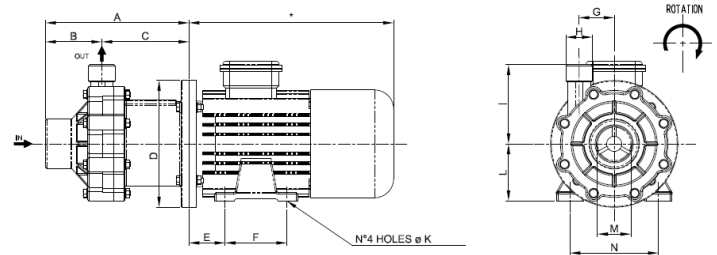

A	B	C	D	E	F	G	H	I	L	M	N	K
231	81	150	200	50	100	62,5	1"-1/4	125	80	2"	125	9,5

*Depend on the manufacturer

COMPOSITION

MODEL	CASING	O RING	BUSHING + SHAFT	IMPELLER	CONNECTIONS	MOTOR	MOTOR POWER
CM15	P = PP K = PVDF	D = EPDM V = VITON	TA = PTFEC + ALLUMINA 99,7%	123 = ø 123 mm STD 108 = ø 108 mm 90 = ø 90 mm	1 = BSP STD 2 = FLANGED	IE = 3PH STD X = ATEX - = NO MOTOR	1,1 = 1,1 Kw STD 1,5 = 1,5 Kw

PP



PVDF



TECHNICAL DATA

Inlet connections	2" f
Outlet connections	1" 1/2 m
Max. Flow rate	35 m3/h
Max. Delivery head	24 mts
Max Viscosity	200 CPS
Temperature PP	-5°C +65°C
Temperature PVDF	-10°C +90°C
Impeller	closed

PERFORMANCE

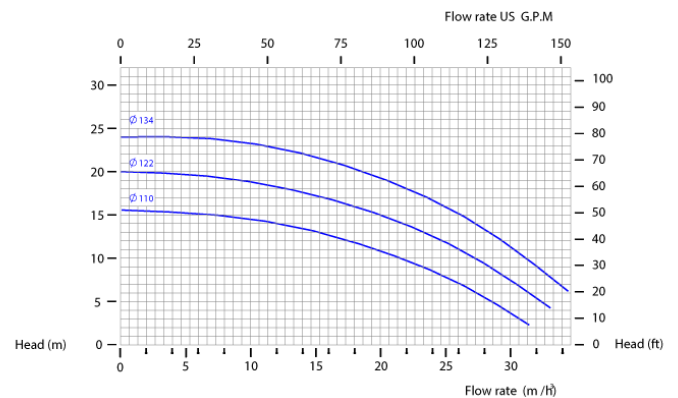

The curves and performance values refer to pumps with free delivery outlet with water at 20 °C, and two poles motor 50 Hz

SPECIFIC GRAVITY TABLE

IMPELLER	2,2 KW	3 KW
ø 134 mm	up to 1,1	up to 1,3
ø 122 mm	up to 1,3	up to 1,5
ø 110 mm	up to 1,8	up to 2

MOTOR SPECIFICATION

SIZE	Kw	RPM
IEC 90	2,2	2 poles - 2900
IEC 90	3	2 poles - 2900

DIMENSIONS

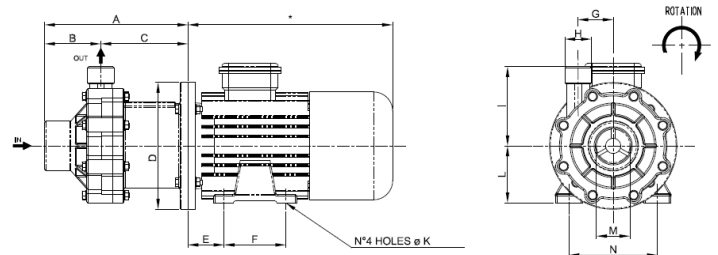

A	B	C	D	E	F	G	H	I	L	M	N	K
278	91	187	200	56	100	66,5	1-1/2"	140	90	2"	140	10

*Depend on the manufacturer

COMPOSITION

MODEL	CASING	O RING	BUSHING + SHAFT	IMPELLER	CONNECTIONS	MOTOR	MOTOR POWER
CM30	P = PP K = PVDF	D = EPDM V = VITON	TA = PTFEC + ALLUMINA 99,7%	134 = ø 134 mm STD 122 = ø 122 mm 110 = ø 110 mm	1 = BSP STD 2 = FLANGED	IE = 3PH STD X = ATEX - = NO MOTOR	2,2 = 2,2 Kw STD 3 = 3 Kw



ACCESSORIES



BASKET STRAINER FILTERS IN PP

Installed on the suction of the pumps, protects them from suspended solids and impurity.



REINFORCED PVC HOSE

With metal reinforcement for suction/discharge, also food-grade.



INOX TROLLEY

It makes pumps transportable.



FOOT BALL VALVE

Realized in PP and PVDF. Size available 1" - 1"1/4 - 1"1/2 - 2" Used to prevent the suction hose from emptying.



ANTI VIBRATION FEET KIT

Reduces physical vibration from AODD pump operation.



VALVES FITTINGS WAND CONNECTIONS IN PP, PVC, INOX



PP, PVDF, ALU SS NOZZLE

Dispenser to delivery control and batching.



FLANGE CONNECTION KIT

It modifies a pump with BSP connection into a flanged pump.

fluimac[®]

pump solution



FLUIMAC S.r.l.

Via Ticino 2 / 4
21043, Castiglione Olona (VA) - Italy
Tel.:+39 0331 866688
Fax:+39 0331 864870

www.fluimac.com
info@fluimac.com



AUTHORIZED PARTNER:

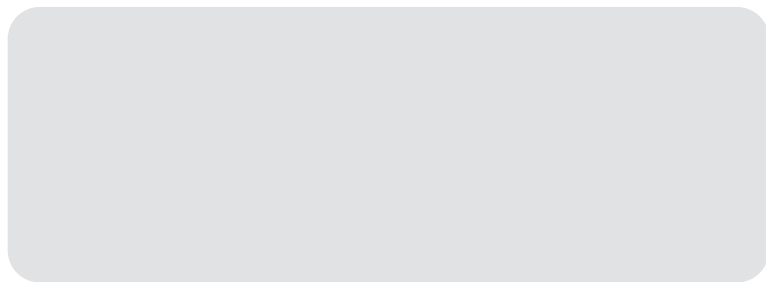

*Made in
Italy*

