

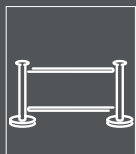

Creative Display Solutions

The Display Handbook 2024

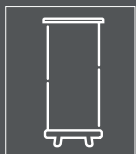

A creative solution for every need

Create greater brand awareness and stand out from the crowd

We are the largest Trade-Only manufacturer and supplier of Creative Display Solutions across Europe, selling through a global network of partners. With over 25 years' experience in delivering a complete range of creative display products, we offer everything from portable display stands and lightboxes through to customised modular exhibition systems.

We provide high-quality, innovative visual communication solutions to commercial printers, marketing agencies, exhibition contractors, and more. Our wide range of display options offers the ideal platform for delivering attention-grabbing brand messaging that adds real value for their clients.



Best seller



1 Year hardware guarantee



5 Year hardware guarantee



Comes with bag



Illuminated product



Available for use outdoors



Custom sizes available



Made in Europe



Use with fabric graphic



Use with PVC graphic



Use with self-adhesive graphic



Use with rigid panel graphic



Direct printing onto hardware



Contents

Sustainable Creative Display Solutions	4
A solution for every requirement	6
New Product Fastframe™	8
Lightboxes	10
Illuminova™	12
Illumigo™	17
Display Stands	20
Modulate™	23
Vector	34
Fastframe™	53
Arena Structures	66
Hanging structures	70
Display Blackwalls	72
Pop-up backwalls	74
Fabric tube walls	80
Tension walls	82
Display Banners	84
Tension textile systems	86
Tension banners (X Banner)	88
Display Signs	89
Free-standing signs	91
Wall mounted signs	95
Suspended signs	96
Flag Banner	97
Free-standing flags	99
Post / wall mounted flags	103
Mobile flags	104
Tents	105
Pop-up tents	107
Inflatable tents	109
Counters	111
Promotional counters	113
illuminated promotional counters	116
Barriers	117
Pedestrian control barriers	119
Ancillaries	121
Literature holders (standard)	123
Lighting	124
Lighting ancillaries	126
Portable transportation cases	127
Custom projects and made to measure graphics	130
Applications	131



Sustainable Creative Display Solutions

For Environmentally conscious brand messaging

We are dedicated to minimizing our environmental impact. We have made substantial strides in our sustainability journey and remain committed to addressing the challenges ahead as we strive to go even further. By focusing on product, premises, and people, our three- tiered approach empowers us to make impactful changes towards our environmental goals.

Product

People

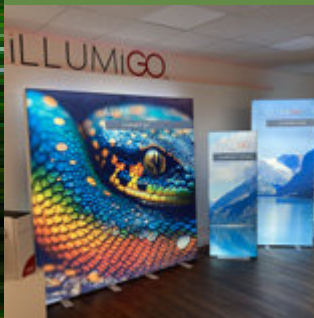

Premises

Andrew Grene Foundation | Transforming lives in Haiti

Products

From product development, through to sourcing, shipping and production, our NPD team review and challenge each stage of the process, to drive the environmental agenda.

- **Standard printed media:** Using recyclable and recycled materials such as polyester across our product portfolio in place of PVC, with increased use of cardboard for retail solutions.
- **Packaging:** Eliminating unnecessary single-use plastic packaging, emphasising tightly wrapped cardboard for efficient shipping and minimal storage space.
- **Custom media:** Offering a range of bespoke material solutions such as lightboxes with polyester sourced from plastic bottles.
- **Hardware:** A greater focus on aluminium, which is seen as a green metal.
- **Shipping:** Working with responsible distribution partners whose values align with ours.
- **Reusable products:** Our modular exhibition solutions can be reconfigured and regraphiced for multiple applications as a greener alternative to single use “build and burn” exhibition structures.

Premises

Incorporating energy efficiency into a thoughtfully designed work environment to enhance the well-being of both our staff and customers.

- **Zero to landfill:** Implemented waste management streams across a range of materials to eradicate the need for landfill.
- **Energy saving initiatives:** Adding motion activated LED lights and smart heating throughout.
- **Electric car charging ports:** Available for customers and staff to use.
- **Solar panels:** We have 629m² on our UK head office.
- **Printing equipment:** Using cutting edge systems with water based inks and LED curing technology.

People

Doing our bit to our bit to improves the lives of those in our community or chose causes. From supporting local food banks through to sponsoring football kits for school children, we are active in giving back to the local area.

- **Andrew Green Foundation:** Following the earthquake in Haiti in January 2010, the foundation was set up to transform the lives of those affected.

Initiatives detailed relate to our UK Head Office, and may vary across our European sites



A solution for every requirement

Our comprehensive range of Creative Display Solutions

We're proud to be the European market leader for Creative Display Solutions. Our goal is to offer a comprehensive range of innovative products for a variety of industries and applications, all from a single source. This collection contains our portfolio of Creative Display Solutions including our latest products.

1 Lightboxes

Create outstanding visual impact with Back lit or edge lit LED graphics, ideal for temporary, permanent and customised application.



2 Display Stands

Complete exhibition stand solutions, incorporating hanging structures, modular stands, towers and customised stands



3 Display Backwalls

Large format graphic backdrops ideal for conferences, promotional activities and events



4 Display Banners

Portable display options, ideal for temporary deployment



5 Display Signs

Professional wall, floor and suspended signage solutions



6 Flag Banners

Attract attention at a distance through movement with eye-catching flag solutions



7 Tents

Perfect temporary shelters, pop-up shops and market stall for outdoor use



8 Counters

Adaptable and portable temporary counters for promotional, display and exhibition applications



9 Barriers

Easy and convenient barrier systems to manage queues, control crowds and create temporary areas



10 Ancillaries

Accessories designed to increase the functionality of a chosen product range



NEW
PRODUCT

Introducing your **innovative**
and **cost-effective** modular
Display Solution.



For more information see pages 60-71

FASTFRAME™ is a unique, **sustainable** and **user-friendly** Display Solution.



More versatile than a pop-up

- Highly configurable
- Seamless graphics
- Easy to change Silicone Edge Graphics (SEG)
- Many applications



More flexible than a roller banner

- Assembled in seconds
- Lightweight, highly portable
- One frame, multiple graphics
- Single or double-sided graphics
- Expandable, no joints
- Washable stretch fabric
- Cost savings through repeated use



More configurable than an exhibition stand

- Expandable – add modules over time
- Quick change design
- Excellent space utilisation
- Toolless construction
- Seamless graphic overlay





Lightboxes

For outstanding visual impact in interior spaces, lightboxes are the perfect option. Vibrant graphics, edge lit or Back lit with energy saving LEDs, create focal points that add depth and drama to retail spaces, exhibition stands, commercial properties and beyond.

Whether wall mounted, free-standing or suspended at height, LED lightboxes are the ideal showcase for brand messaging and statement imagery.

We offer two ranges of lightbox solutions. The Illuminova™ range combines vivid SEG fabric graphics with a sleek profile in a choice of standard or custom dimensions. For instant pop-up displays, our portable Illumigo™ range is available in a variety of standard sizes to bring your retail space to life.

illumiNOVA™

The Illuminova™ range encompasses wall mounted, hanging and free-standing LED lightboxes in a choice of standard or custom sizes. Ideal for adding visual interest to feature walls and shop windows as well as transforming areas with low ambient lighting. Easily refreshed with updated graphics, Illuminova™ provides the perfect framework to display enhanced vibrant messaging.

iLLUMiGO™

The Illumigo™ LED lightbox range combines stunning graphic illumination with instant, tool-free assembly. For ease of transportation and storage, the aluminium LED frames are lightweight and come in a handy carry case. Simply update the SEG graphics, for a fresh and sustainable way to transform spaces with light.



30mm Illuminova™ wall mounted



With its sleek and narrow profile, the 30mm Illuminova™ LED Back lit wall-mounted lightbox is ideal for showcasing standout messaging in interior displays. Illuminated using a powerful linkable LED display system for consistent lighting across the graphic. Available in standard and custom sizes



Material	Aluminium
Profile width	30 mm
Profile Colour	Anodised Silver
Assembly	Connectors assemble using Allen key
Mounting	Wall mounted
Graphic area	Single-sided
Graphic attachment	Silicone Edged Graphics (3 mm silicone)
LED System	Back lit

• Available fully assembled or in Kit form

illuminova™ 30mm 594x854mm	ILLNO-30-05X08	Ⓞ 594(w) x 854(h) x 30(d) mm
illuminova™ 30mm 854x1189mm	ILLNO-30-08X11	Ⓞ 854(w) x 1189(h) x 30(d) mm
illuminova™ 30mm 1000x1000mm	ILLNO-30-10X10	Ⓞ 1000(w) x 1000(h) x 30(d) mm
illuminova™ 30mm 2000x1000mm	iLLNO-30-20X10	Ⓞ 2000(w) x 2000(h) x 30(d) mm



Back lit panels

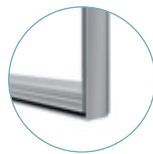

30mm profile

75mm Illuminova™ wall mounted



Create a striking focal point with the 75mm Illuminova™ LED edge lit wall mounted lightbox. Available in standard and custom sizes, the linkable LED lighting system delivers consistent lighting for a dramatic visual display.



Material	Aluminium
Profile width	75 mm
Profile Colour	Anodised Silver or custom White or Black
Assembly	Connectors assemble using Allen key
Mounting	Wall mounted
Graphic area	Single-sided
Graphic attachment	Silicone Edged Graphics (3 mm silicone)
LED System	Edge lit + Pre-installed LED lighting

illuminova™ 75mm wall mounted 1000x1000mm	iLLNO-75-10X10	⊗ 1000(w) x 1000(h) x 75(d) mm
illuminova™ 75mm wall mounted 1500x1500mm	iLLNO-75-15X15	⊗ 1500(w) x 1500(h) x 75(d) mm
illuminova™ 75mm wall mounted 2000x1000mm	iLLNO-75-20X10	⊗ 2000(w) x 1000(h) x 75(d) mm
illuminova™ 75mm wall mounted 2000x2000mm	iLLNO-75-20X20	⊗ 2000(w) x 2000(h) x 75(d) mm
illuminova™ 75mm wall mounted 3000x2000mm	iLLNO-75-30X20	⊗ 3000(w) x 2000(h) x 75(d) mm



Cable system



LED strip lighting



Numbered system for
easy assembly

100mm Illuminova™ Free-standing



The double-sided 100mm Illuminova™ LED edge lit free-standing lightbox creates a dramatic visual statement for your interior displays. The plug and play linkable LED display system makes for a simple set up, whilst the SEG graphics can be easily replaced to support new messaging.

Material	Aluminium
Profile width	100 mm
Profile Colour	Anodised Silver
Assembly	Connectors assemble using Allen key
Graphic area	Double-sided
Mounting	Free-standing
Graphic attachment	Silicone Edged Graphics 3mm (SEG)
LED System	Pre-installed LED lighting + edge light

illuminova™ 100MM 3000X2000MM	ILLNO-100-30X20	Ⓜ 3000(w) x 2007(h) x 550(d) mm
-------------------------------	-----------------	---------------------------------

Measurements include feet



Available in standard and custom sizes

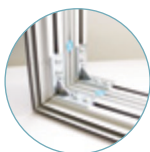

Mitred sections assemble with screw-in connectors



Cable system



LED strip lighting

125mm Illuminova™ Free-standing



For outstanding visual impact, the robust double-sided 125mm Illuminova™ LED edgelit free-standing lightbox is a must. Available in standard and custom sizes, the plug and play linkable LED display system ensures vibrant lighting across the SEG graphic.

Material	Aluminium
Profile width	125 mm
Profile Colour	Anodised silver or custom white or black
Assembly	Connectors assemble using Allen key
Double-sided	Double-sided
Mounting	Free-standing
Graphic attachment	Silicone Edged Graphics 3mm (SEG)
LED System	Pre-installed LED lighting + edge light

illuminova™ 125mm 3000x2500mm	ILLNO-125-30X25	Ⓞ 3000(w) x 2507(h) x 550(d) mm
illuminova™ 125mm 4000x2000mm	ILLNO-125-40X20	Ⓞ 4000(w) x 2007(h) x 550(d) mm

Measurements include feet

Available in standard and custom sizes



Cable system



LED strip lighting



Mitred sections assemble with screw-in connectors

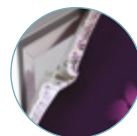

Graphic attaches with silicone edging (SEG)

125mm Illuminova™ Hanging Structure



Ideal for exhibitions and retail venues, the 125mm Illuminova™ hanging LED structure is the perfect medium for brand messaging and wayfinding. Sleek, yet lightweight and robust, the double-sided aluminium frame is edge lit with energy efficient LEDs for an eye-catching suspended display. Available in standard and custom sizes, this vibrant lightbox creates the perfect backdrop for dynamic SEG graphics.

Material	Aluminium
Profile width	125 mm
Profile Colour	Anodised. White and black are available as custom
Assembly	Sling (cables not included). Connectors assemble using Allen key
Double-sided	Double-sided
Mounting	Hanging
Graphic attachment	Silicone Edged Graphics 3mm (SEG)
LED System	Pre-installed LED lighting + edge light

illuminova™ 125mm hanging 2500x1000mm	ILLNOH-125-25X10	⊗ 2500(w) x 1000(h) x 125(d) mm
illuminova™ 125mm hanging 3500x1000mm	ILLNOH-125-35X10	⊗ 3500(w) x 1000(h) x 125(d) mm
illuminova™ 125mm hanging 5000x1250mm	ILLNOH-125-50X12	⊗ 5000(w) x 1250(h) x 125(d) mm



Cable system



LED strip lighting

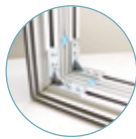

Mitred sections assemble with screw-in connectors

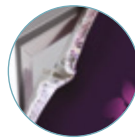

Graphic attaches with silicone edging (SEG)



Illumigo™ One



Illumigo™ One is a vibrant portable single-sided lightbox with the option to have a rear-facing textile graphic unit. Standing 2000mm high and 850mm wide, the slim 60mm profile has a white powder coated finish and benefits from tool-free plug and play assembly due to an easy to follow numeric system, rollable LED panel and pre-assembled twist-out feet.

Material	Aluminium
Profile width	60 mm
Profile Colour	White
Assembly	Tool-free
Graphic area	Single-sided
Graphic attachment	Silicone Edged Graphics (3 mm silicone)
Application	Self-supporting with pivoting feet fixed to the structure
Transport	Protective box with carry handle

Illumigo™ One	ILLGO-ONE-EU	Ⓞ 850(w) x 2010(h) x 390(d) mm
---------------	--------------	--------------------------------

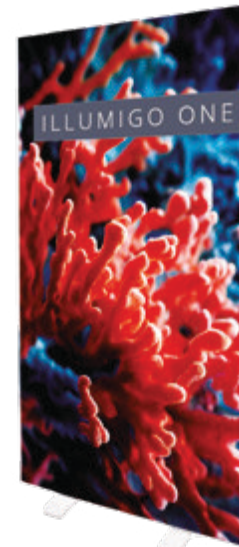

Tool-free assembly

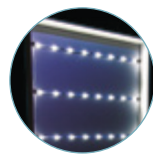

Rollable LED panel

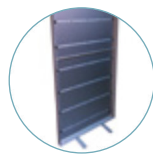

Single-sided frame



Optional Illumigo™ bag



Illumigo™



Illumigo™ is an innovative portable LED lightbox that comes in a protective compartmented box with handle for ease of transportation. Deploys tool-free in minutes thanks to pre-assembled LED lighting and push-fit optional dye-sublimated graphics.

Material	Aluminium
Profile width	100 mm
Profile Colour	White
Assembly	Tool-free
Graphic area	Double-sided
Graphic attachment	Silicone Edged Graphics (3 mm silicone)
Application	Self-supporting with pivoting feet fixed to the structure
Transport	Protective box with carry handle

Illumigo™ - 2x1	ILLGO-2X1-EU	Ⓞ 1000(w) x 2000(h) x 400(d) mm
Illumigo™ bag	ILLGO-BAG	Ⓞ 460(w) x 1160(h) x 400(d) mm



Supplied with twin twist-out feet



Numbered system for easy assembly



Pre-installed LED lights



Branded protective compartmented box



Optional Illumigo™ bag

Illumigo™ Retail



Illumigo™ Retail is an innovative portable LED lightbox that is specifically designed for retail environments because of its size and stability. The 1600 x 600mm double-sided illuminated display comes in a protective compartmented box with handle for ease of transportation. Deploys tool-free in minutes thanks to pre-assembled LED lighting and push-fit optional dye-sublimated graphics.



Material	Aluminium
Profile width	100 mm
Profile Colour	White
Assembly	Tool-free
Graphic area	Double-sided
Graphic attachment	Silicone Edged Graphics (3 mm silicone)
Application	Self-supporting with flat base fixed to the structure
Transport	Protective box with carry handle

Illumigo™ Retail	ILLGO-RETAIL-EU	Ⓞ 600(w) x 1600(h) x 285(d) mm
------------------	-----------------	--------------------------------



Pre-installed LED lights



Connector



Branded protective compartmented box



Optional Illumigo™ bag

Illumigo™ 2x2



Illumigo™ is a complete portable 2x2m double-sided aluminium lightbox display system. Simple to deploy with tool-free assembly. Just remove from the box, twist out the feet from the base panel and use the matching numerical system to connect the remaining extrusions remembering to insert the horizontal bar. SEG graphics fit into the frame channel and the power cable inserts under the base panel. Plug and play in less than 10 minutes!



Material	Aluminium
Profile width	100 mm
Profile Colour	White
Assembly	Tool-free
Graphic area	Double-sided
Graphic attachment	Silicone Edged Graphics (3 mm silicone)
Application	Self-supporting with pivoting feet fixed to the structure
Transport	Protective box with carry handle

Illumigo™ 2x2	ILLGO-2X2-EU	Ⓞ 2000(w) x 2000(h) x 390(d) mm
---------------	--------------	---------------------------------



Metal straight connector



Numbered system for easy assembly



Illumigo™ Counter



This versatile and quick to set-up double-sided counter lightbox is a great all-rounder not only at events but in retail environments from shopping centres to pop-up shops. Part of the Illumigo™ range, the Illumigo™ Counter is easy to assemble with a two-part counter-top that secures using a pair of twist out top locators and locking screws. Building the unit is intuitive and tool-free as all the parts are numbered and simply slot together. Two optional graphics complete the look to create an impactful counter ideal for attracting attention in retail, event or exhibition environments.

Material	Aluminium 100 mm, MDF table top
Assembly	Tool-free
Collapsible	Yes
Counter top	White
Graphic attachment	Silicone Edged Graphics (3 mm silicone)
Transport	Protective box with carry handle
LED System	Led strips included

Illumigo™	ILLGO-COUNTER-EU	📏 1045(h) x 1040(w) x 420(d) mm
Illumigo™ Bag	ILLGO-BAG	📏 1160(h) x 460(w) x 190(d) mm



Optional Illumigo™ bag



Protective compartmented box



Pre-assembled LEDs in the frame



Steel side feet for stability



Display Stands

Display stands are the perfect solution for an array of different applications. From exhibitions, conferences, events, retail event zones to window displays and product showrooms; their uses are unlimited. The perfect stand will showcase and increase the opportunity to interact with existing and potential customers by creating engaging, and innovative brand promotion and messaging.

Our Display Stands range of products include hanging structures to attract interest from a distance along with versatile modular stand components to create truly contemporary and captivating exhibition spaces. The collective modular systems; Modulate™, Vector, Arena and Fastframe™, are all designed to work in unison, to deliver a re-usable and reconfigurable exhibition stand. Graphics can be easily updated, and layouts refreshed over and over again. These hard working modular solutions offer exceptional return on investment as well as a sustainable approach to creative display.

Creating an effective display stand that drives results is extremely straightforward with this collection of pre-configured solutions. Simply select a design for inspiration whilst considering floor size and parameters of price-point. For a more unique stand construction, the modular range can also be customised - incorporating precise requirements with all the benefits that modular exhibition systems offer for complete creative innovation.



Stand component systems

Modulate™

Modulate™ is the fusion between two of our original concepts: Formulate and Vector. The range is composed of various frames made of aluminium tubes, equipped with the patented magnet system: MagLink. Modulate™ provides a custom build solution through its hundreds of possible configurations using the various modules.

Vector

One of the simplest and most versatile communication solutions on the market, Vector is an aluminium frame system with a stretched fabric graphic that adapts to any environment. With a variety of different profiles, all applications are possible: suspended, wall-mounted, self-supporting, double-sided or illuminated utilising Illuminova™.

Fastframe™

A unique pre-assembled foldable framework for fast construction and endless Creative Display Solutions - the perfect seamless backdrop for visually striking SEG graphics.

Arena

Arena is a tubular aluminium gantry structure that is both extremely strong and light. The different sections can be assembled according to the space and can be covered with fabric or vinyl graphics.

Hanging Structures

Select one of our lightweight Formulate hanging structures to compliment your stand design, which uses a lightweight 30mm tubular system that can be neatly wrapped in a fabric printed graphic.

Considerations for exhibitions

Why exhibit at a trade show?

Trade shows remain the preferred communication channel for companies seeking to increase their reputation and promote their image.

The benefits of a trade show are vast and very attractive. They enable several actions to be carried out in a relatively short period of time:

- Brand positioning
- Prospecting
- Market research
- Product launches
- Building customer loyalty
- Business networking

The centrepiece: your stand

The success of any trade show depends on its cost vs quality and ROI for generating leads and meeting other sales / marketing objectives.

1. Location:

How much space? How many open sides?

2. The design:

Which media: textile, rigid, flexible panels?

Need to communicate in height: sign, extension or extension of storage room?

Do you need a storeroom to store equipment?

What kind of lighting?

3. Use:

How often?

Will it need to be scalable in shape and size? What means of transport do you have?

Will the stand be reused in another environment i.e. customer showroom, inhouse events etc.?

4. The budget :

What is the budget for the stand?

Over how many shows will it pay for itself?

The keys to success

To have a successful trade show, it is essential to:

- Set 3 to 5 objectives that will guide the marketing strategy of the event
- Ensure maximum visual impact with a quality stand that will enhance the company's image (openings, suspended communication, graphics, materials, etc.)
- Implement effective communication and promotion: before, during and after the event (emailing, invitation, social networks, stand promotion, etc.)

Why choose a modular stand?

- Lightweight and compact
- Reconfigurable
- Quick payback
- Durable
- Easy to assemble
- Standard or custom made
- Unlimited message renewal
- Ergonomically friendly

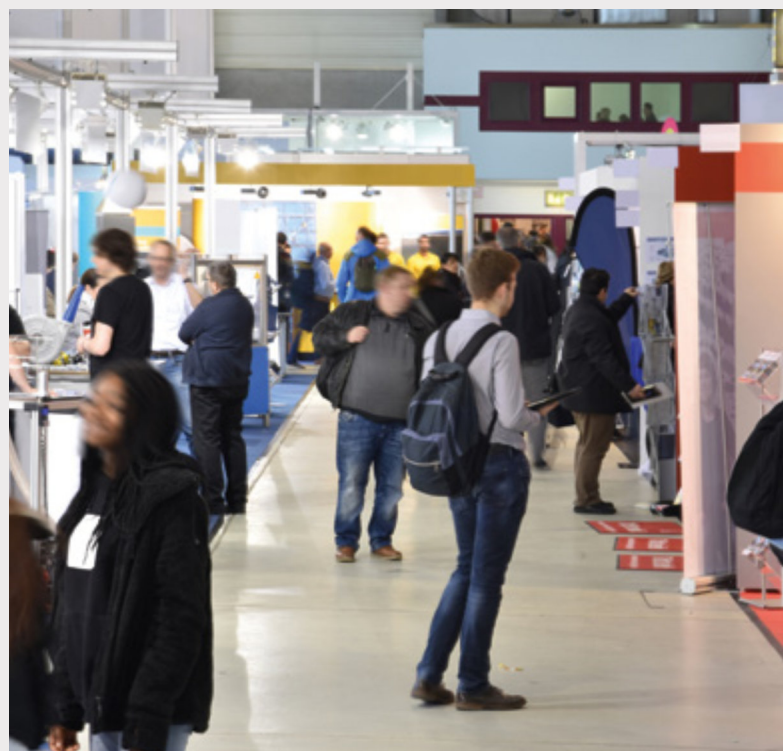

MODULATE™



Modulate™

The best way to attract attention

Modulate™ is the result of the fusion of two original concepts that have proven successful in the exhibition and retail world; Formulate tubular solutions and the modularity of Vector frames.

Modulate™ is a collection of various frames made from aluminum tubes and covered with a printed textile cover. These frames can be easily connected to each other by means of powerful magnets placed inside each structure.

Based on this simple magnetic principle, it is possible to combine the different Modulate™ frames to create configurations for all communication areas: at the point of sale, at trade shows, in exhibition areas, in shopping centres or simply within companies themselves.

MagLink connector, simple, fast and reconfigurable



Thanks to the exclusive MagLink magnetic system integrated into the structure, you can connect the frames to each other simply by bringing them together.

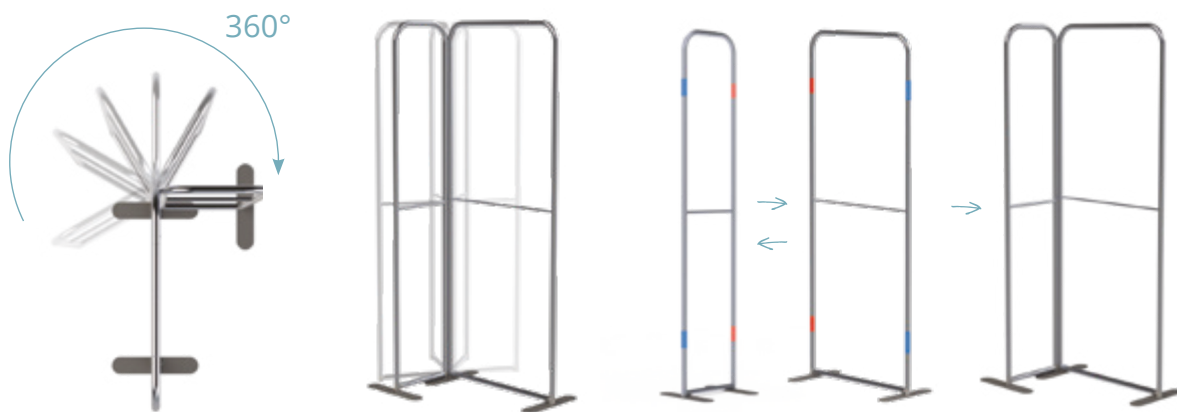

Optional 400 mm extension to change the height of the structures



MagLink connectors 360° in each post



Modulate™ carry bag with dedicated slots for feet and graphics



Intuitive marking on each section for easy assembly



Self-locking system with elastic posts and push-fit button



Rounded or straight corners with the reference MOD-SQ-ANGLE

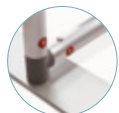

2 stabilising feet with Twist & Lock system, supplied with each frame



Central reinforcement bar (18 mm diameter)



Double-sided custom printed fabric graphic that zips closed

Tool-less assembly

Modulate™ structures are easy to assemble without tools. Each section is marked with numbers and colours and connected with push buttons. Once the structure is assembled, the Twist & Lock feet will rotate a quarter of a turn until they lock into a perfectly stable self-supporting frame. Finally pull-on the printed fabric graphic which perfectly fits to the contour of the frame.

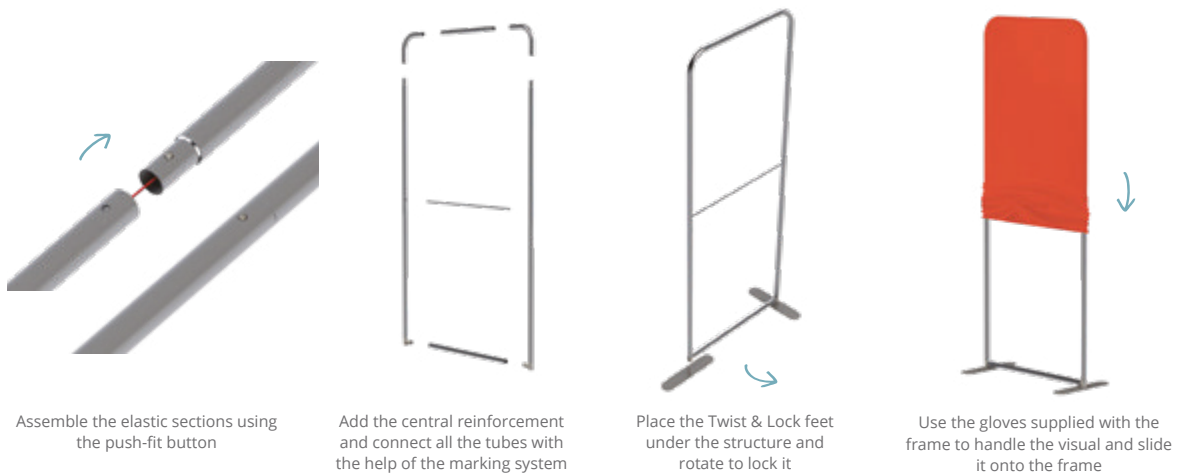

Twist & Lock Foot installation

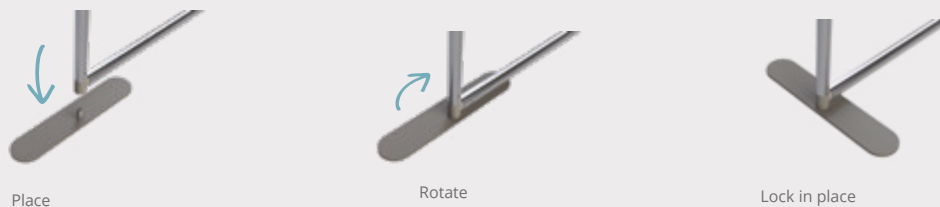

Structures with unique technological innovations!

To add versatility to Modulate™ structures, a 400 mm tubular extension can be added. With this extension, which is easily placed between two sections, you can use the same frame with two different heights.

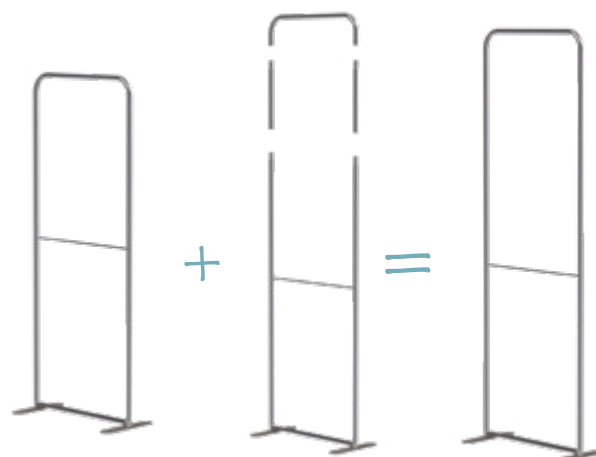

Standard Modulate™ Frames

Modulate™ is an innovative double-sided display system that consists of a set of lightweight aluminium frames covered with a custom printed tension fabric graphic. Frames connect together using powerful magnets encased inside each element and can be joined at any angle to create shaped displays or backwalls. Frames are completed by pulling a tension-fit fabric graphic over the frame and zipping at the base. Frames are available in various widths and two height options. Each frame is supplied with two stabilising feet which can be used if required for extra stability. The Modulate™ Straight frames can be used on their own or combined with other frames to create hundreds of configurations.

Material	Aluminium
Tube	30mm Ø
Assembly	Tool-free push-button connectors
Shape	Straight
Graphic area	Double-sided
Graphic attachment	Zipped tension-fit graphic
Application	Free-standing with feet (included)
Transport	Modulate™ carry bag with dedicated pockets for the feet and graphics

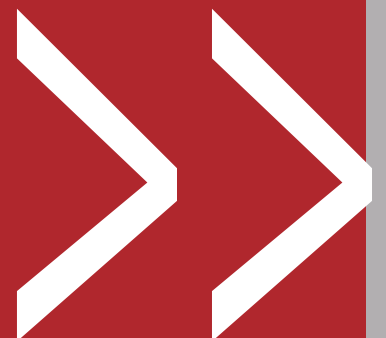

Modulate™ Straight

Modulate™ Straight 420, 424



Straight 420 rounded corners	MOD-S-420	Ⓞ 418(w) x 2000(h) x 400(d) mm
Straight 424 rounded corners	MOD-S-424	Ⓞ 418(w) x 2400(h) x 400(d) mm
Straight 420 square corners	MOD-S-420-SQ	Ⓞ 418(w) x 2000(h) x 400(d) mm
Straight 424 square corners	MOD-S-424-SQ	Ⓞ 418(w) x 2400(h) x 400(d) mm

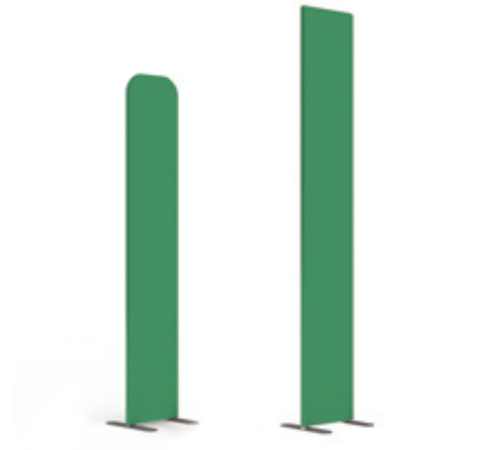

Modulate™ Straight 820, 824



Straight 820 rounded corners	MOD-S-820	Ⓞ 818(w) x 2000(h) x 400(d) mm
Straight 824 rounded corners	MOD-S-824	Ⓞ 818(w) x 2400(h) x 400(d) mm
Straight 820 square corners	MOD-S-820-SQ	Ⓞ 818(w) x 2000(h) x 400(d) mm
Straight 824 square corners	MOD-S-824-SQ	Ⓞ 818(w) x 2400(h) x 400(d) mm

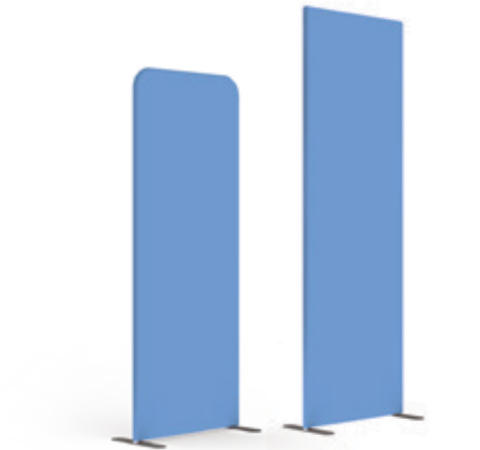

Modulate™ Straight 1020, 1024



Straight 1020 rounded corners	MOD-S-1020	📏 1018(w) x 2000(h) x 400(d) mm
Straight 1024 rounded corners	MOD-S-1024	📏 1018(w) x 2400(h) x 400(d) mm
Straight 1020 square corners	MOD-S-1020-SQ	📏 1018(w) x 2000(h) x 400(d) mm
Straight 1024 square corners	MOD-S-1024-SQ	📏 1018(w) x 2400(h) x 400(d) mm

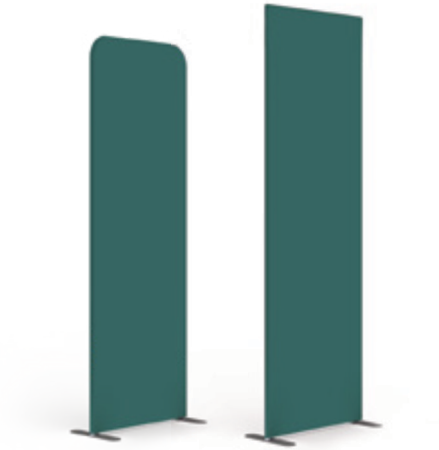

Modulate™ Straight 1820, 1824



Straight 1820 rounded corners	MOD-S-1820	📏 1818(w) x 2000(h) x 400(d) mm
Straight 1824 rounded corners	MOD-S-1824	📏 1818(w) x 2400(h) x 400(d) mm
Straight 1820 square corners	MOD-S-1820-SQ	📏 1818(w) x 2000(h) x 400(d) mm
Straight 1824 square corners	MOD-S-1824-SQ	📏 1818(w) x 2400(h) x 400(d) mm



Modulate™ Straight 2020, 2024



Straight 2020 rounded corners	MOD-S-2020	📏 2018(w) x 2000(h) x 400(d) mm
Straight 2024 rounded corners	MOD-S-2024	📏 2018(w) x 2400(h) x 400(d) mm
Straight 2020 square corners	MOD-S-2020-SQ	📏 2018(w) x 2000(h) x 400(d) mm
Straight 2024 square corners	MOD-S-2024-SQ	📏 2018(w) x 2400(h) x 400(d) mm

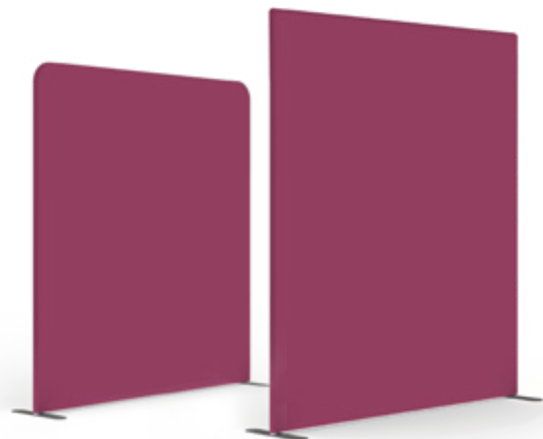

Modulate™ Slope

Modulate™ Slope



Material	Aluminium
Tube	30mm Ø
Assembly	Tool-free push-button connectors
Shape	Straight
Graphic area	Double-sided
Graphic attachment	Zipped tension-fit graphic
Application	Free-standing with feet (included)
Transport	Modulate™ carry bag with dedicated pockets for the feet and graphics

Slope 1	MOD-SS-824-01	818(w) x 2300(h) x 400(d) mm
Slope 2	MOD-SS-824-02	818(w) x 2400(h) x 400(d) mm



Slope 1

Slope 2

Modulate™ Door



The Modulate™ Door frame joins magnetically to other frames in the Modulate™ range and is tool-free in its design. Constructed from lightweight aluminium tubing with magnets held in the frames to join backwalls together. Complete with optional tension-fit fabric graphic, the door is ideal for store room areas or meeting rooms.

Material	Aluminium
Tube	30mm Ø
Assembly	Tool-free push-button connectors
Shape	Straight
Graphic area	Double-sided
Graphic attachment	Zipped tension-fit graphic
Application	Free-standing with feet (included)
Transport	Modulate™ carry bag with dedicated pockets for the feet and graphics

Modulate™ door Rounded corners	MOD-S-DOOR-820	800(w) x 2000(h) x 120(d) mm
	MOD-S-DOOR-824	800(w) x 2400(h) x 120(d) mm
Modulate™ door Square corners	MOD-S-DOOR-820-SQ	800(w) x 2000(h) x 120(d) mm
	MOD-S-DOOR-824-SQ	800(w) x 2400(h) x 120(d) mm



2 handles and 1 stop for Modulate™ door included



An adjustable foot included



2 Twist & Lock square feet



The Modulate™ Door can be used with either a left or right-hand handle

Modulate™ ancillaries

Modulate™ Half Feet (pair)

MOD-HALF-FOOT-P	⊗ 80(w) x 6(h) x 215(d) mm
-----------------	----------------------------



Modulate™ Feet (pair)

MOD-FOOT-P	⊗ 80(w) x 6(h) x 400(d) mm
------------	----------------------------



Modulate™ 400mm Extension Kit

MOD-EXT400MM	⊗ 3 tubes 400(h) x 30 (Ø) mm
--------------	------------------------------



Spotlight Clamp for Formulate / Modulate™ Tube

US903	⊗ 48(w) x 32(h) x 50(d) mm
-------	----------------------------



Modulate™ Counter



Modulate™ Counter consists of an innovative aluminium tubular frame, counter-top, and printed tension fabric graphic. Powerful magnets encased inside the frame enables two or more counters to connect using simple magnetic principles. The counter can be used on its own or combined to make a long reception or bar area. Modulate™ Counter can be deployed in minutes, thanks to the tool-less construction. The printed tension fabric graphic will either sit on or under the counter-top to suit the application.

Material	Ø 30mm Aluminium tubes, MDF tabletop/shelf
Assembly	Push-fit button
Collapsible	Yes
Counter top	Black
Shelves	1 (Optional)
Graphic attachment	Zip system
Transport	One padded carry bag, internal flap

Modulate™ Counter	FORM-MOD-CNTR	⊗ 1015(h) x 800(w) x 600(d) mm
Shelf	FORM-MOD-CNTR-02	⊗ 9(h) x 770(w) x 571(d) mm

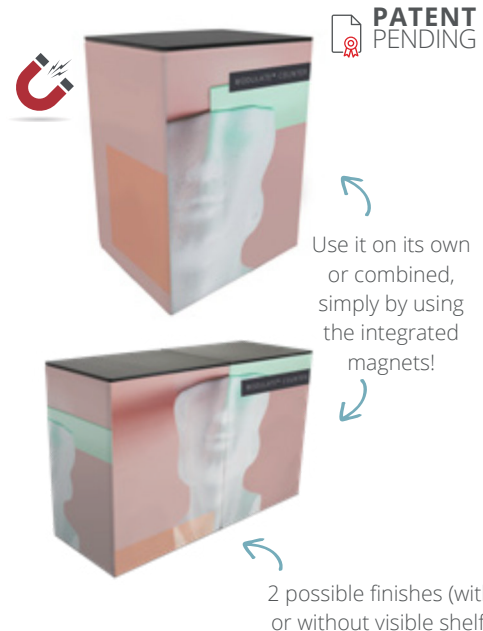

Pre-configured Modulate™ stand examples

This section showcases examples of various pre-configured Modulate™ Stands that can be achieved using the various Modulate™ hardware and ancillaries.

Modulate™ Stand 9m²



Material	Aluminium
Tube	30mm Ø
Assembly	Tool-free push-button connectors
Graphic area	Double-sided
Graphic attachment	Zipped tension-fit graphic

Straight 2024 square corners (x2)	MOD-S-2024-SQ
Straight 824 square corners (x3)	MOD-S-824-SQ
Door Modulate™	MOD-S-DOOR-824-SQ
Pair of half flat feet (x2)	MOD-HALF-FOOT-P
Modulate™ counter	FORM-MOD-CNTR
Internal shelf	FORM-MOD-CNTR-02

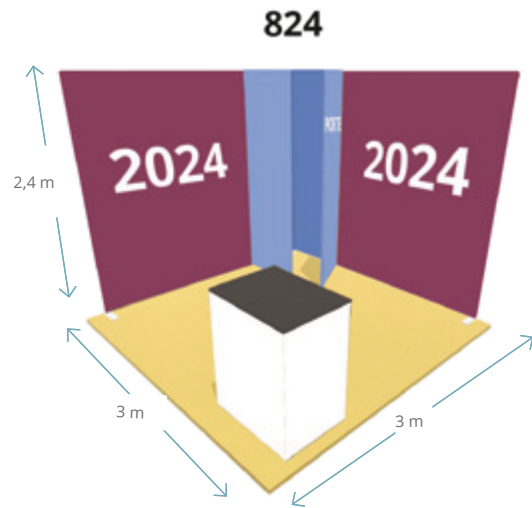

Modulate™ cupboard
perfect for storage

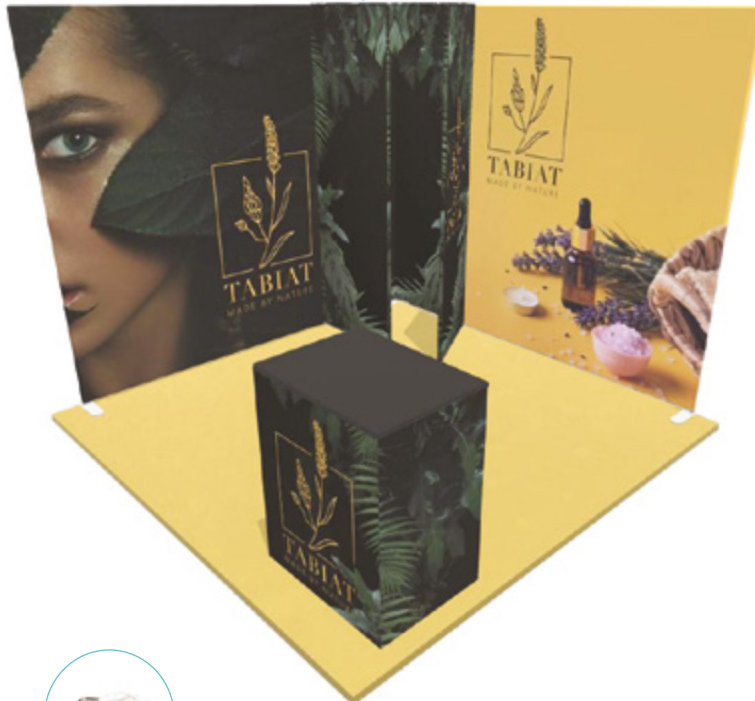

Optional Spot LED-STRIP-ARM-BDLK

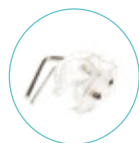

Clamp US903



Supplied with product bags

Modulate™ Stand 12m²



Material	Aluminium
Tube	30mm Ø
Assembly	Tool-free push-button connectors
Graphic area	Double-sided
Graphic attachment	Zipped tension-fit graphic

Straight 2024 square corners (x3)	MOD-S-2024-SQ
Straight 1024 square corners	MOD-S-1024-SQ
Straight 824 right angles (x4)	MOD-S-824-SQ
Modulate™ Door	MOD-S-DOOR-824-SQ
Pair of half flat feet x4	MOD-HALF-FOOT-P



Possibility to add PS950-1000-LED-BDLK spotlights



Half feet Twist & Lock MOD-HALF-FOOT-P grey



2 handles and 1 stop for Modulate™ Door MOD-S-DOOR-SP-01 included

Modulate™ Stand 15m²



Material	Aluminium
Tube	30mm Ø
Assembly	Tool-free push-button connectors
Graphic area	Double-sided
Graphic attachment	Zipped tension-fit graphic

Straight 2024 square corners (x3)	MOD-S-2024-SQ
Straight 1024 square corners	MOD-S-1024-SQ
Straight 824 square corners (x3)	MOD-S-824-SQ
Slope 2	MOD-SS-824-02
Door Modulate™	MOD-S-DOOR-824-SQ
Pair of half flat feet x4	MOD-HALF-FOOT-P
Modulate™ counter	FORM-MOD-CNTR
Internal shelf	FORM-MOD-CNTR-02

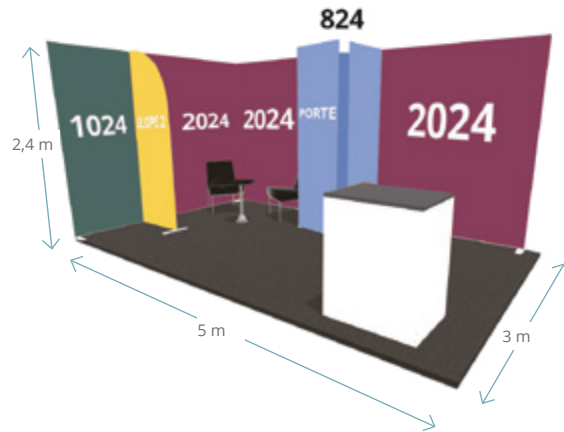

Configure the stand interior with additional Modulate™ frames



Possibility to add PS950-1000-LED-BDLK spotlights



Half feet Twist & Lock MOD-HALF-FOOT-P



Accessorise with a Modulate™ counter

Modulate™ Stand 18m²



The Modulate™ range is ideal for the design of small and medium sized exhibition stands. The assembly of Modulate™ structures is simple, without tools and allows unlimited modularity and evolution of your configurations.

Material	Aluminium
Tube	30mm Ø
Assembly	Tool-free push-button connectors
Graphic area	Double-sided
Graphic attachment	Zipped tension-fit graphic

Straight 2024 square corners (x4)	MOD-S-2024-SQ
Straight 1024 square corners	MOD-S-1024-SQ
Straight 824 square corners (x4)	MOD-S-824-SQ
Door Modulate™	MOD-S-DOOR-824-SQ



Modulate™ cupboard -door with handle (without lock)

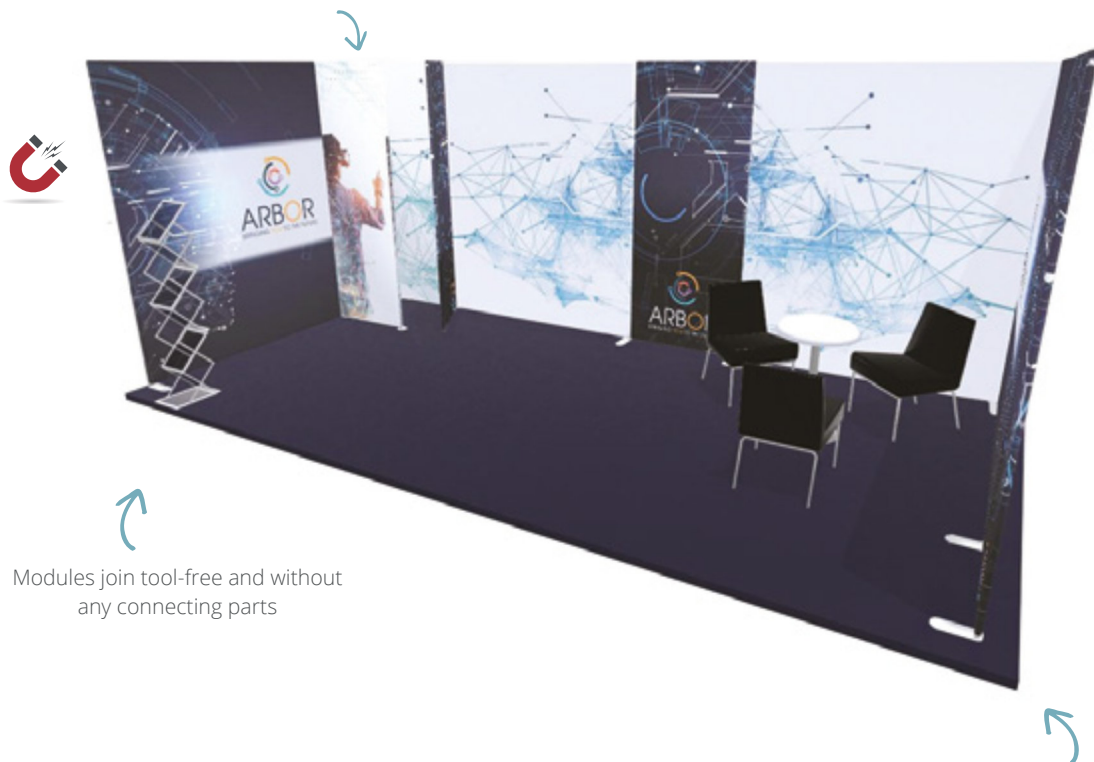

Modules join tool-free and without any connecting parts

The ease of assembly of the range allows for reconfigurable and reusable solutions: mix and match structures in an instant!

VECTOR



Vector

Visual marketing for every budget

Whether wall mounted or free-standing, the diverse range of Vector aluminium profiles provides a solution for every need and every budget.

Vector offers optimal visual impact and original designs that can be adapted to any event: showrooms, point of sale, exhibitions, museums and many others.

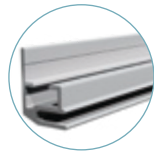

Quick Fix 20 mm



50 mm

Illuminova™ brings your Vector stand to light

Add eye-catching Illuminova™ lightbox modules to your Vector display stand. Available in 4 standard LED modules (I, J, P, and Q), both systems can be combined to create a striking mix of simplicity and illumination to your exhibition stand.

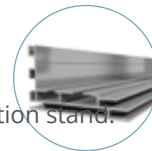

75 mm LED

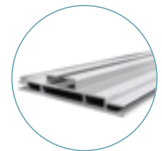

100 mm LED

Anodised aluminium profiles

The Vector and Illuminova™ modules are available in a range of aluminium profiles to suit each application. For more information, please consult the table below.



VECTOR	Wall mounted	Free-standing	Illuminated	Double-sided	Premium range	Various colours
20 mm	x					x
50 mm		x		x	x	
75 mm LED	x	x	x		x	x
100 mm LED		x	x	x		

For Illuminova™ products, please see page 18

Vector Modules

An ultra-compact solution

From free-standing textile walls to exhibition stands, the Vector range offers a versatile and adaptable solution for all your events. The Vector frame system with stretched fabric covering is one of the simplest communication solutions on the market, particularly in a stand environment. Scalable, reconfigurable, ultra-portable: go from a 9 m² to a 15 m² stand with ease. Easily create stands of all sizes and shapes and accessorise them with spotlights, counters, document holders, and anything else you need to display.

A compact solution for portability and optimised storage

Choose the Vector Modules:

- 50 mm aluminium profiles
- Different modules: walls, arches, LEDs, storage...
- Packaged in numbered sections of 1250 mm
- Delivered in a cardboard box with assembly instructions, accompanied by the visual of your choice
- In stock all year round
- Each module is already perforated on 4 sides and equipped with the necessary screws: easily assemble different modules together, one Allen key is the only tool you will need.
- Reconfigurable and reusable: store the stand at home in a small box (1350 x 400 x 300 mm)
- Excellent return on investment

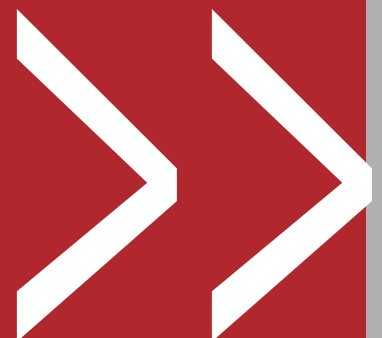

Go from a 3m² stand to a 15m² stand in the blink of an eye!

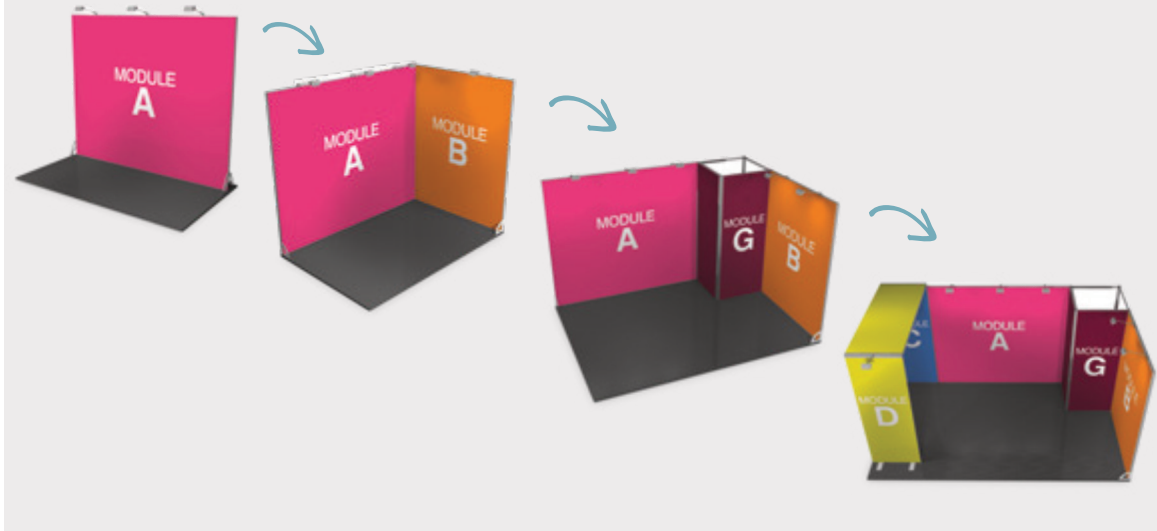

Vector Modules – Walls



Material	Aluminium
Profile width	50mm
Profile Colour Tube	Anodised
Assembly	Connectors assemble using Allen key
Graphic area	Single and double-sided
Graphic attachment	SEG 3mm

Module A	MODULE-VFF-A	⊗ 2950(w) x 2500(h) x 50(d) mm
Module B	MODULE-VFF-B	⊗ 1950(w) x 2500(h) x 50(d) mm
Module C	MODULE-VFF-C	⊗ 950(w) x 2500(h) x 50(d) mm
Module M	MODULE-VFF-M	⊗ 2850(w) x 2500(h) x 50(d) mm
Module N	MODULE-VFF-N	⊗ 1850(w) x 2500(h) x 50(d) mm
Module O	MODULE-VFF-O	⊗ 450(w) x 2500(h) x 50(d) mm
Module L	MODULE-VFF-L	⊗ 2800(w) x 2500(h) x 620(d) mm



Post Module



Material	Aluminium
Profile width	50mm
Profile Colour Tube	Anodised
Assembly	Connectors assemble using Allen key, Screw-in strips

Module E	MODULE-VFF-E	⊗ 50(w) x 50(d) x 2500(h) mm
----------	--------------	------------------------------



illuminova™ Modules



Material	Aluminium
Profile width	75mm and 100mm
Profile Colour Tube	Anodised
Assembly	Connectors assemble using Allen key
Graphic area	Single and double-sided
Graphic attachment	SEG 3mm
LED System	Pre-installed LED lighting

Module I	MODULE-VFF-I	Ⓞ 950(w) x 2550(h) x 550(d) mm
Module J	MODULE-VFF-J	Ⓞ 950(w) x 2500(h) x 75(d) mm
Module P	MODULE-VFF-P	Ⓞ 1850(w) x 2500(h) x 100(d) mm
Module Q	MODULE-VFF-Q	Ⓞ 1850(w) x 1000(h) x 100(d) mm

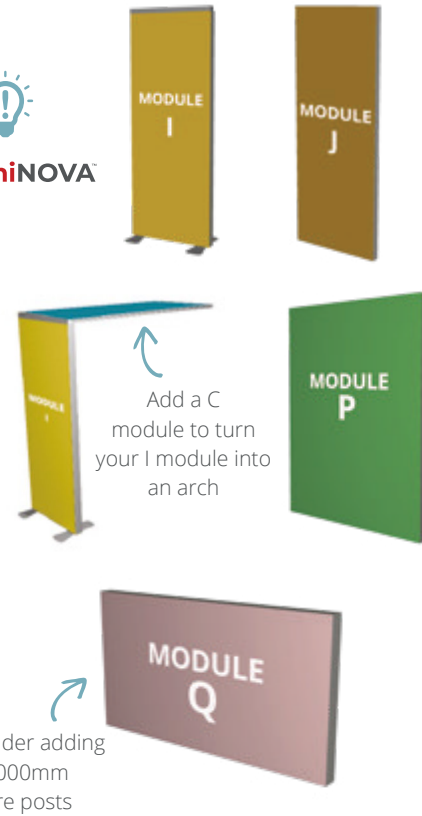

Modules Vector - Arches



Material	Aluminium
Profile width	50 mm
Profile Colour Tube	Anodised
Assembly	Connectors assemble using Allen key
Graphic area	Single and double-sided
Graphic attachment	SEG 3mm

Module D	MODULE-VFF-D	Ⓞ 2550(h) x 950(l) x 2600(p) mm
Module H	MODULE-VFF-H	Ⓞ 2550(h) x 950(l) x 2600(p) mm



Vector Modules - Storage



Material	Aluminium
Profile width	50 mm
Profile Colour Tube	Anodised
Assembly	Connectors assemble using Allen key
Graphic area	Single and double-sided
Graphic attachment	SEG 3mm

Module F - door and extension hardware	MODULE-VFF-F-2	⊕ 2500(h) x 950(l) x 50(p) mm Extension: 545 (h) x 950 (l) mm. Door: 1930 (h) x 940 (l) mm
Module G - corner storage room hardware	MODULE-VFF-G-2	⊕ 2500(h) x 1050(l) x 1050(d) mm
Module G3 - storage room hardware	MODULE-VFF-G3-2	⊕ 2500(h) x 1050(l) x 1050(d) mm



Vector Modules Extensions



Material	Aluminium
Profile width	50mm
Profile Colour	Anodised
Assembly	Connectors assemble using Allen key
Graphic area	Single or double-sided
Graphic attachment	SEG 3mm

Module K	MODULE-VFF-K	⊕ 1050(w) x 1000(h) x 1050(d) mm
----------	--------------	----------------------------------

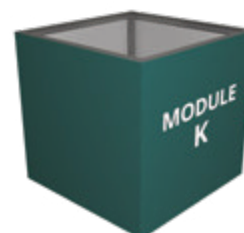

Vector standard stand designs

This section showcases examples of various pre-configured Vector Stands that can be achieved using the various Vector hardware and ancillaries.

Vector Stand 9m²



Material	Aluminium
Profile width	50mm
Profile Colour	Anodised
Assembly	Connectors assemble using Allen key
Graphic area	Single or double-sided
Graphic attachment	SEG 3mm

Module B (x2)	MODULE-VFF-B
Module G	MODULE-VFF-G-2
Pair of angled feet	SLF1P

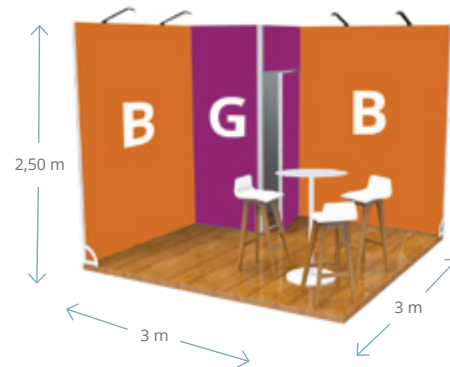

Scalable stands go from 9m² to 15m²

Screw together Module B to the corresponding post to form the desired configuration.



Possibility to add LED Exhibition Light
Code : LED-EXHIB-ARM-BDLK



Angle foot
Code: SLF1P



Return with lock and key set

Vector Stand 12m²- Design 1



Material	Aluminium
Profile width	50mm
Profile Colour	Anodised
Assembly	Connectors assemble using Allen key
Graphic area	Single or double-sided
Graphic attachment	SEG 3mm

Module C (x2)	MODULE-VFF-C
Cross bar 900 mm (x3)	LN605-900-L2
Module F	MODULE-VFF-F-2
Module V (x4)	MODULE-LN-V
Module L	MODULE-VFF-L
Module E (x2)	MODULE-VFF-E
Cross bar 950 mm (x12)	LN605-950-L2
Pair of angled feet	SLF1P

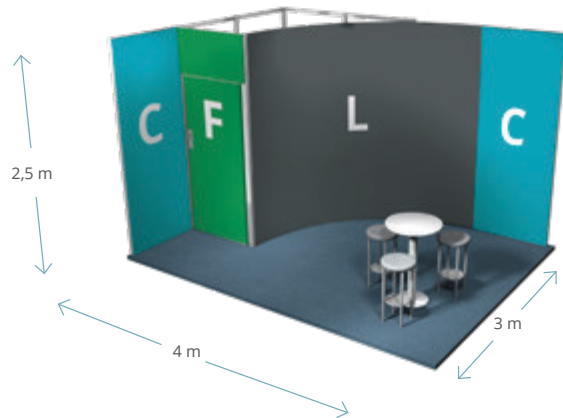

Possibility to add
LED Floodlight
Code: LED-FLOOD-ARM-BDLK



Square post to
create 90° angles



Return with lock
and key set

Vector Stand 12m² - Design 2



Material	Aluminium
Profile width	50mm
Profile Colour	Anodised
Assembly	Connectors assemble using Allen key
Graphic area	Single or double-sided
Graphic attachment	SEG 3mm

Module C	MODULE-VFF-C
Module H	MODULE-VFF-H
Module G	MODULE-VFF-G-2
Module B (x2)	MODULE-VFF-B
Pair of angled feet	SLF1P

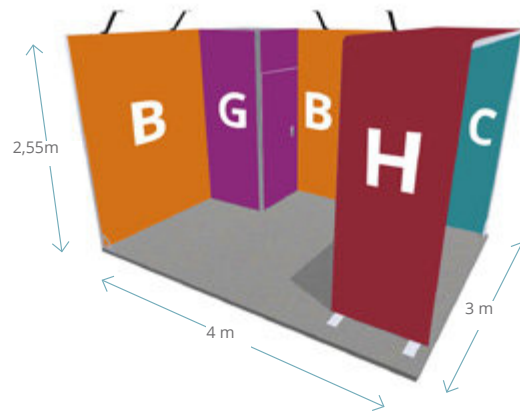

Vector graphic



Return with lock and key set

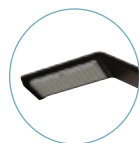

LED Exhibition Light

Vector Stand 15m² - Design 1



Material	Aluminium
Profile width	50mm
Profile Colour	Anodised
Assembly	Connectors assemble using Allen key
Graphic area	Single or double-sided
Graphic attachment	SEG 3mm

Module B (x2)	MODULE-VFF-B
Module-G3	MODULE-VFF-G3-2
Pair of angled feet	SLF1P

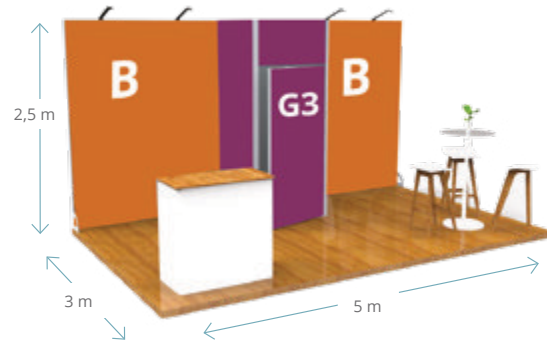

Scalable stands go from 9m² to 15m²



Square post to create 90° angles



Possibility to add LED Exhibition Light
Code: LED-EXHIB-ARM-BDLK



Return with lock and key set

Vector Stand 15m² - Design 2

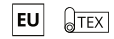

Material	Aluminium
Profile width	50mm
Profile Colour	Anodised
Assembly	Connectors assemble using Allen key
Graphic area	Single or double-sided
Graphic attachment	SEG 3mm

Module F	MODULE-VFF-F-2
Module B (x3)	MODULE-VFF-B
Module C (x3)	MODULE-VFF-C
Module J	MODULE-VFF-J
Module O	MODULE-VFF-O
Module E (x6)	MODULE-VFF-E
Module K	MODULE-VFF-K
Pair of angled feet	SLF1P

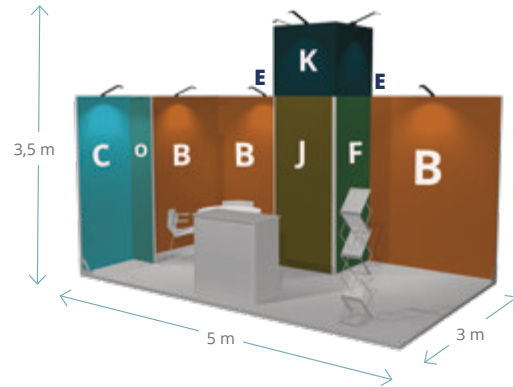

Module LED

Using a J-Module is a great way to add light to your stand and get noticed

Raise the backwall

Gain visibility and originality with this large reserve that can be personalised on all 4 sides



Square post to create 90° angles



Possibility to add LED Exhibition Light
Code: LED-EXHIB-ARM-BDLK



Return with lock and key set

Vector Stand 18m²

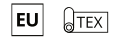

Material	Aluminium
Profile width	50mm
Profile Colour	Anodised
Assembly	Connector with Allen key
Graphic area	Single or double-sided
Graphic attachment	SEG 3mm

Module G	MODULE-VFF-G-2
Module B (x3)	MODULE-VFF-B
Module C	MODULE-VFF-C
Module H	MODULE-VFF-H
Illuminova™ 125mm hanging 1000 x 2500mm	iLLNOH-125-25X10
Pair of angled feet	SLF1P

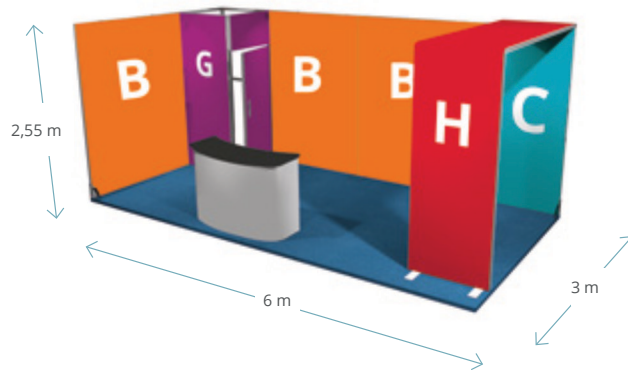

illuminova™



Rounded corner for a full graphic



Return with lock and key set

Vector Stand 24m²



Material	Aluminium
Profile width	50mm
Profile Colour	Anodised
Assembly	Connectors assemble using Allen key
Graphic area	Single or double-sided
Graphic attachment	SEG 3mm

Module B (x2)	MODULE-VFF-B
Module N (x2)	MODULE-VFF-N
Module D (x2)	MODULE-VFF-D
Module C	MODULE-VFF-C
Module F	MODULE-VFF-F-2
Module E (x4)	MODULE-VFF-E
Module Q	MODULE-VFF-Q
Posts (x2) 1000 mm	LN616-CUSTOM-M
Pair of angled feet	SLF1P

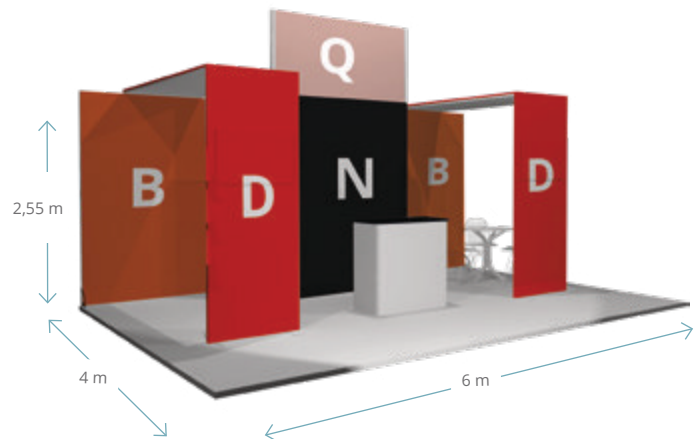

VECTOR

Vector free-standing module configurations and ancillaries

3m Wall



Material 50 mm aluminium profile frame
Graphic Fabric graphic with 3mm SEG

Module A (x1)	MODULE-VFF-A
Pair of half-moon feet	LN155



Ideal for creating large picture walls or partitions



6m Wall



Module A (x2)	MODULE-VFF-A
Flat feet (x4)	LN155



Enhance engagement!
Attach LED spotlights to your free-standing frames to make graphics bright and eye-catching



Assemble several modules to create very large picture walls



Stabilising feet
For optimal stability of your structures, add feet at regular intervals.

Vector Modules ancillaries

Quick-fix Mounting Bracket

For hanging frames on shell schemes

Mounting bracket | LN134



Quarter Side Feet (pair)

SLF1P | 220(h) x 220(w) x 5(d) mm



Flat Foot for retail

Metal foot for free-standing frames
Available colour: Silver

FX295 | 7(h) x 180(w) x 550(d) mm



Flat Foot

Metal foot for free-standing frames

LN155 | 7(h) x 75(w) x 450(d) mm



Side flat feet (pair)

SLF4P | 100(w) x 185(h) x 450(d) mm



Custom Vector stands

The Vector range offers a versatile and adaptable solution for any event. The frame system is scalable and reconfigurable and is dressed with an optional custom printed stretched fabric graphic. The Vector range offers a versatile and adaptable solution for any event.

Vector Custom Stand 24m²

Material	Aluminium
Profile width	50mm
Profile colour	Anodised
Assembly	Connectors assemble using Allen key
Graphic area	Single or double-sided
Graphic attachment	SEG 3mm

Add a touch of originality to your VECTOR stand by integrating FORMULATE

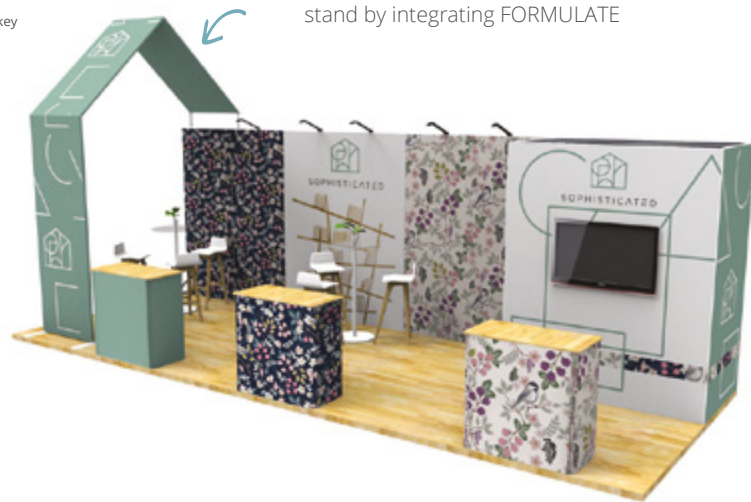

Vector Custom Stand 40m²

Material	Aluminium
Profile width	50mm
Profile colour	Anodised
Assembly	Connectors assemble using Allen key
Graphic area	Single or double-sided
Graphic attachment	SEG 3mm



Vector Custom Stand 40m²

Material	Aluminium
Profile width	50mm
Profile colour	Anodised
Assembly	Connectors assemble using Allen key
Graphic area	Single or double-sided
Graphic attachment	SEG 3mm



Vector Custom Stand 50m²

Material	Aluminium
Profile width	50mm
Profile colour	Anodised
Assembly	Connectors assemble using Allen key
Graphic area	Single or double-sided
Graphic attachment	SEG 3mm



Vector Custom Stand 60m² - Design 1

Material	Aluminium
Profile width	50mm
Profile colour	Anodised
Assembly	Connectors assemble using Allen key
Graphic area	Single or double-sided
Graphic attachment	SEG 3mm



Vector Custom Stand 60m² - Design 2

Material	Aluminium
Profile width	50mm
Profile colour	Anodised
Assembly	Connectors assemble using Allen key
Graphic area	Single or double-sided
Graphic attachment	SEG 3mm

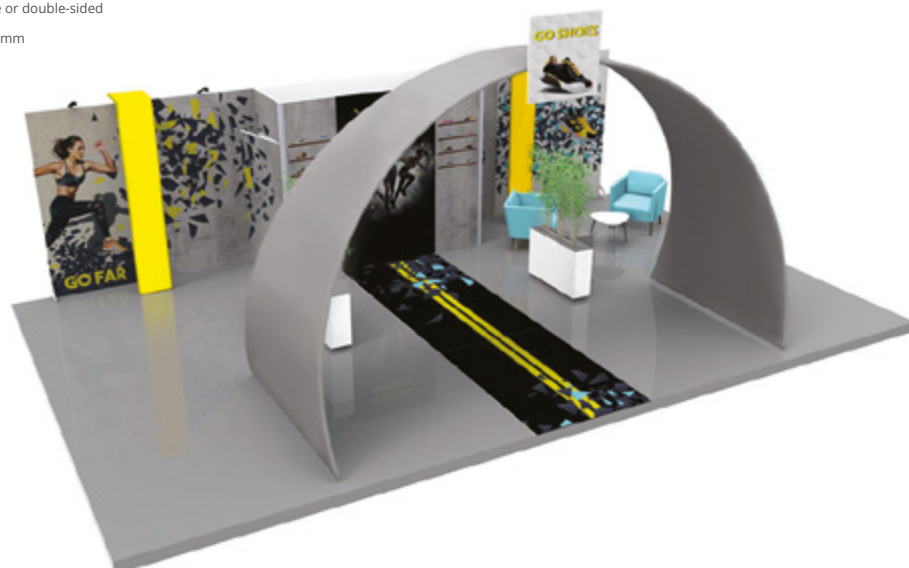

Vector Custom Stand 80m²

Material	Aluminium
Profile width	50mm
Profile colour	Anodised
Assembly	Connectors assemble using Allen key
Graphic area	Single or double-sided
Graphic attachment	SEG 3mm

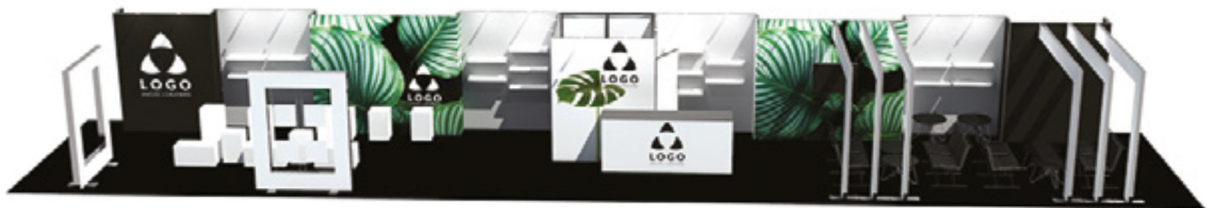
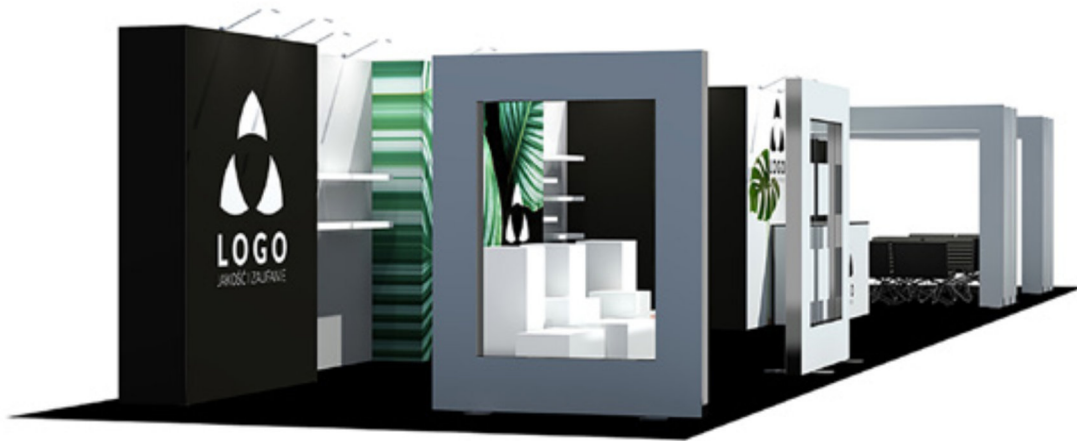

Ancillaries

Dome base (single)

LN102 |  ∅ 450 mm



Linear foot (pair)

Weights: 1,2 kg

SLF1P |  220(w) x 220(h) x 5(d) mm



Flat foot (single)

Metal for self-supporting frame

Weights: 1,75 kg

LN155 |  7(h) x 100(w) x 450(d) mm



LCD screen bracket

Mounting on post or crossbar

LN124 |  Screen 37" - 70" (94 - 177 cm)



Roll of magnetic tape

EM303 | Polarity A-30m x 4 mm



Steel tape

EM351 | 15m x 12,7 mm



Transform your space in seconds using **FASTFRAME™**



1. Folded state

The lightweight frame is pre-assembled in a convenient, portable carry bag.



2. Unfold

From its pre-assembled state, the frame can then be effortlessly unfolded and locked in place with a central support rod.

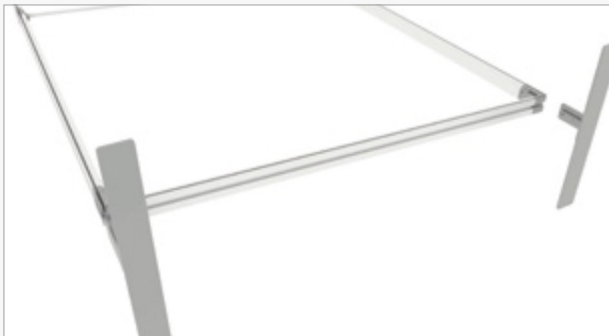

3. Components

Feet can be added if required to give additional rigidity to the frame.



4. Install graphics

Your graphics, available in a Standard or Premium finish, can then be applied to the fully assembled frame.

Sustainable exhibitions

With sustainability a key theme for event organisers and exhibitors alike, modular exhibition systems offer an environmentally conscious choice.

- » Made from aluminium, an infinitely recyclable material
- » Using polyester graphic materials which can be recycled multiple times
- » Graphics printed using water based inks
- » One system for multiple display applications



Enjoy **many benefits**, such as:

NEW
PRODUCT



An efficient tool-less frame

Unit can be constructed and ready in a short amount of time.



Lightweight and ultra slim

Unit is highly portable, making travel and storage much easier.



Seamless graphic

Apply a single graphic to connected frames to create a large seamless display.



Sustainable

Multiple use, not single use.



Interchangeable graphics

Display multiple messages time and time again.

FASTFRAME™ utilises **Silicone Edge Graphics**

- » Fabric graphics are edged with a silicone strip which slots into the channel of the frame for easy installation
- » This is more cost-effective than alternative options and can be re-used multiple times
- » The graphics are printed using water based inks which is more eco-friendly
- » Seamless graphics can be applied to the connected frames for large displays
- » Graphics can be reproduced to deliver new messages

Polyester Stretch Graphics

Stretch textile fabric, 3mm silicone edge.

Black Back Graphics

Black back textile (black out), 3mm silicone edge.

Material	Aluminium
Profile width	40 mm
Profile Colour	Silver
Assembly	Tool-free
Graphic area	Single and Double-sided
Graphic attachment	Silicone Edged Graphics (3 mm silicone)
Application	Free-standing
Transport	Fastframe™ carry bag

FASTFRAME™

FASTFRAME™ 1000x500 - 2 Pack



Fastframe™	FF-100X50	① 1000(w) x 500(h) x 40(d) mm
Fastframe™ (Black back graphic)	G-FF-100X50-BB	② 1000(w) x 500(h)
Fastframe™ (Polyester stretch graphic)	G-FF-100X50-PS	③ 1000(w) x 500(h)

**NEW
PRODUCT**



Portable carry bag



Feet can be added if required.
Feet sold separately

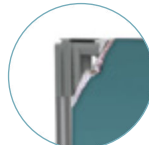

Silicone edged (SEG) graphic



FASTFRAME™ 1000x1000 - 2 Pack



Fastframe™	FF-100X100	① 1000(w) x 1000(h) x 40(d) mm
Fastframe™ (Black back graphic)	G-FF-100X100-BB	② 1000(w) x 1000(h)
Fastframe™ (Polyester stretch graphic)	G-FF-100X100-PS	③ 1000(w) x 1000(h)

**NEW
PRODUCT**



Portable carry bag



Feet can be added if required.
Feet sold separately



Silicone edged (SEG) graphic



FASTFRAME™ 1000x2000



Fastframe™	FF-100X200	Ⓞ 1004(w) x 2007(h) x 400(d) mm
Fastframe™ (Black back graphic)	G-FF-100X200-BB	Ⓞ 1000(w) x 2000(h)
Fastframe™ (Polyester stretch graphic)	G-FF-100X200-PS	Ⓞ 1000(w) x 2000(h)



Portable carry bag



Includes 2 x feet

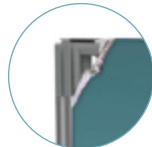

Silicone edged (SEG) graphic



FASTFRAME™ 1000x2400



Fastframe™	FF-100X240	Ⓞ 1004(w) x 2407(h) x 400(d) mm
Fastframe™ (Black back graphic)	G-FF-100X240-BB	Ⓞ 1000(w) x 2400(h)
Fastframe™ (Polyester stretch graphic)	G-FF-100X240-PS	Ⓞ 1000(w) x 2400(h)



Portable carry bag



Includes 2 x feet



Silicone edged (SEG) graphic



FASTFRAME™

FASTFRAME™ 1200x2400



Fastframe™	FF-120X240	📏 1204(w) x 2407(h) x 400(d) mm
Fastframe™ (Black back graphic)	G-FF-120X240-BB	📏 1200(w) x 2400(h)
Fastframe™ (Polyester stretch graphic)	G-FF-120X240-PS	📏 1200(w) x 2400(h)

NEW
PRODUCT

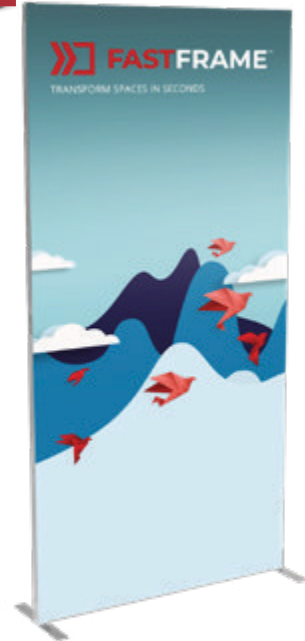

Portable carry bag



Includes 2 x feet

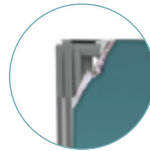

Silicone edged
(SEG) graphic

FASTFRAME™ Starter Kit



Fastframe™ Starter Kit	Price on demand	📏 1004(w) x 2007(h) x 400(d) mm
------------------------	-----------------	---------------------------------

NEW
PRODUCT



Fastframe™ Starter Kit



Portable carry
bag



1 frame
1000 x 2000mm
Includes feet



5 graphics
1000 x 2000mm

FASTFRAME™ Backwall Kit



Fastframe™ Backwall Kit	Price on demand	@ 2004(w) x 2007(h) x 400(d) mm
-------------------------	-----------------	---------------------------------



Fastframe™ Backwall Kit

- 
 Portable carry bag
- 
 2 frames
 1000 x 2000mm
 Includes feet
- 
 4 graphics
 1000 x 2000mm,
 2 graphics
 2000 x 2000mm



FASTFRAME™ Pop-up Kit







Fastframe™ Pop-up Kit	Price on demand	@ 2690(w) x 2007(h) x 940(d) mm
-----------------------	-----------------	---------------------------------



Dimensions based on configuration shown

Fastframe™ Pop-up Kit

- 
 Portable carry bag
- 
 3 frames
 1000 x 2000mm
 Includes feet
- 
 1 graphic
 2000 x 3000mm,
 3 graphics
 1000 x 2000mm
- 
 2
 45° connector kit



FASTFRAME™ Feet

Full foot (Single)

FF-FF | 50(w) x 99(h) x 400(d) mm



Middle Full Foot (Single)

FF-MFF | 50(w) x 89(h) x 400(d) mm



Half Middle Foot (Single)

FF-HFM | 51(w) x 89(h) x 220(d) mm



Small Middle Foot (Single)

FF-SMF | 40(w) x 89(h) x 97(d) mm



Side Half Feet (Pair)

FF-SHF | 50(w) x 98(h) x 220(d) mm



FASTFRAME™ Connectors

45° Connector Kit - Top & Bottom

FF-45C | 45(w) x 108(h) x 95(d) mm



90° Connector Kit - Top & Bottom

FF-90C | Top 81.5(w) x 60.7(h) x 81.5(d) mm
Bottom 81.5(w) x 60.7(h) x 81.5(d) mm



90° Middle Connector Kit - Pair

FF-90MC | 40(w) x 55(h) x 40(d) mm



90° Left Inside Connector Kit - Pair

FF-90LIC | 40(w) x 55(h) x 40(d) mm



90° Right Inside Connector Kit - Pair

FF-90RIC | 55(w) x 85(h) x 55(d) mm



Arch Connector Kit - 4 Brackets

FF-ACC | 90(w) x 105(h) x 60(d) mm



Cross Connector Kit - Top & Bottom

FF-CC | Top 142(w) x 94.3(h) x 100.7(d) mm
Bottom 141.3(w) x 90(h) x 100.4(d) mm



FASTFRAME™ Connectors and Lighting

T-Shape Connector Kit - Top & Bottom

FF-TC	Top	100.5(w) x 91(h) x 94.7(d) mm
	Bottom	100(w) x 91.1(h) x 97.4(d) mm



Y Shape Connector Kit - Top & Bottom

FF-YC	Top	107(w) x 97.3(h) x 107(d) mm
	Bottom	107(w) x 107(h) x 94.3(d) mm



2-Way Connector - Single

FF-2WC	41(w) x 82(h) x 21(d) mm
--------	--------------------------



4-Way Connector - Single

FF-4WC	150(w) x 12.12(h) x 19.6(d) mm
--------	--------------------------------



LED Exhibition Light - 2 x Lights

LED-EXHIB-ARM-BDLK	50(w) x 455(h) x 55(d) mm
--------------------	---------------------------



Fastframe™ Stand 12m²



Quick and easy to assemble and disassemble. Add energy saving LED lighting to illuminate the back walls for more standout.

Material	Aluminium and ABS/nylon
Profile width	40mm
Profile colour	Silver
Assembly	Pre-assembled folding
Graphic area	Single or double-sided
Graphic attachment	SEG 3mm

Fastframe™ 1200x2400mm	FF-120X240
Fastframe™ 1200x2400mm graphic	G-FF-120X240-BB/PS
Fastframe™ 1000x2400mm (5)	FF-100X240
Fastframe™ 1000x2400mm (5) graphics	G-FF-100X240-BB/PS
Fastframe™ middle full foot (5)	FF-MFF
LED exhibition lights (5)	LED-EXHIB-ARM-BDLK
Fastframe™ pair side half feet	FF-SHF
Fastframe™ middle half foot (2)	F-HFM
Fastframe™ 45 degree connector kit (2)	FF-45C

NEW
PRODUCT

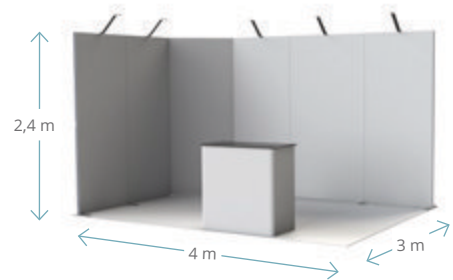

Portable carry bag



Feet can be added if required



Silicone edged (SEG) graphic

Graphics available in black back or polyester stretch, seamless graphics are available



FASTFRAME™ Counter:
Coming Soon

Fastframe™ Stand 15m²



Quick and easy to assemble and disassemble. Add energy saving LED lighting to illuminate the back walls for more stand out.

Material	Aluminium and ABS/nylon
Profile width	40mm
Profile colour	Silver
Assembly	Pre-assembled folding
Graphic area	Single or double-sided
Graphic attachment	SEG 3mm

Fastframe™ 1000x2000mm	FF-100X200
Fastframe™ 1000x2000mm graphic	G-FF-100X200-BB/PS
Fastframe™ 1200x2400mm	FF-120X240
Fastframe™ 1200x2400mm (5) graphics	G-FF-120X240-BB/PS
Fastframe™ 1000x2400mm	FF-100X240
Fastframe™ 1000x2400mm (2) graphics	G-FF-100X240-BB/PS
LED exhibition lights (5)	LED-EXHIB-ARM-BDLK
Fastframe™ middle full foot (4)	FF-MFF
Fastframe™ 90 degree connector kit	FF-90C
Fastframe™ ARCH KIT	FF-ACC
Fastframe™ two-way connector (4)	FF-2WC

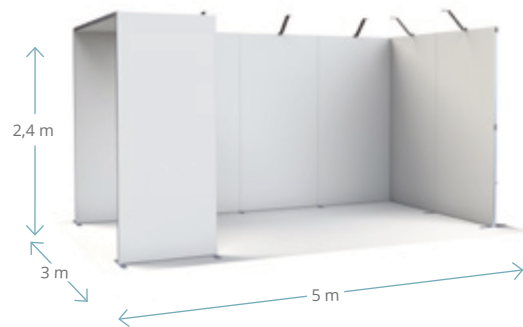

Portable carry bag



Feet can be added if required



Silicone edged (SEG) graphic

Graphics available in black back or polyester stretch, seamless graphics are available



FASTFRAME™ Counter: Coming Soon

Fastframe™ Stand 24m²



Quick and easy to assemble and disassemble. Add energy saving LED lighting to illuminate the back walls for more standout.

Material	Aluminium and ABS/nylon
Profile width	40mm
Profile colour	Silver
Assembly	Pre-assembled folding
Graphic area	Single or double-sided
Graphic attachment	SEG 3mm

Fastframe™ 1000x2400mm	FF-100X240
Fastframe™ 1000x2400mm (8) graphics	G-FF-100X240-BB/PS
Fastframe™ 1000x2000mm	FF-100X200
Fastframe™ 1000x2000mm (4) graphics	G-FF-100X200-BB/PS
Fastframe™ middle full foot (5)	FF-MFF
Fastframe™ pair side half feet (5)	FF-SHF
Fastframe™ Y-connector kit	FF-YC
Fastframe™ arch kit	FF-ACC
Fastframe™ two-way connector (5)	FF-2WC
Fastframe™ 90 degree connector kit	FF-90C

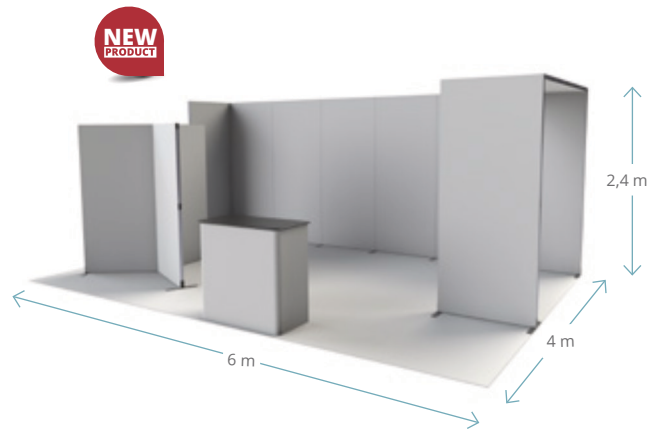

Portable carry bag



Feet can be added if required



Silicone edged (SEG) graphic

Graphics available in black back or polyester stretch, seamless graphics are available

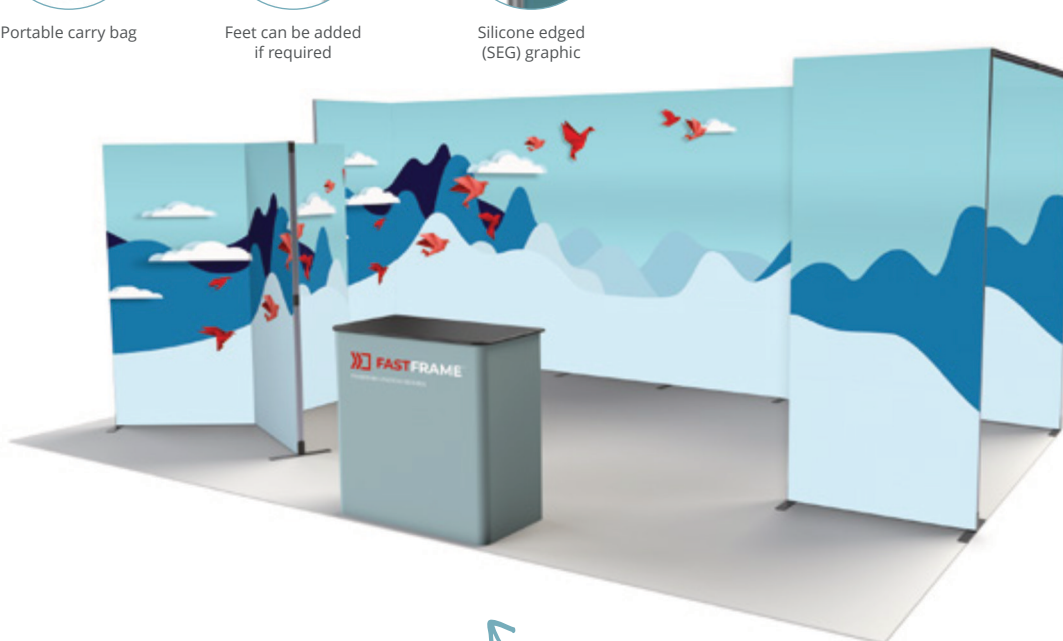

FASTFRAME™ Counter: Coming Soon



Arena Structures

Arena Gantry structures for your stand

These 25mm diameter aluminium tubes have been assembled and welded into sections of various sizes to form the basis of an imposing and solid architecture.

A wide range of sections are available to make this solution compatible with your project requirements. With 13 components in various lengths and designs, you can create the right structure for you, and your chosen mode of transport.

Simple, tool-free assembly

Simple assembly - sections are connected using the supplied bolt and wing-nut fixings, and no tools are required. The double-sided graphics are attached to the gantry using a bungee cord. Create maximum brand visibility using sections up to 6m long without the need for reinforcement.

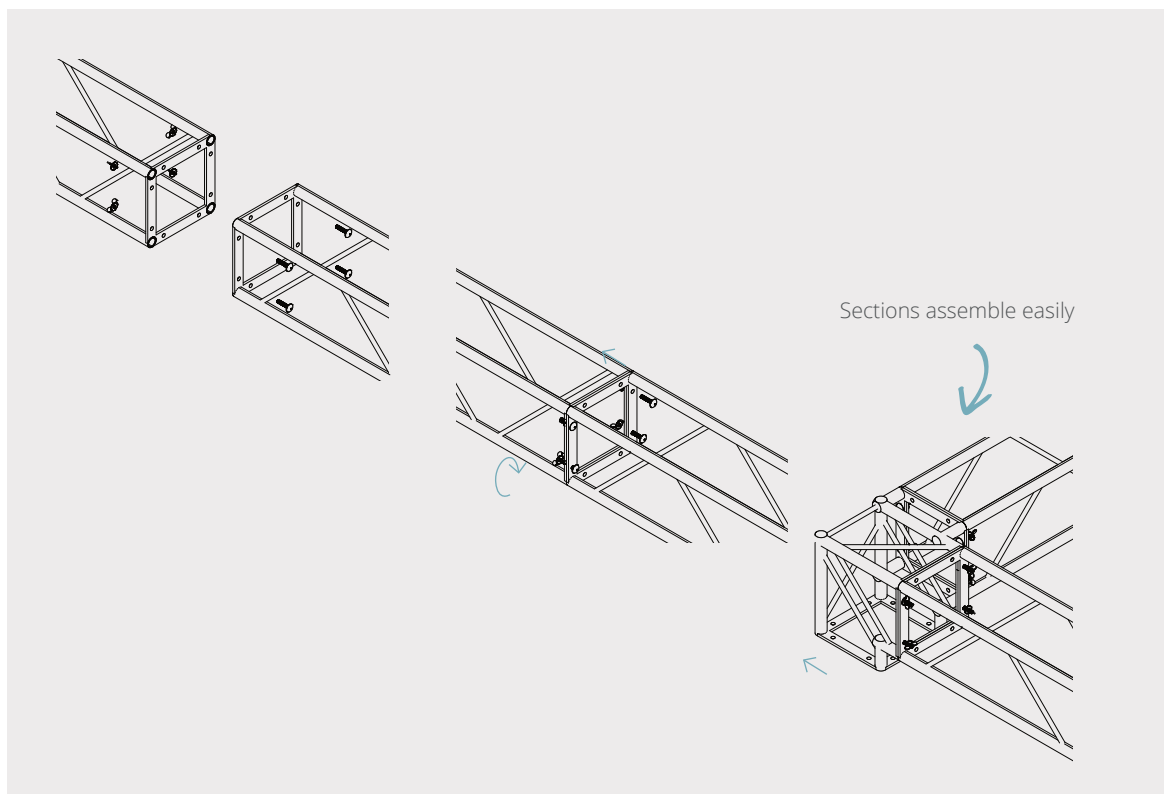

Arena components

Arena Straight Sections

The Arena Straight Sections are available in a variety of lengths, they are strong but lightweight with a natural silver grey finish. The system is quick and easy to assemble using bolt and wing-nut fixings. This aluminium tubular system is both modular and scalable, where different sections can be assembled and reused according to the needs of each project. The structure can then be dressed with interchangeable UV printed PVC graphics.

UT-S250	Section 250mm
UT-S500	Section 500mm
UT-S750	Section 750mm
UT-S1000	Section 1000mm
UT-S1250	Section 1250mm
UT-S1500	Section 1500mm
UT-S2000	Section 2000mm



Arena Junction Sections

The Arena Junction Sections are available in a variety of configurations including: 3-way T-junction, 4-way corner junction. The choice of sections enables a custom build design for your application to create a modular and scalable system. The structure can then be dressed with interchangeable UV printed PVC graphics.



90° angle 2 connections
UT-C21



Corner connection
3 connections UT-C30



T-junction 3 connections
UT-C35



T-junction 4 connections
UT-C40



4-way corner connector
UT-C41



Foot 250mm
UT-BS250

Arena Gantry stand designs

Arena Custom Stand 16m²

Material	Aluminium
Colour	Anodised
Graphic area	Single or double-sided
Graphic attachment	Bungee fixings
Graphic option	Vinyl



Arena Custom Stand 36m²

Material	Aluminium
Colour	Anodised
Graphic area	Single or double-sided
Graphic attachment	Bungee fixings
Graphic option	Vinyl



Arena Gantry free-standing design

Arena Custom Structure

Material	Aluminium
Colour	Anodised
Graphic area	Single or double-sided
Graphic attachment	Bungee fixings
Graphic option	Vinyl



Arena Hanging Structure



The Arena hanging structure is a tubular aluminium stage structure used as a light bridge or suspended sign with 6m sides to draw attention to your brand.

Material	Aluminium
Colour	Anodised
Graphic area	Single or double-sided
Graphic attachment	Bungee fixings
Graphic option	Vinyl



Hanging structures

Formulate suspended signs have been specially designed to allow for easy and safe installation. The lightweight aluminium tubular structure makes them ideal for use on exhibition stands, in shopping arcades or in high traffic areas.

Formulate Square Hanging Structure



Material	Aluminium tubes
Tube	Ø 30 mm
Assembly	Push-fit button
Shape	Square
Graphic area	Double-sided
Graphic attachment	Zipped tension fabric graphic
Application	Suspended pitons included, Slings not included
Availability	Basic range - in stock

Square Formulate 800	FORM-SQU-80	Ⓞ 1500(w) x 800(h) x 1500(d) mm
Square Formulate 1000	FORM-SQU-100	Ⓞ 3000(w) x 1000(h) x 3000(d) mm
Square Formulate 1500	FORM-SQU-150	Ⓞ 4500(w) x 1500(h) x 4500(d) mm



Formulate Circular Hanging Structure



Material	Aluminium tubes
Tube	Ø 30 mm
Assembly	Push-fit button
Shape	Circle
Graphic area	Double-sided
Graphic attachment	Zipped tension fabric graphic
Application	Suspended pitons included, Slings not included
Availability	Basic range - in stock

Circular Formulate 800	FORM-RNG-80	Ⓞ 1500(w) x 800(h) x 1500(d) mm
Circular Formulate 1000	FORM-RNG-100	Ⓞ 3000(w) x 1000(h) x 3000(d) mm
Circular Formulate 1500	FORM-RNG-150	Ⓞ 4500(w) x 1500(h) x 4500(d) mm



Formulate Rectangular Hanging Structure



Material	Aluminium tubes
Tube	Ø 30 mm
Assembly	Push-fit button
Shape	Rectangle
Graphic area	Double-sided
Graphic attachment	Zipped tension fabric graphic
Application	Suspended pitons included, Slings not included
Availability	Basic range - in stock

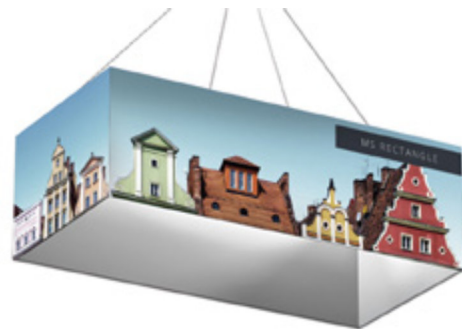

Formulate Rectangle 250	FORM-RTG-M100	Ⓞ 2500(w) x 1000(h) x 1200(d) mm
Formulate Rectangle 350	FORM-RTG-L100	Ⓞ 3500(w) x 1000(h) x 2500(d) mm
Formulate Rectangle 500	FORM-RTG-XL120	Ⓞ 5000(w) x 1200(h) x 2500(d) mm

MS Panel



Material	Aluminium tubes
Tube	Ø 30 mm
Assembly	Push-fit button
Shape	Rectangle
Graphic area	Double-sided
Graphic attachment	Zipped tension fabric graphic
Application	Suspended pitons included, Slings not included
Availability	Basic range - in stock



Formulate Panel 250	FORM-FLT-M100	Ⓞ 2500(w) x 1000(h) x 30(d) mm
Formulate Panel 350	FORM-FLT-L100	Ⓞ 3500(w) x 1000(h) x 30(d) mm
Formulate Panel 500	FORM-FLT-XL120	Ⓞ 5000(w) x 1200(h) x 30(d) mm



Display Backwalls

Display Backwalls create a dramatic backdrop to events, presentations, product demonstrations, pop-up shops or window displays. They are also ideal for smaller spaces, or as large static advertising boards in public spaces such as museums, reception areas, public transportation hubs and other large spaces.

Segmented frame walls are fully configurable, professional grade backwalls, where flexibility, ease of storage, reusing, portability and assembly are important. The pop-up display backwalls are constructed from lightweight aluminium scissor mechanisms that are easy to transport, assemble and store, and are ideal for small exhibitions or events as well as static displays. For a simple backdrop, the Pegasus tension walls offer a cost effective, easy solution to meet those needs. Configurable in both height and width, the tension wall is quick to assemble and makes an ideal backdrop to temporary or short-term presentations.

Display Backwalls

Backwalls can be configured in a variety of ways, based on the application, with each offering a different method of construction, illumination and use.



Pop-up backwalls

Impact Pop-up Straight



A great entry level display backwall that is perfect for use at an exhibition, event or for a demonstration backdrop. Frames are available in a variety of widths, and are quick and easy to deploy using the self-locating locking arms. Magnetic tape attaches to the back of the graphic panels enabling them to be attached directly to the mag bars which are mounted to the frames.

Material	Aluminium structure, plastic connectors
Assembly	Magnetic connectors
Shape	Straight
Graphic area	Single-sided (with or without D-ends) / double-sided (optional)
Graphic attachment	Mag bars, hangers and kickers
Application	Free-standing

3x2 Straight	IMP-3X2S	Ⓞ 1970(w) x 2225(h) x 306(d) mm
3x3 Straight	IMP-3X3S	Ⓞ 2700(w) x 2225(h) x 306(d) mm
3x4 Straight	IMP-3X4S	Ⓞ 3435(w) x 2225(h) x 306(d) mm



Magnetic bars



Magnetic Locking arms



Hook-over graphic attachment

Impact Pop-up Straight Bundle



Impact Pop-up straight bundles are a great entry level display backwall kit that contains everything you will need to get you up and running at a show, event or demonstration - they even come with a counter and lighting!

Material	Aluminium structure, plastic connectors
Assembly	Magnetic connectors
Shape	Straight
Graphic area	Single-sided (with or without D-ends) / double-sided (optional)
Graphic attachment	Mag bars, hangers and kickers
Application	Free-standing

3x2 Straight	99-XX-106	Ⓞ 1970(w) x 2225(h) x 306(d) mm
3x3 Straight	99-XX-107	Ⓞ 2700(w) x 2225(h) x 306(d) mm
3x4 Straight	99-XX-108	Ⓞ 3435(w) x 2225(h) x 306(d) mm



Impact Pop-up Bundle

Impact Pop-up Kit



Carry bag



Straight or curved frame system



Hangers, kickers and mag bars



1x Roll of self-adhesive magnetic tape (EM301)



Zenith transport and counter base case



Thermoformed table top in beech



2x PS950-1000-LED-BDLK lights

Impact Pop-up Curved



A great entry level display backwall that is perfect for use at an exhibition, event or for a demonstration backdrop. Frames are available in a variety of widths, and are quick and easy to deploy using the self-locating locking arms. Magnetic tape attaches to the back of the graphic panels enabling them to be attached directly to the mag bars which are mounted to the frames.

Material	Aluminium structure, plastic connectors
Assembly	Magnetic connectors
Shape	Curved
Graphic area	Single-sided (with or without D-ends) / double-sided (optional)
Graphic attachment	Mag bars, hangers and kickers
Application	Free-standing

3x2 Curved	IMP-3X2C	Ⓞ 1930(w) x 2225(h) x 485(d) mm
3x3 Curved	IMP-3X3C	Ⓞ 2540(w) x 2225(h) x 685(d) mm
3x4 Curved	IMP-3X4C	Ⓞ 3070(w) x 2225(h) x 960(d) mm



Magnetic bars



Magnetic Locking arms



Hook-over graphic attachment

Impact Pop-up Curved Bundle









Impact Pop-up curved bundles are a great entry level display backwall kit that contains everything you will need to get you up and running at a show, event or demonstration - they even come with a counter and lighting!

Material	Aluminium structure, plastic connectors
Assembly	Magnetic connectors
Shape	Curved
Graphic area	Single-sided (with or without D-ends) / double-sided (optional)
Graphic attachment	Mag bars, hangers and kickers
Application	Free-standing

3x2 Curved	99-XX-110	Ⓞ 1930(w) x 2225(h) x 485(d) mm
3x3 Curved	99-XX-071	Ⓞ 2540(w) x 2225(h) x 685(d) mm
3x4 Curved	99-XX-070	Ⓞ 3070(w) x 2225(h) x 960(d) mm



Impact Pop-up Bundle

<p>Impact Pop-up Kit</p>  <p>Carry bag</p>	 <p>Straight or curved frame system</p>	 <p>Hangers, kickers and mag bars</p>	 <p>1x Roll of self-adhesive magnetic tape (EM301)</p>	 <p>Zenith transport and counter base case</p>	 <p>Thermoformed table top in beech</p>	 <p>2x PS950-1000-LED-BDLK lights</p>
--	--	--	---	--	--	--

Quick+ Straight Kit



The premium Quick+ Straight display backwall is a full magnetic system that can be used single or double-sided. Use with optional interchangeable, vibrant UV printed PVC graphics. Deploys tool-free in seconds straight out of the supplied protective padded bag giving you a brilliant backwall display for your event or shell scheme. Quick+ displays are also available in a curved display and come in 3 different sizes.

Material	Aluminium structure, plastic connectors
Assembly	Magnetic connectors
Shape	Straight
Graphic area	Single-sided (with or without D-ends) / double-sided (optional)
Graphic attachment	Mag bars, hangers and kickers
Application	Free-standing

3x2 Straight	WH222-S-CA	Ⓞ 1970(w) x 2225(h) x 306(d) mm
3x3 Straight	WH223-S-CA	Ⓞ 2700(w) x 2225(h) x 306(d) mm
3x4 Straight	WH224-S-CA	Ⓞ 3435(w) x 2225(h) x 306(d) mm



Square end magnetic bars



Magnetic locking arms



Magnetic hanger

Quick+ Curved Kit



The premium Quick+ Curved display backwall is a full magnetic system that can be used single or double-sided. Use with optional interchangeable, vibrant UV printed PVC graphics. Deploys tool-free in seconds straight out of the supplied protective padded bag giving you a brilliant backwall display for your event or shell scheme. Quick+ displays are also available in a straight display and come in 3 different sizes.

Material	Aluminium structure, plastic connectors
Assembly	Magnetic connectors
Shape	Curved
Graphic area	Single-sided (with or without D-ends) / double-sided (optional)
Graphic attachment	Mag bars, hangers and kickers
Application	Free-standing

3x2 Curved	WH222-C-CA	Ⓞ 1930(w) x 2225(h) x 485(d) mm
3x3 Curved	WH223-C-CA	Ⓞ 2540(w) x 2225(h) x 685(d) mm
3x4 Curved	WH224-C-CA	Ⓞ 3070(w) x 2225(h) x 960(d) mm



Square end magnetic bars

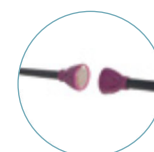

Magnetic locking arms



Magnetic hanger



Quick+ Straight Bundle



The Premium Quick+ Straight Display Bundle includes the full magnetic display backwall kit which can be used single or double-sided, the unique Zenith transit case which converts to a counter and two PS950-1000 LED lights. Use with optional interchangeable, vibrant UV printed PVC graphics. Deploys tool-free in seconds, giving you a brilliant backwall display for your event or shell scheme. Quick+ displays are also available in a curved display bundle and come in 3 different sizes.

Material	Aluminium structure, plastic connectors
Assembly	Magnetic connectors
Shape	Straight
Graphic area	Single-sided (with or without D-ends) / double-sided (optional)
Graphic attachment	Mag bars, hangers and kickers
Application	Free-standing

3x2 Straight	99-XX-101Q	Ⓜ 1970(w) x 2225(h) x 306(d) mm
3x3 Straight	99-XX-102Q	Ⓜ 2700(w) x 2225(h) x 306(d) mm
3x4 Straight	99-XX-103Q	Ⓜ 3435(w) x 2225(h) x 306(d) mm



Quick+ Bundle

Quick+ Kit



Padded nylon carry bag



Quick+ Structure Straight / Curved



Hangers, kickers and mag bars



1x Roll of self-adhesive magnetic tape (EM301)



Zenith transport and counter base case



Thermoformed table top in beech



2x PS950-1000-LED-BDLK lights

Quick+ Curved Bundle



The Premium Quick+ Curved Display Bundle includes the full magnetic display backwall kit which can be used single or double-sided, the unique Zenith transit case which converts to a counter and two PS950-1000 LED lights. Use with optional interchangeable, vibrant UV printed PVC graphics. Deploys tool-free in seconds, giving you a brilliant backwall display for your event or shell scheme. Quick+ displays are also available in a straight display bundle and come in 3 different sizes.

Material	Aluminium structure, plastic connectors
Assembly	Magnetic connectors
Shape	Curved
Graphic area	Single-sided (with or without D-ends) / double-sided (optional)
Graphic attachment	Mag bars, hangers and kickers
Application	Free-standing

3x2 Curved	99-XX-016Q	Ⓜ 1930(w) x 2225(h) x 485(d) mm
3x3 Curved	99-XX-017Q	Ⓜ 2540(w) x 2225(h) x 685(d) mm
3x4 Curved	99-XX-020Q	Ⓜ 3070(w) x 2225(h) x 960(d) mm



Quick+ Bundle

Quick+ Kit



Padded nylon carry bag



Quick+ Structure Straight / Curved



Hangers, kickers and mag bars



1x Roll of self-adhesive magnetic tape (EM301)



Zenith transport and counter base case



Thermoformed table top in beech



2x PS950-1000-LED-BDLK lights

Hop-up Impact Straight



Impact Hop-ups are simple lightweight interlocking frame structures that deploy in minutes. Complete with tension-fit graphics that can stay on even when packed away.

Graphic stays on structure once packed down

Material	Aluminium structure, plastic connectors
Assembly	Lock together with clips
Shape	Straight
Graphic area	Single-sided (with or without returns) or double-sided (optional)
Graphic attachment	Hook and loop
Application	Free-standing

3x2 quads	HUI3X2	Ⓞ 1525(w) x 2260(h) x 295(d) mm
3x3 quads	HUI3X3	Ⓞ 2260(w) x 2260(h) x 295(d) mm
3x4 quads	HUI3X4	Ⓞ 2995(w) x 2260(h) x 295(d) mm
3x5 quads	HUI3X5	Ⓞ 3730(w) x 2260(h) x 295(d) mm



Graphics attach with hook and loop fastener



Plastic connectors



Easy to transport



Carry bag

Ancillaries :

Stabilising feet (pair)	ES508	Ⓞ N/A
-------------------------	-------	-------

Hop-up Impact Curved



Impact Hop-ups are simple lightweight interlocking frame structures that deploy in minutes. Complete with tension-fit graphics that can stay on even when packed away.

Material	Aluminium structure, plastic connectors
Assembly	Lock together with clips
Shape	Curved
Graphic area	Single-sided (with or without returns)
Graphic attachment	Hook and loop
Application	Free-standing

3x3 quads	HOP-2-3X3-C	Ⓞ 2310(w) x 2270(h) x 570(d) mm
3x4 quads	HOP-2-3x4-C	Ⓞ 2950(w) x 2260(h) x 810(d) mm



Easy to transport



Plastic connectors

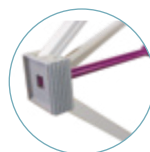

Graphics attach with hook and loop fastener

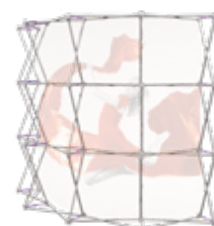

FASTFRAME™ Backwall Kit



Fastframe™ Backwall Kit	Price on demand	Ⓞ 2004(w) x 2007(h) x 400(d) mm
-------------------------	-----------------	---------------------------------

Fastframe™ Backwall Kit



Portable carry bag



2 frames
1000 x 2000mm
Includes feet



4 graphics
1000 x 2000mm,
2 graphics
2000 x 2000mm



FASTFRAME™ Pop-up Kit



Fastframe™ Pop-up Kit	Price on demand	Ⓞ 2690(w) x 2007(h) x 940(d) mm
-----------------------	-----------------	---------------------------------

Dimensions based on configuration shown

Fastframe™ Pop-up Kit



Portable carry bag



3 frames
1000 x 2000mm
includes feet



1 graphic
2000 x 3000mm,
3 graphics
1000 x 2000mm



2
45° connector
kit



Fabric tube walls

Formulate Straight



Formulate Straight backwalls are constructed of lightweight 30mm diameter push-fit aluminium tubing for tool-free simple deployment. Complete with optional double-sided dye-sublimated tension-fit fabric graphics that zip at the base to perfectly contour the shaped aluminium structure and maximize your brand message. Formulate displays offer a variety of great shapes with clean lines, ideal for creating picture backwalls or defining areas in rooms by screening or zoning.

Material	Aluminium tubing
Tube	Ø 30 mm
Assembly	Push-fit / Allen key
Shape	Straight
Graphic area	Double-sided
Graphic attachment	Zippered tension fabric graphic
Application	Free-standing with feet (included)



2000 mm	FORM-STR-20	Ⓞ 2000(w) x 2380(h) x 400(d) mm
2400 mm	FORM-STR-24	Ⓞ 2350(w) x 2380(h) x 400(d) mm
3000 mm	FORM-STR-30	Ⓞ 2950(w) x 2380(h) x 400(d) mm
4000 mm	FORM-STR-40	Ⓞ 3950(w) x 2380(h) x 400(d) mm
5000 mm	FORM-STR-50	Ⓞ 4950(w) x 2380(h) x 400(d) mm
6000 mm	FORM-STR-60	Ⓞ 5950(w) x 2380(h) x 400(d) mm



Bungee tubes



Numbered system for easy assembly



Gloves included

Formulate Horizontal Curve



Formulate Horizontal Curve displays are an eye-catching shape, constructed of lightweight 30mm diameter push-fit aluminium tubing, combined with a zippered tension-fit graphics for tool-free impressive backwalls. Formulate displays offer a variety of great shapes with clean lines, ideal for creating picture backwalls or defining areas in rooms by screening or zoning. The optional double-sided tension fabric graphics perfectly contour the shaped aluminium structures and maximise your brand message.

Material	Aluminium tubes
Tube	Ø 30 mm
Assembly	Push-fit button
Shape	Horizontal curve
Graphic area	Double-sided
Graphic attachment	Zippered tension fabric graphic
Application	Free-standing

2400 mm	FORM-CUR-24	Ⓞ 2350(w) x 2380(h) x 500(d) mm
3000 mm	FORM-CUR-30	Ⓞ 2950(w) x 2380(h) x 500(d) mm
6000 mm	FORM-CUR-60	Ⓞ 5910(w) x 2380(h) x 900(d) mm

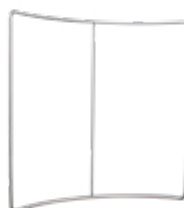

Zippered tension fabric graphic



Bungee tubes



Numbered system for easy assembly



Possibility to add LED Spotlights and Ancillaries

**NEW
PRODUCT**



Display Backwalls

Tension walls

Horizon



Horizon is the ideal solution for large scale promotions. Use single-sided or double-sided to maximise the impact for brand displays. Link individual units together to form a display wall. Securely weighted by twin water filled bases for total stability.

Material	Aluminium, moulded grey plastic base
Pole	Adjustable height (1500-2400 mm)
Graphic area	Single or double-sided
Graphic attachment	Eyelets
Base capacity	28 litres per tank
Wind resistance	Up to 12 mph / 19 km/h

Horizon	UB203	⊗ 2500(w) x 1500/3000(h) x 800(d) mm
---------	-------	--------------------------------------



Telescopic pole for adjustable height



Graphic attaches with eyelets

Pegasus



The large-format Pegasus tension banner has telescopic poles and can adjust to 2.5m wide and tall - perfect for large format imagery and brand messaging. Tool-free assembly for quick and simple deployment, Pegasus packs down into a supplied carry bag, and is suitable for vinyl or fabric graphics with pole pockets.

Material	Aluminium
Assembly	Telescopic poles / screws
Shape	Straight
Graphic area	Single or double-sided
Graphic attachment	Pole pocket
Application	Free-standing with feet (included)

Pegasus	UB165-S	⊗ 1429/2540(w) x 1000/2515(h) x 442(d) mm
---------	---------	---

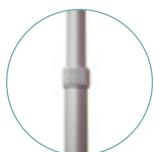

Telescopic poles



Poles slide into graphic pole pocket



Quick and easy installation



Pegasus 3m



The most compact 3m wide video wall! Ideal for large format photo calls for group meetings, political events or product launches.

Material	Aluminium
Assembly	Telescopic twist-lock poles
Shape	Straight
Graphic area	Single sided
Graphic attachment	Pole pocket
Application	Free-standing with feet (included)

Pegasus 3 m	UB167-S	Ⓞ 1845/3180(w) x 1835/2610(h) x 440(d) mm
-------------	---------	---



← from 1845 to 3180 mm →



Quick and easy installation

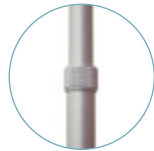

Telescopic poles



Display Banners

Portable display banners are ideal for a temporary but stable communications tool.

Our unique range of Display Banners are highly portable, quick to deploy and suitable for a broad range of applications. Choose from the economy range through to premium options for use indoors or select specifically designed solutions for outdoor applications.

Alternatively the fabric systems are a premium display solution, featuring aluminium tubing, with double-sided high-quality dye sublimated fabric graphics. Easy to deploy with tool-free assembly.

Display Banners

Affordable by nature, the roller banner range delivers a convenient, tool-free solution, with retractable graphics that deploy in seconds. Choose from a range of indoor or outdoor designs that best suits your application, with single or double-sided graphic options.

Tension banners are constructed of lightweight materials and offer the best value for money.



Tension textile systems

Formulate Monolith



Monolith; the gentle giant, with weighted base for high traffic areas and practical, changeable fabric graphics for multiple brand messaging. This tall double-sided display banner comes in a variety of widths, from 600mm up to 1500mm, and is trusted for stability and easy deployment.

Material	Aluminium tubes, steel base
Tube	Ø 30 mm
Assembly	Push-fit button, Allen key
Graphic area	Double-sided
Graphic attachment	Zipped tension fabric graphic
Application	Free-standing with metal base (included)
Transport	Padded with compartments

600 mm	FORM-MON-600	Ⓞ 600(w) x 2380(h) x 300(d) mm
900 mm	FORM-MON-900	Ⓞ 900(w) x 2380(h) x 300(d) mm
1200 mm	FORM-MON-1200	Ⓞ 1200(w) x 2380(h) x 300(d) mm
1500 mm	FORM-MON-1500	Ⓞ 1500(w) x 2380(h) x 300(d) mm



Hinged metal base (from sizes 900mm wide upward)



Bungee tubes

Formulate Monolith Eco



The Formulate Monolith Eco is an ideal alternative to a roller banner as it provides a cost effective option for the budget conscious whilst delivering an uninterrupted double-sided stretch fabric display. It comes with powder coated steel feet for increased stability that connect to the aluminium tubular frame. The tension graphic hugs the frame and is zipped at the base to hold it in place.

Material	Aluminium tubes, powder coated steel feet
Tube	25mm
Assembly	Push-fit, tool-free
Graphic area	Single or double-sided
Graphic attachment	Tension fabric graphic
Application	Free-standing with feet (included)
Transport	Simple carry bag

800 mm	FORM-MON-ECO-800	Ⓞ 800(w) x 2009(h) x 378(d) mm
1000 mm	FORM-MON-ECO-1000	Ⓞ 1000(w) x 2009(h) x 378(d) mm



Bungee tubes



Numbered system on tubes for easy assembly

Vector Media



Vector Media is a versatile display which accepts a variety of changeable media substrates; from SEG stretch fabric to rollable PVC. Each side of the frame has a channel for SEG fabrics, alternatively you can also use PVC with magnetic tape that magnetise to the inner frame profile.

Material	Aluminium
Profile width	35 mm
Profile Colour	Silver
Assembly	Tool-free
Graphic area	Single or double-sided
Graphic attachment	For textile graphics: 3 mm SEG For PVC graphics: magnetic tape (included)
Application	Free-standing solid foot

Vector Media	VF-MEDIA-16X06	600(w) x 1610(h) x 280(d) mm
--------------	----------------	------------------------------

PVC or fabric graphic, the choice is yours!

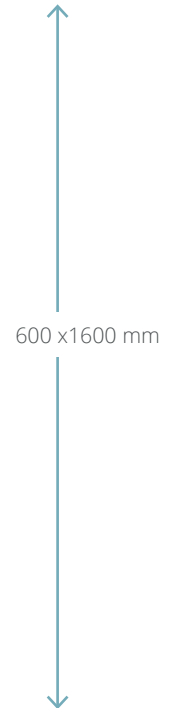

Fabric graphic with silicone edging (SEG)



PVC graphic with magnetic tape

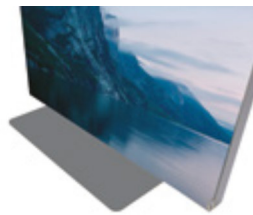

Tension banners (X Banner)

Beijing Lite



The Beijing Lite is a basic X-Banner with an ultra-light frame. It is very easy to assemble and compact once packed down.

Material	Fibreglass
Graphic area	Single-sided
Graphic attachment	Eyelets
Application	Free-standing
Transport	Budget drawstring carry bag

600 mm	WH358-6X16-01	Ⓞ 600(w) x 1800(h) x 650(d) mm
800 mm	WH358-8X18-01	Ⓞ 800(w) x 1800(h) x 650(d) mm



Banner reverse



Graphic attaches with eyelets

Blizzard



Blizzard is a great all-rounder as it is ideal for all kinds of corporate, sporting and outdoor events. Its simple design makes it very easy to assemble on-site, and because it's adjustable, it can accommodate different graphic sizes to suit your application.

Material	Plastic and metal
Pole	Adjustable in width and height
Graphic area	Single-sided
Graphic attachment	Eyelets
Base capacity	12 litres
Wind resistance	Up to 18 mph / 29 km/h
Transport	Non-padded bag

Blizzard	UB701	Ⓞ 600/800(w) x 1600/2100(h) x 540(d) mm
----------	-------	---



Non-padded bag included





Display Signs

Ultima Displays delivers a comprehensive range of professional display signage solutions for a variety of uses from navigational signs to advertising, information, decorative and display needs.

Display signage solutions are versatile, reusable, durable, and reliable, ensuring investment in hardware is maximised, whilst allowing the flexibility to update marketing messages frequently.

Display Signs

With a wide choice of installation options such as wall, suspended or free-standing, we are proud to offer one of the most comprehensive ranges on the market.

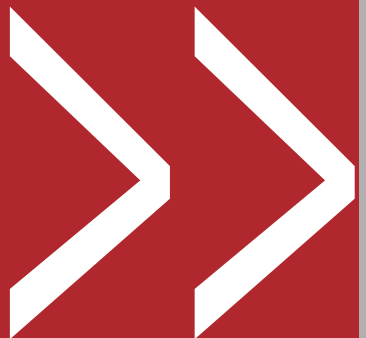

Free-standing signs

Wedge



Wedge is a weighted clamping banner base range that comes in 2 parts and is designed to hold a variety of rigid substrates for indoor or temporary outdoor usage. Available in four sizes from 300mm up to 1000mm, Wedge can be used in tandem with a second pair of bases to create larger displays.

Material	Powder coated steel
Graphic area	Single or double-sided
Graphic attachment	Screwed to base
Graphic option	Rigid panel from 18-40mm thickness - optional extra 1500mm height max.
Application	Free-standing

Wedge 300 mm	UB102-300-S	@ 300(w) x 85(h) x 360(d) mm
Wedge 600 mm	UB102-600-S	@ 600(w) x 85(h) x 360(d) mm
Wedge 800 mm	UB102-800-S	@ 800(w) x 85(h) x 360(d) mm
Wedge 1000 mm	UB102-1000-S	@ 1000(w) x 85(h) x 360(d) mm



Sentry



Sentry is a handy and versatile way of imparting brand messaging or wayfinding information quickly and tool-free using the 'snap action' poster area which can be deployed either landscape or portrait. A3 and A4 sizes are available and the weighted base aids deployment in high foot-fall areas.

Material	25mm aluminium profile, clear PVC protection sheet
Colour	Anodised silver finish, chromed corners
Mounting	Free-standing
Graphic attachment	Snap rail
Graphic option	Suitable for substrates up to 420 microns
Positioning	Portrait or Landscape

Sentry A4	SL104	@ 245(w) x 1005(h) x 326(d) mm
Sentry A3	SL103	@ 245(w) x 1075(h) x 326(d) mm



Snap frame

Symbol



Symbol is constructed of robust weighted steel and angled for optimal viewing and reading for better engagement with prospective customers. Interchangeable graphics slide in to the recess channel and fix in place tool-free with a turnscrew.



Material	Steel
Profile colour	Black
Assembly	Allen key and thumb screws
Graphic attachment	Thumbscrews
Graphic option	Rigid PVC and Dibond (3-5 mm thickness)
Weight	7.2 kg
Wind speed	18 mph

Symbol	IP01	420(w) x 1280(h) x 450(d) mm (A4) 480(w) x 1280(h) x 450(d) mm (A3)
--------	------	--



Content detail



Tool-free locking mechanism



Quick change graphic

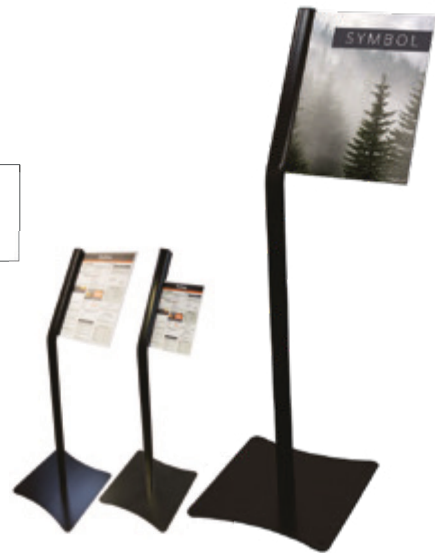

Whirlwind



The Whirlwind signage solution is a heavy duty, weather resistant swing sign with a wheeled base for ease of deployment. Base can be filled with a whopping 25 litres of water to keep in place. Double-sided graphics are held securely in a front loading 'snap-action' double-sided panel and it all flat packs for ease of transportation. A perfect piece of kit!



Material	Aluminium, steel, plastic base, PVC sheet cover
Graphic area	Double-sided
Graphic attachment	Snap rail
Graphic option	Banner vinyl
Application	Free-standing

Whirlwind - A1	UB207-A1	780(w) x 1165(h) x 500(d) mm
Whirlwind - A0	UB207-A0	1010(w) x 1554(h) x 625(d) mm



Tool-free snap rail



Wheels for easy transportation



A-sign Board



Pavement signage is a marketing stalwart. No high street would be without one, and the A-sign Board is one of the best. Simple to use with double-sided 'snap-action' front loading frames, complete with protective PVC sheeting to shield graphics which can be changed over and over again to keep up with brand messaging or offers.



Material	Aluminium, steel, PVC sheet cover
Graphic area	Double-sided
Graphic attachment	Snap rail
Wind speed	18 mph
Weight	10.56 kg

A-sign Board A1	VF204-C	638(w) x 1060(h) x 825(d) mm
-----------------	---------	------------------------------



Snap frame



Formulate Shadow



Formulate Shadow is a no fusses outdoor sign offering customers a viable alternative to traditional outdoor signs that typically rely on water or sand for stability.



Material	Steel
Assembly	Push-fit button/Allen key
Tube	32 mm
Graphic area	Double-sided
Graphic attachment	Zippered tension fabric graphic
Wind resistance	Up to 18 mph / 29 km/h
Weight	12.7 kg

Formulate Shadow	FORM-ODS	800(w) x 1174(h) x 420(d) mm
------------------	----------	------------------------------



Integrated castors



Base with handle



Monsoon



Monsoon is a perfect all-weather sturdy single or double-sided 'A' frame banner with bungeed PVC eyelet banner graphics - perfect for displaying brand messaging or wayfinding information.

Material	Aluminium tubes (25 mm), plastic connectors
Graphic area	Single or double-sided
Graphic attachment	Eyelets and looped bungee cords
Wind resistance	Up to 24 mph / 39 km/h



Monsoon 2500 mm	UB707-C	Ⓞ 2500(w) x 1000(h) x 640(d) mm
Monsoon 3000 mm	UB711-C	Ⓞ 3000(w) x 1250(h) x 795(d) mm



Eyeleted graphic attaches to frames with bungee cord



Metal hinge

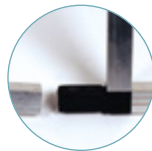

Interlocking sections



Stowaway



Make brand messaging or wayfinding information literally pop with the Stowaway pop-out display banner that deploys in seconds for use either indoors or secured outside with pegs supplied.

Material	Sprung steel pole
Graphic area	Double-sided
Graphic attachment	Elasticated pole pocket
Ground fixing	4 pegs (included)
Transport	Carry bag included
Wind Speed	18 mph (when pegged)



Stowaway 1400 mm	UB736-03A	Ⓞ 1420(w) x 700(h) x 400/480(d) mm
Stowaway 2000 mm	UB736-01A	Ⓞ 2020(w) x 1000(h) x 400/480(d) mm



Internal hook and loop straps



Portable carry bag

Formulate Round Table



The Formulate Round Table is a popular table shape for reception with a welded base for extra stability. Display your message at 360° angle with optional washable tension fabric graphic.

If you already have a display table and are looking for a custom printed tablecloth to promote your messaging, then contact us for a custom made quote. So whether you are looking for a large table cloth with hem, or smaller option with a slim silhouette, we can create a striking made to measure graphic to suit.

Material	Polypropylene
Assembly	Push-fit buttons
Graphic area	360°
Transport	Carry bag included

Formulate Round Table	FORM-TS-01A	Ⓞ 1000(h) x 600(dia) mm
-----------------------	-------------	-------------------------



Padded carry bag included



Simple assembly using numbered system

Custom printed tablecloth to promote your messaging



Wall mounted signs

Trappa Frame



The Trappa 'snap-action' Frame delivers a professional look and is quick to fix to a wall and easy to update. Posters can be changed, simply by opening the frame edges.

Material	25mm aluminium profile, clear PVC protection sheet
Colour	Anodised silver finish
Mounting	Wall*
Graphic attachment	Snap rail
Graphic option	Suitable for substrates up to 420 microns
Positioning	Portrait or Landscape

Trappa A4	AT401-C	Ⓞ 241(w) x 328(h) x 13(d) mm
Trappa A3	AT402-C	Ⓞ 328(w) x 451(h) x 13(d) mm
Trappa A1	AT404-C	Ⓞ 625(w) x 872(h) x 13(d) mm



Trappa snap frame

*: Wall mounting screws not included

Suspended signs

Twista Lite



Twista Lite delivers a smart, modern poster display system that is quick and simple to deploy via the 'snap-action' rail. Versatile, as well as functional, it can be displayed single-sided on walls or double-sided when suspended from ceilings.

Material	Aluminium (rail), plastic (end caps, hooks)
Colour	Grey
Mounting	Wall / Ceiling
Graphic area	Single or double-sided
Graphic attachment	Snap rail

500 mm Kit	TWLHR-500	Ⓢ 500(w) x 31(h) x 12(d) mm
600 mm Kit	TWLHR-600	Ⓢ 600(w) x 31(h) x 12(d) mm
800 mm Kit	TWLHR-800	Ⓢ 800(w) x 31(h) x 12(d) mm
850 mm Kit	TWLHR-850	Ⓢ 850(w) x 31(h) x 12(d) mm
1000 mm Kit	TWLHR-1000	Ⓢ 1000(w) x 31(h) x 12(d) mm
1500 mm Kit	TWLHR-1500	Ⓢ 1500(w) x 31(h) x 12(d) mm
Twista closed grey hook	TWLHR-CG	
Twista left grey moulding	TWLHR-LG	
Twista right grey moulding	TWLHR-RG	
3100 mm (rail only)	TWLHR-3100	Ⓢ 3100(w) x 31(h) x 12(d) mm

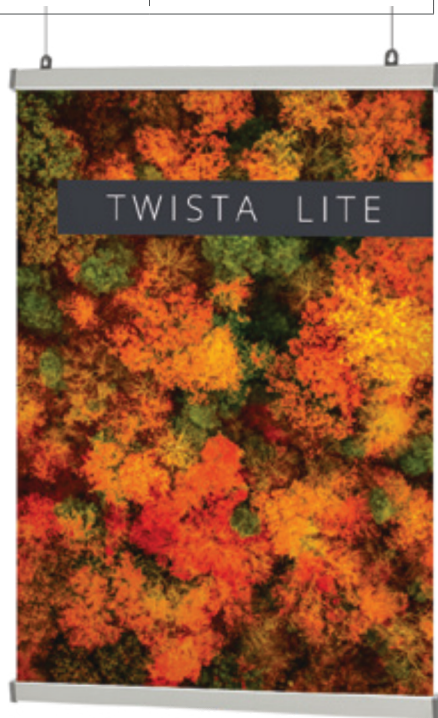

The snap rail clamps media securely



Top rail with hanging



Snap rail



Flag Banners

Draw attention to branding, products, services, or business premises with custom printed flags. Instantly noticeable due to their height, shape, and movement, our all-fibre flag poles are durable and flexible, easy to assemble and quick to deploy, making them an extremely effective means of advertising.

Choose from a range of free-standing, post / wall mounted, mobile and specialist hardware that can be used in a variety of applications such as car forecourts, festivals, and beach flags.

Alternatively, deploy taller or multiple flags to increase visibility and attention to branding. Our all-fibre flag poles are reusable with interchangeable graphics for greater return on investment. To protect this investment, it is recommended that flags be kept securely in place by selecting an appropriate base suitable for the desired application and location from the specifically designed range.

Flag Banners

Available as single or double-sided options and printed using hardy, UV resistant media, flag graphics can be utilised indoors or outside with standard or custom flag shapes.



Free-standing flags

Zoom+ Quill / Feather / Crest Flag



Zoom+ flags are a popular and versatile, lightweight flexible flag system, with black finish all fibre poles. Choose Feather, Quill or Crest shaped graphics. Ideal for advertising and used for all types of indoor and outdoor displays. Optional custom printed flag graphics are available in a range of sizes from small to extra-large and with a choice of single or double-sided options (small, medium, and large). The eye-catching shape creates movement in the wind and is a great for attracting attention.



Material	GRP fibre glass pole
Graphic area	Single-sided or double-sided (double-sided only available up to large)
Graphic attachment	Pole pocket
Wind resistance	Up to 63 mph / 101 km/h*

Zoom + Small	UF-ZM-SM	⊗ 550/800(w) x 2100/2600(h) mm
Zoom + Medium	UF-ZM-ME	⊗ 600/900(w) x 2800/3200(h) mm
Zoom + Large	UF-ZM-LA	⊗ 800/1100(w) x 3500/4000(h) mm
Zoom + Extra large	UF-ZM-EXLA	⊗ 850/1200(w) x 4600/4900(h) mm

* Under controlled test conditions



Ancillaries :

Bag (optional)	AB-ZML-01
----------------	-----------



Graphic attaches on to hook

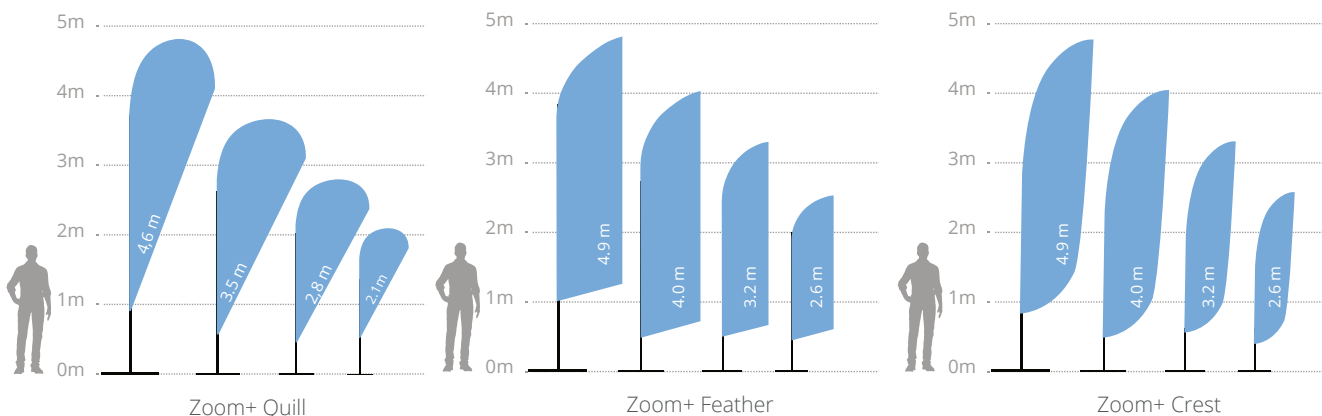

Zoom+ Edge Flag



Zoom+ is a popular and versatile, lightweight rectangular shaped flag system with black finish all-fibre poles. Ideal for all types of indoor and outdoor displays. Quick and easy to deploy and can withstand winds of approximately 13 -18m/h (21-29km/h). Optional custom printed flag graphic available in single and double-sided options (small, medium, and large), and all flag graphics have a printed pole pocket. The flag moves naturally in breezy/windy conditions and is ideal for attracting attention on car forecourts, at exhibitions and events, or outside a building or premises.

Material	Aluminium and GRP
Graphic area	Single-sided or double-sided (double-sided only available up to large)
Graphic attachment	Pole pocket
Wind resistance	Up to 18 mph / 29 km/h

Zoom + Edge Small	UF-ZME-SM	Ⓜ 750(w) x 2080(h) mm
Zoom + Edge Medium	UF-ZME-ME	Ⓜ 750(w) x 2900(h) mm
Zoom + Edge Large	UF-ZME-LA	Ⓜ 750(w) x 4000(h) mm
Zoom + Edge Extra large	UF-ZME-EXLA	Ⓜ 750(w) x 5000(h) mm

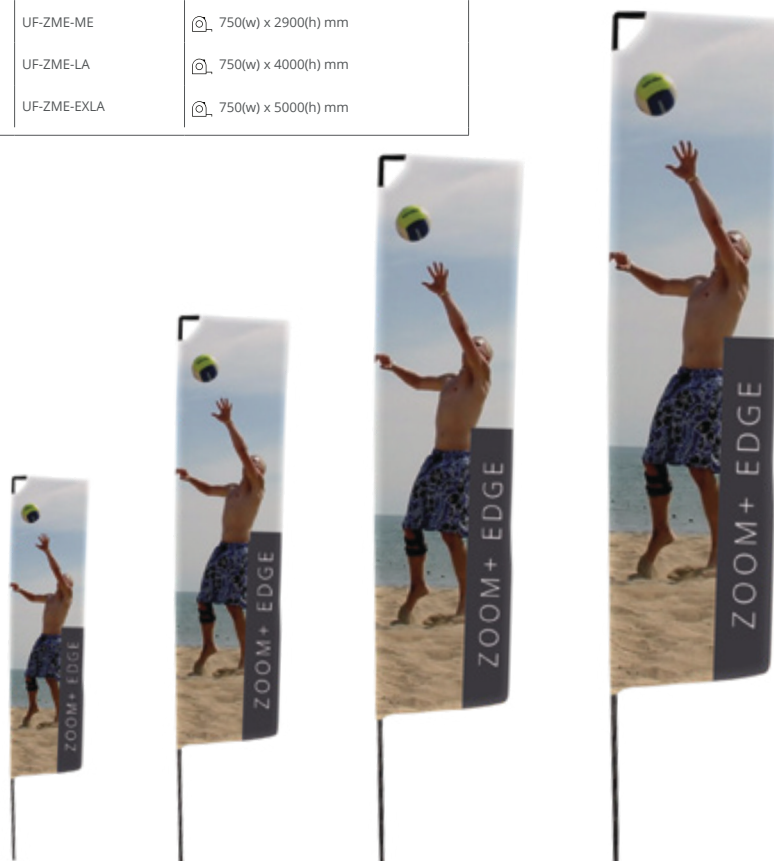

Graphic attaches on to hook

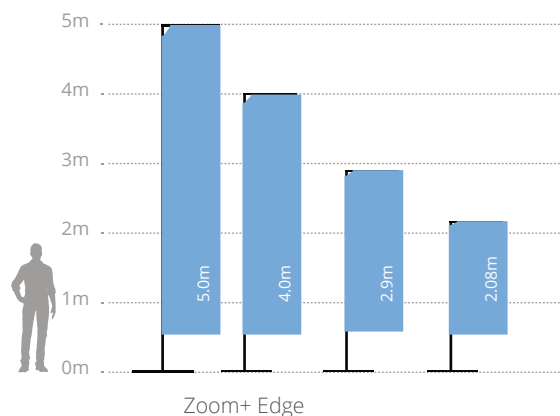

Free-standing flag bases

Weighted bases																			
Base	Product	Code				Utilisation		Zoom + Quill				Zoom + Feather				Zoom + Edge			
						Int.	Ext.	S	M	L	XL	S	M	L	XL	S	M	L	XL
	Large water base	UF-ZMLWB	50 x 50 x 26 cm	3.3 - 33 kg	30l	✓	✓	✓	✓	✓	✓	✓	✓	✓	✓	✓	✓	✓	✓
	Stackable water base	UF-ZMSWB	64.2 x 64.2 x 27.7 cm	3.6 - 30 kg	26l	✓	✓	✓	✓	✓	✓	✓	✓	✓	✓	✓	✓	✓	✓
	Parasol base	UF-ZMGMB	44 x 44 x 25 cm	1.2 - 23 kg	23l	✓	✓	✓	✓	✓	✓	✓	✓	✓	✓	✓	✓	✓	✓

Metal and cement bases																			
Base	Product	Code			Utilisation		Zoom + Quill				Zoom + Feather				Zoom + Edge				
					Int.	Ext.	S	M	L	XL	S	M	L	XL	S	M	L	XL	
	Zoom+ Small cross base	UF-ZMSCB-01	140 x 475 x 410 mm	1.05kg	✓	✓	*				✓	*				✓	*		
	Zoom + Large cross base	UF-ZMLCB-01	240 x 400 x 400 mm	1.5 kg	✓	✓	✓	✓	✓	✓	✓	✓	✓	✓	✓	✓	✓	✓	✓
	Zoom + Concrete base	UF-ZMCEM	Ø 450 x 350 mm	22.5 kg	✓	✓	✓				✓	✓	✓			✓	✓	✓	
	Zoom + Small square base 7,5 kg	UF-ZMLSQ-01	180 x 400 x 400 mm	7.5 kg	✓	✓	*	*			✓	✓				✓	✓		
	Zoom + Large square base 12.5kg	UF-ZMLSQ-03	180 x 450 x 450 mm	12.5kg	✓	✓	✓	✓	✓	✓	✓	✓	✓	✓	✓	✓	✓	✓	✓
	Zoom + Drive on car foot	UF-ZMCF5-01	605 x 195 x 125 mm	1.7 kg	✓	✓	✓	✓	✓	✓	✓	✓	✓	✓	✓	✓	✓	✓	✓

Spikes																			
Base	Product	Code			Utilisation		Zoom + Quill				Zoom + Feather				Zoom + Edge				
					Int.	Ext.	S	M	L	XL	S	M	L	XL	S	M	L	XL	
	Zoom + Ground spike	UF-ZMGS-01	600 mm	1.16kg		✓	✓	✓	✓	✓	✓	✓	✓	✓	✓	✓	✓	✓	✓
	Zoom + Budget ground spike	UF-ZMBGS-01	600 mm	1kg		✓	✓				✓	✓				✓	✓		



*Use with Weighting ring UB719-C



** Use with Heavy duty pegs FX620

Zoom+ Arch



The Zoom+ Arch stands out at any outdoor event or activity. With an overall height of 3m to the top of the graphic and a 4m width, it's perfect to use as a focal point or to attract attention. Simple and quick to assemble, it can be deployed in minutes and when used with the optional stackable bases, provides an extremely stable display that can be used in wind speeds of up to 20mph.

Material	GRP fibre glass pole - chrome steel end caps, plastic hook
Graphic area	Single-sided
Graphic attachment	Pole pocket
Wind resistance	Up to 19 km/h

Zoom+ Arch	ZOOM+ARCH	Ⓞ 4000(w) x 2500/3000(h) mm
Stackable base (optional) recommended that 2 bases either side are used	UF-ZMSWB	Ⓞ 642(w) x 277(h) x 642(d) mm



Supplied with 1 x 6-part bungee pole, 2 x base rods and hooks



Graphic attaches on to plastic hook



Water fillable base



Handle for easy transportation

Wind Dancer



An imposing telescopic flag which stands 5m high when fully assembled and is certain to make an impact at any outdoor event, Wind Dancer comes complete with a base which can be filled with either water or sand. The 3.5m flag height makes an impressive statement when the flagpole is deployed at its full 5m height, and is particularly impactful when used in large crowded areas because of its dominating presence.

Material	Aluminium pole, plastic base
Pole	Telescopic
Graphic area	Single-sided
Graphic attachment	Eyelets
Base capacity	66 litres
Wind resistance	Up to 18 mph / 29 km/h

Wind Dancer	WD105	Ⓞ 1000(w) x 2900/5300(h) x 1000(d) mm
-------------	-------	---------------------------------------

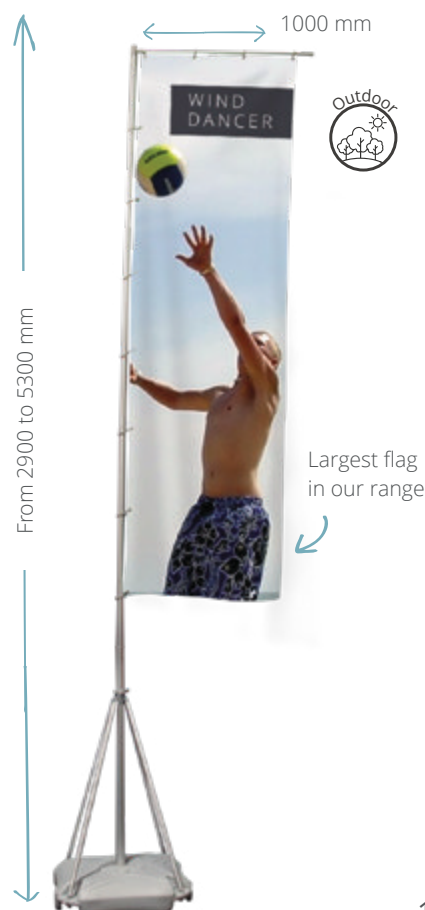

Post / wall mounted flags

Mistral

1 TEX PVC

The Mistral is a fixed outdoor flag system designed for mounting to lampposts or building exteriors and is perfect for advertising or promoting a brand or event. The mechanism attaches directly to a pole, posts, or wall and can be moved to accommodate varying graphic heights. An eye-catching solution that can also be used for information and wayfinding, this flag is especially effective when repeated over a series of posts.



Material	Aluminium castings and GRP tubes
Tube	Height adjustable
Graphic area	Single-sided or double-sided
Graphic attachment	Pole pocket
Wind resistance	Up to 40 km/h

Mistral	UB725-01	890(w) x 2000(h) mm
---------	----------	---------------------

Can be fixed to a pole or wall



Post fixing

Clamp
(Ø 300mm max)

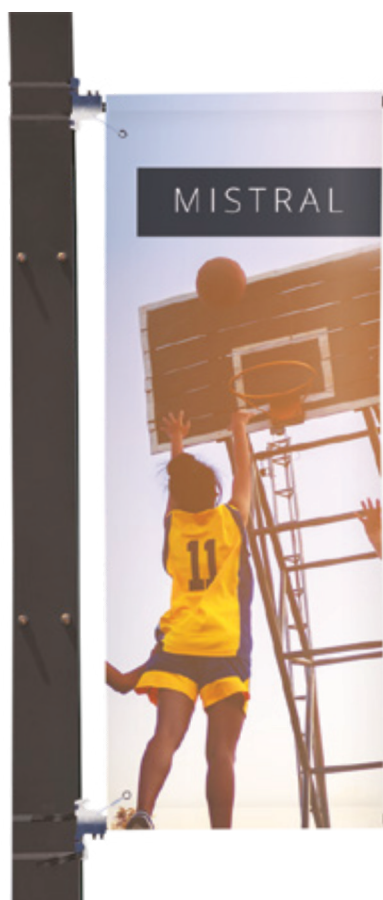

Mobile flags

Street Flag



Street flag is the ideal advertising medium when on the move or when you want to attract attention in a crowded space! Perfectly suited to promote events, highlight presence at trade shows or to organise a group of people on excursions! Rugged and lightweight, the backpack can be used with four different flag shapes and comes complete with fibre poles.

Material	Reinforced nylon backpack, fibre poles
Graphic area	Single-sided
Graphic attachment	Pole pocket
Graphic shapes	Feather - Quill - Edge

Street Flag	UF-ZMSTF-01	📏 310(w) x 540(h) x 80(d) mm
-------------	-------------	------------------------------

X-banner



One bag can be used with 4 flag shapes!

Feather



Quill



Edge



Zippered compartment to store graphics



Reinforced shoulder straps, adjustable strap and side mesh pocket



Storage for poles and rods



Tents

Take advantage of outdoor events with a temporary structure and create additional marketing opportunities. Offer customers protection and shelter from the weather by choosing custom-printed tents that also provide an attractive brand marketing solution.

Conventional pop-up tents and gazebos are fantastic provisional outdoor or indoor structures which provide a unique way to advertise in a vibrant impactful manner with fully printed canopies and walls.

Constructed from robust steel or aluminium in a variety of sizes that are easy to transport, assemble, deploy and pack away, pop-up tents are ideal for short term events, fairs and exhibitions.

Tents

For a more unique and unconventional structure, choose the Bora Inflatable Tent. Simple to inflate for rapid deployment with an appealing eye-catching shape, the Bora, like pop-up tents, also offers optional printed canopies and walls. Customisable areas make highly effective brand messaging, ensuring maximum impact at events. As with all custom-printed graphics, they can easily be replaced so that hardware is used multiple times, improving return on investment.

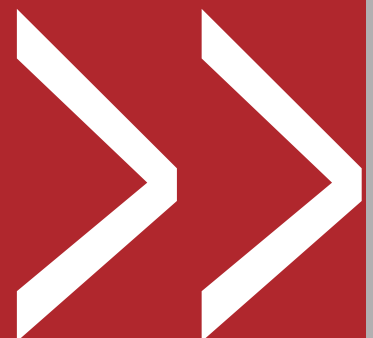

Pop-up tents

Zoom Tent Eco



The Zoom Tent Eco is the most cost-effective gazebo in our range. Quick and easy to deploy, the 3x3m tent can easily accommodate a 2.4m wide table making it a great solution for street markets, golf days or sporting events. Made from steel with a white powder coated finish, the frame easily shelters up to five people and folds completely into a portable wheeled carry bag. Custom fully printed canopy and walling is an optional extra.



Material	Steel frame, plastic joins
Graphic area	Double-sided (wall) / single-sided (canopy)
Graphic attachment	Hook and loop
Ground fixing	Pegs and ropes (included)
Wind resistance	Up to 18 mph / 29 km/h
Transport	Wheeled standard

Zoom Tent Eco 3x3	FD33-SQF	Ⓜ 3310(w) x 3315/3510(h) x 3310(d) mm
Canopy	FD33-CTW	Colour : White
Wall	FD33-FWW	Colour : White



Locking post



Winder for opening and closing



Zoom Tent



Ensure your event's a success come rain or shine by using an easy to deploy vibrant lightweight aluminium pop-up tent frame system. The Zoom Tent folds out and returns in minutes with tool-free deployment. Dress with a custom full printed canopy, full and half walls. Available in a range of sizes.



Material	Aluminium frame, plastic joints
Graphic area	Double-sided (wall, half wall) / single-sided (canopy)
Graphic colours	White - Black (standard) / Full Graphic (optional)
Graphic attachment	Hook and loop / Pocket (half wall)
Ground fixing	Pegs and ropes (included)
Wind resistance	Up to 18 mph / 29 km/h
Transport	Wheeled Standard



3x3 frame	ZT33-XAF-01	Ⓞ 2920(w) x 3160(h) x 2920(d) mm
3x4.5 frame	ZT345-XAF-01	Ⓞ 4300(w) x 3160(h) x 2920(d) mm
3x6 frame	ZT36-XAF-01	Ⓞ 5800(w) x 3160(h) x 2920(d) mm

Canopy	ZTXX-CTW	Colours : White
Canopy	ZTXX-CTK	Colours : Black
Wall	ZTXX-FWW	Colours : White
Wall	ZTXX-FWK	Colours : Black
Half wall	ZTXX-HWW	Colours : White
Half wall	ZTXX-HWK	Colours : Black

Ancillaries :

7.5 kg Weight	ZT-BASE
Half wall bar 2-3 m	ZT33-MTB



Pop-up frame



Tent weight (optional)



Automatic locking



Crank to tighten the canopy





Inflatable tents

Bora Tent



The Bora Inflatable Tent is a sturdy and attractive option for outdoor displays. Create shade and shelter for a registration desk, refreshment area or meeting point that fully shows off a brand. As one of the largest products in the range, there is plenty of print area on the canopy and backwalls (optional extra) for brand messaging. The backwalls zip in, so can be changed for a different message from the canopy if you wish. The Bora Tent uses trapped air technology: silent and free-standing once inflated.



Material	TPU, Polyester inner coat
Graphic area	Single-sided
Graphic attachment	Zip system (standard) / hook and loop (full graphic)
Ground fixing	Pegs (optional)
Wind resistance	Up to 24 mph / 39 km/h (if pegged)
Transport	Standard (included)

Bora Tent	INFT3-2Z	Ⓞ 3200(w) x 2450(h) x 3200(d) mm
-----------	----------	----------------------------------



400W electric pump (optional) INFTA-PE4EU



Inflation valve



Carry bag included



Counters

Temporary counters add a professional touch to any exhibition, event or retail environment. They provide a useful area for display or presentation space, and the ability to add a graphic creates additional marketing opportunities as well as offering a convenient storage facility.

Our counters are available in a range of price points and shapes, depending on requirements. Add impact to a welcome desk or a reception area in a public space with an illuminated counter or choose an outdoor option to promote a product or service at an open-air event.

Counters

Counters are the perfect partner for a promotional display or event to complement a backdrop or add focus to an area and are the ideal companions for any marketing campaign.



Promotional counters

Pop-up Counta



The Pop-up Counta is convenient lightweight pop-up counter that offers a substantial area to welcome guests yet packs down for easy transportation in a reinforced D-shaped wheeled trolley case.

The counter comes with shelves for storage and a beech-coloured counter-top. Often used for exhibitions, in supermarkets as a demonstration unit and for events.

Material	Aluminium, plastic and MDF tabletop
Assembly	Self-locking magnetic
Collapsible	Yes
Counter top	Foldable - Beech colour
Shelves	4
Graphic attachment	Magnetic hangers, bars and tape (included). Suitable for 440 microns min. substrate (optional extra)
Transport	1 Wheeled trolley case

Pop-up 2x2	PUC22C-C	📏 1260(w) x 965(h) x 430(d) mm
------------	----------	--------------------------------



Structure



Magnetic fixing



Wheeled carry bag

Hop-up Counta



Hop-up Counta is a durable lightweight hop-up counter, quick and easy to assemble with a single wrap around fabric graphic which stays on when collapsed and packed away. The unit is fitted with a beech effect counter top and provides a perfect welcome for guests.

Material	Aluminium, plastic, MDF tabletop and polycarbonate shelf
Assembly	Plastic locking arms
Collapsible	Yes
Counter top	Beech
Shelves	1
Graphic attachment	Hook and loop
Transport	One wheeled carry bag

Hop-up	HU301-001-C	📏 1060(w) x 1020(h) x 360(d) mm
--------	-------------	---------------------------------

Counter folds up with the graphic



Counter components



Plastic locking arm



Carry bag included

Shelf included



Modulate™ Counter



Modulate™ Counter consists of an innovative aluminium tubular frame, counter top, and printed tension fabric graphic. Powerful magnets encased inside the frame enables two or more counters to connect using simple magnetic principles. The counter can be used on its own or combined to make a long reception or bar area. Modulate™ Counter can be deployed in minutes, thanks to the tool-less construction. The printed tension fabric graphic will either sit on or under the counter-top to suit the application.

PATENT PENDING **MODULATE™**

Material	Ø 30mm Aluminium tubes, MDF tabletop/shelf
Assembly	Push-fit button
Collapsible	Yes
Counter top	Black
Shelves	1 (Optional)
Graphic attachment	Zip system
Transport	One padded carry bag, internal flap



Modulate™ Counter	FORM-MOD-CNTR	⊗ 800(w) x 1015(h) x 600(d) mm
Shelf	FORM-MOD-CNTR-02	⊗ 770(w) x 9(h) x 571(d) mm

2 possible finishes (with or without visible shelf)



Tabletop is held in place by plastic moulding underneath



Optional shelf

Basic Curved Counter



With a Double-D shape counter-top, the Basic Curved Counter delivers a functional and stylish look which is perfect to use for a reception desk or meeting point. The Counter is made from a rollable Corex tambour wrap to create the curved shape which push-fits into the thermoformed counter-top and base. A graphic can also be applied to the curved base to promote a message or brand. There is an opening for storage at the rear of the unit.

Material	MDF tabletop/base, Corex wrap
Assembly	Push-fit - Tool-free
Collapsible	Yes
Counter top	Beech / black
Transport	2 carry bags - included

Basics Curved Counter beech/beech	PK922-BEBE	⊗ 910(w) x 925(h) x 480(d) mm
Basics Curved Counter black/beech	PK922-BLKBE	⊗ 910(w) x 925(h) x 480(d) mm
Basics Curved Counter black/white	PK922-BLKW	⊗ 910(w) x 925(h) x 480(d) mm

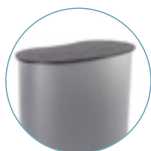

Interchangeable tabletops and bases

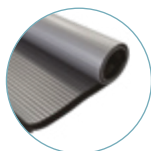

Grey counter wrap



Carry bag included



Counta



Counta is a lightweight portable indoor PVC demonstrator unit which includes a header panel, poles and shelf supporting poles. Printed graphics can be applied as vinyl directly onto the base wrap.

Available in white. Perfect for use in retail environments, one-off events and promotions.

Material	PVC
Assembly	Push-fit - Tool-free
Collapsible	Yes
Counter top	No
Shelves	1
Graphic attachment	Self-adhesive
Transport	Carry bag

Counta	PC607	<ul style="list-style-type: none"> 📏 Counter and front graphic - 805(w) x 2195(h) x 450(d) mm 📏 Front graphic - 680(w) x 280(h) x 20(d) mm
--------	-------	--

Carrying bag included



Shelf for storage



Promotional counter, ideal for a retail



illuminated Promotional Counters

Illumigo™ Counter



This versatile and quick to set-up double-sided counter lightbox is a great all-rounder not only at events but in retail environments from shopping centres to pop-up shops. Part of the Illumigo™ range, the Illumigo™ Counter is easy to assemble with a two-part counter top that secures using a pair of twist out top locators and locking screws. Building the unit is intuitive and tool-free as all the parts are numbered and simply slot together. Two optional graphics complete the look to create an impactful counter ideal for attracting attention in retail, event or exhibition environments.



Material	Aluminium 100 mm, MDF table top
Assembly	Tool-free
Collapsible	Yes
Counter top	White
Graphic attachment	Silicone Edged Graphics (3 mm silicone)
Transport	Protective box with carry handle
LED System	LED strips included



Illumigo™	ILLGO-COUNTER-EU	Ⓞ 1040(w x 1045(h)) x 420(d) mm
Illumigo™ Bag	ILLGO-BAG	Ⓞ 460(w) x 1160(h) x 190(d) mm



Optional Illumigo™ bag



Protective compartmented box



Pre-assembled LEDs in the frame



Steel side feet for stability





Barriers

Barrier systems improve queue management and help with crowd control.

For pedestrian control, café barriers can be used to make an attractive, professional and functional barrier, creating a temporary space that can be easily reconfigured to suit your needs.

Café barriers are easy to store, assemble, deploy and move to suit your requirements. They are available in economy and premium solutions, depending on your application and budget.

Barriers

Queue management systems can be used to control queues, providing structured and manageable lanes to help marshal customers and are also suitable for indoor or outdoor use.



Pedestrian control barriers

A cost-effective way of defining areas outside restaurants, bars, shopping centre and coffee shops, a complete Café Barrier system requires two posts and bases. To secure the graphic, there are two options; dependent on budget and where the system is being deployed.

If the Café Barrier is exposed to strong winds, we recommend a two-rail option ensuring the graphic is secured top and bottom to each post and base. If winds are not an issue but the budget is tight, then we suggest a single rail with two spring clips securing the bottom of the graphic.

Rails are available in 1m, 1.5m and 2m sizes, so it is quick and easy to calculate the number of café barriers required to define your space. To connect multiple barriers, add a choice of rails/spring clips plus one additional pole and base. For vibrant hardwearing graphics we can print on PVC.

Economy Café



Material	Aluminium
Graphic area	Double-sided / or single-sided
Graphic attachment	Looped top rail. Looped bottom rail or spring clips
Weight	9.13 kg



Graphic rail 1000 mm	UB214-1000	⌀ 1140(w) x 25(h) mm
Graphic rail 1500 mm	UB214-1500	⌀ 1940(w) x 25(h) mm
Graphic rail 2000 mm	UB214-2000	⌀ 2440(w) x 25(h) mm
Base	UB214B	⌀ 360 (Ø) mm
Post	UB214P	⌀ 960(h) mm
Spring clips (pair)	UB214-SC	



Spring clips for securing eyelet graphic



Graphic rail



Base and post

Deluxe Café



Material	Aluminium chrome look finish
Graphic area	Single / double-sided
Graphic attachment	Looped top rail. Looped bottom rail or spring clips
Weight	8.63 kg



Graphic rail 1000 mm	UB215-1000	⌀ 1140(w) mm
Graphic rail 1500 mm	UB215-1500	⌀ 1940(w) mm
Graphic rail 2000 mm	UB215-2000	⌀ 2440(w) mm
Base	UB215B	⌀ 360 (Ø) mm
Post	UB215P	⌀ 960(h) mm
Spring clips (pair)	UB215-SC	







Ancillaries

The range of ancillary products include literature holders, lighting solutions for various hardware ranges and transportation cases. These ancillaries offer flexibility and perfectly complement our product solutions.

Ancillaries

Enhance an exhibition stand by selecting various supporting products from our range of ancillaries that are often used to help promote your brand in a more impactful way, professionally display your latest literature, or add points of interest, making your stand more visible by using spot lights.



Literature holders (standard)

Zed-up Lite



Zed-up Lite are a popular range of aluminium literature stands that are stylish and highly portable. Quick and easy to deploy, Zed-up Lite is ideal for exhibitions and displays, folding down for easy transportation in a heavy duty hard case.

Material	Acrylic and anodised aluminium
Colour	Silver
Documents sizes	A4
Pockets	6
Double-sided	Yes
Transport	Hard case (included)

A4 (6 pockets)	AS315-002	Ⓜ 256(w) x 1460(h) x 370(d) mm
----------------	-----------	--------------------------------



Rigid carry case included



Lighting (standard)

Powerspot 950/1000 LED



Economical black LED spotlight particularly suitable for use with Pop-up stands.

Material	Aluminium and plastic
Positioning	270° - Straight arm
Watt output	12 watt (1400 Lumens/5500 Kelvins)
Watt consumption	12 Watt (1400 Lumens/5500 Kelvins)
Linked lights	2 max
Double kit includes	2 spotlights + 2.5m linking lead + 1 transformer
Power lead UK & Euro	Yes (cross head screwdriver needed)



Double kit	PS950-1000-LED-BDLK	Ⓞ, 103(w) x 425(h) x 29(d) mm
------------	---------------------	-------------------------------



Transformer included

Lighting (premium)

LED Floodlight



The LED Floodlight is the new stylish and economical way to illuminate a range of exhibition stands including Pop-ups, Formulate and a range of modular systems. Despite the compact design, this small LED light is still capable of producing 1200 Lumens but still only consuming a small amount of energy, making it far more efficient than the halogen equivalents. Link up to 5 lights together from one transformer, with handy linking cables.

Material	Aluminium and plastic
Watt output	80 watt
Watt consumption	12 watt (1200 Lumens/5631 Kelvin)
Linked lights	Link up to five to one transformer
Double kit includes	2 spotlights + 2.5m linking lead + 1 transformer
Power lead UK & Euro	Yes (cross head screwdriver needed)



Double kit	LED-FLOOD-ARM-BDLK	Ⓞ, 295(w) x 483(h) x 60(d) mm
------------	--------------------	-------------------------------



Transportation box



Transformer included

Connect up to 5 lights with one transformer

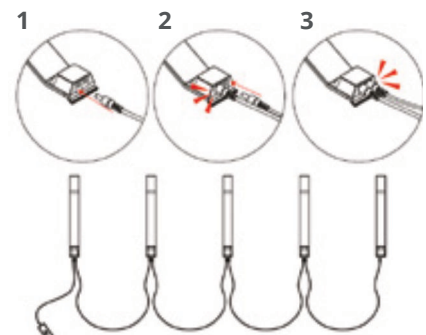

LED Strip Light



The LED Strip light is designed to work with a wide range of exhibition stands including, Pop-ups, Formulate and a range of modular stands. It has a unique wide head design feature, allowing for a wider spread of light, helping you illuminate more of your message. Link up to 5 lights together from one transformer, with handy linking cables.

Material	Aluminium and plastic
Watt output	80 watt
Watt consumption	12 watt (1200 Lumens/5631 Kelvin)
Linked lights	Link up to five to one transformer
Double kit includes	2 spotlights + 2.5m linking lead + 1 transformer
Power lead UK & Euro	Yes (cross head screwdriver needed)

Double kit	LED-STRIP-ARM-BDLK	100(w) x 520(h) x 35(d) mm
------------	--------------------	----------------------------



Transportation box



Transformer included

LED Exhibition Light



Specifically designed to work in conjunction with the Vector channel; this latest design requires no extra fitting, just plug in and switch on. Not only does the slick design make the LED Exhibition Light stand out from the crowd, the clever design cast out of aluminium allows any heat to dissipate over the entire body of the light, stopping any localised heat, which allows for long use with no overheating. Link up to 5 lights together from one transformer, with handy linking cables.

Material	Aluminium and plastic
Watt output	80 watt
Watt consumption	12 watt (1200 Lumens/5631 Kelvin)
Linked lights	Link up to five to one transformer
Double kit includes	2 spotlights + 2.5m linking lead + 1 transformer
Power lead UK & Euro	Yes (cross head screwdriver needed)

Double kit	LED-EXHIB-ARM-BDLK	50(w) x 455(h) x 55(d) mm
------------	--------------------	---------------------------



Transportation box



Transformer included

Lighting ancillaries

Recommended fixings for lighting

Integrated fixing					
	Universal fixing kit US901-C	Vector fitting VLF	LED fitting for Quick+ US902-C	30mm Ø Tube clamp US903	
Compatible with :					
 Spot LED Flood LED-FLOOD-ARM-BDLK	> Quick +	> Arena	> Vector	> Quick Impact > Quick + > Hop Up	> Formulate > Modulate™
 Spot LED Strip LED-STRIP-ARM-BDLK	> Quick +	> Arena	> Vector	> Quick Impact > Quick + > Hop Up	> Formulate > Modulate™
 Spot LED Exhibition LED-EXHIB-ARM-BDLK	> Linear > Vector	/	/	/	> Formulate > Modulate™
 Powerspot 950-1000 LED PS950-1000-LED-BDLK	> Quick Impact > Quick + > Hop-up	> Arena	> Vector	/	> Formulate > Modulate™

Convert your UK plug into EU version



Unscrew



Lift the lid



Pull the plug to extract it

Portable transportation cases

Zenith



Tough moulded polyethylene Zenith case offers a multitude of features. Versatile ultra-portable transport solution with maximum storage for pop-ups, backwalls, roller banners and extrusions, they also double up as counters with optional extra graphic wrap and table top. The standard case will house a 3x5 pop-up system and graphics. Secure Internal dividers protect graphics and the case can be locked using padlocks (not supplied).

Material	Medium-density polyethylene (MDPE) / Metal
Wheels	2
Handle	1
Accessories	Beech table top / graphic wrap

Zenith	AC600	Ⓞ (External dimensions) 600(w) x 956(h) x 400(d) mm
Tabletop (beech)	CO401-C	Ⓞ 15(h) x 640 (l) x 420 (p) mm



Zenith case thermoformed tabletop in beech



Foam protected lid holds two LED lights



Graphic wrap (optional)

Illumigo™ Bag



Wheeled bag for Illumigo™ 2x1, Retail, ONE or the Illumigo™ counter.

Material	Nylon and inner MDF
Colour	Black
Wheels	Yes
Handle	2

Illumigo™ bag	ILLGO-BAG	Ⓞ (Internal dimensions) 460(w) x 1160(h) x 190(d) mm
---------------	-----------	--



Wheeled bag



Inner compartment for graphic



Carry handle

Modular carrying bag



Ideal wheeled bag for transporting, protecting and storing exhibition stands, especially those made from standard modules (Vector & Formulate).

Material	Nylon
Colour	Black
Wheels	Yes
Handle	2

Modular Bag	AB-MODULAR-01	Ⓞ 340(w) x 1400(h) x 290(d) mm
-------------	---------------	--------------------------------



Carry handle



Wheels ø40mm





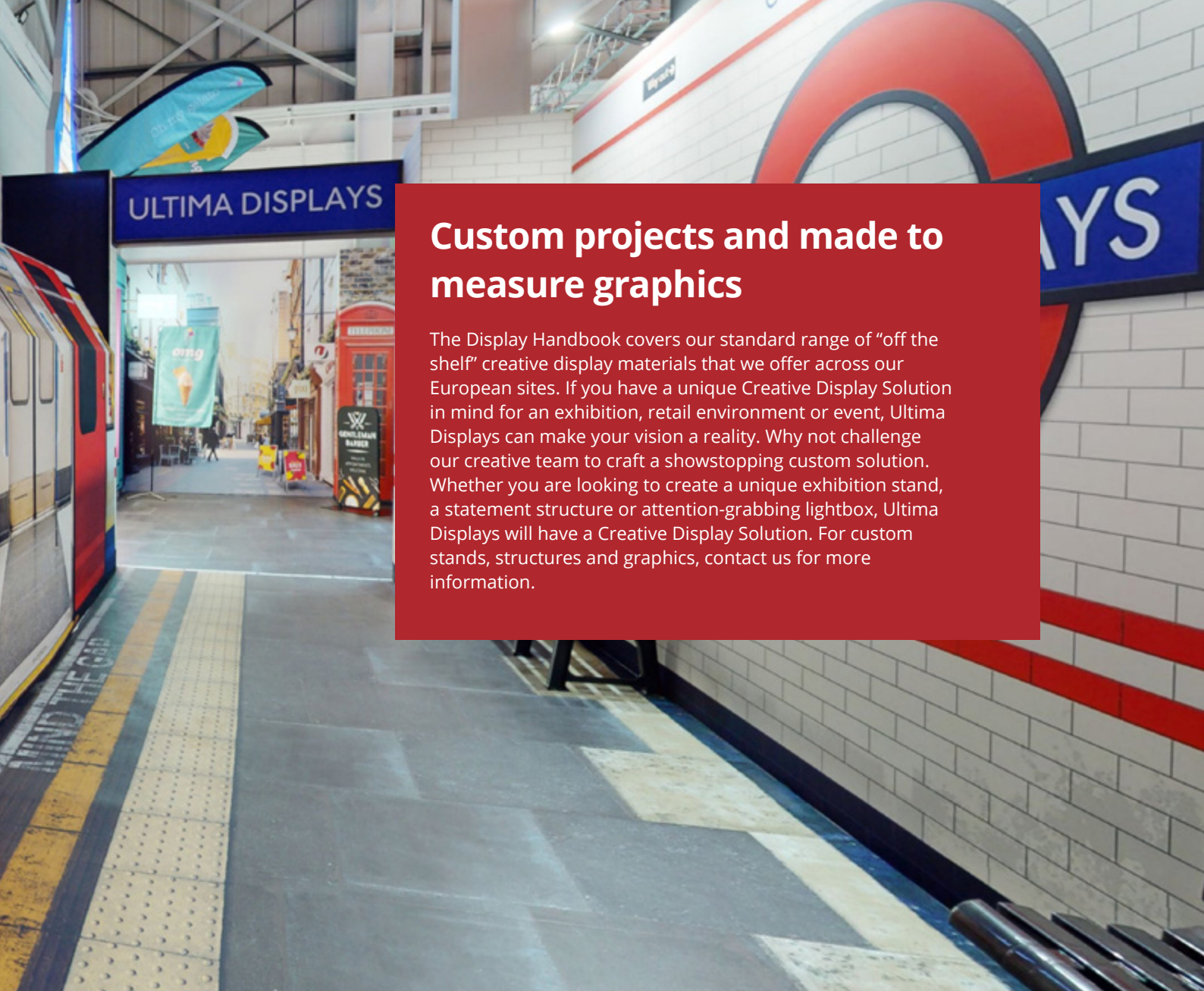

Custom projects and made to measure graphics

The Display Handbook covers our standard range of “off the shelf” creative display materials that we offer across our European sites. If you have a unique Creative Display Solution in mind for an exhibition, retail environment or event, Ultima Displays can make your vision a reality. Why not challenge our creative team to craft a showstopping custom solution. Whether you are looking to create a unique exhibition stand, a statement structure or attention-grabbing lightbox, Ultima Displays will have a Creative Display Solution. For custom stands, structures and graphics, contact us for more information.





Applications

At Ultima Displays we provide Creative Display Solutions that suit a multitude of industry applications.

Our display products are not only multi-functional and in many cases reconfigurable, but they can also be used for an array of different applications across a multitude of industries.

From retail or educational settings, outdoor sporting events to hospitality and corporate events; our Creative Display Solutions are suitable for more than just exhibitions.

The following pages are a guide for where our popular products are often used to enhance brand messaging in a vibrant and eyeing-catching way.



Retail

In the age of digitalisation, the main challenge for retail is to consider the customer experience at the point of sale.

Window displays



Commercial events



Retail signage



Pop-up store



Seasonal campaigns



Sales



Shop openings



Click and collect



Car showroom



Leisure Activities

The leisure industry represents an important part of the economy. From hospitality through to galleries, promoting the benefits of improved well-being and quality of life is essential with innovative displays that catch the eye.



Interior signage



Outdoor signage



Posters



Music venues



Hospitality signage



Suspended signage



Fairs and markets



Cinema foyers



Art galleries





Cultural Events

Social events with a national or international scope involve a large audience and can have a huge impact. Organisation is often extremely complex and requires significant communication resources.

Award ceremonies

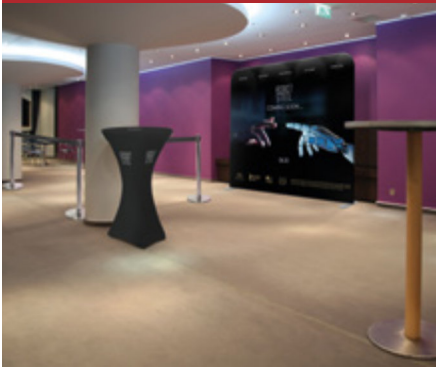

Award ceremonies



Professional sporting events



Amateur sporting events



Fundraising



Festivals



Military open days



Electoral campaigns



Fashion shoot



Corporate Events

Corporate events are essential for companies to maintain close relationships and partnerships with their customers, business partners or employees.



Product launches



Brand launches

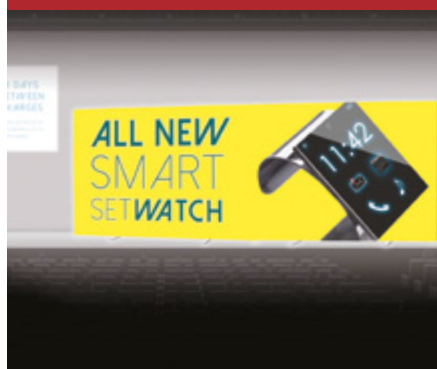

Sales meetings



Outdoor corporate events



Corporate meetings



Corporate dinners



Gala events



Open days



Showrooms





University Events

Educational, artistic and cultural events offer encounters, projects and practical experiments. The aim is to ensure artistic and cultural educational coherence for all pupils.

Open days



Campus life



Graduation ceremonies



Freshers week



Graduation shows



Career and job fairs



Ceremony staging



Student services



Gown hire



Conference

Preparing a conference is an excellent opportunity for brand exposure at high value-added events. Brand messaging should communicate exceptional, new, or informative and important information relating to your business.



Conferences



Seminars



Press conferences



Product launch



Concourse advertising



Roadshows



Networking



Trade show



Annual General Meetings (AGMs)





Exhibitions

From planning to execution: give your brand the exposure it deserves with original, renewable and customised solutions.

Exhibition reception area



Exhibition shell system



Merchandising stand



Exhibition literature stand



Art gallery exhibition



Reconfigurable exhibition



Virtual exhibition



Reconfigurable stand



Exhibition - suspended



Outdoor

Custom printed flags, signage, and tents invigorate any outdoor activity and attract attention to help brands or businesses stand out.



Car dealerships



Sporting meets and races



Festivals



Sales



Museums



Outdoor music events



Clubs



Inflatable





Shelter





Ellanze 

Ellanze 

Ellanze 

Ellanze 

Ellanze 

