

Preisliste
Price list

2022/2023



DIE VIELFALT | THE COLLECTIONS



EXAL



ELEVEN



CHARLESTON ROYAL



CHARLESTON SQUARE



EMPIRE ROYAL



TURN

DIE VIELFALT | THE COLLECTIONS



EMPIRE ROYAL CRYSTAL



VALENCIA



BELLEDOR



DELPHI



CRONOS



CRONOS CRYSTAL

DIE VIELFALT | THE COLLECTIONS



DELPHI DECO



FLORALE CRYSTAL



ACUBO



PLATEAU

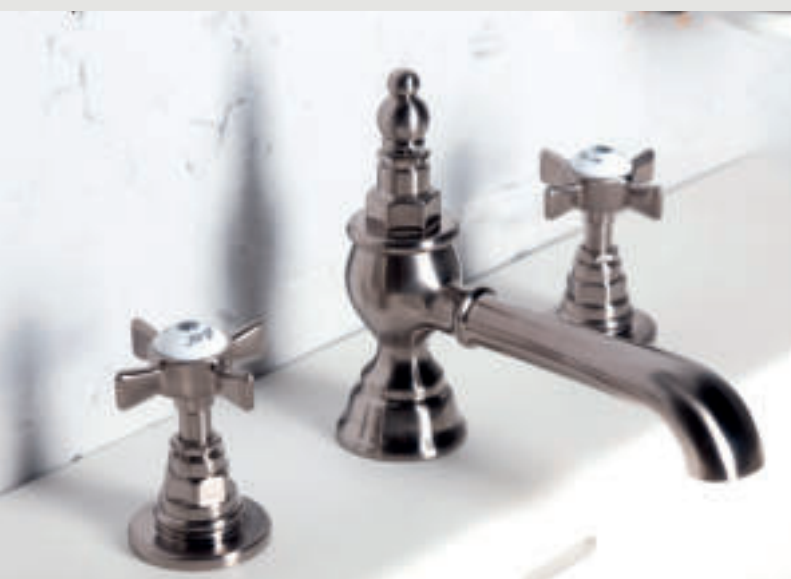

SERIE 1909



PALAZZO CRYSTAL

DIE VIELFALT | THE COLLECTIONS



APHRODITE



MUSCHEL



MINARETT



RAM SES/ALBANO



RAIN HEAVEN



SANITÄRKERAMIK/ SANITARY CERAMICS



Oliver Jörger – Geschäftsführer und Designer
Managing Director and Designer Oliver Jörger

Tradition und Innovationsfreude seit 1909

TRADITION AND THE JOY OF INNOVATION SINCE 1909

Vier Generationen prägen bis heute das deutsche Familienunternehmen Jörger, das mit seinem Namen international für erlesene Ästhetik im Bad steht. Seine weitreichende Geschichte repräsentiert das Wappen der Familie.

Das Fundament für die bestehende Tradition legte Bernhard Jörger: Am Hof von Großherzog Friedrich II. von Baden startete er als Blechnermeister die Bäder der adligen Familien aus und richtete im Mannheimer Schloss die Installationen ein. Mit dieser hohen Reputation gründete er im Jahr 1909 gemeinsam mit seinem Vater Albert das Unternehmen.

Gerhard E. Jörger setzte ab 1965 mit seinem Fachwissen als Ingenieur und seinem Gespür für Stil und Design neue Maßstäbe: Zukunftsweisend verband er höchste handwerkliche und technische Qualität mit besonderen, ästhetischen Ansprüchen. In dieser Tradition steht der Geschäftsführer Oliver Jörger und prägt bis heute als Designer den modernen Stil von Jörger.

There are four generations that to this day have charcaterised the family-owned company Jörger which has dedicated its name, internationally, to sophisticated, aesthetic bathrooms. Its far-reaching history is represented in the family coat of arms.

The foundation for the current tradition was laid by Bernhard Jörger: At the court of Friedrich II of Baden he was entrusted with the task of furnishing the exclusive bathrooms and was responsible for the installations in the palace of Mannheim. In 1909, with this high reputation, he founded the company with his father, Albert.

With his expertise as an engineer and instinct for style and design Gerhard E. Jörger set new standards from 1965: Future-oriented, he combined the highest level of craftsmanship and technical quality with special, aesthetic demands. The managing director Oliver Jörger follows this tradition and shapes the modern style of Jörger.

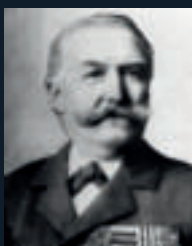

Albert Jörger sen.

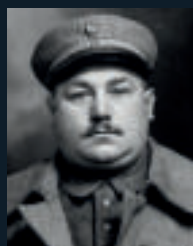

Bernhard Jörger



Albert Jörger jun.



Gerhard E. Jörger



Höchste Qualität für außergewöhnliche Ansprüche

HIGHEST QUALITY FOR EXCEPTIONAL DEMANDS



Edelste Materialien kommen in der Produktion aller Jörger-Armaturen und der im Design abgestimmten Accessoires zum Einsatz. Als Rohstoff dient ein hochwertiges, speziell legiertes Messing, das mit modernster Technik in eigener Manufaktur bearbeitet wird.

Die Kunst des präzisen Schleifens und Polierens ist der Garant für eine edle Optik. Mit größter Sorgfalt erfolgt die Bearbeitung der Oberflächen zumeist in reiner Handarbeit. Vom ersten bis zum letzten Arbeitsschritt legt die Design-Manufaktur Jörger kompromisslos Wert auf höchste Qualität. Made in Germany.

Qualitätsfaktor Nummer eins ist der Mensch. Unsere Mitarbeiter sind hoch qualifizierte Spezialisten, die sich der Verantwortung unseren anspruchsvollen Kunden gegenüber jederzeit bewusst sind. Ihre Leidenschaft und ihr handwerkliches Können spiegeln sich im gesamten Portfolio wider.

Only the finest materials are used in the production of Jörger taps and accessories, all in matching design. The raw material is a high quality, specially alloyed brass, which is worked on with the most sophisticated technology, in company own workshops.

The art of precise grinding and polishing is the guarantee for the elegant look. With the utmost care and attention, work on the surfaces is mostly done by hand. From the first step to the very last, the Jörger design manufactory is absolutely committed to delivering only the highest quality. Made in Germany.

However, the most important qualitative factor is, without doubt, the human being. Our employees are highly qualified specialists, who are fully aware of and appreciate the responsibility they bear towards the high expectations of our customers. Their passion and their craftsmanship skills are reflected in all Jörger products.



Als Designer entwickelt Oliver Jörger seit über 20 Jahren persönlich die zeitlose Formgebung weiter und prägt den modernen, geradlinigen Stil auf Basis der überlieferten Gestaltungsideale. Mit Armaturen wie EXAL, VALENCIA, TURN, EMPIRE ROYAL und CRONOS führt er mit kreativer Leidenschaft das einzigartige Jörger Design fort.

Ästhetische Inspirationsquellen sind für den studierten Ingenieur vor allem die Schönheit der Natur, außergewöhnliche Architektur und die Harmonie geometrischer Formen.

Jörger Design entwickelt sich ab und an auch im Dialog und Austausch mit Kunden und Partnern. So gibt es Designlösungen, die im Rahmen privater Projekte auf Kundenwunsch bzw. Designeranfrage entstehen. Jüngstes Beispiel ist ein Schmuckstück der VALENCIA-Kollektion: der schneeweiße Kristall als Pendant zum dekorativen schwarzen Kristall.

As designer, Oliver Jörger has been carrying the timeless design forward for over 20 years and has defined the modern, straight-lined style on the basis of traditional design ideals. He continues the unique Jörger design with creative passion, in fittings such as EXAL, VALENCIA, TURN, EMPIRE ROYAL and CRONOS.

The graduate engineer's aesthetic sources of inspiration include the beauty of nature, extraordinary architecture, and the harmony of geometrical shapes.

Sometimes it is also in exchanges with our customers and business partners that Jörger design develops. Thus there are design solutions created upon customer wish or design request within the scope of a private project. The most recent example for this is the snowy white crystal from the VALENCIA collection that forms the counterpart to the decorative black crystal.

„Jörger Design ist eine Aufgabe,
die mich glücklich macht.“

” JÖRGER DESIGN IS A TASK THAT GIVES ME JOY.”



JC

DESIGNSTILE – stilsicher zum Traumbad

DESIGN STYLES - TO THE DREAM BATHROOM WITH STYLE



MODERN & MINIMALISTISCH



LUXUS & AVANTGARDE

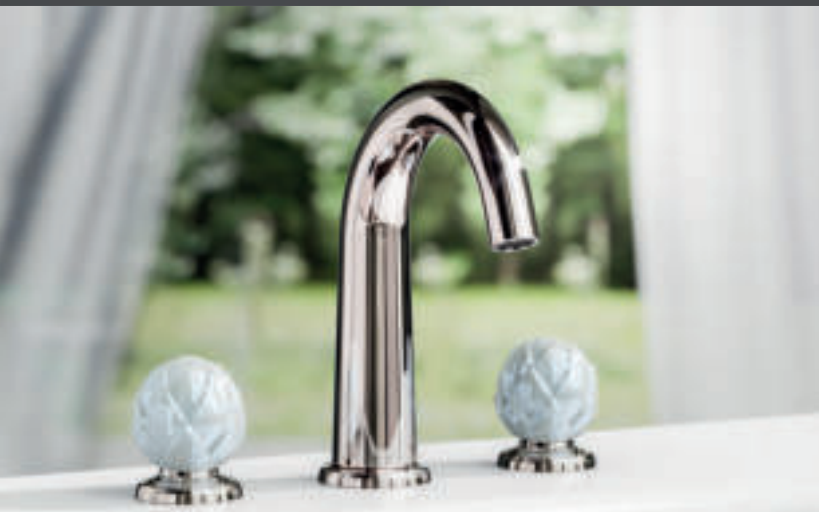

KLASSISCH & ELEGANT



ROMANTIK & NOSTALGIE

GESCHICHTE, PRODUKTION, DESIGNER / HISTORY, PRODUCTION , DESIGNER

- Das Erscheinen dieser Preisliste ersetzt alle vorherigen Preislisten. Sie ist gültig ab dem 1. Januar 2022.
- Nachdruck oder Vervielfältigung, gleichgültig nach welchem Verfahren, auch auszugsweise, ist nur mit unserer Genehmigung zulässig.
- Für alle Geschäftsbeziehungen legen wir unsere allgemeinen Verkaufs- und Lieferbedingungen als Vertragsbestandteil zugrunde.
- Diese Preisliste ist nicht zur Kenntnis des Endverbrauchers bestimmt. Sie weist Werte aus, die die Abrechnungsbasis darstellen.
- Die Mehrwertsteuer ist in den Basiswerten dieser Liste nicht enthalten. Sie wird dem Netto-Warenwert jeder Rechnung in Höhe des jeweils gültigen Satzes zugeschlagen und getrennt ausgewiesen.
- Abmessungen und Farben unterliegen den üblichen Toleranzen.
- Modelle und technische Details entsprechen bei Druck dem letzten Stand. Technische Konstruktions- und Modellveränderungen im Sinne des Fortschritts behalten wir uns vor. Druckfehler vorbehalten.
- This price list replaces all previous lists. Valid from January 1st, 2022.
- Reproduction or duplication of any part of this catalogue, in any manner, is authorised only with our permission.
- General sales and delivery terms are bound by contract.
- This catalogue is not for consumer use. The base prices listed are used to determine purchase price.
- Value added tax is not included in listed prices.
- Dimensions and colours are subject to usual allowance.
- Models and technical details shown are final. We reserve the right to technical improvements and/or changes.
- Subject to printing errors.

ARMATUREN & ACCESSOIRES / TAPS & ACCESSORIES

EXAL	3
ELEVEN	19
CHARLESTON ROYAL	35
CHARLESTON SQUARE	53
EMPIRE ROYAL	67
TURN	83
EMPIRE ROYAL CRYSTAL	95
VALENCIA	111
BELLEDOR	131
DELPHI	151
DELPHI DECO	173
CRONOS	183
CRONOS CRYSTAL	199
FLORALE CRYSTAL	213
REGENHIMMEL RAINHEAVEN	227
BRAUSEN SHOWER	
SERIENÜBERGREIFENDES UNIVERSALS	237
KÜCHENBATTERIEN KITCHEN TAPS	245

DESIGNKLASSIKER / DESIGN CLASSICS

ACUBO	267
PLATEAU	281
SERIE 1909	293
PALAZZO CRYSTAL	307
APHRODITE	319
MUSCHEL	331
RAMSES ALBANO	343
MINARETT	357

SANITÄRKERAMIK / SANITARY CERAMICS

DELPHI, SCALA II, SYMPHONIE II	249
BADEWANNE BATH TUB	263





Oberflächen | colours

Folgende Oberflächen sind bei dieser Serie möglich |
The following colours are possible with this collection

chrom	chrome	[.000] PG A
silbernickel	polished nickel	[.035] PG B
nerz	mink	[.095] PG C
nickel matt	satin nickel	[.036] PG C
edelmessing	sunshine	[.040] PG D
platin	platinum	[.065] PG D
edelmessing matt	sunshine matt	[.041] PG E
gold matt	gold matt	[.021] PG E
platin matt	platinum matt	[.066] PG E
nerz matt	mink matt	[.096] PG F
schwarz matt	black matt	[.092] PG G
weiß matt	white matt	[.052] PG G
bronze	bronze	[.011] PG H
gold	gold	[.020] PG I
roségold	rosegold	[.022] PG L
roségold matt	rosegold matt	[.023] PG L
himmelblau	azure	[.079] PG H
apfelgrün	apple-green	[.063] PG H
lila	purple	[.084] PG H
rosa	pink	[.081] PG H
türkis	turquoise	[.076] PG H
orange	orange	[.093] PG H
gelb	yellow	[.091] PG H
rot	red	[.082] PG H
relief schwarz	black-relief	[.087] PG H

Andere Oberflächen auf Anfrage |
Different colours on request

Waschtisch | Washbasin

ab Seite | from page 004

Bidet | Bidet

ab Seite | from page 005

Wanne | Bath tub

ab Seite | from page 005

Dusche | Shower

ab Seite | from page 007

Accessoires | Accessories

ab Seite | from page 014

Auf Anfrage können wir Produkte von
Drittanbietern auch gerne passend zu unseren
Oberflächen veredeln (vorbehaltlich der
Eignungsprüfung) | Third-party products may be
plated matching to our colours on request
(subject to valuation of suitability)

Maßzeichnungen unter www.joerger.de - Menü SERVICE.
 Technical specifications under www.joerger.de - menu SERVICE.

A chrom chrome	[.000]	E platin matt platinum matt	[.066]
B silbernickel polished nickel	[.035]	F nerz matt mink matt	[.096]
C nerz mink	[.095]	G schwarz-matt black matt	[.092]
C nickel matt satin nickel	[.036]	H farbig coloured	[.xxx]
D edelmessing sunshine	[.040]	H bronze bronze	[.011]
D platin platinum	[.065]	I gold gold	[.020]
E edelmess.matt sunshine matt	[.041]	L roségold rosegold	[.022]
E gold matt gold matt	[.021]	L roségold matt rosegold matt	[.023]

Waschtisch Batterien | Washbasin mixer

	632.10.333 Waschtisch 1-Hand Batterie <ul style="list-style-type: none"> ■ Ausladung 153 mm; Höhe 160 mm ■ Luftsprudler M24 x 1, verstellbar ■ Kartusche mit ker. Scheiben ■ Ablaufventil mit Klickverschluss 1 ¼" ■ 2 Druckschläuche M8x1 x ¾" x 450 mm 	Single lever washbasin mixer <ul style="list-style-type: none"> ■ spout projection 153 mm; height 160 mm ■ aerator M24 x 1, adjustable ■ cartridge with ceramic discs ■ push-open waste 1 ¼" ■ 2 pressure hoses M8x1 x ¾" x 450 mm 	A	B	C	D	E
			349,-	429,-	515,-	583,-	785,-
			F	G	H	I	L
			728,-	539,-	1.045,-	1.536,-	2.239,-

Variante | Alternative

	632.10.334 Waschtisch 1-Hand Batterie <ul style="list-style-type: none"> ■ <u>ohne</u> Ablaufventil 	Single lever washbasin mixer <ul style="list-style-type: none"> ■ <u>without</u> waste 	A	B	C	D	E
			329,-	399,-	486,-	550,-	740,-
			F	G	H	I	L
			689,-	510,-	909,-	1.158,-	1.796,-

	632.10.332 Waschtisch 1-Hand Batterie <ul style="list-style-type: none"> ■ mit Rohrverlängerung 80 mm ■ Ausladung 173 mm; Höhe 240 mm ■ Luftsprudler M24 x 1, verstellbar ■ 2 Druckschläuche M8x1 x ¾" x 600 mm ■ <u>ohne</u> Ablaufventil 	Single lever washbasin mixer <ul style="list-style-type: none"> ■ with body extension 80 mm ■ spout projection 173 mm; height 240 mm ■ aerator M24 x 1, adjustable ■ 2 pressure hoses M8x1 x ¾" x 600 mm ■ <u>without</u> waste 	A	B	C	D	E
			558,-	786,-	921,-	977,-	1.256,-
			F	G	H	I	L
			1.154,-	967,-	1.208,-	1.963,-	2.359,-

Waschtisch Batterie mit Exzenter-Ablaufgarnitur | Washbasin mixer with pop-up waste

	632.10.336 Waschtisch 1-Hand Batterie <ul style="list-style-type: none"> ■ Ausladung 153 mm; Höhe 160 mm ■ Kartusche mit ker. Scheiben ■ Luftsprudler M24 x 1, verstellbar ■ Exzenterstange ■ Exzenter-Ablaufgarnitur ■ 2 Druckschläuche M8x1 x ¾" x 450 mm 	Single lever washbasin mixer <ul style="list-style-type: none"> ■ spout projection 153 mm; height 160 mm ■ cartridge with ceramic discs ■ aerator M24 x 1, adjustable ■ lift rod ■ pop-up waste ■ 2 pressure hoses M8x1 x ¾" x 450 mm 	A	B	C	D	E
			379,-	466,-	559,-	633,-	849,-
			F	G	H	I	L
			716,-	586,-	1.036,-	1.668,-	2.298,-

Wand-Waschtisch 1-Hand Batterien | Single lever wall-washbasin mixer

	632.20.360 Wand-Waschtisch 1-Hand Batterie ½", Fertigmontageset <ul style="list-style-type: none"> ■ Ausladung 190 mm ■ Luftsprudler M24 x 1, verstellbar ■ Wandrosetten 	Single lever wall washbasin mixer ½", assembly set <ul style="list-style-type: none"> ■ projection 190 mm ■ aerator M24 x 1, adjustable ■ escutcheons 	A	B	C	D	E
			498,-	696,-	805,-	854,-	1.098,-
			F	G	H	I	L
			988,-	823,-	1.256,-	1.840,-	2.468,-

Benötigt | Required

	649.20.362 Wand-Waschtisch 1-Hand Batterie ½", Einbaukörper <ul style="list-style-type: none"> ■ Bedienhebel rechts ■ zu Fertigmontageset 632.20.360 ■ Kartusche mit ker. Scheiben 	Single lever wall washbasin mixer ½", concealed body <ul style="list-style-type: none"> ■ control lever on the right ■ for assembly set 632.20.360 ■ cartridge with ceramic discs 	A				
			258,-				

	649.20.364 Wand-Waschtisch 1-Hand Batterie ½", Einbaukörper <ul style="list-style-type: none"> ■ Bedienhebel links ■ zu Fertigmontageset 632.20.360 ■ Kartusche mit ker. Scheiben 	Single lever wall washbasin mixer ½", concealed body <ul style="list-style-type: none"> ■ control lever on the left ■ for assembly set 632.20.360 ■ cartridge with ceramic discs 	A				
			258,-				

A chrom chrome	[.000]	E platin matt platinum matt	[.066]
B silbernickel polished nickel	[.035]	F nerz matt milk matt	[.096]
C nerz milk	[.095]	G schwarz-matt black matt	[.092]
C nickel matt satin nickel	[.036]	H farbig coloured	[.xxx]
D edelmessing sunshine	[.040]	H bronze bronze	[.011]
D platin platinum	[.065]	I gold gold	[.020]
E edelmess.matt sunshine matt	[.041]	L roségold rosegold	[.022]
E gold matt gold matt	[.021]	L roségold matt rosegold matt	[.023]

Bidet Batterie | Bidet mixer

	632.10.111 Bidet 1-Hand Batterie ■ Ausladung 180 mm; Höhe 160 mm ■ Luftsprudler M18,5 x 1 mit Kugelgelenk ■ Kartusche mit ker. Scheiben ■ Ablaufventil mit Klickverschluß 1 ¼" ■ 2 Druckschläuche M8x1 x 3/8" x 450 mm	Single lever bidet mixer ■ spout projection 180 mm; height 160 mm ■ aerator M18,5 x 1 with ball joint ■ cartridge with ceramic discs ■ push-open waste 1 ¼" ■ 2 pressure hoses M8x1 x 3/8" x 450 mm	A	B	C	D	E	
			399,-	490,-	589,-	698,-	898,-	
			F	G	H	I	L	
				753,-	689,-	1.148,-	1.676,-	2.294,-

Zubehör für Waschtisch- und Bidet-Batterien | Supplies for washbasin and bidet mixer

	632.12.100 Eckventil ½" ■ Ausladung 105 mm ■ Fettkammer-Innenoberteil ½" ■ Quetschverschraubung ■ Schubrossette	Angle valve ½" ■ projection 105 mm ■ cartridge ½" ■ compression joint ■ escutcheon	A	B	C	D	E	
			99,-	122,-	163,-	173,-	223,-	
			F	G	H	I	L	
				197,-	184,-	365,-	465,-	610,-

	649.15.340 Waschtisch-Tassensiphon 1 ¼" ■ schwere Ausführung ■ Rosette ■ Abgangsrohr ø 32 mm ■ Tauchrohrlänge 165 mm	Washbasin cupped siphon trap 1 ¼" ■ heavy brass ■ escutcheon ■ outlet tube ø 32 mm ■ dip pipe 165 mm	A	B	C	D	E	
			195,-	296,-	368,-	429,-	568,-	
			F	G	H	I	L	
				498,-	378,-	539,-	686,-	832,-

	649.15.270 Zwangsablaufventil ■ Schaftlänge 70 mm ■ für Waschbecken ohne Überlauf	Restraint drain/waste ■ length of shaft 70 mm ■ for washbasins without overflow	A	B	C	D	E	
			68,-	129,-	185,-	239,-	312,-	
			F	G	H	I	L	
				299,-	176,-	394,-	429,-	582,-

	649.15.271 Zwangsablaufventil ■ Schaftlänge 100 mm ■ für Waschbecken ohne Überlauf	Restraint drain/waste ■ length of shaft 100 mm ■ for washbasins without overflow	A	B	C	D	E	
			72,-	138,-	196,-	254,-	329,-	
			F	G	H	I	L	
				318,-	186,-	418,-	454,-	616,-

Badewanne, Aufputz-Batterien | Bath tub mixer sets, exposed

	632.20.500 Wannenfüll- und Brausebatterie für Aufputzmontage, mit Garnitur ■ Ausladung 194 mm ■ Kartusche mit ker. Scheiben ■ manuelle Umstellung Wanne/Brause ■ verdeckte S-Anschlüsse ½" x ¾" ■ Handbrause mit 3 Strahlarten, Anti-Kalk-System und Rückflussverhinderer ■ Metall-Brauseschlauch 1500 mm, beidseitig mit drehbarem Konus	Exposed tub/shower mixer ½", incl. shower set ■ spout projection 194 mm ■ cartridge with ceramic discs ■ manual tub/shower diverter ■ concealed S-connections ½" x ¾" ■ hand shower with 3 jets, anticalc. system and backflow preventer ■ metal shower hose 1500 mm, both sides with turning cone	A	B	C	D	E	
			569,-	1.099,-	1.554,-	1.796,-	2.525,-	
			F	G	H	I	L	
				2.196,-	1.129,-	2.185,-	2.925,-	3.189,-

Achtung! Dieser Artikel kann nicht in farbig geliefert werden.
Attention! This item can not be delivered in coloured.

	632.20.505 Wannenfüll- und Brausebatterie für Aufputzmontage, mit Garnitur ■ Ausladung 194 mm ■ Kartusche mit ker. Scheiben ■ manuelle Umstellung Wanne/Brause ■ verdeckte S-Anschlüsse ½" x ¾" ■ Handbrause aus Metall mit einer Strahlart, Anti-Kalk-System und Rückflussverhinderer ■ Metall-Brauseschlauch 1500 mm, beidseitig mit drehbarem Konus	Exposed tub/shower mixer ½", incl. shower set ■ spout projection 194 mm ■ cartridge with ceramic discs ■ manual tub/shower diverter ■ concealed S-connections ½" x ¾" ■ metal hand shower with 1 jet, anticalc. system and backflow preventer ■ metal shower hose 1500 mm, both sides with turning cone	A	B	C	D	E	
			699,-	1.329,-	1.646,-	1.866,-	2.595,-	
			F	G	H	I	L	
				2.266,-	1.236,-	2.279,-	2.995,-	3.159,-

Maßzeichnungen unter www.joerger.de - Menü SERVICE.
 Technical specifications under www.joerger.de - menu SERVICE.

A chrom chrome	[.000]	E platin matt platinum matt	[.066]
B silbernickel polished nickel	[.035]	F nerz matt mink matt	[.096]
C nerz mink	[.095]	G schwarz-matt black matt	[.092]
C nickel matt satin nickel	[.036]	H farbig coloured	[.xxx]
D edelmessing sunshine	[.040]	H bronze bronze	[.011]
D platin platinum	[.065]	I gold gold	[.020]
E edelmess.matt sunshine matt	[.041]	L roségold rosegold	[.022]
E gold matt gold matt	[.021]	L roségold matt rosegold matt	[.023]

	632.20.510 Wannenfüll- und Brausebatterie für Aufputzmontage, ohne Garnitur <ul style="list-style-type: none"> ■ Ausladung 194 mm ■ Kartusche mit ker. Scheiben ■ manuelle Umstellung Wanne/Brause ■ verdeckte S-Anschlüsse 1/2" x 3/4" 	Exposed tub/shower mixer 1/2", incl. shower set <ul style="list-style-type: none"> ■ spout projection 194 mm ■ cartridge with ceramic discs ■ manual tub/shower diverter ■ concealed S-connections 1/2" x 3/4" 	A	B	C	D	E
			495,-	956,-	1.264,-	1.475,-	2.197,-
			F	G	H	I	L
			1.910,-	982,-	1.938,-	2.458,-	2.686,-

	632.20.540 Wannenfüll- und Brausebatterie für Standrohrmontage, mit Garnitur <ul style="list-style-type: none"> ■ Ausladung mit Standrohren 231 mm ■ Kartusche mit ker. Scheiben ■ manuelle Umstellung Wanne/Brause ■ Handbrause mit 3 Strahlarten, Anti-Kalk-System und Rückflussverhinderer ■ Metall-Brauseschlauch 1500 mm, beidseitig mit drehbarem Konus 	Tub/shower mixer for supply pipes, incl. shower set <ul style="list-style-type: none"> ■ spout projection with pipes 231 mm ■ cartridge with ceramic discs ■ manual tub/shower diverter ■ hand shower with 3 jets, anticalc. system and backflow preventer ■ metal shower hose 1500 mm, both sides with turning cone 	A	B	C	D	E
			549,-	1.069,-	1.476,-	1.739,-	2.415,-
			F	G	H	I	L
			2.139,-	1.069,-	2.129,-	2.716,-	2.929,-

Achtung! Dieser Artikel kann nicht in farbig geliefert werden.
Attention! This item can not be delivered in coloured.

Benötigt | Required

	632.15.260 Wasserzufuhrstandrohre 1/2" <ul style="list-style-type: none"> ■ 2 Stück, in Boden einzuschrauben ■ inkl. Winkelstück zum Anschluß der Wannenfüll- und Brausebatterie ■ Höhe 775 - 800 mm 	Water supply pipes 1/2" <ul style="list-style-type: none"> ■ 2 pieces, floor installation ■ incl. angle for connecting tub/shower mixer ■ height 775 - 800 mm 	A	B	C	D	E
			659,-	889,-	1.079,-	1.224,-	1.432,-
			F	G	H	I	L
			1.328,-	1.309,-	1.759,-	2.349,-	3.338,-

Empfohlen | Recommended

	109.10.970 Bausatz-Vormontage <ul style="list-style-type: none"> ■ Bodenplatte mit Befestigungsset ■ für Wasserzufuhrstandrohre 632.15.260 	Assembly set for pre-installation <ul style="list-style-type: none"> ■ joint plate with fixing set ■ for water supply pipes 632.15.260 	A				
			459,-				

	632.20.545 Wannenfüll- und Brausebatterie für Standrohrmontage, mit Garnitur <ul style="list-style-type: none"> ■ Ausladung mit Standrohren 231 mm ■ Kartusche mit ker. Scheiben ■ manuelle Umstellung Wanne/Brause ■ Handbrause aus Metall mit einer Strahlart, Anti-Kalk-System und Rückflussverhinderer ■ Metall-Brauseschlauch 1500 mm, beidseitig mit drehbarem Konus 	Tub/shower mixer for supply pipes, incl. shower set <ul style="list-style-type: none"> ■ spout projection with pipes 231 mm ■ cartridge with ceramic discs ■ manual tub/shower diverter ■ metal hand shower with 1 jet, anticalc. system and backflow preventer ■ metal shower hose 1500 mm, both sides with turning cone 	A	B	C	D	E
			669,-	1.222,-	1.568,-	1.809,-	2.485,-
			F	G	H	I	L
			2.209,-	1.176,-	2.124,-	2.789,-	2.999,-

Benötigt | Required

	632.15.260 Wasserzufuhrstandrohre 1/2" <ul style="list-style-type: none"> ■ 2 Stück, in Boden einzuschrauben ■ inkl. Winkelstück zum Anschluß der Wannenfüll- und Brausebatterie ■ Höhe 775 - 800 mm 	Water supply pipes 1/2" <ul style="list-style-type: none"> ■ 2 pieces, floor installation ■ incl. angle for connecting tub/shower mixer ■ height 775 - 800 mm 	A	B	C	D	E
			659,-	889,-	1.079,-	1.224,-	1.432,-
			F	G	H	I	L
			1.328,-	1.309,-	1.759,-	2.349,-	3.338,-

Empfohlen | Recommended

	109.10.970 Bausatz-Vormontage <ul style="list-style-type: none"> ■ Bodenplatte mit Befestigungsset ■ für Wasserzufuhrstandrohre 632.15.260 	Assembly set for pre-installation <ul style="list-style-type: none"> ■ joint plate with fixing set ■ for water supply pipes 632.15.260 	A				
			459,-				

Dusche, Aufputz-Batterien Shower mixer sets, exposed			A	B	C	D	E
	632.20.600 1-Hand Brausebatterie 1/2" für Aufputzmontage <ul style="list-style-type: none"> ■ Kartusche mit keramischen Scheiben ■ Brauseabgang 1/2" ■ verdeckte S-Anschlüsse 1/2" x 3/4" 	Single lever exposed shower mixer 1/2" <ul style="list-style-type: none"> ■ cartridge with ceramic discs ■ discharge 1/2" ■ concealed S-connections 1/2" x 3/4" 	386,-	646,-	829,-	914,-	1.284,-
			F	G	H	I	L
			1.126,-	824,-	1.139,-	1.648,-	2.239,-

A chrom chrome	[.000]	E platin matt platinum matt	[.066]
B silbernickel polished nickel	[.035]	F nerz matt milk matt	[.096]
C nerz milk	[.095]	G schwarz-matt black matt	[.092]
C nickel matt satin nickel	[.036]	H farbig coloured	[.xxx]
D edelmessing sunshine	[.040]	H bronze bronze	[.011]
D platin platinum	[.065]	I gold gold	[.020]
E edelmess.matt sunshine matt	[.041]	L roségold rosegold	[.022]
E gold matt gold matt	[.021]	L roségold matt rosegold matt	[.023]

632.20.660 – Aufputz Set mit Steigrohr | Exposed set with shower system

	649.13.885 Regenbrause ½", ø 250 mm ■ Ausführung ganz in Metall ■ mit Kugelgelenk ■ Anti-Kalk-System	Rain shower head ½", ø 250 mm ■ full metal body ■ with ball joint ■ with anticalcareous system	A	B	C	D	E				
			168,-	359,-	618,-	708,-	1.049,-				
			F	G	H	I	L				
			899,-	589,-	968,-	1.599,-	2.196,-				
	649.20.260 Steigrohr, Umstellung, Wandarm ■ zum Anschluß an die Brausebatterie ■ Ausladung 390 - 410 mm ■ in der Neigung und Höhe verstellbare Brausehalterung			Supply pipe, diverter, wall bracket ■ to connect the exposed shower mixer ■ projection 390 - 410 mm ■ fitting for handshower adjustable in height and inclination			A	B	C	D	E
							398,-	669,-	838,-	996,-	1.276,-
						F	G	H	I	L	
						1.122,-	1.182,-	1.520,-	1.736,-	2.399,-	
632.13.700 Brausegarnitur ■ Handbrause mit 3 Strahlarten, Anti-Kalk-System und Rückflussverhinderer ■ Metall-Brauseschlauch 1500 mm, beidseitig mit drehbarem Konus			Shower combination ■ hand shower with 3 jets, anticalc. system and backflow preventer ■ metal shower hose 1500 mm, both sides with turning cone			A	B	C	D	E	
						139,-	268,-	418,-	479,-	739,-	
						F	G	H	I	L	
						632,-	492,-	798,-	954,-	1.282,-	
Achtung! Dieser Artikel kann nicht in farbig geliefert werden. Attention! This item can not be delivered in coloured.											
632.20.610 Aufputz-Brausebatterie ½" ■ für Steigrohr ■ Hebelmischer- und Umstellkartusche mit keramischen Scheiben ■ verdeckte S-Anschlüsse ½" x ¾"			Exposed shower mixer ½" ■ for supply pipe ■ single lever and diverter cartridge with ceramic discs ■ concealed S-connections ½" x ¾"			A	B	C	D	E	
						396,-	754,-	982,-	1.076,-	1.684,-	
						F	G	H	I	L	
						1.396,-	849,-	1.309,-	1.874,-	2.348,-	

632.20.665 – Aufputz Set mit Steigrohr | Exposed set with shower system

	649.13.885 Regenbrause ½", ø 250 mm ■ Ausführung ganz in Metall ■ mit Kugelgelenk ■ Anti-Kalk-System	Rain shower head ½", ø 250 mm ■ full metal body ■ with ball joint ■ with anticalcareous system	A	B	C	D	E				
			168,-	359,-	618,-	708,-	1.049,-				
			F	G	H	I	L				
			899,-	589,-	968,-	1.599,-	2.196,-				
	649.20.260 Steigrohr, Umstellung, Wandarm ■ zum Anschluß an die Brausebatterie ■ Ausladung 390 - 410 mm ■ in der Neigung und Höhe verstellbare Brausehalterung			Supply pipe, diverter, wall bracket ■ to connect the exposed shower mixer ■ projection 390 - 410 mm ■ fitting for handshower adjustable in height and inclination			A	B	C	D	E
							398,-	669,-	838,-	996,-	1.276,-
						F	G	H	I	L	
						1.122,-	1.182,-	1.520,-	1.736,-	2.399,-	
632.13.705 Brausegarnitur ■ Handbrause aus Metall mit einer Strahlart, Anti-Kalk-System und Rückflussverhinderer ■ Metall-Brauseschlauch 1500 mm, beidseitig mit drehbarem Konus			Shower combination ■ metal hand shower with 1 jet, anticalc. system and backflow preventer ■ metal shower hose 1500 mm, both sides with turning cone			A	B	C	D	E	
						279,-	499,-	546,-	648,-	796,-	
						F	G	H	I	L	
						784,-	598,-	896,-	1.138,-	1.379,-	
632.20.610 Aufputz-Brausebatterie ½" ■ für Steigrohr ■ Hebelmischer- und Umstellkartusche mit keramischen Scheiben ■ verdeckte S-Anschlüsse ½" x ¾"			Exposed shower mixer ½" ■ for supply pipe ■ single lever and diverter cartridge with ceramic discs ■ concealed S-connections ½" x ¾"			A	B	C	D	E	
						396,-	754,-	982,-	1.076,-	1.684,-	
						F	G	H	I	L	
						1.396,-	849,-	1.309,-	1.874,-	2.348,-	

Maßzeichnungen unter www.joerger.de - Menü SERVICE.
 Technical specifications under www.joerger.de - menu SERVICE.

A chrom chrome	[.000]	E platin matt platinum matt	[.066]
B silbernickel polished nickel	[.035]	F nerz matt mink matt	[.096]
C nerz mink	[.095]	G schwarz-matt black matt	[.092]
C nickel matt satin nickel	[.036]	H farbig coloured	[.xxx]
D edelmessing sunshine	[.040]	H bronze bronze	[.011]
D platin platinum	[.065]	I gold gold	[.020]
E edelmess.matt sunshine matt	[.041]	L roségold rosegold	[.022]
E gold matt gold matt	[.021]	L roségold matt rosegold matt	[.023]

632.20.460 – Aufputz Thermostat-Set mit Steigrohr | Exposed thermostat-set with shower system

	<p>649.13.885 Regenbrause ½", ø 250 mm</p> <ul style="list-style-type: none"> ■ Ausführung ganz in Metall ■ mit Kugelgelenk ■ Anti-Kalk-System 	<p>Rain shower head ½", ø 250 mm</p> <ul style="list-style-type: none"> ■ full metal body ■ with ball joint ■ with anticalcareous system 	A	B	C	D	E	
				168,-	359,-	618,-	708,-	1.049,-
				F	G	H	I	L
				899,-	589,-	968,-	1.599,-	2.196,-
	<p>649.20.260 Steigrohr, Umstellung, Wandarm</p> <ul style="list-style-type: none"> ■ zum Anschluß an die Brausebatterie ■ Ausladung 390 - 410 mm ■ in der Neigung und Höhe verstellbare Brausehalterung 	<p>Supply pipe, diverter, wall bracket</p> <ul style="list-style-type: none"> ■ to connect the exposed shower mixer ■ projection 390 - 410 mm ■ fitting for handshower adjustable in height and inclination 	A	B	C	D	E	
			398,-	669,-	838,-	996,-	1.276,-	
		F	G	H	I	L		
		1.122,-	1.182,-	1.520,-	1.736,-	2.399,-		
<p>632.13.700 Brausegarnitur</p> <ul style="list-style-type: none"> ■ Handbrause mit 3 Strahlarten, Anti-Kalk-System und Rückflussverhinderer ■ Metall-Brauseschlauch 1500 mm, beidseitig mit drehbarem Konus 	<p>Shower combination</p> <ul style="list-style-type: none"> ■ hand shower with 3 jets, anticalc. system and backflow preventer ■ metal shower hose 1500 mm, both sides with turning cone 	A	B	C	D	E		
		139,-	268,-	418,-	479,-	739,-		
		F	G	H	I	L		
		632,-	492,-	798,-	954,-	1.282,-		
<p>Achtung! Dieser Artikel kann nicht in farbig geliefert werden. Attention! This item can not be delivered in coloured.</p>								
<p>632.20.260 Brausethermostat ½" für Steigrohr-Montage</p> <ul style="list-style-type: none"> ■ Dehnstoff-Thermoelement ■ Sicherheitssperre bei 38° C ■ Umstellkartusche mit keramischen Scheiben; Brauseabgang ½" ■ verdeckte S-Anschlüsse ½" x ¾" 	<p>Exposed shower thermostat ½" for supply pipe</p> <ul style="list-style-type: none"> ■ cartridge with thermoelement ■ locking device at 38 °C ■ diverter cartridge with ceramic discs; discharge ½" ■ concealed S-connections ½" x ¾" 	A	B	C	D	E		
		479,-	788,-	1.012,-	1.209,-	1.749,-		
		F	G	H	I	L		
		1.464,-	936,-	1.557,-	2.079,-	2.719,-		

632.20.465 – Aufputz Thermostat-Set mit Steigrohr | Exposed thermostat-set with shower system

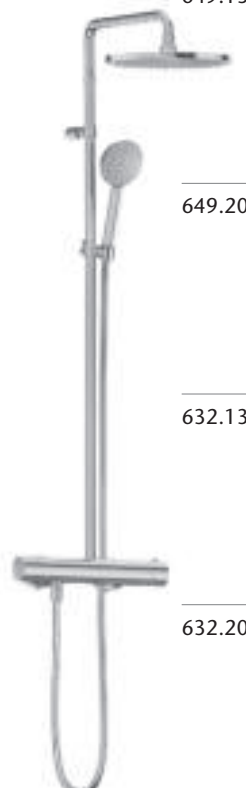
	<p>649.13.885 Regenbrause ½", ø 250 mm</p> <ul style="list-style-type: none"> ■ Ausführung ganz in Metall ■ mit Kugelgelenk ■ Anti-Kalk-System 	<p>Rain shower head ½", ø 250 mm</p> <ul style="list-style-type: none"> ■ full metal body ■ with ball joint ■ with anticalcareous system 	A	B	C	D	E
			168,-	359,-	618,-	708,-	1.049,-
			F	G	H	I	L
			899,-	589,-	968,-	1.599,-	2.196,-
	<p>649.20.260 Steigrohr, Umstellung, Wandarm</p> <ul style="list-style-type: none"> ■ zum Anschluß an die Brausebatterie ■ Ausladung 390 - 410 mm ■ in der Neigung und Höhe verstellbare Brausehalterung 	<p>Supply pipe, diverter, wall bracket</p> <ul style="list-style-type: none"> ■ to connect the exposed shower mixer ■ projection 390 - 410 mm ■ fitting for handshower adjustable in height and inclination 	A	B	C	D	E
			398,-	669,-	838,-	996,-	1.276,-
		F	G	H	I	L	
		1.122,-	1.182,-	1.520,-	1.736,-	2.399,-	
<p>632.13.705 Brausegarnitur</p> <ul style="list-style-type: none"> ■ Handbrause aus Metall mit einer Strahlart, Anti-Kalk-System und Rückflussverhinderer ■ Metall-Brauseschlauch 1500 mm, beidseitig mit drehbarem Konus 	<p>Shower combination</p> <ul style="list-style-type: none"> ■ metal hand shower with 1 jet, anticalc. system and backflow preventer ■ metal shower hose 1500 mm, both sides with turning cone 	A	B	C	D	E	
		279,-	499,-	546,-	648,-	796,-	
		F	G	H	I	L	
		784,-	598,-	896,-	1.138,-	1.379,-	
<p>632.20.260 Brausethermostat ½" für Steigrohr-Montage</p> <ul style="list-style-type: none"> ■ Dehnstoff-Thermoelement ■ Sicherheitssperre bei 38° C ■ Umstellkartusche mit keramischen Scheiben; Brauseabgang ½" ■ verdeckte S-Anschlüsse ½" x ¾" 	<p>Exposed shower thermostat ½" for supply pipe</p> <ul style="list-style-type: none"> ■ cartridge with thermoelement ■ locking device at 38 °C ■ diverter cartridge with ceramic discs; discharge ½" ■ concealed S-connections ½" x ¾" 	A	B	C	D	E	
		479,-	788,-	1.012,-	1.209,-	1.749,-	
		F	G	H	I	L	
		1.464,-	936,-	1.557,-	2.079,-	2.719,-	

A chrom chrome	[.000]	E platin matt platinum matt	[.066]
B silbernickel polished nickel	[.035]	F nerz matt mink matt	[.096]
C nerz mink	[.095]	G schwarz-matt black matt	[.092]
C nickel matt satin nickel	[.036]	H farbig coloured	[.xxx]
D edelmessing sunshine	[.040]	H bronze bronze	[.011]
D platin platinum	[.065]	I gold gold	[.020]
E edelmess.matt sunshine matt	[.041]	L roségold rosegold	[.022]
E gold matt gold matt	[.021]	L roségold matt rosegold matt	[.023]

Unterputz-Hebelmischer 1/2" | Concealed single lever mixer 1/2"



632.20.125	1-Hand Wannenfüll- und Brausebatterie 1/2" für UP-Montage, Fertigmontageset	<ul style="list-style-type: none"> manuelle, keramische Umstellung für druckunabhängige Funktion mit Sicherheitseinrichtung Durchflussrate 21 l/min bei 3 bar 	Concealed single lever wall tub and shower mixer 1/2", assembly set	A	B	C	D	E
				599,-	1.018,-	1.084,-	1.144,-	1.378,-
		<ul style="list-style-type: none"> manual, ceramic diverter tub/shower for pressure-independent function with safety device flow rate 21 l/min at 3 bar 		F	G	H	I	L
				1.266,-	949,-	1.326,-	1.552,-	1.899,-

Variante | Alternative



632.20.135	1-Hand Wannenfüll- und Brausebatterie 1/2" für UP-Montage, Fertigmontageset	<ul style="list-style-type: none"> manuelle, keramische Umstellung für druckunabhängige Funktion ohne Sicherheitseinrichtung Durchflussrate 21 l/min bei 3 bar 	Concealed single lever wall tub and shower mixer 1/2", assembly set	A	B	C	D	E
				528,-	948,-	1.016,-	1.084,-	1.356,-
		<ul style="list-style-type: none"> manual, ceramic diverter tub/shower for pressure-independent function without safety device flow rate 21 l/min at 3 bar 		F	G	H	I	L
				1.234,-	919,-	1.226,-	1.452,-	1.799,-

Variante | Alternative



632.20.245	1-Hand Brausebatterie 1/2" für UP-Montage, Fertigmontageset	<ul style="list-style-type: none"> ohne Umstellung Funktionseinheit mit ker. Scheiben Durchflussrate 20,4 l/min bei 3 bar 	Concealed single lever shower mixer 1/2", assembly set	A	B	C	D	E
				398,-	848,-	914,-	974,-	1.208,-
		<ul style="list-style-type: none"> without diverter functional unit with ceramic discs flow rate 20,4 l/min at 3 bar 		F	G	H	I	L
				1.096,-	719,-	1.156,-	1.382,-	1.729,-

Benötigt | Required



649.40.360	Unterputz-Einbaubox 1/2"	<ul style="list-style-type: none"> zu Fertigmontageset 632.20.125 und 632.20.235 für Nass- und Trockenbau geeignet 	Concealed wall box 1/2"	A				
				168,-				
		<ul style="list-style-type: none"> for assembly set 632.20.125 and 632.20.235 for wetwall and drywall construction 		F				

Unterputz-Thermostate 1/2" | Wall thermostats, concealed 1/2"



632.40.380	Unterputz-Thermostat 1/2" mit Mengenregulierung, Fertigmontageset	<ul style="list-style-type: none"> manuelle, keramische Umstellung Wanne/Brause, druckunabhängig mit Sicherheitseinrichtung Durchflussrate 20,4 l/min bei 3 bar 	Concealed wall thermostat 1/2" with flow control, assembly set	A	B	C	D	E
				1.074,-	1.192,-	1.245,-	1.398,-	1.684,-
		<ul style="list-style-type: none"> manual, ceramic diverter tub/shower for pressure-independent function with safety device flow rate 20,4 l/min at 3 bar 		F	G	H	I	L
				1.516,-	1.269,-	1.499,-	1.982,-	2.328,-

Variante | Alternative



632.40.360	Unterputz-Thermostat 1/2" mit Mengenregulierung, Fertigmontageset	<ul style="list-style-type: none"> ohne Umstellung mit integrierter keramischer Mengenregulierung Durchflussrate 20,4 l/min bei 3 bar 	Concealed wall thermostat 1/2" with flow control, assembly set	A	B	C	D	E
				1.049,-	1.178,-	1.230,-	1.382,-	1.654,-
		<ul style="list-style-type: none"> without diverter with integrated ceramic cartridge for volume control flow rate 20,4 l/min at 3 bar 		F	G	H	I	L
				1.489,-	1.254,-	1.484,-	1.946,-	2.332,-

Variante | Alternative



615.40.460	Unterputz-Thermostat 1/2" ohne Mengenregulierung, Fertigmontageset	<ul style="list-style-type: none"> Funktionseinheit ohne Umstellung und ohne Absperrung Durchflussrate 25,8 l/min bei 3 bar 	Concealed wall thermostat 1/2" without flow control, assembly set	A	B	C	D	E
				898,-	1.028,-	1.192,-	1.226,-	1.486,-
		<ul style="list-style-type: none"> Functional unit without diverter and without shut-off flow rate 25,8 l/min at 3 bar 		F	G	H	I	L
				1.368,-	1.192,-	1.434,-	1.679,-	2.153,-

Benötigt | Required





649.40.360	Unterputz-Einbaubox 1/2"	<ul style="list-style-type: none"> zu Fertigmontageset 632.40.360 und 615.40.460 für Nass- und Trockenbau geeignet 	Concealed wall box 1/2"	A				
				168,-				
		<ul style="list-style-type: none"> for assembly set 632.40.360 and 615.40.460 for wetwall and drywall construction 		F				



Maßzeichnungen unter www.joerger.de - Menü SERVICE.
 Technical specifications under www.joerger.de - menu SERVICE.

A chrom chrome	[.000]	E platin matt platinum matt	[.066]
B silbernickel polished nickel	[.035]	F nerz matt mink matt	[.096]
C nerz mink	[.095]	G schwarz-matt black matt	[.092]
C nickel matt satin nickel	[.036]	H farbig coloured	[.xxx]
D edelmessing sunshine	[.040]	H bronze bronze	[.011]
D platin platinum	[.065]	I gold gold	[.020]
E edelmess.matt sunshine matt	[.041]	L roségold rosegold	[.022]
E gold matt gold matt	[.021]	L roségold matt rosegold matt	[.023]





Unterputz-Thermostat 3/4" mit hohem Durchfluß | Wall thermostat, concealed 3/4" with high flow

	615.40.555 Unterputz-Thermostat 3/4" ohne Mengenregulierung, Fertigmontageset <ul style="list-style-type: none"> ■ serienbezogener Temperiergriff ■ Sicherheitssperre bei 38° C 	Concealed wall thermostat 3/4" without flow control, assembly set	A	B	C	D	E
			586,-	686,-	748,-	795,-	1.064,-
			F	G	H	I	L
			952,-	626,-	779,-	1.239,-	1.858,-
Benötigt Required							
	649.40.555 Unterputz-Einbaukörper 3/4" <ul style="list-style-type: none"> ■ zu Fertigmontageset 615.40.555 ■ Kartusche mit Schmutzfangsieben ■ für Nass- und Trockenbau geeignet ■ Durchflussrate 64,2 l/min bei 3 bar ■ ohne Absperrung 	Concealed thermostat body 3/4"	A				
			1.636,-				



Unterputz-Thermostat 3/4" | Wall thermostat, concealed 3/4"

	615.40.520 Unterputz-Thermostat 3/4" ohne Mengenregulierung, Fertigmontageset <ul style="list-style-type: none"> ■ serienbezogener Temperiergriff ■ Sicherheitssperre bei 38° C 	Concealed wall thermostat 3/4" without flow control, assembly set	A	B	C	D	E
			586,-	686,-	748,-	795,-	1.064,-
			F	G	H	I	L
			952,-	626,-	779,-	1.239,-	1.858,-
Benötigt Required							
	649.40.520 Unterputz-Einbaukörper 3/4" <ul style="list-style-type: none"> ■ zu Fertigmontageset 615.40.520 ■ Kartusche mit Schmutzfangsieben ■ für Nass- und Trockenbau geeignet ■ Durchflussrate 41 l/min bei 3 bar ■ ohne Absperrung 	Concealed thermostat body 3/4"	A				
			498,-				

Unterputz-Ventile | Valves concealed











	632.50.234 Unterputz-Ventil Fertigmontageset <ul style="list-style-type: none"> ■ Griff ■ Hülse, Schubrosette 	Concealed wall valve assembly set	A	B	C	D	E
			189,-	238,-	264,-	279,-	359,-
			F	G	H	I	L
			319,-	318,-	412,-	469,-	612,-
Benötigt Required							
	649.20.350 Unterputz-Ventil 1/2", Einbaukörper <ul style="list-style-type: none"> ■ rechtsschließend, ker. Scheiben 	Concealed wall valve 1/2", body	A				
			66,-				
	649.20.355 Unterputz-Ventil 1/2", Einbaukörper <ul style="list-style-type: none"> ■ linksschließend, ker. Scheiben 	Concealed wall valve 1/2", body					
	649.20.450 Unterputz-Ventil 3/4", Einbaukörper <ul style="list-style-type: none"> ■ rechtsschließend, ker. Scheiben 	Concealed wall valve 3/4", body	A				
			99,-				
	649.20.455 Unterputz-Ventil 3/4", Einbaukörper <ul style="list-style-type: none"> ■ linksschließend, ker. Scheiben 	Concealed wall valve 3/4", body					

Unterputz-Umstellung | Diverter concealed

	632.40.650 Unterputz 3-Wege Umstellung 1/2" Fertigmontageset <ul style="list-style-type: none"> ■ Griff ■ Hülse, Schubrosette 	Concealed 3-position diverter 1/2" assembly set	A	B	C	D	E
			199,-	248,-	274,-	289,-	369,-
			F	G	H	I	L
			329,-	328,-	422,-	479,-	622,-
Benötigt Required							
	649.40.600 Unterputz 3-Wege Umstellung 1/2" Einbaukörper <ul style="list-style-type: none"> ■ zu Fertigmontageset 632.40.650 	Concealed 3-position diverter 1/2" diverter body	A				
			236,-				

A chrom chrome	[.000]	E platin matt platinum matt	[.066]
B silbernickel polished nickel	[.035]	F nerz matt milk matt	[.096]
C nerz milk	[.095]	G schwarz-matt black matt	[.092]
C nickel matt satin nickel	[.036]	H farbig coloured	[.xxx]
D edelmessing sunshine	[.040]	H bronze bronze	[.011]
D platin platinum	[.065]	I gold gold	[.020]
E edelmess.matt sunshine matt	[.041]	L roségold rosegold	[.022]
E gold matt gold matt	[.021]	L roségold matt rosegold matt	[.023]

Unterputz-Thermostat/Ventil-Modul | Concealed thermostatic/wall-valve modul

		A	B	C	D	E
	632.60.432 Unterputz-Ventil-Modul Fertigmontageset ■ Griff ■ Rosette	Concealed wall-valve-modul assembly set ■ design handle ■ escutcheon		209,-	258,-	284,-
			339,-	338,-	432,-	489,-
	Benötigt Required					
	649.20.610 Unterputz-Ventil-Modul, 1-fach ■ 1x Spindelventil 3/4", rechts-schließend mit keram. Scheiben ■ 2 Abgänge 1/2", je 1x rechts/links möglich, gleichzeitig benutzbar	Concealed wall-valve-modul, single ■ 1x spindle valve 3/4", clockwise closure with ceramic discs ■ 2 outlets 1/2", each 1x right/left possible, simultaneously usable		229,-		
	Benötigt Required					
	649.20.620 Unterputz-Ventil-Modul, 2-fach ■ 2x Spindelventil 3/4", rechts-schließend mit keram. Scheiben ■ 4 Abgänge 1/2", je 2x rechts/links möglich, gleichzeitig benutzbar ■ im Verbund maßgenaue Montage ■ erweiterbar mit 649.20.610	Concealed wall-valve-modul, double ■ 2x spindle valve 3/4", clockwise closure with ceramic discs ■ 4 outlets 1/2", each 2x right/left possible, simultaneously usable ■ precise assembly due to composite ■ expandable with 649.20.610		458,-		
	Benötigt Required					
	649.20.630 Unterputz-Ventil-Modul, 3-fach ■ 3x Spindelventil 3/4", rechts-schließend mit keram. Scheiben ■ 6 Abgänge 1/2", je 3x rechts/links möglich, gleichzeitig benutzbar ■ im Verbund maßgenauen Montage ■ erweiterbar mit 649.20.610	Concealed wall-valve-modul, triple ■ 3x spindle valve 3/4", clockwise closure with ceramic discs ■ 6 outlets 1/2", each 3x right/left possible, simultaneously usable ■ precise assembly due to composite ■ expandable with 649.20.610		686,-		
	Benötigt Required					
	615.40.460 Unterputz-Thermostat 1/2" ohne Mengenregulierung, Fertigmontageset ■ Funktionseinheit ohne Umstellung und ohne Absperrung ■ Durchflussrate 25,8 l/min bei 3 bar	Concealed wall thermostat 1/2" <u>without</u> flow control, assembly set ■ Functional unit <u>without</u> diverter and <u>without</u> shut-off ■ flow rate 25,8 l/min at 3 bar		898,-	1.028,-	1.192,-
			1.368,-	1.192,-	1.434,-	1.679,-
	Benötigt Required					
	649.20.612 Anschlußadapter 1/2" ■ Anschlußadapter, Abschlußstopfen ■ passend zu Einbaubox 649.40.360	Connection adapter 1/2" ■ connection adapter, end plug ■ matching to wall box 649.40.360		122,-		
	Benötigt Required					
	649.40.360 Unterputz-Einbaubox 1/2" ■ zu Fertigmontageset 615.40.460 ■ für Nass- und Trockenbau geeignet	Concealed wall box 1/2" ■ for assembly set 615.40.460 ■ for wetwall and drywall construction		168,-		
	Benötigt Required					
	615.40.555 Unterputz-Thermostat 3/4" ohne Mengenregulierung, Fertigmontageset ■ serienbezogener Temperiergriff ■ Sicherheitssperre bei 38° C	Concealed wall thermostat 3/4" <u>without</u> flow control, assembly set ■ design handle for temp. control ■ locking device at 38° C		586,-	686,-	748,-
			952,-	626,-	779,-	1.239,-
	Benötigt Required					
	649.20.634 Anschlußadapter 3/4" ■ Anschlußadapter, Abschlußstopfen ■ passend zu Einbaukörper 649.40.555	Connection adapter 3/4" ■ connection adapter, end plug ■ matching to wall body 649.40.555		146,-		
	Benötigt Required					
	649.40.555 Unterputz-Einbaukörper 3/4" ■ zu Fertigmontageset 615.40.555 ■ Kartusche mit Schmutzfangsieben ■ für Nass- und Trockenbau geeignet ■ Durchflussrate 64,2 l/min bei 3 bar ■ ohne Absperrung	Concealed thermostat body 3/4" ■ for assembly set 615.40.555 ■ cartridge with filter screens ■ for wetwall and drywall construction ■ flow rate 64,2 l/min at 3 bar ■ <u>without</u> shut-off		1.636,-		
	Benötigt Required					

Maßzeichnungen unter www.joerger.de - Menü SERVICE.
 Technical specifications under www.joerger.de - menu SERVICE.

A chrom chrome	[.000]	E platin matt platinum matt	[.066]
B silbernickel polished nickel	[.035]	F nerz matt milk matt	[.096]
C nerz milk	[.095]	G schwarz-matt black matt	[.092]
C nickel matt satin nickel	[.036]	H farbig coloured	[.xxx]
D edelmessing sunshine	[.040]	H bronze bronze	[.011]
D platin platinum	[.065]	I gold gold	[.020]
E edelmess.matt sunshine matt	[.041]	L roségold rosegold	[.022]
E gold matt gold matt	[.021]	L roségold matt rosegold matt	[.023]

Bräusen | Showers



- 632.13.300 Duschgarnitur, komplett**
- Wandrohr 800 mm, mit Schieber
 - Handbrause mit 3 Strahlarten, Anti-Kalk-System und Rückflussverhinderer
 - Metall-Brauseschlauch 1750 mm, beidseitig mit drehbarem Konus

- Shower bar set, complete**
- wall bar 800 mm, with slider
 - hand shower with 3 jets, anticalc. system and backflow preventer
 - metal shower hose 1750 mm, both sides with turning cone

Achtung! Dieser Artikel kann nicht in farbig geliefert werden.
Attention! This item can not be delivered in coloured.

A	B	C	D	E
198,-	666,-	944,-	1.065,-	1.624,-
F	G	H	I	L
1.398,-	986,-	1.499,-	1.859,-	2.824,-



- 632.13.305 Duschgarnitur, komplett**
- Wandrohr 800 mm, mit Schieber
 - Handbrause aus Metall mit einer Strahlart, Anti-Kalk-System und Rückflussverhinderer
 - Metall-Brauseschlauch 1750 mm, beidseitig mit drehbarem Konus

- Shower bar set, complete**
- wall bar 800 mm, with slider
 - metal hand shower with 1 jet, anticalc. system and backflow preventer
 - metal shower hose 1750 mm, both sides with turning cone

A	B	C	D	E
139,-	387,-	515,-	574,-	849,-
F	G	H	I	L
739,-	509,-	745,-	1.098,-	1.709,-

A	B	C	D	E
319,-	774,-	1.022,-	1.132,-	1.674,-
F	G	H	I	L
1.458,-	1.092,-	1.596,-	1.898,-	2.919,-



- 632.13.210 Schlauchbrausegarnitur**
- Wandanschlußbogen 1/2", Schubrosette
 - Wand-Brausehalter
 - Handbrause mit 3 Strahlarten, Anti-Kalk-System und Rückflussverhinderer
 - Metall-Brauseschlauch 1500 mm, beidseitig mit drehbarem Konus

- Shower combination**
- wall elbow connection 1/2", escutcheon
 - wall fitting for hand shower
 - hand shower with 3 jets, anticalc. system and backflow preventer
 - metal shower hose 1500 mm, both sides with turning cone

Achtung! Dieser Artikel kann nicht in farbig geliefert werden.
Attention! This item can not be delivered in coloured.

A	B	C	D	E
216,-	389,-	532,-	594,-	889,-
F	G	H	I	L
772,-	628,-	978,-	1.114,-	1.489,-



- 632.13.215 Schlauchbrausegarnitur**
- Wandanschlußbogen 1/2", Schubrosette
 - Wand-Brausehalter
 - Handbrause aus Metall mit einer Strahlart, Anti-Kalk-System und Rückflussverhinderer
 - Metall-Brauseschlauch 1500 mm, beidseitig mit drehbarem Konus

- Shower combination**
- wall elbow connection 1/2", escutcheon
 - wall fitting for hand shower
 - metal hand shower with 1 jet, anticalc. system and backflow preventer
 - metal shower hose 1500 mm, both sides with turning cone

A	B	C	D	E
337,-	499,-	608,-	662,-	934,-
F	G	H	I	L
826,-	734,-	1.068,-	1.198,-	1.586,-



- 632.13.150 Wandanschlußbogen 1/2", ohne Haken**
- Brauseabgang 1/2"
 - mit Rückflussverhinderer, Rosette

- Wall elbow connection 1/2", without cradle**
- discharge 1/2"
 - with backflow preventer, escutcheon

A	B	C	D	E
89,-	98,-	106,-	112,-	178,-
F	G	H	I	L
152,-	148,-	187,-	239,-	306,-









- 632.13.270 Wand-Brausehalter**

- Wall fitting for hand shower**

A	B	C	D	E
79,-	79,-	89,-	99,-	158,-
F	G	H	I	L
132,-	114,-	154,-	198,-	296,-

A chrom chrome	[.000]	E platin matt platinum matt	[.066]
B silbernickel polished nickel	[.035]	F nerz matt milk matt	[.096]
C nerz milk	[.095]	G schwarz-matt black matt	[.092]
C nickel matt satin nickel	[.036]	H farbig coloured	[.xxx]
D edelmessing sunshine	[.040]	H bronze bronze	[.011]
D platin platinum	[.065]	I gold gold	[.020]
E edelmess.matt sunshine matt	[.041]	L roségold rosegold	[.022]
E gold matt gold matt	[.021]	L roségold matt rosegold matt	[.023]

	619.13.237 Hygienebrausegarnitur <ul style="list-style-type: none"> Wandbrausehalter und -anschlußbogen 1/2", Schubrosette Hygienebrause, modern (649.13.337), komplett aus Metall einstrahlig, Bedienung über Druckhebel Metall-Brauseschlauch 1250 mm 	Ablution spray combination <ul style="list-style-type: none"> wall fitting and elbow connection 1/2" spray handshower, modern (649.13.337), completely metal one jet, push-lever operation flexible metal shower hose 1250 mm 	<table border="1"> <thead> <tr><th>A</th><th>B</th><th>C</th><th>D</th><th>E</th></tr> </thead> <tbody> <tr><td>271,-</td><td>436,-</td><td>489,-</td><td>569,-</td><td>668,-</td></tr> <tr><th>F</th><th>G</th><th>H</th><th>I</th><th>L</th></tr> <tr><td>629,-</td><td>659,-</td><td>994,-</td><td>1.169,-</td><td>1.532,-</td></tr> </tbody> </table>	A	B	C	D	E	271,-	436,-	489,-	569,-	668,-	F	G	H	I	L	629,-	659,-	994,-	1.169,-	1.532,-
	A	B	C	D	E																		
271,-	436,-	489,-	569,-	668,-																			
F	G	H	I	L																			
629,-	659,-	994,-	1.169,-	1.532,-																			
	615.20.237 1-Hand Batterie 1/2" für Hygiene-Brause, Fertigmontageset <ul style="list-style-type: none"> Rosette, Griff 	Concealed single lever 1/2" for ablution spray, assembly set <ul style="list-style-type: none"> escutcheon, handle 	<table border="1"> <thead> <tr><th>A</th><th>B</th><th>C</th><th>D</th><th>E</th></tr> </thead> <tbody> <tr><td>271,-</td><td>359,-</td><td>439,-</td><td>496,-</td><td>580,-</td></tr> <tr><th>F</th><th>G</th><th>H</th><th>I</th><th>L</th></tr> <tr><td>549,-</td><td>439,-</td><td>526,-</td><td>658,-</td><td>729,-</td></tr> </tbody> </table>	A	B	C	D	E	271,-	359,-	439,-	496,-	580,-	F	G	H	I	L	549,-	439,-	526,-	658,-	729,-
	A	B	C	D	E																		
271,-	359,-	439,-	496,-	580,-																			
F	G	H	I	L																			
549,-	439,-	526,-	658,-	729,-																			
	649.20.237 Unterputz 1-Hand Batterie 1/2", Einbaukörper <ul style="list-style-type: none"> Kartusche mit keramischen Scheiben zu Fertigmontageset 615.20.237 	Single lever mixer 1/2", concealed body <ul style="list-style-type: none"> cartridge with ceramic discs for assembly set 615.20.237 	<table border="1"> <thead> <tr><th>A</th><th>B</th><th>C</th><th>D</th><th>E</th></tr> </thead> <tbody> <tr><td>125,-</td><td>169,-</td><td>208,-</td><td>229,-</td><td>268,-</td></tr> <tr><th>F</th><th>G</th><th>H</th><th>I</th><th>L</th></tr> <tr><td>249,-</td><td>224,-</td><td>258,-</td><td>329,-</td><td>396,-</td></tr> </tbody> </table>	A	B	C	D	E	125,-	169,-	208,-	229,-	268,-	F	G	H	I	L	249,-	224,-	258,-	329,-	396,-
	A	B	C	D	E																		
125,-	169,-	208,-	229,-	268,-																			
F	G	H	I	L																			
249,-	224,-	258,-	329,-	396,-																			
	649.13.885 Regenbrause 1/2", ø 250 mm <ul style="list-style-type: none"> Ausführung Metall mit Kugelgelenk Anti-Kalk-System weitere, zur Serie passende Kopfbrausen siehe Kapitel "Brausen" 	Rain shower head 1/2", ø 250 mm <ul style="list-style-type: none"> material metal with ball joint with anticalcareous system for further shower heads matching this collection see chapter "showers" 	<table border="1"> <thead> <tr><th>A</th><th>B</th><th>C</th><th>D</th><th>E</th></tr> </thead> <tbody> <tr><td>168,-</td><td>359,-</td><td>618,-</td><td>708,-</td><td>1.049,-</td></tr> <tr><th>F</th><th>G</th><th>H</th><th>I</th><th>L</th></tr> <tr><td>899,-</td><td>589,-</td><td>968,-</td><td>1.599,-</td><td>2.196,-</td></tr> </tbody> </table>	A	B	C	D	E	168,-	359,-	618,-	708,-	1.049,-	F	G	H	I	L	899,-	589,-	968,-	1.599,-	2.196,-
	A	B	C	D	E																		
168,-	359,-	618,-	708,-	1.049,-																			
F	G	H	I	L																			
899,-	589,-	968,-	1.599,-	2.196,-																			
	649.13.755 Wandarm 1/2" <ul style="list-style-type: none"> Ausladung 350 mm weitere, zur Serie passende Wandarme siehe Kapitel "Brausen" 	Wall bracket 1/2" <ul style="list-style-type: none"> projection 350 mm for further wall brackets matching this collection see chapter "showers" 	<table border="1"> <thead> <tr><th>A</th><th>B</th><th>C</th><th>D</th><th>E</th></tr> </thead> <tbody> <tr><td>129,-</td><td>288,-</td><td>316,-</td><td>349,-</td><td>439,-</td></tr> <tr><th>F</th><th>G</th><th>H</th><th>I</th><th>L</th></tr> <tr><td>399,-</td><td>288,-</td><td>328,-</td><td>479,-</td><td>539,-</td></tr> </tbody> </table>	A	B	C	D	E	129,-	288,-	316,-	349,-	439,-	F	G	H	I	L	399,-	288,-	328,-	479,-	539,-
	A	B	C	D	E																		
129,-	288,-	316,-	349,-	439,-																			
F	G	H	I	L																			
399,-	288,-	328,-	479,-	539,-																			
	649.13.519 Seitenbrause 1/2" <ul style="list-style-type: none"> Rosette ø 130 mm, Wandmontage Brausekopf schwenkbar, 20° Anti-Kalk-System Material: Kunststoff weitere, zur Serie passende Seitenbrausen siehe Kapitel "Brausen" 	Body spray side shower 1/2" <ul style="list-style-type: none"> escutcheon ø 130 mm, wall assembly swivel shower head, 20° anticalcareous system plastic for further side showers matching this collection see chapter "showers" 	<table border="1"> <thead> <tr><th>A</th><th>B</th><th>C</th><th>D</th><th>E</th></tr> </thead> <tbody> <tr><td>167,-</td><td>326,-</td><td>385,-</td><td>399,-</td><td>542,-</td></tr> <tr><th>F</th><th>G</th><th>H</th><th>I</th><th>L</th></tr> <tr><td>496,-</td><td>376,-</td><td>472,-</td><td>634,-</td><td>949,-</td></tr> </tbody> </table>	A	B	C	D	E	167,-	326,-	385,-	399,-	542,-	F	G	H	I	L	496,-	376,-	472,-	634,-	949,-
	A	B	C	D	E																		
167,-	326,-	385,-	399,-	542,-																			
F	G	H	I	L																			
496,-	376,-	472,-	634,-	949,-																			
	649.13.381 Handbrause 1/2" <ul style="list-style-type: none"> Anti-Kalk-System 3 Strahlarten: Normal, Soft, Schwall Anschluß 1/2" Ausführung ABS weitere, zur Serie passende Handbrausen siehe Kapitel "Brausen" 	Hand shower 1/2" <ul style="list-style-type: none"> anticalcareous system with 3 jets: normal, soft, cascade connection 1/2" material ABS for further hand showers matching this collection see chapter "showers" 	<table border="1"> <thead> <tr><th>A</th><th>B</th><th>C</th><th>D</th><th>E</th></tr> </thead> <tbody> <tr><td>69,-</td><td>172,-</td><td>259,-</td><td>299,-</td><td>476,-</td></tr> <tr><th>F</th><th>G</th><th>H</th><th>I</th><th>L</th></tr> <tr><td>392,-</td><td>289,-</td><td>449,-</td><td>668,-</td><td>869,-</td></tr> </tbody> </table>	A	B	C	D	E	69,-	172,-	259,-	299,-	476,-	F	G	H	I	L	392,-	289,-	449,-	668,-	869,-
	A	B	C	D	E																		
69,-	172,-	259,-	299,-	476,-																			
F	G	H	I	L																			
392,-	289,-	449,-	668,-	869,-																			
<p>Achtung! Dieser Artikel kann nicht in farbig geliefert werden. Attention! This item can not be delivered in coloured.</p>																							

Maßzeichnungen unter www.joerger.de - Menü SERVICE.
 Technical specifications under www.joerger.de - menu SERVICE.

A chrom chrome	[.000]	E platin matt platinum matt	[.066]
B silbernickel polished nickel	[.035]	F nerz matt mink matt	[.096]
C nerz mink	[.095]	G schwarz-matt black matt	[.092]
C nickel matt satin nickel	[.036]	H farbig coloured	[.xxx]
D edelmessing sunshine	[.040]	H bronze bronze	[.011]
D platin platinum	[.065]	I gold gold	[.020]
E edelmess.matt sunshine matt	[.041]	L roségold rosegold	[.022]
E gold matt gold matt	[.021]	L roségold matt rosegold matt	[.023]



649.13.391 Handbrause 1/2"

- Anti-Kalk-System
- Anschluß 1/2"
- Ausführung Metall
- weitere, zur Serie passende Handbrausen siehe Kapitel "Brausen"

Hand shower 1/2"

- anticalcareous system
- connection 1/2"
- material metal
- for further hand showers matching this collection see chapter "showers"

A	B	C	D	E
208,-	398,-	426,-	464,-	578,-
F	G	H	I	L
546,-	394,-	586,-	718,-	956,-

Accessoires für Handtücher | Accessories for towels



632.00.002 Handtuchhalter

- Rohre beweglich, ca. 400 mm

Towel bar

- swivel bars, approx. 400 mm

A	B	C	D	E
89,-	249,-	378,-	464,-	718,-
F	G	H	I	L
612,-	329,-	464,-	829,-	969,-



632.00.004 Handtuchhalter

- Rohr starr, ca. 400 mm

Towel bar

- rigid bar, approx. 400 mm

A	B	C	D	E
69,-	198,-	234,-	256,-	324,-
F	G	H	I	L
292,-	245,-	342,-	464,-	728,-



632.00.047 Handtuchring

Towel ring

A	B	C	D	E
75,-	225,-	399,-	433,-	572,-
F	G	H	I	L
506,-	238,-	326,-	679,-	784,-



632.00.022 Handtuchhaken

Robe hanger

A	B	C	D	E
25,-	45,-	62,-	99,-	129,-
F	G	H	I	L
116,-	86,-	128,-	146,-	199,-



632.00.040 Badetuchhalter

- ca. 800 mm

Bath towel bar

- approx. 800 mm

A	B	C	D	E
87,-	248,-	334,-	408,-	596,-
F	G	H	I	L
512,-	299,-	584,-	759,-	1.399,-

A chrom chrome	[.000]	E platin matt platinum matt	[.066]
B silbernickel polished nickel	[.035]	F nerz matt milk matt	[.096]
C nerz milk	[.095]	G schwarz-matt black matt	[.092]
C nickel matt satin nickel	[.036]	H farbig coloured	[.xxx]
D edelmessing sunshine	[.040]	H bronze bronze	[.011]
D platin platinum	[.065]	I gold gold	[.020]
E edelmess.matt sunshine matt	[.041]	L roségold rosegold	[.022]
E gold matt gold matt	[.021]	L roségold matt rosegold matt	[.023]

	632.00.041 Badetuchhalter, doppelt ■ ca. 600 mm	Bath towel bar, double ■ approx. 600 mm	A	B	C	D	E
			118,-	422,-	594,-	742,-	1.084,-
			F	G	H	I	L
			928,-	482,-	846,-	1.474,-	1.996,-

	632.00.048 Badetuch-Ablage ■ ca. 600 x 260 mm	Bath towel shelf ■ approx. 600 x 260 mm	A	B	C	D	E
			187,-	536,-	886,-	1.069,-	1.649,-
			F	G	H	I	L
			1.389,-	608,-	1.335,-	1.842,-	2.678,-

	632.00.031 Wannengriff ■ ca. 300 mm	Tub handle ■ approx. 300 mm	A	B	C	D	E
			76,-	212,-	309,-	342,-	512,-
			F	G	H	I	L
			436,-	278,-	426,-	609,-	862,-

	634.00.104 Gästehandtuchkorb, eckig ■ mit Ablage ■ Korbgröße 260 x 150 x 190 mm	Guest towel basket, angular ■ with shelf ■ basket size 260 x 150 x 190 mm	A	B	C	D	E
			230,-	314,-	356,-	389,-	528,-
			F	G	H	I	L
			466,-	492,-	675,-	849,-	1.499,-

Accessoires für Waschplatz | Accessories for washstands

	632.00.007 Seifenhalter, komplett ■ Wandmodell ■ Seifenschale aus Kristallglas, seidenmatt	Soap dish holder, complete ■ wall version ■ crystal glass dish, frosted	A	B	C	D	E
			49,-	94,-	154,-	226,-	293,-
			F	G	H	I	L
			258,-	152,-	229,-	318,-	369,-

	732.00.307 Seifenschale, lose	Glass dish, separate	A				
			19,-				

	632.00.017 Seifenhalter, komplett ■ Standmodell ■ Seifenschale aus Kristallglas, seidenmatt	Soap dish holder, complete ■ free standing version ■ crystal glass dish, frosted	A	B	C	D	E
			44,-	84,-	108,-	169,-	215,-
			F	G	H	I	L
			189,-	179,-	214,-	279,-	369,-

	632.00.005 Lotionsspender, komplett ■ Wandmodell ■ Einfache Befüllung von oben ■ Betätigung von unten ■ Dosiermenge: 0,5 ml/Hub	Soap dispenser, complete ■ wall version ■ easy filling from above ■ actuation from below ■ dosage: 0.5 ml / stroke	A	B	C	D	E
			116,-	179,-	219,-	254,-	359,-
			F	G	H	I	L
			289,-	268,-	356,-	468,-	728,-

Maßzeichnungen unter www.joerger.de - Menü SERVICE.
 Technical specifications under www.joerger.de - menu SERVICE.

A chrom chrome	[.000]	E platin matt platinum matt	[.066]
B silbernickel polished nickel	[.035]	F nerz matt mink matt	[.096]
C nerz mink	[.095]	G schwarz-matt black matt	[.092]
C nickel matt satin nickel	[.036]	H farbig coloured	[.xxx]
D edelmessing sunshine	[.040]	H bronze bronze	[.011]
D platin platinum	[.065]	I gold gold	[.020]
E edelmess.matt sunshine matt	[.041]	L roségold rosegold	[.022]
E gold matt gold matt	[.021]	L roségold matt rosegold matt	[.023]

	632.00.016 Lotionspender, komplett ■ Standmodell ■ Ausführung Metall	Soap dispenser, complete ■ free standing version ■ brass	A	B	C	D	E
			67,-	169,-	272,-	335,-	534,-
			F	G	H	I	L
			446,-	308,-	484,-	738,-	989,-

	634.00.105 Schwammkorb ■ rechteckig, 260 x 130 mm	Sponge basket ■ rectangular, 260 x 130 mm	A	B	C	D	E
			199,-	238,-	279,-	332,-	462,-
			F	G	H	I	L
			396,-	348,-	459,-	589,-	859,-

	634.00.106 Eckschwammkorb ■ 195 x 195 mm	Corner sponge basket ■ 195 x 195 mm	A	B	C	D	E
			195,-	234,-	275,-	328,-	458,-
			F	G	H	I	L
			390,-	344,-	455,-	585,-	855,-

	632.00.036 Glashalter, komplett ■ Wandmodell ■ Glas aus Kristallglas, seidenmatt	Tumbler holder, complete ■ wall version ■ crystal glass tumbler, frosted	A	B	C	D	E
			54,-	99,-	159,-	232,-	298,-
			F	G	H	I	L
			262,-	158,-	234,-	322,-	374,-

	732.00.336 Mundglas, seidenmatt, lose	Glass tumbler, frosted, separate	A				
			19,-				

	632.00.046 Glashalter, komplett ■ Standmodell ■ Glas aus Kristallglas, seidenmatt	Tumbler holder, complete ■ free standing version ■ crystal glass tumbler, frosted	A	B	C	D	E
			49,-	89,-	114,-	174,-	219,-
			F	G	H	I	L
			194,-	184,-	218,-	284,-	374,-

Accessoires für WC-Bereich | Accessories for w.c. area

	632.00.014 Papierhalter ■ beweglicher Bügel	Toilet paper roll holder ■ mobile bracket	A	B	C	D	E
			79,-	149,-	208,-	247,-	313,-
			F	G	H	I	L
			286,-	274,-	459,-	576,-	946,-

	632.00.015 Reserve-Papierhalter	Spare toilet paper roll holder	A	B	C	D	E
			39,-	78,-	119,-	138,-	182,-
			F	G	H	I	L
			159,-	132,-	246,-	318,-	489,-

Maßzeichnungen unter www.joerger.de - Menü SERVICE.
 Technical specifications under www.joerger.de - menu SERVICE.

A chrom chrome	[.000]	E platin matt platinum matt	[.066]
B silbernickel polished nickel	[.035]	F nerz matt milk matt	[.096]
C nerz milk	[.095]	G schwarz-matt black matt	[.092]
C nickel matt satin nickel	[.036]	H farbig coloured	[.xxx]
D edelmessing sunshine	[.040]	H bronze bronze	[.011]
D platin platinum	[.065]	I gold gold	[.020]
E edelmess.matt sunshine matt	[.041]	L roségold rosegold	[.022]
E gold matt gold matt	[.021]	L roségold matt rosegold matt	[.023]



632.00.000 Klosettbürstengarnitur, komplett <ul style="list-style-type: none"> wandhängendes Modell Glas aus Kristallglas, seidenmatt 	Toilet brush holder set, complete <ul style="list-style-type: none"> suspended model crystal glass, frosted 	A	B	C	D	E
		86,-	139,-	198,-	257,-	323,-
		F	G	H	I	L
		292,-	248,-	399,-	549,-	728,-

799.00.302 Bürstenglas, lose	Glass, separate	A				
		29,-				

799.00.237 Bürstenkopf, lose	Brush, separate	A				
		22,-				



632.00.001 Klosettbürstengarnitur, komplett <ul style="list-style-type: none"> stehendes Modell Bürstentopf aus Metall 	Toilet brush holder set, complete <ul style="list-style-type: none"> floor standing model brush holder out of brass 	A	B	C	D	E
		118,-	189,-	249,-	294,-	389,-
		F	G	H	I	L
		328,-	426,-	668,-	749,-	1.279,-

Spiegel | Mirrors



649.00.414 Kosmetikspiegel, beleuchtet <ul style="list-style-type: none"> schwenk- und ausziehbar 3-fache Vergrößerung Direktanschluss Spiegeldurchmesser 185 mm Rahmendurchmesser 250 mm Kalt-, Warm- und Taglicht durch Piezzo-Schalter umschaltbar 	Cosmetic mirror, incl. lighting <ul style="list-style-type: none"> swivelling and extendable magnification 3:1 direct connection mirror diameter 185 mm frame diameter 250 mm cold, warm and day light switchable by Piezzo switch 	A	B	C	D	E
		556,-	988,-	1.214,-	1.418,-	1.828,-
		F	G	H	I	L
		1.684,-	1.214,-	1.549,-	2.138,-	2.998,-





Oberflächen | colours

Folgende Oberflächen sind bei dieser Serie möglich |
The following colours are possible with this collection

chrom	chrome	[.000] PG A
silbernickel	polished nickel	[.035] PG B
nerz	mink	[.095] PG C
nickel matt	satin nickel	[.036] PG C
edelmessing	sunshine	[.040] PG D
platin	platinum	[.065] PG D
edelmessing matt	sunshine matt	[.041] PG E
gold matt	gold matt	[.021] PG E
platin matt	platinum matt	[.066] PG E
nerz matt	mink matt	[.096] PG F
schwarz matt	black matt	[.092] PG G
weiß matt	white matt	[.052] PG G
bronze	bronze	[.011] PG H
gold	gold	[.020] PG I
roségold	rosegold	[.022] PG L
roségold matt	rosegold matt	[.023] PG L
himmelblau	azure	[.079] PG H
apfelgrün	apple-green	[.063] PG H
lila	purple	[.084] PG H
rosa	pink	[.081] PG H
türkis	turquoise	[.076] PG H
orange	orange	[.093] PG H
gelb	yellow	[.091] PG H
rot	red	[.082] PG H

Andere Oberflächen auf Anfrage |
Different colours on request

Waschtisch | Washbasin

ab Seite | from page 020

Bidet | Bidet

ab Seite | from page 021

Wanne | Bath tub

ab Seite | from page 022

Dusche | Shower

ab Seite | from page 023

Accessoires | Accessories

ab Seite | from page 031

Auf Anfrage können wir Produkte von
Drittanbietern auch gerne passend zu unseren
Oberflächen veredeln (vorbehaltlich der
Eignungsprüfung) | Third-party products may be
plated matching to our colours on request
(subject to valuation of suitability)

Maßzeichnungen unter www.joerger.de - Menü SERVICE.
 Technical specifications under www.joerger.de - menu SERVICE.

A chrom chrome	[.000]	E platin matt platinum matt	[.066]
B silbernickel polished nickel	[.035]	F nerz matt mink matt	[.096]
C nerz mink	[.095]	G schwarz-matt black matt	[.092]
C nickel matt satin nickel	[.036]	H farbig coloured	[.xxx]
D edelmessing sunshine	[.040]	H bronze bronze	[.011]
D platin platinum	[.065]	I gold gold	[.020]
E edelmess.matt sunshine matt	[.041]	L roségold rosegold	[.022]
E gold matt gold matt	[.021]	L roségold matt rosegold matt	[.023]

Waschtisch Batterien | Washbasin mixer



- 633.10.333** Waschtisch 1-Hand Batterie
- Ausladung 136 mm; Höhe 128 mm
 - Luftsprudler M24 x 1, verstellbar
 - Kartusche mit ker. Scheiben
 - Exzenterstange und Exzenter-Ablaufgarnitur
 - 2 Druckschläuche
M8x1 x 3/8" x 450 mm

- Single lever washbasin mixer
- spout projection 136 mm; height 128 mm
 - aerator M24 x 1, adjustable
 - cartridge with ceramic discs
 - lift rod and pop-up waste
 - 2 pressure hoses
M8x1 x 3/8" x 450 mm

A	B	C	D	E
299,-	399,-	528,-	629,-	838,-
F	G	H	I	L
729,-	479,-	998,-	1.457,-	2.185,-

Variante | Alternative



- 633.10.334** Waschtisch 1-Hand Batterie
- ohne Exzenter-Ablaufgarnitur

- Single lever washbasin mixer
- without pop-up waste

A	B	C	D	E
249,-	332,-	429,-	526,-	698,-
F	G	H	I	L
608,-	449,-	864,-	1.214,-	1.689,-

Waschtisch Batterien XL | Washbasin mixer XL



- 633.10.335** Waschtisch 1-Hand Batterie
- Ausladung 173 mm; Höhe 188 mm
 - Luftsprudler M24 x 1, verstellbar
 - Kartusche mit ker. Scheiben
 - Exzenterstange und Exzenter-Ablaufgarnitur
 - 2 Druckschläuche
M8x1 x 3/8" x 450 mm

- Single lever washbasin mixer
- spout projection 173 mm; height 188 mm
 - aerator M24 x 1, adjustable
 - cartridge with ceramic discs
 - lift rod and pop-up waste
 - 2 pressure hoses
M8x1 x 3/8" x 450 mm

A	B	C	D	E
349,-	452,-	576,-	679,-	919,-
F	G	H	I	L
805,-	539,-	1.024,-	1.532,-	2.298,-

Variante | Alternative



- 633.10.336** Waschtisch 1-Hand Batterie
- ohne Exzenter-Ablaufgarnitur

- Single lever washbasin mixer
- without pop-up waste

A	B	C	D	E
289,-	374,-	485,-	556,-	762,-
F	G	H	I	L
668,-	510,-	896,-	1.269,-	1.796,-

Waschtisch Batterie XXL | Washbasin mixer XXL





- 633.10.332** Waschtisch 1-Hand Batterie
- Ausladung 194 mm; Höhe 268 mm
 - ohne Exzenter-Ablaufgarnitur
 - Luftsprudler M24 x 1, verstellbar
 - Kartusche mit ker. Scheiben
 - 2 Druckschläuche
M8x1 x 3/8" x 450 mm

- Single lever washbasin mixer
- spout projection 194 mm; height 268 mm
 - without pop-up waste
 - aerator M24 x 1, adjustable
 - cartridge with ceramic discs
 - 2 pressure hoses
M8x1 x 3/8" x 450 mm

A	B	C	D	E
349,-	524,-	714,-	795,-	1.159,-
F	G	H	I	L
1.006,-	698,-	984,-	1.358,-	1.809,-

A chrom chrome	[.000]	E platin matt platinum matt	[.066]
B silbernickel polished nickel	[.035]	F nerz matt milk matt	[.096]
C nerz milk	[.095]	G schwarz-matt black matt	[.092]
C nickel matt satin nickel	[.036]	H farbig coloured	[.xxx]
D edelmessing sunshine	[.040]	H bronze bronze	[.011]
D platin platinum	[.065]	I gold gold	[.020]
E edelmess.matt sunshine matt	[.041]	L roségold rosegold	[.022]
E gold matt gold matt	[.021]	L roségold matt rosegold matt	[.023]





Wand-Waschtisch 1-Hand Batterien | Single lever wall-washbasin mixer

	633.20.360 Wand-Waschtisch 1-Hand Batterie ½", Fertigmontageset <ul style="list-style-type: none"> ■ Ausladung 189 mm ■ Luftsprudler M24 ■ Wandrosetten 	Single lever wall washbasin mixer ½", assembly set <ul style="list-style-type: none"> ■ projection 189 mm ■ aerator M24 ■ escutcheons 	A	B	C	D	E	
				488,-	618,-	695,-	736,-	959,-
				F	G	H	I	L
			862,-	823,-	1.185,-	1.659,-	2.398,-	
Benötigt Required								
	649.20.362 Wand-Waschtisch 1-Hand Batterie ½", Einbaukörper <ul style="list-style-type: none"> ■ Bedienhebel rechts ■ zu Fertigmontageset 633.20.360 ■ Kartusche mit ker. Scheiben 	Single lever wall washbasin mixer ½", concealed body <ul style="list-style-type: none"> ■ control lever on the right ■ for assembly set 633.20.360 ■ cartridge with ceramic discs 	A					
			258,-					
	649.20.364 Wand-Waschtisch 1-Hand Batterie ½", Einbaukörper <ul style="list-style-type: none"> ■ Bedienhebel links ■ zu Fertigmontageset 633.20.360 ■ Kartusche mit ker. Scheiben 	Single lever wall washbasin mixer ½", concealed body <ul style="list-style-type: none"> ■ control lever on the left ■ for assembly set 633.20.360 ■ cartridge with ceramic discs 	A					
			258,-					

Bidet Batterie | Bidet mixer

	633.10.111 Bidet 1-Hand Batterie <ul style="list-style-type: none"> ■ Ausladung 160 mm; Höhe 128 mm ■ Luftsprudler M18,5 x 1 mit Kugelgelenk ■ Kartusche mit ker. Scheiben ■ Exzenterstange und Exzenter-Ablaufgarnitur ■ 2 Druckschläuche M8x1 x ¾" x 450 mm 	Single lever bidet mixer <ul style="list-style-type: none"> ■ spout projection 160 mm; height 128 mm ■ aerator M18,5 x 1 with ball joint ■ cartridge with ceramic discs ■ lift rod and pop-up waste ■ 2 pressure hoses M8x1 x ¾" x 450 mm 	A	B	C	D	E
			349,-	498,-	628,-	726,-	962,-
			F	G	H	I	L
		844,-	589,-	1.058,-	1.529,-	2.294,-	

Zubehör für Waschtisch- und Bidet-Batterien | Supplies for washbasin and bidet mixer

	632.12.100 Eckventil ½" <ul style="list-style-type: none"> ■ Ausladung 105 mm ■ Fettkammer-Innenoberteil ½" ■ Quetschverschraubung ■ Schubrosette 	Angle valve ½" <ul style="list-style-type: none"> ■ projection 105 mm ■ cartridge ½" ■ compression joint ■ escutcheon 	A	B	C	D	E
			99,-	122,-	163,-	173,-	223,-
			F	G	H	I	L
		197,-	184,-	365,-	465,-	610,-	
	649.15.340 Waschtisch-Tassensiphon 1 ¼" <ul style="list-style-type: none"> ■ schwere Ausführung ■ Rosette ■ Abgangsrohr ø 32 mm ■ Tauchrohrlänge 165 mm 	Washbasin cupped siphon trap 1 ¼" <ul style="list-style-type: none"> ■ heavy brass ■ escutcheon ■ outlet tube ø 32 mm ■ dip pipe 165 mm 	A	B	C	D	E
			195,-	296,-	368,-	429,-	568,-
			F	G	H	I	L
		498,-	378,-	539,-	686,-	832,-	
	649.15.270 Zwangsablaufventil <ul style="list-style-type: none"> ■ Schaftlänge 70 mm ■ für Waschbecken ohne Überlauf 	Restraint drain/waste <ul style="list-style-type: none"> ■ length of shaft 70 mm ■ for washbasins without overflow 	A	B	C	D	E
			68,-	129,-	185,-	239,-	312,-
			F	G	H	I	L
		299,-	176,-	394,-	429,-	582,-	
	649.15.271 Zwangsablaufventil <ul style="list-style-type: none"> ■ Schaftlänge 100 mm ■ für Waschbecken ohne Überlauf 	Restraint drain/waste <ul style="list-style-type: none"> ■ length of shaft 100 mm ■ for washbasins without overflow 	A	B	C	D	E
			72,-	138,-	196,-	254,-	329,-
			F	G	H	I	L
		318,-	186,-	418,-	454,-	616,-	

Maßzeichnungen unter www.joerger.de - Menü SERVICE.
 Technical specifications under www.joerger.de - menu SERVICE.

A	chrom chrome	[.000]	E	platin matt platinum matt	[.066]
B	silbernickel polished nickel	[.035]	F	nerz matt mink matt	[.096]
C	nerz mink	[.095]	G	schwarz-matt black matt	[.092]
C	nickel matt satin nickel	[.036]	H	farbig coloured	[.xxx]
D	edelmessing sunshine	[.040]	H	bronze bronze	[.011]
D	platin platinum	[.065]	I	gold gold	[.020]
E	edelmess.matt sunshine matt	[.041]	L	roségold rosegold	[.022]
E	gold matt gold matt	[.021]	L	roségold matt rosegold matt	[.023]

Badewanne, Aufputz-Batterien | Bath tub mixer sets, exposed

	633.20.500 Wannenfüll- und Brausebatterie für Aufputzmontage, mit Garnitur <ul style="list-style-type: none"> ■ Ausladung 192 mm ■ Kartusche mit ker. Scheiben ■ manuelle Umstellung Wanne/Brause ■ verdeckte S-Anschlüsse 1/2" x 3/4" ■ Handbrause mit 3 Strahlarten, Anti-Kalk-System und Rückflussverhinderer ■ Metall-Brauseschlauch 1500 mm, beidseitig mit drehbarem Konus 	Exposed tub/shower mixer 1/2", incl. shower set <ul style="list-style-type: none"> ■ spout projection 192 mm ■ cartridge with ceramic discs ■ manual tub/shower diverter ■ concealed S-connections 1/2" x 3/4" ■ hand shower with 3 jets, anticalc. system and backflow preventer ■ metal shower hose 1500 mm, both sides with turning cone 	A	B	C	D	E
			569,-	1.099,-	1.554,-	1.796,-	2.525,-
			F	G	H	I	L
			2.196,-	1.129,-	2.185,-	2.925,-	3.189,-

Achtung! Dieser Artikel kann nicht in farbig geliefert werden.
Attention! This item can not be delivered in coloured.

	633.20.505 Wannenfüll- und Brausebatterie für Aufputzmontage, mit Garnitur <ul style="list-style-type: none"> ■ Ausladung 192 mm ■ Kartusche mit ker. Scheiben ■ manuelle Umstellung Wanne/Brause ■ verdeckte S-Anschlüsse 1/2" x 3/4" ■ Handbrause aus Metall mit einer Strahlart, Anti-Kalk-System und Rückflussverhinderer ■ Metall-Brauseschlauch 1500 mm, beidseitig mit drehbarem Konus 	Exposed tub/shower mixer 1/2", incl. shower set <ul style="list-style-type: none"> ■ spout projection 192 mm ■ cartridge with ceramic discs ■ manual tub/shower diverter ■ concealed S-connections 1/2" x 3/4" ■ metal hand shower with 1 jet, anticalc. system and backflow preventer ■ metal shower hose 1500 mm, both sides with turning cone 	A	B	C	D	E
			699,-	1.329,-	1.646,-	1.866,-	2.595,-
			F	G	H	I	L
			2.266,-	1.236,-	2.279,-	2.995,-	3.159,-

	633.20.510 Wannenfüll- und Brausebatterie für Aufputzmontage, ohne Garnitur <ul style="list-style-type: none"> ■ Ausladung 192 mm ■ Kartusche mit ker. Scheiben ■ manuelle Umstellung Wanne/Brause ■ verdeckte S-Anschlüsse 1/2" x 3/4" 	Exposed tub/shower mixer 1/2", without shower set <ul style="list-style-type: none"> ■ spout projection 192 mm ■ cartridge with ceramic discs ■ manual tub/shower diverter ■ concealed S-connections 1/2" x 3/4" 	A	B	C	D	E
			495,-	956,-	1.264,-	1.475,-	2.197,-
			F	G	H	I	L
			1.910,-	982,-	1.938,-	2.458,-	2.686,-

	633.20.540 Wannenfüll- und Brausebatterie für Standrohrmontage, mit Garnitur <ul style="list-style-type: none"> ■ Ausladung mit Standrohren 232 mm ■ Kartusche mit ker. Scheiben ■ manuelle Umstellung Wanne/Brause ■ Handbrause mit 3 Strahlarten, Anti-Kalk-System und Rückflussverhinderer ■ Metall-Brauseschlauch 1500 mm, beidseitig mit drehbarem Konus 	Tub/shower mixer for supply pipes, incl. shower set <ul style="list-style-type: none"> ■ spout projection with pipes 232 mm ■ cartridge with ceramic discs ■ manual tub/shower diverter ■ hand shower with 3 jets, anticalc. system and backflow preventer ■ metal shower hose 1500 mm, both sides with turning cone 	A	B	C	D	E
			539,-	1.069,-	1.476,-	1.739,-	2.415,-
			F	G	H	I	L
			2.139,-	1.069,-	2.129,-	2.716,-	2.929,-

Achtung! Dieser Artikel kann nicht in farbig geliefert werden.
Attention! This item can not be delivered in coloured.

Benötigt | Required

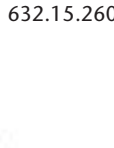
	632.15.260 Wasserzufuhrstandrohre 1/2" <ul style="list-style-type: none"> ■ 2 Stück, in Boden einzuschrauben ■ inkl. Winkelstück zum Anschluß der Wannenfüll- und Brausebatterie ■ Höhe 785 - 810 mm 	Water supply pipes 1/2" <ul style="list-style-type: none"> ■ 2 pieces, floor installation ■ incl. angle for connecting tub/shower mixer ■ height 785 - 810 mm 	A	B	C	D	E
			659,-	889,-	1.079,-	1.224,-	1.432,-
			F	G	H	I	L
			1.328,-	1.309,-	1.759,-	2.349,-	3.338,-

Empfohlen | Recommended

	109.10.970 Bausatz-Vormontage <ul style="list-style-type: none"> ■ Bodenplatte mit Befestigungsset ■ für Wasserzufuhrstandrohre 632.15.260 	Assembly set for pre-installation <ul style="list-style-type: none"> ■ joint plate with fixing set ■ for water supply pipes 632.15.260 	A				
			459,-				

A chrom chrome	[.000]	E platin matt platinum matt	[.066]
B silbernickel polished nickel	[.035]	F nerz matt milk matt	[.096]
C nerz milk	[.095]	G schwarz-matt black matt	[.092]
C nickel matt satin nickel	[.036]	H farbig coloured	[.xxx]
D edelmessing sunshine	[.040]	H bronze bronze	[.011]
D platin platinum	[.065]	I gold gold	[.020]
E edelmess.matt sunshine matt	[.041]	L roségold rosegold	[.022]
E gold matt gold matt	[.021]	L roségold matt rosegold matt	[.023]

	633.20.545 Wannenfüll- und Brausebatterie für Standrohrmontage, mit Garnitur <ul style="list-style-type: none"> ■ Ausladung mit Standrohren 232 mm ■ Kartusche mit ker. Scheiben ■ manuelle Umstellung Wanne/Brause ■ Handbrause aus Metall mit einer Strahlart, Anti-Kalk-System und Rückflussverhinderer ■ Metall-Brauseschlauch 1500 mm, beidseitig mit drehbarem Konus 	Tub/shower mixer for supply pipes, incl. shower set <ul style="list-style-type: none"> ■ spout projection with pipes 232 mm ■ cartridge with ceramic discs ■ manual tub/shower diverter ■ metal hand shower with 1 jet, anticalc. system and backflow preventer ■ metal shower hose 1500 mm, both sides with turning cone 	<table border="1"> <tr><th>A</th><th>B</th><th>C</th><th>D</th><th>E</th></tr> <tr><td>669,-</td><td>1.222,-</td><td>1.568,-</td><td>1.809,-</td><td>2.485,-</td></tr> <tr><th>F</th><th>G</th><th>H</th><th>I</th><th>L</th></tr> <tr><td>2.209,-</td><td>1.176,-</td><td>2.124,-</td><td>2.789,-</td><td>2.999,-</td></tr> </table>	A	B	C	D	E	669,-	1.222,-	1.568,-	1.809,-	2.485,-	F	G	H	I	L	2.209,-	1.176,-	2.124,-	2.789,-	2.999,-
	A	B	C	D	E																		
	669,-	1.222,-	1.568,-	1.809,-	2.485,-																		
F	G	H	I	L																			
2.209,-	1.176,-	2.124,-	2.789,-	2.999,-																			
Benötigt Required	632.15.260 Wasserzufuhrstandrohre 1/2" <ul style="list-style-type: none"> ■ 2 Stück, in Boden einzuschrauben ■ inkl. Winkelstück zum Anschluß der Wannenfüll- und Brausebatterie ■ Höhe 785 - 810 mm 	Water supply pipes 1/2" <ul style="list-style-type: none"> ■ 2 pieces, floor installation ■ incl. angle for connecting tub/shower mixer ■ height 775 - 800 mm 	<table border="1"> <tr><th>A</th><th>B</th><th>C</th><th>D</th><th>E</th></tr> <tr><td>659,-</td><td>889,-</td><td>1.079,-</td><td>1.224,-</td><td>1.432,-</td></tr> <tr><th>F</th><th>G</th><th>H</th><th>I</th><th>L</th></tr> <tr><td>1.328,-</td><td>1.309,-</td><td>1.759,-</td><td>2.349,-</td><td>3.338,-</td></tr> </table>	A	B	C	D	E	659,-	889,-	1.079,-	1.224,-	1.432,-	F	G	H	I	L	1.328,-	1.309,-	1.759,-	2.349,-	3.338,-
A	B	C	D	E																			
659,-	889,-	1.079,-	1.224,-	1.432,-																			
F	G	H	I	L																			
1.328,-	1.309,-	1.759,-	2.349,-	3.338,-																			
Empfohlen Recommended	109.10.970 Bausatz-Vormontage <ul style="list-style-type: none"> ■ Bodenplatte mit Befestigungsset ■ für Wasserzufuhrstandrohre 633.15.260 	Assembly set for pre-installation <ul style="list-style-type: none"> ■ joint plate with fixing set ■ for water supply pipes 633.15.260 	<table border="1"> <tr><th>A</th><th>B</th><th>C</th><th>D</th><th>E</th></tr> <tr><td>459,-</td><td></td><td></td><td></td><td></td></tr> </table>	A	B	C	D	E	459,-														
A	B	C	D	E																			
459,-																							

Dusche, Aufputz-Batterien | Shower mixer sets, exposed

	633.20.600 1-Hand Brausebatterie 1/2" für Aufputzmontage <ul style="list-style-type: none"> ■ Kartusche mit keramischen Scheiben ■ Brauseabgang 1/2" ■ verdeckte S-Anschlüsse 1/2" x 3/4" 	Single lever exposed shower mixer 1/2" <ul style="list-style-type: none"> ■ cartridge with ceramic discs ■ discharge 1/2" ■ concealed S-connections 1/2" x 3/4" 	<table border="1"> <tr><th>A</th><th>B</th><th>C</th><th>D</th><th>E</th></tr> <tr><td>386,-</td><td>646,-</td><td>829,-</td><td>914,-</td><td>1.284,-</td></tr> <tr><th>F</th><th>G</th><th>H</th><th>I</th><th>L</th></tr> <tr><td>1.126,-</td><td>824,-</td><td>1.139,-</td><td>1.648,-</td><td>2.239,-</td></tr> </table>	A	B	C	D	E	386,-	646,-	829,-	914,-	1.284,-	F	G	H	I	L	1.126,-	824,-	1.139,-	1.648,-	2.239,-
	A	B	C	D	E																		
	386,-	646,-	829,-	914,-	1.284,-																		
F	G	H	I	L																			
1.126,-	824,-	1.139,-	1.648,-	2.239,-																			

633.20.660 – Aufputz Set mit Steigrohr | Exposed set with shower system

	649.13.885 Regenbrause 1/2", ø 250 mm <ul style="list-style-type: none"> ■ Ausführung ganz in Metall ■ mit Kugelgelenk ■ Anti-Kalk-System 	Rain shower head 1/2", ø 250 mm <ul style="list-style-type: none"> ■ full metal body ■ with ball joint ■ with anticalcareous system 	<table border="1"> <tr><th>A</th><th>B</th><th>C</th><th>D</th><th>E</th></tr> <tr><td>168,-</td><td>359,-</td><td>618,-</td><td>708,-</td><td>1.049,-</td></tr> <tr><th>F</th><th>G</th><th>H</th><th>I</th><th>L</th></tr> <tr><td>899,-</td><td>589,-</td><td>968,-</td><td>1.599,-</td><td>2.196,-</td></tr> </table>	A	B	C	D	E	168,-	359,-	618,-	708,-	1.049,-	F	G	H	I	L	899,-	589,-	968,-	1.599,-	2.196,-
	A	B	C	D	E																		
	168,-	359,-	618,-	708,-	1.049,-																		
F	G	H	I	L																			
899,-	589,-	968,-	1.599,-	2.196,-																			
649.20.260 Steigrohr, Umstellung, Wandarm <ul style="list-style-type: none"> ■ zum Anschluß an die Brausebatterie ■ Ausladung 390 - 410 mm ■ in der Neigung und Höhe verstellbare Brausehalterung 	Supply pipe, diverter, wall bracket <ul style="list-style-type: none"> ■ to connect the exposed shower mixer ■ projection 390 - 410 mm ■ fitting for handshower adjustable in height and inclination 	<table border="1"> <tr><th>A</th><th>B</th><th>C</th><th>D</th><th>E</th></tr> <tr><td>398,-</td><td>669,-</td><td>838,-</td><td>996,-</td><td>1.276,-</td></tr> <tr><th>F</th><th>G</th><th>H</th><th>I</th><th>L</th></tr> <tr><td>1.122,-</td><td>1.182,-</td><td>1.520,-</td><td>1.736,-</td><td>2.399,-</td></tr> </table>	A	B	C	D	E	398,-	669,-	838,-	996,-	1.276,-	F	G	H	I	L	1.122,-	1.182,-	1.520,-	1.736,-	2.399,-	
A	B	C	D	E																			
398,-	669,-	838,-	996,-	1.276,-																			
F	G	H	I	L																			
1.122,-	1.182,-	1.520,-	1.736,-	2.399,-																			
632.13.700 Brausegarnitur <ul style="list-style-type: none"> ■ Handbrause mit 3 Strahlarten, Anti-Kalk-System und Rückflussverhinderer ■ Metall-Brauseschlauch 1500 mm, beidseitig mit drehbarem Konus 	Shower combination <ul style="list-style-type: none"> ■ hand shower with 3 jets, anticalc. system and backflow preventer ■ metal shower hose 1500 mm, both sides with turning cone 	<table border="1"> <tr><th>A</th><th>B</th><th>C</th><th>D</th><th>E</th></tr> <tr><td>139,-</td><td>268,-</td><td>418,-</td><td>479,-</td><td>739,-</td></tr> <tr><th>F</th><th>G</th><th>H</th><th>I</th><th>L</th></tr> <tr><td>632,-</td><td>492,-</td><td>798,-</td><td>954,-</td><td>1.282,-</td></tr> </table>	A	B	C	D	E	139,-	268,-	418,-	479,-	739,-	F	G	H	I	L	632,-	492,-	798,-	954,-	1.282,-	
A	B	C	D	E																			
139,-	268,-	418,-	479,-	739,-																			
F	G	H	I	L																			
632,-	492,-	798,-	954,-	1.282,-																			
<p>Achtung! Dieser Artikel kann nicht in farbig geliefert werden. Attention! This item can not be delivered in coloured.</p>																							
633.20.610 Aufputz-Brausebatterie 1/2" <ul style="list-style-type: none"> ■ für Steigrohr ■ Hebelmischer- und Umstellkartusche mit keramischen Scheiben ■ verdeckte S-Anschlüsse 1/2" x 3/4" 	Exposed shower mixer 1/2" <ul style="list-style-type: none"> ■ for supply pipe ■ single lever and diverter cartridge with ceramic discs ■ concealed S-connections 1/2" x 3/4" 	<table border="1"> <tr><th>A</th><th>B</th><th>C</th><th>D</th><th>E</th></tr> <tr><td>396,-</td><td>754,-</td><td>982,-</td><td>1.076,-</td><td>1.684,-</td></tr> <tr><th>F</th><th>G</th><th>H</th><th>I</th><th>L</th></tr> <tr><td>1.396,-</td><td>849,-</td><td>1.309,-</td><td>1.874,-</td><td>2.348,-</td></tr> </table>	A	B	C	D	E	396,-	754,-	982,-	1.076,-	1.684,-	F	G	H	I	L	1.396,-	849,-	1.309,-	1.874,-	2.348,-	
A	B	C	D	E																			
396,-	754,-	982,-	1.076,-	1.684,-																			
F	G	H	I	L																			
1.396,-	849,-	1.309,-	1.874,-	2.348,-																			

Maßzeichnungen unter www.joerger.de - Menü SERVICE.
 Technical specifications under www.joerger.de - menu SERVICE.

A chrom chrome	[.000]	E platin matt platinum matt	[.066]
B silbernickel polished nickel	[.035]	F nerz matt mink matt	[.096]
C nerz mink	[.095]	G schwarz-matt black matt	[.092]
C nickel matt satin nickel	[.036]	H farbig coloured	[.xxx]
D edelmessing sunshine	[.040]	H bronze bronze	[.011]
D platin platinum	[.065]	I gold gold	[.020]
E edelmess.matt sunshine matt	[.041]	L roségold rosegold	[.022]
E gold matt gold matt	[.021]	L roségold matt rosegold matt	[.023]

633.20.665 – Aufputz Set mit Steigrohr | Exposed set with shower system



649.13.885 Regenbrause ½", ø 250 mm <ul style="list-style-type: none"> ■ Ausführung ganz in Metall ■ mit Kugelgelenk ■ Anti-Kalk-System 	Rain shower head ½", ø 250 mm <ul style="list-style-type: none"> ■ full metal body ■ with ball joint ■ with anticalcareous system 	A	B	C	D	E
		168,-	359,-	618,-	708,-	1.049,-
649.20.260 Steigrohr, Umstellung, Wandarm <ul style="list-style-type: none"> ■ zum Anschluß an die Brausebatterie ■ Ausladung 390 - 410 mm ■ in der Neigung und Höhe verstellbare Brausehalterung 	Supply pipe, diverter, wall bracket <ul style="list-style-type: none"> ■ to connect the exposed shower mixer ■ projection 390 - 410 mm ■ fitting for handshower adjustable in height and inclination 	F	G	H	I	L
		899,-	589,-	968,-	1.599,-	2.196,-
632.13.705 Brausegarnitur <ul style="list-style-type: none"> ■ Handbrause aus Metall mit einer Strahlart, Anti-Kalk-System und Rückflussverhinderer ■ Metall-Brauseschlauch 1500 mm, beidseitig mit drehbarem Konus 	Shower combination <ul style="list-style-type: none"> ■ metal hand shower with 1 jet, anticalc. system and backflow preventer ■ metal shower hose 1500 mm, both sides with turning cone 	A	B	C	D	E
		279,-	499,-	546,-	648,-	796,-
633.20.610 Aufputz-Brausebatterie ½" <ul style="list-style-type: none"> ■ für Steigrohr ■ Hebelmischer- und Umstellkartusche mit keramischen Scheiben ■ verdeckte S-Anschlüsse ½" x ¾" 	Exposed shower mixer ½" <ul style="list-style-type: none"> ■ for supply pipe ■ single lever and diverter cartridge with ceramic discs ■ concealed S-connections ½" x ¾" 	F	G	H	I	L
		784,-	598,-	896,-	1.138,-	1.379,-
		A	B	C	D	E
		396,-	754,-	982,-	1.076,-	1.684,-
		F	G	H	I	L
		1.396,-	849,-	1.309,-	1.874,-	2.348,-

632.20.460 – Aufputz Thermostat-Set mit Steigrohr | Exposed thermostat-set with shower system



649.13.885 Regenbrause ½", ø 250 mm <ul style="list-style-type: none"> ■ Ausführung ganz in Metall ■ mit Kugelgelenk ■ Anti-Kalk-System 	Rain shower head ½", ø 250 mm <ul style="list-style-type: none"> ■ full metal body ■ with ball joint ■ with anticalcareous system 	A	B	C	D	E
		168,-	359,-	618,-	708,-	1.049,-
649.20.260 Steigrohr, Umstellung, Wandarm <ul style="list-style-type: none"> ■ zum Anschluß an die Brausebatterie ■ Ausladung 390 - 410 mm ■ in der Neigung und Höhe verstellbare Brausehalterung 	Supply pipe, diverter, wall bracket <ul style="list-style-type: none"> ■ to connect the exposed shower mixer ■ projection 390 - 410 mm ■ fitting for handshower adjustable in height and inclination 	F	G	H	I	L
		899,-	589,-	968,-	1.599,-	2.196,-
632.13.700 Brausegarnitur <ul style="list-style-type: none"> ■ Handbrause mit 3 Strahlarten, Anti-Kalk-System und Rückflussverhinderer ■ Metall-Brauseschlauch 1500 mm, beidseitig mit drehbarem Konus 	Shower combination <ul style="list-style-type: none"> ■ hand shower with 3 jets, anticalc. system and backflow preventer ■ metal shower hose 1500 mm, both sides with turning cone 	A	B	C	D	E
		139,-	268,-	418,-	479,-	739,-
632.20.260 Brausethermostat ½" für Steigrohr-Montage <ul style="list-style-type: none"> ■ Dehnstoff-Thermoelement ■ Sicherheitssperre bei 38° C ■ Umstellkartusche mit keramischen Scheiben; Brauseabgang ½" ■ verdeckte S-Anschlüsse ½" x ¾" 	Exposed shower thermostat ½" for supply pipe <ul style="list-style-type: none"> ■ cartridge with thermoelement ■ locking device at 38° C ■ diverter cartridge with ceramic discs; discharge ½" ■ concealed S-connections ½" x ¾" 	F	G	H	I	L
		632,-	492,-	798,-	954,-	1.282,-
		A	B	C	D	E
		479,-	788,-	1.012,-	1.209,-	1.749,-
		F	G	H	I	L
		1.464,-	936,-	1.557,-	2.079,-	2.719,-

Achtung! Dieser Artikel kann nicht in farbig geliefert werden.
Attention! This item can not be delivered in coloured.

A chrom chrome	[.000]	E platin matt platinum matt	[.066]
B silbernickel polished nickel	[.035]	F nerz matt milk matt	[.096]
C nerz milk	[.095]	G schwarz-matt black matt	[.092]
C nickel matt satin nickel	[.036]	H farbig coloured	[.xxx]
D edelmessing sunshine	[.040]	H bronze bronze	[.011]
D platin platinum	[.065]	I gold gold	[.020]
E edelmess.matt sunshine matt	[.041]	L roségold rosegold	[.022]
E gold matt gold matt	[.021]	L roségold matt rosegold matt	[.023]

632.20.465 – Aufputz Thermostat-Set mit Steigrohr | Exposed thermostat-set with shower system



		A	B	C	D	E
649.13.885 Regenbrause ½", ø 250 mm <ul style="list-style-type: none"> ■ Ausführung ganz in Metall ■ mit Kugelgelenk ■ Anti-Kalk-System 	Rain shower head ½", ø 250 mm <ul style="list-style-type: none"> ■ full metal body ■ with ball joint ■ with anticalcareous system 	168,-	359,-	618,-	708,-	1.049,-
		F	G	H	I	L
		899,-	589,-	968,-	1.599,-	2.196,-
649.20.260 Steigrohr, Umstellung, Wandarm <ul style="list-style-type: none"> ■ zum Anschluß an die Brausebatterie ■ Ausladung 390 - 410 mm ■ in der Neigung und Höhe verstellbare Brausehalterung 	Supply pipe, diverter, wall bracket <ul style="list-style-type: none"> ■ to connect the exposed shower mixer ■ projection 390 - 410 mm ■ fitting for handshower adjustable in height and inclination 	398,-	669,-	838,-	996,-	1.276,-
		F	G	H	I	L
		1.122,-	1.182,-	1.520,-	1.736,-	2.399,-
632.13.705 Brausegarnitur <ul style="list-style-type: none"> ■ Handbrause aus Metall mit einer Strahlart, Anti-Kalk-System und Rückflussverhinderer ■ Metall-Brauseschlauch 1500 mm, beidseitig mit drehbarem Konus 	Shower combination <ul style="list-style-type: none"> ■ metal hand shower with 1 jet, anticalc. system and backflow preventer ■ metal shower hose 1500 mm, both sides with turning cone 	279,-	499,-	546,-	648,-	796,-
		F	G	H	I	L
		784,-	598,-	896,-	1.138,-	1.379,-
632.20.260 Brausethermostat ½" für Steigrohr-Montage <ul style="list-style-type: none"> ■ Dehnstoff-Thermoelement ■ Sicherheitssperre bei 38° C ■ Umstellkartusche mit keramischen Scheiben; Brauseabgang ½" ■ verdeckte S-Anschlüsse ½" x ¾" 	Exposed shower thermostat ½" for supply pipe <ul style="list-style-type: none"> ■ cartridge with thermoelement ■ locking device at 38° C ■ diverter cartridge with ceramic discs; discharge ½" ■ concealed S-connections ½" x ¾" 	479,-	788,-	1.012,-	1.209,-	1.749,-
		F	G	H	I	L
		1.464,-	936,-	1.557,-	2.079,-	2.719,-

Unterputz-Hebelmischer ½" | Concealed single lever mixer ½"



		A	B	C	D	E
633.20.125 1-Hand Wannenfüll- und Brausebatterie ½" für UP-Montage, Fertigmontageset <ul style="list-style-type: none"> ■ manuelle, keramische Umstellung für druckunabhängige Funktion ■ mit Sicherheitseinrichtung ■ Durchflußrate 21 l/min bei 3 bar 	Concealed single lever wall tub and shower mixer ½", assembly set <ul style="list-style-type: none"> ■ manual, ceramic diverter tub/shower for pressure-independent function ■ with safety device ■ flow rate 21 l/min at 3 bar 	599,-	1.018,-	1.084,-	1.144,-	1.378,-
		F	G	H	I	L
		1.266,-	949,-	1.326,-	1.552,-	1.899,-

Variante | Alternative



		A	B	C	D	E
633.20.135 1-Hand Wannenfüll- und Brausebatterie ½" für UP-Montage, Fertigmontageset <ul style="list-style-type: none"> ■ manuelle, keramische Umstellung für druckunabhängige Funktion ■ ohne Sicherheitseinrichtung ■ Durchflußrate 21 l/min bei 3 bar 	Concealed single lever wall tub and shower mixer ½", assembly set <ul style="list-style-type: none"> ■ manual, ceramic diverter tub/shower for pressure-independent function ■ without safety device ■ flow rate 21 l/min at 3 bar 	499,-	948,-	1.016,-	1.084,-	1.356,-
		F	G	H	I	L
		1.234,-	919,-	1.226,-	1.452,-	1.799,-

Variante | Alternative



		A	B	C	D	E
633.20.245 1-Hand Brausebatterie ½" für UP-Montage, Fertigmontageset <ul style="list-style-type: none"> ■ ohne Umstellung ■ Funktionseinheit mit ker. Scheiben ■ Durchflußrate 20,4 l/min bei 3 bar 	Concealed single lever shower mixer ½", assembly set <ul style="list-style-type: none"> ■ without diverter ■ functional unit with ceramic discs ■ flow rate 20,4 l/min at 3 bar 	429,-	848,-	914,-	974,-	1.208,-
		F	G	H	I	L
		1.096,-	719,-	1.156,-	1.382,-	1.729,-

Benötigt | Required



		A	B	C	D	E
649.40.360 Unterputz-Einbaubox ½" <ul style="list-style-type: none"> ■ zu Fertigmontageset 633.20.125, 633.20.135 und 633.20.245 ■ für Nass- und Trockenbau geeignet 	Concealed wall box ½" <ul style="list-style-type: none"> ■ for assembly set 633.20.125, 633.20.135 and 633.20.245 ■ for wetwall and drywall construction 	168,-				

Maßzeichnungen unter www.joerger.de - Menü SERVICE.
 Technical specifications under www.joerger.de - menu SERVICE.

A chrom chrome	[.000]	E platin matt platinum matt	[.066]
B silbernickel polished nickel	[.035]	F nerz matt milk matt	[.096]
C nerz milk	[.095]	G schwarz-matt black matt	[.092]
C nickel matt satin nickel	[.036]	H farbig coloured	[.xxx]
D edelmessing sunshine	[.040]	H bronze bronze	[.011]
D platin platinum	[.065]	I gold gold	[.020]
E edelmess.matt sunshine matt	[.041]	L roségold rosegold	[.022]
E gold matt gold matt	[.021]	L roségold matt rosegold matt	[.023]

Unterputz-Thermostate 1/2" | Wall thermostats, concealed 1/2"



632.40.380 Unterputz-Thermostat 1/2"
mit Mengenregulierung,
 Fertigmontageset

- manuelle, keramische Umstellung Wanne/Brause, druckunabhängig
- mit Sicherheitseinrichtung
- Durchflussrate 20,4 l/min bei 3 bar

Concealed wall thermostat 1/2"
with flow control,
 assembly set

- manual, ceramic diverter tub/shower for pressure-independent function
- with safety device
- flow rate 20,4 l/min at 3 bar

A	B	C	D	E
1.074,-	1.192,-	1.245,-	1.398,-	1.684,-
F	G	H	I	L
1.516,-	1.269,-	1.499,-	1.982,-	2.328,-

Variante | Alternative



632.40.360 Unterputz-Thermostat 1/2"
mit Mengenregulierung,
 Fertigmontageset

- ohne Umstellung
- mit integrierter keramischer Mengenregulierung
- Durchflussrate 20,4 l/min bei 3 bar

Concealed wall thermostat 1/2"
with flow control,
 assembly set

- without diverter
- with integrated ceramic cartridge for volume control
- flow rate 20,4 l/min at 3 bar

A	B	C	D	E
1.049,-	1.178,-	1.230,-	1.382,-	1.654,-
F	G	H	I	L
1.489,-	1.254,-	1.484,-	1.946,-	2.332,-

Variante | Alternative



615.40.460 Unterputz-Thermostat 1/2"
ohne Mengenregulierung,
 Fertigmontageset

- Funktionseinheit ohne Umstellung und ohne Absperrung
- Durchflussrate 25,8 l/min bei 3 bar

Concealed wall thermostat 1/2"
without flow control,
 assembly set

- Functional unit without diverter and without shut-off
- flow rate 25,8 l/min at 3 bar

A	B	C	D	E
898,-	1.028,-	1.192,-	1.226,-	1.486,-
F	G	H	I	L
1.368,-	1.192,-	1.434,-	1.679,-	2.153,-

Benötigt | Required



649.40.360 Unterputz-Einbaubox 1/2"

- zu Fertigmontageset 632.40.380, 632.40.360 und 615.40.460
- für Nass- und Trockenbau geeignet

Concealed wall box 1/2"

- for assembly set 632.40.380, 632.40.360 and 615.40.460
- for wetwall and drywall construction

A	B	C	D	E
168,-				

Unterputz-Thermostat 3/4" mit hohem Durchfluß | Wall thermostat, concealed 3/4" with high flow



615.40.555 Unterputz-Thermostat 3/4"
ohne Mengenregulierung,
 Fertigmontageset

- serienbezogener Temperiergriff
- Sicherheitssperre bei 38° C

Concealed wall thermostat 3/4"
without flow control,
 assembly set

- design handle for temp. control
- locking device at 38°C

A	B	C	D	E
586,-	686,-	748,-	795,-	1.064,-
F	G	H	I	L
952,-	626,-	779,-	1.239,-	1.858,-

Benötigt | Required



649.40.555 Unterputz-Einbaukörper 3/4"

- zu Fertigmontageset 615.40.555
- Kartusche mit Schmutzfangsieben
- für Nass- und Trockenbau geeignet
- Durchflussrate 64,2 l/min bei 3 bar
- ohne Absperrung

Concealed thermostat body 3/4"

- for assembly set 615.40.555
- cartridge with filter screens
- for wetwall and drywall construction
- flow rate 64,2 l/min at 3 bar
- without shut-off

A	B	C	D	E
1.636,-				

Unterputz-Thermostat 3/4" | Wall thermostat, concealed 3/4"



615.40.520 Unterputz-Thermostat 3/4"
ohne Mengenregulierung,
 Fertigmontageset

- serienbezogener Temperiergriff
- Sicherheitssperre bei 38° C

Concealed wall thermostat 3/4"
without flow control,
 assembly set

- design handle for temp. control
- locking device at 38°C

A	B	C	D	E
586,-	686,-	748,-	795,-	1.064,-
F	G	H	I	L
952,-	626,-	779,-	1.239,-	1.858,-

Benötigt | Required



649.40.520 Unterputz-Einbaukörper 3/4"

- zu Fertigmontageset 615.40.520
- Kartusche mit Schmutzfangsieben
- für Nass- und Trockenbau geeignet
- Durchflussrate 41 l/min bei 3 bar
- ohne Absperrung











Concealed thermostat body 3/4"

- for assembly set 615.40.520
- cartridge with filter screens
- for wetwall and drywall construction
- flow rate 41 l/min at 3 bar
- without shut-off

A	B	C	D	E
498,-				

A chrom chrome	[.000]	E platin matt platinum matt	[.066]
B silbernickel polished nickel	[.035]	F nerz matt milk matt	[.096]
C nerz milk	[.095]	G schwarz-matt black matt	[.092]
C nickel matt satin nickel	[.036]	H farbig coloured	[.xxx]
D edelmessing sunshine	[.040]	H bronze bronze	[.011]
D platin platinum	[.065]	I gold gold	[.020]
E edelmess.matt sunshine matt	[.041]	L roségold rosegold	[.022]
E gold matt gold matt	[.021]	L roségold matt rosegold matt	[.023]





Unterputz-Thermostat/Ventil-Modul | Concealed thermostatic/wall-valve modul

		A	B	C	D	E
	632.60.432 Unterputz-Ventil-Modul Fertigmontageset ■ Griff ■ Rosette	Concealed wall-valve-modul assembly set ■ design handle ■ escutcheon		209,-	258,-	284,-
			339,-	338,-	432,-	489,-
			632,-			
Benötigt Required						
	649.20.610 Unterputz-Ventil-Modul, 1-fach ■ 1x Spindelventil 3/4", rechts-schließend mit keram. Scheiben ■ 2 Abgänge 1/2", je 1x rechts/links möglich, gleichzeitig benutzbar	Concealed wall-valve-modul, single ■ 1x spindle valve 3/4", clockwise closure with ceramic discs ■ 2 outlets 1/2", each 1x right/left possible, simultaneously usable		229,-		
	649.20.620 Unterputz-Ventil-Modul, 2-fach ■ 2x Spindelventil 3/4", rechts-schließend mit keram. Scheiben ■ 4 Abgänge 1/2", je 2x rechts/links möglich, gleichzeitig benutzbar ■ im Verbund maßgenaue Montage ■ erweiterbar mit 649.20.610	Concealed wall-valve-modul, double ■ 2x spindle valve 3/4", clockwise closure with ceramic discs ■ 4 outlets 1/2", each 2x right/left possible, simultaneously usable ■ precise assembly due to composite ■ expandable with 649.20.610		458,-		
	649.20.630 Unterputz-Ventil-Modul, 3-fach ■ 3x Spindelventil 3/4", rechts-schließend mit keram. Scheiben ■ 6 Abgänge 1/2", je 3x rechts/links möglich, gleichzeitig benutzbar ■ im Verbund maßgenauen Montage ■ erweiterbar mit 649.20.610	Concealed wall-valve-modul, triple ■ 3x spindle valve 3/4", clockwise closure with ceramic discs ■ 6 outlets 1/2", each 3x right/left possible, simultaneously usable ■ precise assembly due to composite ■ expandable with 649.20.610		686,-		
	615.40.460 Unterputz-Thermostat 1/2" <u>ohne</u> Mengenregulierung, Fertigmontageset ■ Funktionseinheit <u>ohne</u> Umstellung und <u>ohne</u> Absperrung ■ Durchflussrate 25,8 l/min bei 3 bar	Concealed wall thermostat 1/2" <u>without</u> flow control, assembly set ■ Functional unit <u>without</u> diverter and <u>without</u> shut-off ■ flow rate 25,8 l/min at 3 bar		898,-	1.028,-	1.192,-
			1.368,-	1.192,-	1.434,-	1.679,-
			2.153,-			
Benötigt Required						
	649.20.612 Anschlußadapter 1/2" ■ Anschlußadapter, Abschlußstopfen ■ passend zu Einbaubox 649.40.360	Connection adapter 1/2" ■ connection adapter, end plug ■ matching to wall box 649.40.360		122,-		
	649.40.360 Unterputz-Einbaubox 1/2" ■ zu Fertigmontageset 615.40.460 ■ für Nass- und Trockenbau geeignet	Concealed wall box 1/2" ■ for assembly set 615.40.460 ■ for wetwall and drywall construction		168,-		
	615.40.555 Unterputz-Thermostat 3/4" <u>ohne</u> Mengenregulierung, Fertigmontageset ■ serienbezogener Temperiergriff ■ Sicherheitssperre bei 38° C	Concealed wall thermostat 3/4" <u>without</u> flow control, assembly set ■ design handle for temp. control ■ locking device at 38° C		586,-	686,-	748,-
			952,-	626,-	779,-	1.239,-
			1.858,-			
Benötigt Required						
	649.20.634 Anschlußadapter 3/4" ■ Anschlußadapter, Abschlußstopfen ■ passend zu Einbaukörper 649.40.555	Connection adapter 3/4" ■ connection adapter, end plug ■ matching to wall body 649.40.555		146,-		
	649.40.555 Unterputz-Einbaukörper 3/4" ■ zu Fertigmontageset 615.40.555 ■ Kartusche mit Schmutzfangsieben ■ für Nass- und Trockenbau geeignet ■ Durchflussrate 64,2 l/min bei 3 bar ■ <u>ohne</u> Absperrung	Concealed thermostat body 3/4" ■ for assembly set 615.40.555 ■ cartridge with filter screens ■ for wetwall and drywall construction ■ flow rate 64,2 l/min at 3 bar ■ <u>without</u> shut-off		1.636,-		



Maßzeichnungen unter www.joerger.de - Menü SERVICE.
 Technical specifications under www.joerger.de - menu SERVICE.

A chrom chrome	[.000]	E platin matt platinum matt	[.066]
B silbernickel polished nickel	[.035]	F nerz matt mink matt	[.096]
C nerz mink	[.095]	G schwarz-matt black matt	[.092]
C nickel matt satin nickel	[.036]	H farbig coloured	[.xxx]
D edelmessing sunshine	[.040]	H bronze bronze	[.011]
D platin platinum	[.065]	I gold gold	[.020]
E edelmess.matt sunshine matt	[.041]	L roségold rosegold	[.022]
E gold matt gold matt	[.021]	L roségold matt rosegold matt	[.023]



Unterputz-Ventile | Valves concealed

	632.50.234	Unterputz-Ventil Fertigmontageset ■ Griff ■ Hülse, Schubrosette	Concealed wall valve assembly set ■ design handle ■ socket with adjustable escutcheon	A	B	C	D	E	
					189,-	238,-	264,-	279,-	359,-
					F	G	H	I	L
				319,-	318,-	412,-	469,-	612,-	
Benötigt Required									
	649.20.350	Unterputz-Ventil 1/2", Einbaukörper ■ rechtsschließend, ker. Scheiben	Concealed wall valve 1/2", body ■ clockwise closure, ceramic discs	A					
					66,-				
	649.20.355	Unterputz-Ventil 1/2", Einbaukörper ■ linksschließend, ker. Scheiben	Concealed wall valve 1/2", body ■ counter-clockwise closure, cer. discs						
	649.20.450	Unterputz-Ventil 3/4", Einbaukörper ■ rechtsschließend, ker. Scheiben	Concealed wall valve 3/4", body ■ clockwise closure, ceramic discs	A					
					99,-				
	649.20.455	Unterputz-Ventil 3/4", Einbaukörper ■ linksschließend, ker. Scheiben	Concealed wall valve 3/4", body ■ counter-clockwise closure, cer. discs						

Unterputz-Umstellung | Diverter concealed

	632.40.650	Unterputz 3-Wege Umstellung 1/2" Fertigmontageset ■ Griff ■ Hülse, Schubrosette	Concealed 3-position diverter 1/2" assembly set ■ design handle ■ socket with adjustable escutcheon	A	B	C	D	E	
					199,-	248,-	274,-	289,-	369,-
					F	G	H	I	L
				329,-	328,-	422,-	479,-	622,-	
Benötigt Required									
	649.40.600	Unterputz 3-Wege Umstellung 1/2" Einbaukörper ■ zu Fertigmontageset 632.40.650	Concealed 3-position diverter 1/2" diverter body ■ for assembly set 632.40.650	A					
					236,-				

Brausen | Showers

	632.13.300	Duschgarnitur, komplett ■ Wandrohr 800 mm, mit Schieber ■ Handbrause mit 3 Strahlarten, Anti-Kalk-System und Rückfluss- verhinderer ■ Metall-Brauseschlauch 1750 mm, beidseitig mit drehbarem Konus	Shower bar set, complete ■ wall bar 800 mm, with slider ■ hand shower with 3 jets, anticalc. system and backflow preventer ■ metal shower hose 1750 mm, both sides with turning cone	A	B	C	D	E	
					198,-	666,-	944,-	1.065,-	1.624,-
					F	G	H	I	L
				1.398,-	986,-	1.499,-	1.859,-	2.824,-	
Achtung! Dieser Artikel kann nicht in farbig geliefert werden. Attention! This item can not be delivered in coloured.									
	632.13.350	Duschstange, lose ■ Wandrohr 800 mm, mit Schieber	Shower bar, separate ■ wall bar 800 mm, with slider	A	B	C	D	E	
					139,-	387,-	515,-	574,-	849,-
					F	G	H	I	L
				739,-	509,-	745,-	1.098,-	1.709,-	

A chrom chrome	[.000]	E platin matt platinum matt	[.066]
B silbernickel polished nickel	[.035]	F nerz matt mink matt	[.096]
C nerz mink	[.095]	G schwarz-matt black matt	[.092]
C nickel matt satin nickel	[.036]	H farbig coloured	[.xxx]
D edelmessing sunshine	[.040]	H bronze bronze	[.011]
D platin platinum	[.065]	I gold gold	[.020]
E edelmess.matt sunshine matt	[.041]	L roségold rosegold	[.022]
E gold matt gold matt	[.021]	L roségold matt rosegold matt	[.023]



- 632.13.305** Duschgarnitur, komplett
- Wandrohr 800 mm, mit Schieber
 - Handbrause aus Metall mit einer Strahlart, Anti-Kalk-System und Rückflussverhinderer
 - Metall-Brauseschlauch 1750 mm, beidseitig mit drehbarem Konus

- Shower bar set, complete**
- wall bar 800 mm, with slider
 - metal hand shower with 1 jet, anticalc. system and backflow preventer
 - metal shower hose 1750 mm, both sides with turning cone

A	B	C	D	E
319,-	774,-	1.022,-	1.132,-	1.674,-
F	G	H	I	L
1.458,-	1.092,-	1.596,-	1.898,-	2.919,-



- 632.13.210** Schlauchbrausegarnitur
- Wandanschlußbogen 1/2", Schubrosette
 - Wand-Brausehalter
 - Handbrause mit 3 Strahlarten, Anti-Kalk-System und Rückflussverhinderer
 - Metall-Brauseschlauch 1500 mm, beidseitig mit drehbarem Konus

- Shower combination**
- wall elbow connection 1/2", escutcheon
 - wall fitting for hand shower
 - hand shower with 3 jets, anticalc. system and backflow preventer
 - metal shower hose 1500 mm, both sides with turning cone

Achtung! Dieser Artikel kann nicht in farbig geliefert werden.
Attention! This item can not be delivered in coloured.

A	B	C	D	E
216,-	389,-	532,-	594,-	889,-
F	G	H	I	L
772,-	628,-	978,-	1.114,-	1.489,-



- 632.13.215** Schlauchbrausegarnitur
- Wandanschlußbogen 1/2", Schubrosette
 - Wand-Brausehalter
 - Handbrause aus Metall mit einer Strahlart, Anti-Kalk-System und Rückflussverhinderer
 - Metall-Brauseschlauch 1500 mm, beidseitig mit drehbarem Konus

- Shower combination**
- wall elbow connection 1/2", escutcheon
 - wall fitting for hand shower
 - metal hand shower with 1 jet, anticalc. system and backflow preventer
 - metal shower hose 1500 mm, both sides with turning cone

A	B	C	D	E
337,-	499,-	608,-	662,-	934,-
F	G	H	I	L
826,-	734,-	1.068,-	1.198,-	1.586,-



- 632.13.150** Wandanschlußbogen 1/2", ohne Haken
- Brauseabgang 1/2"
 - mit Rückflussverhinderer, Rosette

- Wall elbow connection 1/2", without cradle**
- discharge 1/2"
 - with backflow preventer, escutcheon

A	B	C	D	E
89,-	98,-	106,-	112,-	178,-
F	G	H	I	L
152,-	148,-	187,-	239,-	306,-



- 632.13.270** Wand-Brausehalter

- Wall fitting for hand shower**

A	B	C	D	E
79,-	79,-	89,-	99,-	158,-
F	G	H	I	L
132,-	114,-	154,-	198,-	296,-









- 619.13.237** Hygienebrausegarnitur
- Wandbrausehalter und -anschlußbogen 1/2", Schubrosette
 - Hygienebrause, modern (649.13.337), komplett aus Metall
 - einstrahlig, Bedienung über Druckhebel
 - Metall-Brauseschlauch 1250 mm

- Ablution spray combination**
- wall fitting and elbow connection 1/2"
 - spray handshower, modern (649.13.337), completely metal
 - one jet, push-lever operation
 - flexible metal shower hose 1250 mm

A	B	C	D	E
271,-	436,-	489,-	569,-	668,-
F	G	H	I	L
629,-	659,-	994,-	1.169,-	1.532,-









A chrom chrome	[.000]	E platin matt platinum matt	[.066]
B silbernickel polished nickel	[.035]	F nerz matt mink matt	[.096]
C nerz mink	[.095]	G schwarz-matt black matt	[.092]
C nickel matt satin nickel	[.036]	H farbig coloured	[.xxx]
D edelmessing sunshine	[.040]	H bronze bronze	[.011]
D platin platinum	[.065]	I gold gold	[.020]
E edelmess.matt sunshine matt	[.041]	L roségold rosegold	[.022]
E gold matt gold matt	[.021]	L roségold matt rosegold matt	[.023]

Maßzeichnungen unter www.joerger.de - Menü SERVICE.
 Technical specifications under www.joerger.de - menu SERVICE.

	615.20.237	1-Hand Batterie 1/2" für Hygiene-Brause, Fertigmontageset <ul style="list-style-type: none"> Rosette, Griff 	Concealed single lever 1/2" for ablution spray, assembly set <ul style="list-style-type: none"> escutcheon, handle 	A	B	C	D	E
				271,-	359,-	439,-	496,-	580,-
				F	G	H	I	L
			549,-	439,-	526,-	658,-	729,-	
Benötigt Required								
	649.20.237	Unterputz 1-Hand Batterie 1/2", Einbaukörper <ul style="list-style-type: none"> Kartusche mit keramischen Scheiben zu Fertigmontageset 615.20.237 	Single lever mixer 1/2", concealed body <ul style="list-style-type: none"> cartridge with ceramic discs for assembly set 615.20.237 	A	B	C	D	E
				125,-	169,-	208,-	229,-	268,-
				F	G	H	I	L
			249,-	224,-	258,-	329,-	396,-	
Empfohlen Recommended								
	649.13.885	Regenbrause 1/2", ø 250 mm <ul style="list-style-type: none"> Ausführung Metall mit Kugelgelenk Anti-Kalk-System 	Rain shower head 1/2", ø 250 mm <ul style="list-style-type: none"> material metal with ball joint with anticalcareous system 	A	B	C	D	E
				168,-	359,-	618,-	708,-	1.049,-
				F	G	H	I	L
			899,-	589,-	968,-	1.599,-	2.196,-	
Empfohlen Recommended								
	649.13.755	Wandarm 1/2" <ul style="list-style-type: none"> Ausladung 350 mm 	Wall bracket 1/2" <ul style="list-style-type: none"> projection 350 mm 	A	B	C	D	E
				129,-	288,-	316,-	349,-	439,-
				F	G	H	I	L
			399,-	288,-	328,-	479,-	539,-	
Empfohlen Recommended								
	649.13.519	Seitenbrause 1/2" <ul style="list-style-type: none"> Rosette ø 130 mm, Wandmontage Brausekopf schwenkbar, 20° Anti-Kalk-System Material: Kunststoff 	Body spray side shower 1/2" <ul style="list-style-type: none"> escutcheon ø 130 mm, wall assembly swivel shower head, 20° anticalcareous system plastic 	A	B	C	D	E
				167,-	326,-	385,-	399,-	542,-
				F	G	H	I	L
			496,-	376,-	472,-	634,-	949,-	
<p>Achtung! Dieser Artikel kann nicht in farbig geliefert werden. Attention! This item can not be delivered in coloured.</p>								
	649.13.381	Handbrause 1/2" <ul style="list-style-type: none"> Anti-Kalk-System 3 Strahlarten: Normal, Soft, Schwall Anschluß 1/2" Ausführung ABS 	Hand shower 1/2" <ul style="list-style-type: none"> anticalcareous system with 3 jets: normal, soft, cascade connection 1/2" material ABS 	A	B	C	D	E
				69,-	172,-	259,-	299,-	476,-
				F	G	H	I	L
			392,-	289,-	449,-	668,-	869,-	
<p>Achtung! Dieser Artikel kann nicht in farbig geliefert werden. Attention! This item can not be delivered in coloured.</p>								
	649.13.391	Handbrause 1/2" <ul style="list-style-type: none"> Anti-Kalk-System Anschluß 1/2" Ausführung Metall 	Hand shower 1/2" <ul style="list-style-type: none"> anticalcareous system connection 1/2" material metal 	A	B	C	D	E
				208,-	398,-	426,-	464,-	578,-
				F	G	H	I	L
			546,-	394,-	586,-	718,-	956,-	
<p>Achtung! Dieser Artikel kann nicht in farbig geliefert werden. Attention! This item can not be delivered in coloured.</p>								

A chrom chrome	[.000]	E platin matt platinum matt	[.066]
B silbernickel polished nickel	[.035]	F nerz matt milk matt	[.096]
C nerz milk	[.095]	G schwarz-matt black matt	[.092]
C nickel matt satin nickel	[.036]	H farbig coloured	[.xxx]
D edelmessing sunshine	[.040]	H bronze bronze	[.011]
D platin platinum	[.065]	I gold gold	[.020]
E edelmess.matt sunshine matt	[.041]	L roségold rosegold	[.022]
E gold matt gold matt	[.021]	L roségold matt rosegold matt	[.023]

Accessoires für Handtücher | Accessories for towels

		A	B	C	D	E
	632.00.002 Handtuchhalter ■ Rohre beweglich, ca. 400 mm	Towel bar		■ swivel bars, approx. 400 mm		
		89,-	249,-	378,-	464,-	718,-
		612,-	329,-	464,-	829,-	969,-
	632.00.004 Handtuchhalter ■ Rohr starr, ca. 410 mm	Towel bar		■ rigid bar, approx. 410 mm		
		69,-	198,-	234,-	256,-	324,-
		292,-	245,-	342,-	464,-	728,-
	632.00.047 Handtuchring	Towel ring				
		75,-	225,-	399,-	433,-	572,-
		506,-	238,-	326,-	679,-	784,-
	632.00.022 Handtuchhaken	Robe hanger				
		25,-	45,-	62,-	99,-	129,-
		116,-	86,-	128,-	146,-	199,-
	632.00.040 Badetuchhalter ■ ca. 800 mm	Bath towel bar		■ approx. 800 mm		
		87,-	248,-	334,-	408,-	596,-
		512,-	299,-	584,-	759,-	1.399,-
	632.00.041 Badetuchhalter, doppelt ■ ca. 600 mm	Bath towel bar, double		■ approx. 600 mm		
		118,-	422,-	594,-	742,-	1.084,-
		928,-	482,-	846,-	1.474,-	1.996,-
	632.00.048 Badetuch-Ablage ■ ca. 600 x 260 mm	Bath towel shelf		■ approx. 600 x 260 mm		
		187,-	536,-	886,-	1.069,-	1.649,-
		1.389,-	608,-	1.335,-	1.842,-	2.678,-
	632.00.031 Wannengriff ■ ca. 300 mm	Tub handle		■ approx. 300 mm		
		76,-	212,-	309,-	342,-	512,-
		436,-	278,-	426,-	609,-	862,-

A chrom chrome	[.000]	E platin matt platinum matt	[.066]
B silbernickel polished nickel	[.035]	F nerz matt mink matt	[.096]
C nerz mink	[.095]	G schwarz-matt black matt	[.092]
C nickel matt satin nickel	[.036]	H farbig coloured	[.xxx]
D edelmessing sunshine	[.040]	H bronze bronze	[.011]
D platin platinum	[.065]	I gold gold	[.020]
E edelmess.matt sunshine matt	[.041]	L roségold rosegold	[.022]
E gold matt gold matt	[.021]	L roségold matt rosegold matt	[.023]

Maßzeichnungen unter www.joerger.de - Menü SERVICE.
 Technical specifications under www.joerger.de - menu SERVICE.

	634.00.104 Gästehandtuchkorb, eckig ■ mit Ablage ■ Korbgröße 260 x 150 x 190 mm	Guest towel basket, angular ■ with shelf ■ basket size 260 x 150 x 190 mm	A	B	C	D	E
			230,-	314,-	356,-	389,-	528,-
			F	G	H	I	L
			466,-	492,-	675,-	849,-	1.499,-

Accessoires für Waschplatz | Accessories for washstands

	632.00.007 Seifenhalter, komplett ■ Wandmodell ■ Seifenschale aus Kristallglas	Soap dish holder, complete ■ wall version ■ crystal glass dish	A	B	C	D	E
			49,-	94,-	154,-	226,-	293,-
			F	G	H	I	L
			258,-	152,-	229,-	318,-	369,-

732.00.307 Seifenschale, lose	Glass dish, separate	A				
		19,-				

	632.00.017 Seifenhalter, komplett ■ Standmodell ■ Seifenschale aus Kristallglas	Soap dish holder, complete ■ free standing version ■ crystal glass dish	A	B	C	D	E
			44,-	84,-	108,-	169,-	215,-
			F	G	H	I	L
			189,-	179,-	214,-	279,-	369,-

	632.00.005 Lotionsspender, komplett ■ Wandmodell ■ Einfache Befüllung von oben ■ Betätigung von unten ■ Dosiermenge: 0,5 ml/Hub	Soap dispenser, complete ■ wall version ■ easy filling from above ■ actuation from below ■ dosage: 0.5 ml / stroke	A	B	C	D	E
			116,-	179,-	219,-	254,-	359,-
			F	G	H	I	L
			289,-	268,-	356,-	468,-	728,-

	632.00.016 Lotionsspender, komplett ■ Standmodell ■ Ausführung Metall	Soap dispenser, complete ■ free standing version ■ brass	A	B	C	D	E
			67,-	169,-	272,-	335,-	534,-
			F	G	H	I	L
			446,-	308,-	484,-	738,-	989,-

	634.00.105 Schwammkorb ■ rechteckig, 260 x 130 mm	Sponge basket ■ rectangular, 260 x 130 mm	A	B	C	D	E
			199,-	238,-	279,-	332,-	462,-
			F	G	H	I	L
			396,-	348,-	459,-	589,-	859,-

	634.00.106 Eckschwammkorb ■ 195 x 195 mm	Corner sponge basket ■ 195 x 195 mm	A	B	C	D	E
			195,-	234,-	275,-	328,-	458,-
			F	G	H	I	L
			390,-	344,-	455,-	585,-	855,-

Maßzeichnungen unter www.joerger.de - Menü SERVICE.
 Technical specifications under www.joerger.de - menu SERVICE.

A chrom chrome	[.000]	E platin matt platinum matt	[.066]
B silbernickel polished nickel	[.035]	F nerz matt milk matt	[.096]
C nerz milk	[.095]	G schwarz-matt black matt	[.092]
C nickel matt satin nickel	[.036]	H farbig coloured	[.xxx]
D edelmessing sunshine	[.040]	H bronze bronze	[.011]
D platin platinum	[.065]	I gold gold	[.020]
E edelmess.matt sunshine matt	[.041]	L roségold rosegold	[.022]
E gold matt gold matt	[.021]	L roségold matt rosegold matt	[.023]

	632.00.036 Glashalter, komplett <ul style="list-style-type: none"> Wandmodell Glas aus Kristallglas, seidenmatt 	Tumbler holder, complete <ul style="list-style-type: none"> wall version crystal glass tumbler, frosted 	A	B	C	D	E
				54,-	99,-	159,-	232,-
			F	G	H	I	L
			262,-	158,-	234,-	322,-	374,-
	732.00.336 Mundglas, seidenmatt, lose	Glass tumbler, frosted, separate	A				
			19,-				

	632.00.046 Glashalter, komplett <ul style="list-style-type: none"> Standmodell Glas aus Kristallglas, seidenmatt 	Tumbler holder, complete <ul style="list-style-type: none"> free standing version crystal glass tumbler, frosted 	A	B	C	D	E
				49,-	89,-	114,-	174,-
			F	G	H	I	L
			194,-	184,-	218,-	284,-	374,-

Accessoires für WC-Bereich | Accessories for w.c. area

	632.00.014 Papierhalter <ul style="list-style-type: none"> beweglicher Bügel 	Toilet paper roll holder <ul style="list-style-type: none"> mobile bracket 	A	B	C	D	E
				79,-	149,-	208,-	247,-
			F	G	H	I	L
			286,-	274,-	459,-	576,-	946,-

	632.00.015 Reserve-Papierhalter	Spare toilet paper roll holder	A	B	C	D	E
				39,-	78,-	119,-	138,-
			F	G	H	I	L
			159,-	132,-	246,-	318,-	489,-

	632.00.000 Klosettbürstengarnitur, komplett <ul style="list-style-type: none"> wandhängendes Modell Glas aus Kristallglas, seidenmatt 	Toilet brush holder set, complete <ul style="list-style-type: none"> suspended model crystal glass, frosted 	A	B	C	D	E
				86,-	139,-	198,-	257,-
			F	G	H	I	L
			292,-	248,-	399,-	549,-	728,-
	799.00.302 Bürstenglas, lose	Glass, separate	A				
			29,-				
	799.00.237 Bürstenkopf, lose	Brush, separate	A				
			22,-				

Maßzeichnungen unter www.joerger.de - Menü SERVICE.
 Technical specifications under www.joerger.de - menu SERVICE.

A chrom chrome	[.000]	E platin matt platinum matt	[.066]
B silbernickel polished nickel	[.035]	F nerz matt mink matt	[.096]
C nerz mink	[.095]	G schwarz-matt black matt	[.092]
C nickel matt satin nickel	[.036]	H farbig coloured	[.xxx]
D edelmessing sunshine	[.040]	H bronze bronze	[.011]
D platin platinum	[.065]	I gold gold	[.020]
E edelmess.matt sunshine matt	[.041]	L roségold rosegold	[.022]
E gold matt gold matt	[.021]	L roségold matt rosegold matt	[.023]



632.00.001 Klosettbürstengarnitur, komplett
 ■ stehendes Modell
 ■ Bürstentopf aus Metall

Toilet brush holder set, complete
 ■ floor standing model
 ■ brush holder out of brass

A	B	C	D	E
118,-	189,-	249,-	294,-	389,-
F	G	H	I	L
328,-	426,-	668,-	749,-	1.279,-

Spiegel | Mirrors



649.00.414 Kosmetikspiegel, beleuchtet
 ■ schwenk- und ausziehbar
 ■ 3-fache Vergrößerung
 ■ Direktanschluss
 ■ Spiegeldurchmesser 185 mm
 ■ Rahmendurchmesser 250 mm
 ■ Kalt-, Warm- und Taglicht durch Piezzo-Schalter umschaltbar

Cosmetic mirror, incl. lighting
 ■ swivelling and extendable
 ■ magnification 3:1
 ■ direct connection
 ■ mirror diameter 185 mm
 ■ frame diameter 250 mm
 ■ cold, warm and day light switchable by Piezzo switch

A	B	C	D	E
556,-	988,-	1.214,-	1.418,-	1.828,-
F	G	H	I	L
1.684,-	1.214,-	1.549,-	2.138,-	2.998,-



Oberflächen | colours

Folgende Oberflächen sind bei dieser Serie möglich |
The following colours are possible with this collection

chrom		chrome	[.000]	PG A
silbernickel		polished nickel	[.035]	PG B
nerz		mink	[.095]	PG C
nickel matt		satin nickel	[.036]	PG C
edelmessing		sunshine	[.040]	PG D
platin		platinum	[.065]	PG D
edelmessing matt		sunshine matt	[.041]	PG E
gold matt		gold matt	[.021]	PG E
platin matt		platinum matt	[.066]	PG E
nerz matt		mink matt	[.096]	PG F
schwarz matt		black matt	[.092]	PG G
weiß matt		white matt	[.052]	PG G
bronze		bronze	[.011]	PG H
gold		gold	[.020]	PG I
roségold		rosegold	[.022]	PG L
roségold matt		rosegold matt	[.023]	PG L

Andere Oberflächen auf Anfrage |
Different colours on request

Auf Anfrage können wir Produkte von Drittanbietern auch gerne passend zu unseren Oberflächen veredeln (vorbehaltlich der Eignungsprüfung) | Third-party products may be plated matching to our colours on request (subject to valuation of suitability)

Waschtisch | Washbasin

ab Seite | from page 036

Bidet | Bidet

ab Seite | from page 038

Wanne | Bath tub

ab Seite | from page 039

Dusche | Shower

ab Seite | from page 041

Accessoires | Accessories

ab Seite | from page 048

CHARLESTON ROYAL

Maßzeichnungen unter www.joerger.de - Menü SERVICE.
 Technical specifications under www.joerger.de - menu SERVICE.

A chrom chrome	[.000]	E platin matt platinum matt	[.066]
B silbernickel polished nickel	[.035]	F nerz matt milk matt	[.096]
C nerz milk	[.095]	G schwarz-matt black matt	[.092]
C nickel matt satin nickel	[.036]	G weiß-matt white matt	[.052]
D edelmessing sunshine	[.040]	H bronze bronze	[.011]
D platin platinum	[.065]	I gold gold	[.020]
E edelmess.matt sunshine matt	[.041]	L roségold rosegold	[.022]
E gold matt gold matt	[.021]	L roségold matt rosegold matt	[.023]

Waschtisch Batterien | Washbasin mixer

		A	B	C	D	E
	619.30.300 Waschtisch 3-Loch Batterie ½"					
	<ul style="list-style-type: none"> Ausladung 150 mm; Höhe 270 mm Auslauf schwenkbar Seitenrandventile mit keramischen Oberteilen ½" Exzenter-Ablaufgarnitur 1 ¼" empfohlen: 2x 649.15.530 - Kupferrohr 300 mm 	Washbasin 3-hole mixer ½"				
		799,-	1.029,-	1.129,-	1.236,-	1.519,-
		1.376,-	1.254,-	1.526,-	1.672,-	2.689,-
	619.10.333 Waschtisch 1-Hand Batterie					
	<ul style="list-style-type: none"> Ausladung 150 mm; Höhe 290 mm Auslauf schwenkbar Kartusche mit keramischen Scheiben Exzenter-Ablaufgarnitur 1 ¼" 2 Kupferrohre M10x1 x 400 mm 	Single lever washbasin mixer				
		498,-	772,-	862,-	956,-	1.189,-
		1.074,-	1.078,-	1.368,-	1.315,-	2.529,-
	Variante Alternative					
	619.10.334 Waschtisch 1-Hand Batterie					
	<ul style="list-style-type: none"> <u>ohne</u> Exzenter-Ablaufgarnitur 	Single lever washbasin mixer				
		476,-	644,-	712,-	764,-	889,-
		816,-	915,-	1.124,-	972,-	1.948,-
	619.10.353 Waschtisch 1-Hand Batterie, XXL					
	<ul style="list-style-type: none"> Ausladung 240 mm; Höhe 290 mm Auslauf schwenkbar Kartusche mit keramischen Scheiben Exzenter-Ablaufgarnitur 1 ¼" 2 Kupferrohre M10x1 x 400 mm 	Single lever washbasin mixer, XXL				
		519,-	832,-	958,-	1.075,-	1.357,-
		1.214,-	1.091,-	1.376,-	1.508,-	2.539,-
	Variante Alternative					
	619.10.354 Waschtisch 1-Hand Batterie, XXL					
	<ul style="list-style-type: none"> <u>ohne</u> Exzenter-Ablaufgarnitur 	Single lever washbasin mixer, XXL				
		508,-	726,-	817,-	898,-	1.128,-
		1.016,-	897,-	1.106,-	1.248,-	2.029,-
	619.10.222 Handwaschbecken 1-Hand Batterie					
	<ul style="list-style-type: none"> Ausladung 85 mm; Höhe 230 mm Auslauf schwenkbar Kartusche mit keramischen Scheiben Exzenter-Ablaufgarnitur 1 ¼" 2 Kupferrohre M10x1 x 400 mm 	Single lever mini washbasin mixer				
		598,-	759,-	842,-	946,-	1.149,-
		1.055,-	1.142,-	1.426,-	1.234,-	2.636,-
	Variante Alternative					
	619.10.224 Handwaschbecken 1-Hand Batterie					
	<ul style="list-style-type: none"> <u>ohne</u> Exzenter-Ablaufgarnitur 	Single lever mini washbasin mixer				
		539,-	646,-	694,-	766,-	916,-
		860,-	972,-	1.174,-	966,-	2.006,-
	619.10.300 Waschtisch 1-Loch Batterie ½"					
	<ul style="list-style-type: none"> Ausladung 150 mm; Höhe 265 mm Auslauf schwenkbar Oberteile ½", keramische Scheiben Exzenter-Ablaufgarnitur 1 ¼" 2 Kupferrohre M10x1 x 400 mm 	Washbasin 1-hole mixer ½"				
		686,-	929,-	1.058,-	1.167,-	1.458,-
		1.316,-	1.159,-	1.438,-	1.638,-	2.596,-

CHARLESTON ROYAL

Maßzeichnungen unter www.joerger.de - Menü SERVICE.
 Technical specifications under www.joerger.de - menu SERVICE.

A chrom chrome	[.000]	E platin matt platinum matt	[.066]
B silbernickel polished nickel	[.035]	F nerz matt milk matt	[.096]
C nerz milk	[.095]	G schwarz-matt black matt	[.092]
C nickel matt satin nickel	[.036]	G weiß-matt white matt	[.052]
D edelmessing sunshine	[.040]	H bronze bronze	[.011]
D platin platinum	[.065]	I gold gold	[.020]
E edelmess.matt sunshine matt	[.041]	L roségold rosegold	[.022]
E gold matt gold matt	[.021]	L roségold matt rosegold matt	[.023]



- 619.10.600 Standventil 1/2"**
- Ausladung 150 mm; Höhe 265 mm
 - Auslauf schwenkbar
 - Keramik-Innenoberteil 1/2"
 - 1 Kupferrohr M10x1 x 400 mm
 - auf Wunsch auch mit Ausladung 85 mm zum gleichen Preis

- Deck mount tap 1/2"**
- spout projection 150 mm; height 265 mm; swivelling spout
 - ceramic internal upper part 1/2"
 - 1 copper tube M10x1 x 400 mm
 - also available on request with spout projection 85 mm - at same price

A	B	C	D	E
664,-	899,-	1.029,-	1.139,-	1.432,-
F	G	H	I	L
1.288,-	1.016,-	1.212,-	1.606,-	2.574,-

Waschtisch Batterien, bodenstehend | Washbasin mixer, free standing



- 619.10.854 Waschtisch 1-Hand Batterie**
- für freistehende Montage
 - Ausladung 220 mm
 - Auslauf schwenkbar
 - ohne Ablaufgarnitur
 - Standrohr mit Befestigungsflansch
 - Luftsprudler
 - Kartusche mit keramischen Scheiben
 - Höhe gesamt 1147 -1227 mm
 - Höhe bis Luftsprudler 1032 - 1112 mm

- Single lever washbasin mixer**
- free standing assembly
 - spout projection 220 mm
 - swivelling spout
 - without waste
 - Pillar tube with flange
 - aerator
 - ceramic internal upper part
 - height 1147 - 1227 mm
 - aerator height 1032 - 1112 mm

A	B	C	D	E
1.632,-	2.154,-	2.585,-	2.819,-	3.528,-
F	G	H	I	L
3.096,-	2.618,-	3.189,-	4.278,-	4.995,-

Benötigt | Required

- 649.10.970 Bausatz-Vormontage**
- Bodenplatte mit Befestigungsset
 - zu Fertigmontageset 619.10.834 und 619.10.854



- Assembly set for pre-installation**
- joint plate with fixing set
 - for assembly set 619.10.834 and 619.10.854

A	B	C	D	E
549,-				

Wand-Waschtisch 3-Loch Batterie | Wall-Washbasin 3-hole mixer



- 619.30.360 Wand-Waschtisch 3-Loch Batterie, Fertigmontageset**
- Wand-Auslauf, Ausladung 200 - 212 mm
 - Griff, Hülse, Schubrosette
 - Oberteile 1/2", keramische Scheiben

- Wall washbasin 3-hole mixer, assembly set**
- wall spout, projection 200 - 212 mm
 - design handle, socket with adjustable escutcheon
 - cartridges 1/2", with ceramic discs

A	B	C	D	E
574,-	689,-	786,-	873,-	1.164,-
F	G	H	I	L
1.048,-	1.035,-	1.289,-	1.455,-	2.499,-

Variante | Alternative

- 619.30.365 Wand-Waschtisch 3-Loch Batterie XXL, Fertigmontageset**
- Ausladung 270 - 282 mm

- Wall washbasin 3-hole mixer XXL, assembly set**
- projection 270 - 282 mm

A	B	C	D	E
588,-	706,-	805,-	894,-	1.192,-
F	G	H	I	L
1.073,-	1.045,-	1.298,-	1.490,-	2.519,-

Benötigt | Required

- 649.30.380 Wand-Waschtisch 3-Loch Batterie, Einbaukörper 1/2"**
- 2 Anschlüsse, Stichmaß 204 mm
 - zu Fertigmontageset 619.30.360 und 619.30.365



- Wall washbasin 3-hole mixer concealed body 1/2"**
- 2 connections, center dist. 204 mm
 - for assembly set 619.30.360 and 619.30.365

A	B	C	D	E
296,-				

CHARLESTON ROYAL

Maßzeichnungen unter www.joerger.de - Menü SERVICE.
 Technical specifications under www.joerger.de - menu SERVICE.

A chrom chrome	[.000]	E platin matt platinum matt	[.066]
B silbernickel polished nickel	[.035]	F nerz matt milk matt	[.096]
C nerz milk	[.095]	G schwarz-matt black matt	[.092]
C nickel matt satin nickel	[.036]	G weiß-matt white matt	[.052]
D edelmessing sunshine	[.040]	H bronze bronze	[.011]
D platin platinum	[.065]	I gold gold	[.020]
E edelmess.matt sunshine matt	[.041]	L roségold rosegold	[.022]
E gold matt gold matt	[.021]	L roségold matt rosegold matt	[.023]

Wand-Waschtisch 1-Hand Batterien | Single lever wall-washbasin mixer

	619.20.360 Wand-Waschtisch 1-Hand Batterie 1/2", Fertigmontageset <ul style="list-style-type: none"> Wand-Auslauf Ausladung 207 - 222 mm Kartusche mit keramischen Scheiben Wandrosette 	Single lever wall washbasin mixer 1/2", assembly set <ul style="list-style-type: none"> wall spout projection 207 - 222 mm cartridge with ceramic discs escutcheon 	A	B	C	D	E
			468,-	562,-	738,-	821,-	1.094,-
			F	G	H	I	L
			985,-	955,-	1.214,-	1.368,-	2.428,-

Benötigt | Required

	649.20.362 Wand-Waschtisch 1-Hand Batterie 1/2", Einbaukörper <ul style="list-style-type: none"> Bedienhebel rechts zu Fertigmontageset 619.20.360 Kartusche mit ker. Scheiben 	Single lever wall washbasin mixer 1/2", concealed body <ul style="list-style-type: none"> control lever on the right for assembly set 619.20.360 cartridge with ceramic discs 	A				
			258,-				

	649.20.364 Wand-Waschtisch 1-Hand Batterie 1/2", Einbaukörper <ul style="list-style-type: none"> Bedienhebel links zu Fertigmontageset 619.20.360 Kartusche mit ker. Scheiben 	Single lever wall washbasin mixer 1/2", concealed body <ul style="list-style-type: none"> control lever on the left for assembly set 619.20.360 cartridge with ceramic discs 	A				
			258,-				

	619.10.111 Bidet 1-Hand Batterie <ul style="list-style-type: none"> Ausladung 115 mm; Höhe 150 mm Kartusche mit keramischen Scheiben Exzenter-Ablaufgarnitur 1 1/4" 2 Druckschläuche M10x1 x 450 mm 	Single lever bidet mixer <ul style="list-style-type: none"> spout projection 115 mm; height 150 mm cartridge with ceramic discs pop-up waste 1 1/4" 2 pressure hoses M10x1 x 450 mm 	A	B	C	D	E
			582,-	775,-	865,-	959,-	1.192,-
			F	G	H	I	L
			1.077,-	1.032,-	1.264,-	1.318,-	2.532,-

Zubehör für Waschtisch- und Bidet-Batterien | Supplies for washbasin and bidet mixer

	632.12.100 Eckventil 1/2" <ul style="list-style-type: none"> Ausladung 110 mm Fettkammer-Innenoberteil 1/2" Quetschverschraubung Schubrosette 	Angle valve 1/2" <ul style="list-style-type: none"> projection 110 mm cartridge 1/2" compression joint escutcheon 	A	B	C	D	E
			99,-	122,-	163,-	173,-	223,-
			F	G	H	I	L
			197,-	184,-	365,-	465,-	610,-

	649.15.530 Kupferrohr, 300 mm <ul style="list-style-type: none"> mit Bördel, für Quetschverschraubung 	Copper tube, 300 mm <ul style="list-style-type: none"> with flange, for compression joint 	A	B	C	D	E
			15,-	38,-	55,-	62,-	74,-
			F	G	H	I	L
			69,-	75,-	94,-	112,-	169,-

Variante | Alternative

	649.15.550 Kupferrohr, 500 mm <ul style="list-style-type: none"> mit Bördel, für Quetschverschraubung 	Copper tube, 500 mm <ul style="list-style-type: none"> with flange, for compression joint 	A	B	C	D	E
			20,-	58,-	77,-	87,-	102,-
			F	G	H	I	L
			97,-	77,-	96,-	134,-	219,-

	649.10.086 Rohrverlängerung, Höhe 150 mm <ul style="list-style-type: none"> Durchmesser 42 mm für 619.10.222, 619.10.224, 619.10.300, 619.10.333, 619.10.334, 619.10.353, 619.10.354, 619.10.600 	Body extension, height 150 mm <ul style="list-style-type: none"> diameter 42 mm for 619.10.222, 619.10.224, 619.10.300, 619.10.333, 619.10.334, 619.10.353, 619.10.354, 619.10.600 	A	B	C	D	E
			224,-	328,-	360,-	398,-	486,-
			F	G	H	I	L
			440,-	456,-	592,-	549,-	1.068,-

CHARLESTON ROYAL

Maßzeichnungen unter www.joerger.de - Menü SERVICE.
 Technical specifications under www.joerger.de - menu SERVICE.

A chrom chrome	[.000]	E platin matt platinum matt	[.066]
B silbernickel polished nickel	[.035]	F nerz matt mink matt	[.096]
C nerz mink	[.095]	G schwarz-matt black matt	[.092]
C nickel matt satin nickel	[.036]	G weiß-matt white matt	[.052]
D edelmessing sunshine	[.040]	H bronze bronze	[.011]
D platin platinum	[.065]	I gold gold	[.020]
E edelmess.matt sunshine matt	[.041]	L roségold rosegold	[.022]
E gold matt gold matt	[.021]	L roségold matt rosegold matt	[.023]



- 649.15.340** Waschtisch-Tassensiphon 1 1/4"
 ■ schwere Ausführung
 ■ Rosette
 ■ Abgangsrohr ø 32 mm
 ■ Tauchrohrlänge 165 mm

- Washbasin cupped siphon trap 1 1/4"**
 ■ heavy brass
 ■ escutcheon
 ■ outlet tube ø 32 mm
 ■ dip pipe 165 mm

A	B	C	D	E
195,-	296,-	368,-	429,-	568,-
F	G	H	I	L
498,-	378,-	539,-	686,-	832,-



- 649.15.270** Zwangsablaufventil
 ■ Schaftlänge 70 mm
 ■ für Waschbecken ohne Überlauf

- Restraint drain/waste**
 ■ length of shaft 70 mm
 ■ for washbasins without overflow

A	B	C	D	E
68,-	129,-	185,-	239,-	312,-
F	G	H	I	L
299,-	176,-	394,-	429,-	582,-



- 649.15.271** Zwangsablaufventil
 ■ Schaftlänge 100 mm
 ■ für Waschbecken ohne Überlauf

- Restraint drain/waste**
 ■ length of shaft 100 mm
 ■ for washbasins without overflow

A	B	C	D	E
72,-	138,-	196,-	254,-	329,-
F	G	H	I	L
318,-	186,-	418,-	454,-	616,-

Badewanne, Stand-Batterien | Bath tub mixer sets, deck mount



- 619.40.105** 4-Loch Wannenfüll- und Brausebatterie 1/2", für Standmontage
 ■ Ausladung 220 mm; Höhe 290 mm
 ■ 2 Seitenrandventile mit keramischen Oberteilen 1/2"
 ■ Metall-Brauseschlauch 2000 mm
 ■ Metall-Handbrause mit Anti-Kalk-System und Rückflussverhinderer

- Tub/shower mixer set 1/2" deck mount**
 ■ spout projection 220 mm; height 290 mm
 ■ 2 side valves, cer. internal upper parts 1/2"
 ■ metal shower hose 2000 mm
 ■ metal hand shower with anticalc. system and backflow preventer

A	B	C	D	E
1.422,-	1.879,-	2.098,-	2.232,-	2.514,-
F	G	H	I	L
2.384,-	1.916,-	2.534,-	2.754,-	3.526,-

Empfohlen | Recommended



- 649.40.160** Montageplatte, komplett
 ■ für 4-Loch Armaturen
 ■ Druckschläuche 1/2" x 1/2" x 600 mm
 ■ empfohlen: Schlauchkastensystem siehe Kapitel "Serienübergreifendes"

- Assembly plate, complete**
 ■ for deck mounted tub/shower mixer
 ■ pressure hoses 1/2"x 1/2" x 600 mm
 ■ recommended: system with hose box see chapter "universal products"

A	B	C	D	E
308,-				



- 619.30.445** 3-Loch Wannenfüll- und Brausebatterie 1/2", für Standmontage
 ■ Ausladung 220 mm; Höhe 290 mm
 ■ Luftsprudler
 ■ Kartusche mit keramischen Scheiben
 ■ automatische Umstellung Wanne/Brause
 ■ Metall-Brauseschlauch 2000 mm
 ■ Metall-Handbrause mit Anti-Kalk-System und Rückflussverhinderer

- Tub/shower mixer set 1/2" deck mount**
 ■ spout projection 220 mm; height 290 mm
 ■ aerator
 ■ ceramic cartridge
 ■ automatic diverter tub/shower
 ■ metal shower hose 2000 mm
 ■ metal hand shower with anticalc. system and backflow preventer

A	B	C	D	E
1.499,-	1.956,-	2.175,-	2.309,-	2.589,-
F	G	H	I	L
2.459,-	2.049,-	2.609,-	2.829,-	3.599,-

Empfohlen | Recommended



- 649.40.160** Montageplatte, komplett
 ■ für 4-Loch Armaturen
 ■ Druckschläuche 1/2" x 1/2" x 600 mm
 ■ empfohlen: Schlauchkastensystem siehe Kapitel "Serienübergreifendes"

- Assembly plate, complete**
 ■ for deck mounted tub/shower mixer
 ■ pressure hoses 1/2"x 1/2" x 600 mm
 ■ recommended: system with hose box see chapter "universal products"

A	B	C	D	E
308,-				

CHARLESTON ROYAL

Maßzeichnungen unter www.joerger.de - Menü SERVICE.
 Technical specifications under www.joerger.de - menu SERVICE.

A chrom chrome	[.000]	E platin matt platinum matt	[.066]
B silbernickel polished nickel	[.035]	F nerz matt mink matt	[.096]
C nerz mink	[.095]	G schwarz-matt black matt	[.092]
C nickel matt satin nickel	[.036]	G weiß-matt white matt	[.052]
D edelmessing sunshine	[.040]	H bronze bronze	[.011]
D platin platinum	[.065]	I gold gold	[.020]
E edelmess.matt sunshine matt	[.041]	L roségold rosegold	[.022]
E gold matt gold matt	[.021]	L roségold matt rosegold matt	[.023]

 <p>615.40.155 4-Loch Wannenrandkombination 1/2"</p> <ul style="list-style-type: none"> für Ab- und Überlaufgarnitur mit Wanneneinlauf, ohne Rohrunterbrecher Seitenrandventile, 2-Wege Umstellung Metall-Brauseschlauch 2000 mm Metall-Handbrause mit Anti-Kalk-System und Rückflussverhinderer 	<p>tub/shower combination 1/2"</p> <ul style="list-style-type: none"> for waste and overflow set with bath tub filler spout, without pipe interrupter side valves, 2-position diverter metal shower hose 2000 mm metal hand shower with anticalc. system and backflow preventer 	A	B	C	D	E
		1.154,-	1.474,-	1.598,-	1.774,-	2.018,-
		F	G	H	I	L
		1.924,-	1.639,-	2.208,-	2.224,-	3.132,-

Empfohlen | Recommended

 <p>649.40.160 Montageplatte, komplett</p> <ul style="list-style-type: none"> für 4-Loch Armaturen Druckschläuche 1/2" x 1/2" x 600 mm empfohlen: Schlauchkastensystem siehe Kapitel "Serienübergreifendes" 	<p>Assembly plate, complete</p> <ul style="list-style-type: none"> for deck mounted tub/shower mixer pressure hoses 1/2"x 1/2" x 600 mm recommended: system with hose box see chapter "universal products" 	A				
		308,-				

 <p>619.10.825 Wannen 1-Hand Batterie</p> <ul style="list-style-type: none"> für freistehende Montage Ausladung 355 mm Auslauf schwenkbar Umstellung Wanne/Brause Metall-Handbrause mit Anti-Kalk-System und Rückflussverhinderer Metall-Brauseschlauch 1500 mm Standrohr mit Befestigungsflansch Luftsprudler Kartusche mit keramischen Scheiben Höhe gesamt 940 - 1020 mm Höhe bis Luftsprudler 765 - 845 mm 	<p>Tub/shower mixer set</p> <ul style="list-style-type: none"> free standing assembly spout projection 355 mm swivelling spout diverter spout/hand shower metal hand shower with anticalc. system and backflow preventer metal shower hose 1500 mm Pillar tube with flange aerator ceramic internal upper part height 940 - 1020 mm aerator height 765 - 845 mm 	A	B	C	D	E
		2.092,-	2.969,-	3.456,-	3.819,-	4.844,-
		F	G	H	I	L
		4.439,-	2.999,-	3.869,-	5.382,-	5.948,-

Benötigt | Required

 <p>649.10.970 Bausatz-Vormontage</p> <ul style="list-style-type: none"> Bodenplatte mit Befestigungsset zu Fertigmontageset 619.10.820 	<p>Assembly set for pre-installation</p> <ul style="list-style-type: none"> joint plate with fixing set for assembly set 619.10.820 	A				
		549,-				

 <p>619.11.100 Wand-Wanneneinlauf 3/4"</p> <ul style="list-style-type: none"> Ausladung 214 - 226 mm Steckanschluß-Montage 	<p>Tub wall spout 3/4"</p> <ul style="list-style-type: none"> spout projection 214 - 226 mm special concealed wall attachment 	A	B	C	D	E
		297,-	376,-	446,-	475,-	589,-
		F	G	H	I	L
		538,-	399,-	499,-	638,-	889,-

Badewanne, Aufputz-Batterien | Bath tub mixer sets, exposed

 <p>619.20.505 1-Hand Aufputz-Wannenfüll- und Brausebatterie 1/2", mit Garnitur</p> <ul style="list-style-type: none"> Ausladung 192 mm Metall-Handbrause mit Anti-Kalk-System und Rückflussverhinderer Metall-Brauseschlauch 1500 mm, beidseitig mit drehbarem Konus 	<p>Single lever exposed tub/shower mixer 1/2", incl. shower set</p> <ul style="list-style-type: none"> spout projection 192 mm metal hand shower with anticalc. system and backflow preventer metal shower hose 1500 mm, both sides with turning cone 	A	B	C	D	E
		734,-	1.289,-	1.728,-	1.959,-	2.725,-
		F	G	H	I	L
		2.379,-	1.298,-	2.554,-	3.039,-	3.318,-

Variante | Alternative

 <p>619.20.515 1-Hand Aufputz-Wannenfüll- und Brausebatterie 1/2", ohne Garnitur</p> <ul style="list-style-type: none"> Ausladung 192 mm Kartusche mit keramischen Scheiben 	<p>Single lever exposed tub/shower mixer 1/2", without shower set</p> <ul style="list-style-type: none"> spout projection 192 mm cartridge with ceramic discs 	A	B	C	D	E
		519,-	999,-	1.328,-	1.549,-	2.308,-
		F	G	H	I	L
		2.008,-	1.032,-	2.139,-	2.579,-	2.822,-

CHARLESTON ROYAL



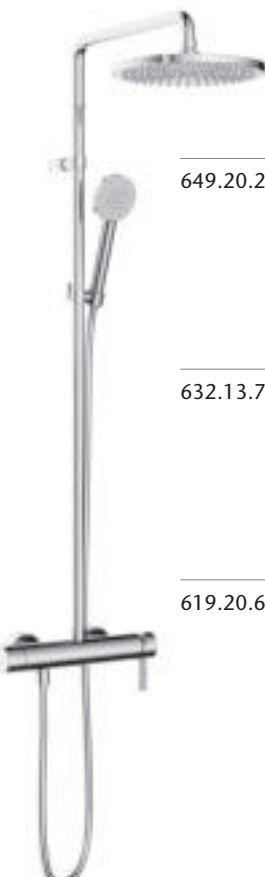
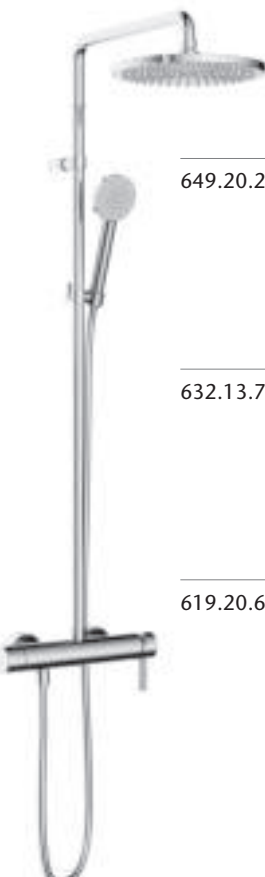
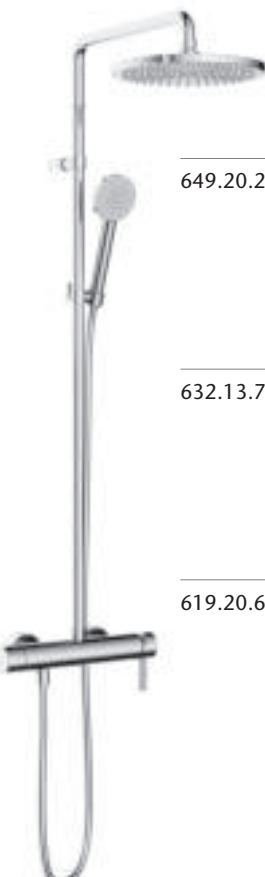
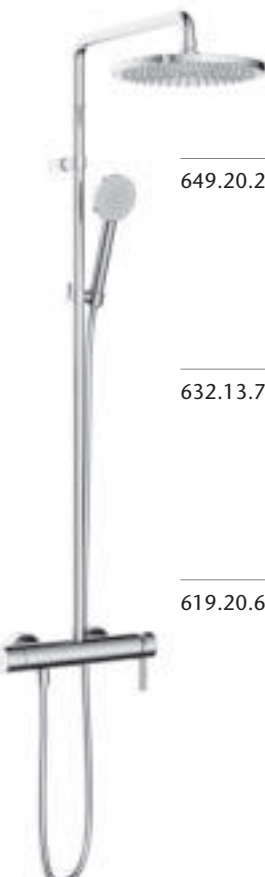

Maßzeichnungen unter www.joerger.de - Menü SERVICE.
 Technical specifications under www.joerger.de - menu SERVICE.

A chrom chrome	[.000]	E platin matt platinum matt	[.066]
B silbernickel polished nickel	[.035]	F nerz matt milk matt	[.096]
C nerz milk	[.095]	G schwarz-matt black matt	[.092]
C nickel matt satin nickel	[.036]	G weiß-matt white matt	[.052]
D edelmessing sunshine	[.040]	H bronze bronze	[.011]
D platin platinum	[.065]	I gold gold	[.020]
E edelmess.matt sunshine matt	[.041]	L roségold rosegold	[.022]
E gold matt gold matt	[.021]	L roségold matt rosegold matt	[.023]

619.20.665 – Aufputz Set mit Steigrohr | Exposed set with shower system

	649.13.844 Regenbrause ½", ø 240 mm	Rain shower head ½", ø 240 mm	A	B	C	D	E
	<ul style="list-style-type: none"> ■ Ausführung ganz in Metall ■ 3 mm ultra flach ■ mit Kugelgelenk ■ Anti-Kalk-System 	<ul style="list-style-type: none"> ■ full metal body ■ 3 mm ultra-thin ■ with ball joint ■ with anticalcareous system 	499,-	1.098,-	1.289,-	1.372,-	1.622,-
			F	G	H	I	L
			1.452,-	1.289,-	1.599,-	1.927,-	2.529,-
	649.20.260 Steigrohr, Umstellung, Wandarm	Supply pipe, diverter, wall bracket	A	B	C	D	E
	<ul style="list-style-type: none"> ■ zum Anschluß an die Brausebatterie ■ Ausladung 390 - 410 mm ■ in der Neigung und Höhe verstellbare Brausehalterung 	<ul style="list-style-type: none"> ■ to connect the exposed shower mixer ■ projection 390 - 410 mm ■ fitting for handshower adjustable in height and inclination 	398,-	669,-	838,-	996,-	1.276,-
			F	G	H	I	L
			1.122,-	1.182,-	1.520,-	1.736,-	2.399,-
	632.13.705 Brausegarnitur	Shower combination	A	B	C	D	E
	<ul style="list-style-type: none"> ■ Metall-Handbrause mit Anti-Kalk-System und Rückflussverhinderer ■ Metall-Brauseschlauch 1500 mm, beidseitig mit drehbarem Konus 	<ul style="list-style-type: none"> ■ metal hand shower with anticalc. system and backflow preventer ■ metal shower hose 1500 mm, both sides with turning cone 	279,-	499,-	546,-	648,-	796,-
			F	G	H	I	L
			784,-	598,-	896,-	1.138,-	1.379,-
	619.20.615 Aufputz-Brausebatterie ½"	Exposed shower mixer ½"	A	B	C	D	E
	<ul style="list-style-type: none"> ■ für Steigrohr ■ Brauseabgang ¾" 	<ul style="list-style-type: none"> ■ for supply pipe ■ discharge ¾" 	415,-	768,-	982,-	1.130,-	1.769,-
			F	G	H	I	L
			1.468,-	892,-	1.373,-	1.966,-	2.467,-

632.20.465 – Aufputz Set mit Steigrohr | Exposed set with shower system

	649.13.844 Regenbrause ½", ø 240 mm	Rain shower head ½", ø 240 mm	A	B	C	D	E
	<ul style="list-style-type: none"> ■ Ausführung ganz in Metall ■ 3 mm ultra flach ■ mit Kugelgelenk ■ Anti-Kalk-System 	<ul style="list-style-type: none"> ■ full metal body ■ 3 mm ultra-thin ■ with ball joint ■ with anticalcareous system 	499,-	1.098,-	1.289,-	1.372,-	1.622,-
			F	G	H	I	L
			1.452,-	1.289,-	1.599,-	1.927,-	2.529,-
	649.20.260 Steigrohr, Umstellung, Wandarm	Supply pipe, diverter, wall bracket	A	B	C	D	E
	<ul style="list-style-type: none"> ■ zum Anschluß an die Brausebatterie ■ Ausladung 390 - 410 mm ■ in der Neigung und Höhe verstellbare Brausehalterung 	<ul style="list-style-type: none"> ■ to connect the exposed shower mixer ■ projection 390 - 410 mm ■ fitting for handshower adjustable in height and inclination 	398,-	669,-	838,-	996,-	1.276,-
			F	G	H	I	L
			1.122,-	1.182,-	1.520,-	1.736,-	2.399,-
	632.13.705 Brausegarnitur	Shower combination	A	B	C	D	E
	<ul style="list-style-type: none"> ■ Metall-Handbrause mit Anti-Kalk-System und Rückflussverhinderer ■ Metall-Brauseschlauch 1500 mm, beidseitig mit drehbarem Konus 	<ul style="list-style-type: none"> ■ metal hand shower with anticalc. system and backflow preventer ■ metal shower hose 1500 mm, both sides with turning cone 	279,-	499,-	546,-	648,-	796,-
			F	G	H	I	L
			784,-	598,-	896,-	1.138,-	1.379,-
	632.20.260 Aufputz-Brausethermostat ½"	Exposed shower thermostat ½"	A	B	C	D	E
	<ul style="list-style-type: none"> ■ für Steigrohr ■ Brauseabgang ¾" 	<ul style="list-style-type: none"> ■ for supply pipe ■ discharge ¾" 	479,-	788,-	1.012,-	1.209,-	1.749,-
			F	G	H	I	L
			1.464,-	936,-	1.557,-	2.079,-	2.719,-

CHARLESTON ROYAL

Maßzeichnungen unter www.joerger.de - Menü SERVICE.
 Technical specifications under www.joerger.de - menu SERVICE.

A chrom chrome	[.000]	E platin matt platinum matt	[.066]
B silbernickel polished nickel	[.035]	F nerz matt mink matt	[.096]
C nerz mink	[.095]	G schwarz-matt black matt	[.092]
C nickel matt satin nickel	[.036]	G weiß-matt white matt	[.052]
D edelmessing sunshine	[.040]	H bronze bronze	[.011]
D platin platinum	[.065]	I gold gold	[.020]
E edelmess.matt sunshine matt	[.041]	L roségold rosegold	[.022]
E gold matt gold matt	[.021]	L roségold matt rosegold matt	[.023]

Dusche, Aufputz-Batterien | Shower mixer sets, exposed

	619.20.605 1-Hand Brausebatterie ½" für Aufputzmontage <ul style="list-style-type: none"> ■ Kartusche mit keramischen Scheiben ■ Brauseabgang ½" ■ verdeckte S-Anschlüsse ½" x ¾" 	Single lever exposed shower mixer ½" <ul style="list-style-type: none"> ■ cartridge with ceramic discs ■ discharge ½" ■ concealed S-connections ½" x ¾" 	A	B	C	D	E
			406,-	673,-	871,-	960,-	1.349,-
			F	G	H	I	L
			1.184,-	837,-	1.195,-	1.728,-	2.353,-

Unterputz-Hebelmischer ½" | Concealed single lever mixer ½"

	615.20.125 1-Hand Wannenfüll- und Brausebatterie ½" für UP-Montage, Fertigmontageset <ul style="list-style-type: none"> ■ manuelle, keramische Umstellung für druckunabhängige Funktion ■ mit Sicherheitseinrichtung ■ Durchflussrate 21 l/min bei 3 bar 	Concealed single lever wall tub and shower mixer ½", assembly set <ul style="list-style-type: none"> ■ manual, ceramic diverter tub/shower for pressure-independent function ■ with safety device ■ flow rate 21 l/min at 3 bar 	A	B	C	D	E
			849,-	1.099,-	1.176,-	1.223,-	1.506,-
			F	G	H	I	L
			1.398,-	1.176,-	1.443,-	1.627,-	1.934,-

Variante | Alternative

	615.20.135 1-Hand Wannenfüll- und Brausebatterie ½" für UP-Montage, Fertigmontageset <ul style="list-style-type: none"> ■ manuelle, keramische Umstellung für druckunabhängige Funktion ■ ohne Sicherheitseinrichtung ■ Durchflussrate 21 l/min bei 3 bar 	Concealed single lever wall tub and shower mixer ½", assembly set <ul style="list-style-type: none"> ■ manual, ceramic diverter tub/shower for pressure-independent function ■ without safety device ■ flow rate 21 l/min at 3 bar 	A	B	C	D	E
			829,-	1.079,-	1.156,-	1.199,-	1.486,-
			F	G	H	I	L
			1.378,-	1.156,-	1.423,-	1.608,-	1.914,-

Variante | Alternative

	615.20.235 1-Hand Brausebatterie ½" für UP-Montage, Fertigmontageset <ul style="list-style-type: none"> ■ ohne Umstellung ■ Funktionseinheit mit ker. Scheiben ■ Durchflussrate 20,4 l/min bei 3 bar 	Concealed single lever shower mixer ½", assembly set <ul style="list-style-type: none"> ■ without diverter ■ functional unit with ceramic discs ■ flow rate 20,4 l/min at 3 bar 	A	B	C	D	E
			659,-	792,-	959,-	994,-	1.254,-
			F	G	H	I	L
			1.142,-	959,-	1.198,-	1.369,-	1.534,-

Benötigt | Required

	649.40.360 Unterputz-Einbaubox ½" <ul style="list-style-type: none"> ■ zu Fertigmontageset 615.20.125, 615.20.135 und 615.20.235 ■ für Nass- und Trockenbau geeignet 	Concealed wall box ½" <ul style="list-style-type: none"> ■ for assembly set 615.20.125, 615.20.135 und 615.20.235 ■ for wetwall and drywall construction 	A				
			168,-				

Unterputz-Thermostate ½" | Wall thermostats, concealed ½"

	615.40.380 Unterputz-Thermostat ½" mit Mengenregulierung, Fertigmontageset <ul style="list-style-type: none"> ■ manuelle, keramische Umstellung Wanne/Brause, druckunabhängig ■ mit Sicherheitseinrichtung ■ Durchflussrate 20,4 l/min bei 3 bar 	Concealed wall thermostat ½" with flow control, assembly set <ul style="list-style-type: none"> ■ manual, ceramic diverter tub/shower for pressure-independent function ■ with safety device ■ flow rate 20,4 l/min at 3 bar 	A	B	C	D	E
			1.094,-	1.224,-	1.437,-	1.483,-	1.767,-
			F	G	H	I	L
			1.626,-	1.437,-	1.704,-	1.887,-	2.349,-

Benötigt | Required

	649.40.360 Unterputz-Einbaubox ½" <ul style="list-style-type: none"> ■ zu Fertigmontageset 615.40.380 ■ für Nass- und Trockenbau geeignet 	Concealed wall box ½" <ul style="list-style-type: none"> ■ for assembly set 615.40.380 ■ for wetwall and drywall construction 	A				
			168,-				

CHARLESTON ROYAL

Maßzeichnungen unter www.joerger.de - Menü SERVICE.
 Technical specifications under www.joerger.de - menu SERVICE.

A chrom chrome	[.000]	E platin matt platinum matt	[.066]
B silbernickel polished nickel	[.035]	F nerz matt mink matt	[.096]
C nerz mink	[.095]	G schwarz-matt black matt	[.092]
C nickel matt satin nickel	[.036]	G weiß-matt white matt	[.052]
D edelmessing sunshine	[.040]	H bronze bronze	[.011]
D platin platinum	[.065]	I gold gold	[.020]
E edelmess.matt sunshine matt	[.041]	L roségold rosegold	[.022]
E gold matt gold matt	[.021]	L roségold matt rosegold matt	[.023]

Variante | Alternative



615.40.360 Unterputz-Thermostat ½“
mit Mengenregulierung,
 Fertigmontageset

- ohne Umstellung
- mit integrierter keramischer Mengenregulierung
- Durchflussrate 20,4 l/min bei 3 bar

Concealed wall thermostat ½“
with flow control,
 assembly set

- without diverter
- with integrated ceramic cartridge for volume control
- flow rate 20,4 l/min at 3 bar

A	B	C	D	E
1.079,-	1.209,-	1.399,-	1.448,-	1.732,-
F	G	H	I	L
1.592,-	1.399,-	1.669,-	1.853,-	2.334,-

Variante | Alternative



615.40.460 Unterputz-Thermostat ½“
ohne Mengenregulierung,
 Fertigmontageset

- Funktionseinheit ohne Umstellung und ohne Absperrung
- Durchflussrate 25,8 l/min bei 3 bar

Concealed wall thermostat ½“
without flow control,
 assembly set

- Functional unit without diverter and without shut-off
- flow rate 25,8 l/min at 3 bar

A	B	C	D	E
898,-	1.028,-	1.192,-	1.226,-	1.486,-
F	G	H	I	L
1.368,-	1.192,-	1.434,-	1.679,-	2.153,-

Benötigt | Required



649.40.360 Unterputz-Einbaubox ½“

- zu Fertigmontageset 615.40.360, und 615.40.460
- für Nass- und Trockenbau geeignet

Concealed wall box ½“

- for assembly set 615.40.360, and 615.40.460
- for wetwall and drywall construction

A	B	C	D	E
168,-				

Unterputz-Thermostat ¾“ mit hohem Durchfluß | Wall thermostat, concealed ¾“ with high flow



615.40.555 Unterputz-Thermostat ¾“
ohne Mengenregulierung,
 Fertigmontageset

- serienbezogener Temperiergriff
- Sicherheitssperre bei 38° C

Concealed wall thermostat ¾“
without flow control,
 assembly set

- design handle for temp. control
- locking device at 38°C

A	B	C	D	E
586,-	686,-	748,-	795,-	1.064,-
F	G	H	I	L
952,-	626,-	779,-	1.239,-	1.858,-

Benötigt | Required



649.40.555 Unterputz-Einbaukörper ¾“

- zu Fertigmontageset 615.40.555
- Kartusche mit Schmutzfangsieben
- für Nass- und Trockenbau geeignet
- Durchflussrate 64,2 l/min bei 3 bar
- ohne Absperrung

Concealed thermostat body ¾“

- for assembly set 615.40.555
- cartridge with filter screens
- for wetwall and drywall construction
- flow rate 64,2 l/min at 3 bar
- without shut-off

A	B	C	D	E
1.636,-				

Unterputz-Thermostat ¾“ | Wall thermostat, concealed ¾“



615.40.520 Unterputz-Thermostat ¾“
ohne Mengenregulierung,
 Fertigmontageset

- serienbezogener Temperiergriff
- Sicherheitssperre bei 38° C

Concealed wall thermostat ¾“
without flow control,
 assembly set

- design handle for temp. control
- locking device at 38°C

A	B	C	D	E
586,-	686,-	748,-	795,-	1.064,-
F	G	H	I	L
952,-	626,-	779,-	1.239,-	1.858,-

Benötigt | Required



649.40.520 Unterputz-Einbaukörper ¾“

- zu Fertigmontageset 615.40.520
- Kartusche mit Schmutzfangsieben
- für Nass- und Trockenbau geeignet
- Durchflussrate 41 l/min bei 3 bar
- ohne Absperrung

Concealed thermostat body ¾“

- for assembly set 615.40.520
- cartridge with filter screens
- for wetwall and drywall construction
- flow rate 41 l/min at 3 bar
- without shut-off











A	B	C	D	E
498,-				

CHARLESTON ROYAL

Maßzeichnungen unter www.joerger.de - Menü SERVICE.
 Technical specifications under www.joerger.de - menu SERVICE.

A chrom chrome	[.000]	E platin matt platinum matt	[.066]
B silbernickel polished nickel	[.035]	F nerz matt milk matt	[.096]
C nerz milk	[.095]	G schwarz-matt black matt	[.092]
C nickel matt satin nickel	[.036]	G weiß-matt white matt	[.052]
D edelmessing sunshine	[.040]	H bronze bronze	[.011]
D platin platinum	[.065]	I gold gold	[.020]
E edelmess.matt sunshine matt	[.041]	L roségold rosegold	[.022]
E gold matt gold matt	[.021]	L roségold matt rosegold matt	[.023]

Unterputz-Thermostat/Ventil-Modul | Concealed thermostatic/wall-valve modul

			A	B	C	D	E	
	615.60.432	Unterputz-Ventil-Modul Fertigmontageset ■ Griff ■ Rosette	Concealed wall-valve-modul assembly set ■ design handle ■ escutcheon	222,-	247,-	274,-	308,-	399,-
	Benötigt Required			F	G	H	I	L
				372,-	342,-	434,-	465,-	635,-
	649.20.610	Unterputz-Ventil-Modul, 1-fach ■ 1x Spindelventil 3/4", rechtsschließend mit keram. Scheiben ■ 2 Abgänge 1/2", je 1x rechts/links möglich, gleichzeitig benutzbar	Concealed wall-valve-modul, single ■ 1x spindle valve 3/4", clockwise closure with ceramic discs ■ 2 outlets 1/2", each 1x right/left possible, simultaneously usable	A				
				229,-				
	649.20.620	Unterputz-Ventil-Modul, 2-fach ■ 2 Spindelventil 3/4", rechtsschließend mit keram. Scheiben ■ 4 Abgänge 1/2", je 2x rechts/links möglich, gleichzeitig benutzbar ■ im Verbund maßgenaue Montage ■ erweiterbar mit 649.20.610	Concealed wall-valve-modul, double ■ 2x spindle valve 3/4", clockwise closure with ceramic discs ■ 4 outlets 1/2", each 2x right/left possible, simultaneously usable ■ precise assembly due to composite ■ expandable with 649.20.610	A				
				458,-				
	649.20.630	Unterputz-Ventil-Modul, 3-fach ■ 3 Spindelventil 3/4", rechtsschließend mit keram. Scheiben ■ 6 Abgänge 1/2", je 3x rechts/links möglich, gleichzeitig benutzbar ■ im Verbund maßgenauen Montage ■ erweiterbar mit 649.20.610	Concealed wall-valve-modul, triple ■ 3x spindle valve 3/4", clockwise closure with ceramic discs ■ 6 outlets 1/2", each 3x right/left possible, simultaneously usable ■ precise assembly due to composite ■ expandable with 649.20.610	A				
				686,-				
	615.40.460	Unterputz-Thermostat 1/2" ohne Mengenregulierung, Fertigmontageset ■ Funktionseinheit ohne Umstellung und ohne Absperrung ■ Durchflußrate 25,8 l/min bei 3 bar	Concealed wall thermostat 1/2" without flow control, assembly set ■ Functional unit without diverter and without shut-off ■ flow rate 25,8 l/min at 3 bar	A	B	C	D	E
				898,-	1.028,-	1.192,-	1.226,-	1.486,-
				F	G	H	I	L
			1.368,-	1.192,-	1.434,-	1.679,-	2.153,-	
	649.20.612	Anschlußadapter 1/2" ■ Anschlußadapter, Abschlußstopfen ■ passend zu Einbaubox 649.40.360	Connection adapter 1/2" ■ connection adapter, end plug ■ matching to wall box 649.40.360	A				
				122,-				
	649.40.360	Unterputz-Einbaubox 1/2" ■ zu Fertigmontageset 615.40.460 ■ für Nass- und Trockenbau geeignet	Concealed wall box 1/2" ■ for assembly set 615.40.460 ■ for wetwall and drywall construction	A				
				168,-				
	615.40.555	Unterputz-Thermostat 3/4" ohne Mengenregulierung, Fertigmontageset ■ serienbezogener Temperiergriff ■ Sicherheitssperre bei 38° C	Concealed wall thermostat 3/4" without flow control, assembly set ■ design handle for temp. control ■ locking device at 38° C	A	B	C	D	E
				586,-	686,-	748,-	795,-	1.064,-
				F	G	H	I	L
			952,-	626,-	779,-	1.239,-	1.858,-	
	649.20.634	Anschlußadapter 3/4" ■ Anschlußadapter, Abschlußstopfen ■ passend zu Einbaukörper 649.40.555	Connection adapter 3/4" ■ connection adapter, end plug ■ matching to wall body 649.40.555	A				
				146,-				
	649.40.555	Unterputz-Einbaukörper 3/4" ■ zu Fertigmontageset 615.40.555 ■ Kartusche mit Schmutzfängsieben ■ für Nass- und Trockenbau geeignet ■ Durchflußrate 64,2 l/min bei 3 bar ■ ohne Absperrung	Concealed thermostat body 3/4" ■ for assembly set 615.40.555 ■ cartridge with filter screens ■ for wetwall and drywall construction ■ flow rate 64,2 l/min at 3 bar ■ without shut-off	A				
				1.636,-				

CHARLESTON ROYAL

Maßzeichnungen unter www.joerger.de - Menü SERVICE.
 Technical specifications under www.joerger.de - menu SERVICE.

A chrom chrome	[.000]	E platin matt platinum matt	[.066]
B silbernickel polished nickel	[.035]	F nerz matt milk matt	[.096]
C nerz milk	[.095]	G schwarz-matt black matt	[.092]
C nickel matt satin nickel	[.036]	G weiß-matt white matt	[.052]
D edelmessing sunshine	[.040]	H bronze bronze	[.011]
D platin platinum	[.065]	I gold gold	[.020]
E edelmess.matt sunshine matt	[.041]	L roségold rosegold	[.022]
E gold matt gold matt	[.021]	L roségold matt rosegold matt	[.023]

Unterputz-Umstellung und Ventile | Diverter and valves concealed

	615.40.650 Unterputz 3-Wege Umstellung ½" Fertigmontageset ■ Griff ■ Hülse, Schubrosette	Concealed 3-position diverter ½" assembly set ■ design handle ■ socket with adjustable escutcheon	A	B	C	D	E
			150,-	191,-	229,-	266,-	369,-
			F	G	H	I	L

Benötigt | Required

	649.40.600 Unterputz 3-Wege Umstellung ½" Einbaukörper ■ zu Fertigmontageset 615.40.650	Concealed 3-position diverter ½" diverter body ■ for assembly set 615.40.650	A				
			236,-				

	615.50.234 Unterputz-Ventil Fertigmontageset ■ Griff ■ Hülse, Schubrosette	Concealed wall valve assembly set ■ design handle ■ socket with adjustable escutcheon	A	B	C	D	E
			142,-	175,-	208,-	238,-	324,-
			F	G	H	I	L

Benötigt | Required

	649.20.350 Unterputz-Ventil ½", Einbaukörper ■ rechtsschließend, ker. Scheiben	Concealed wall valve ½", body ■ clockwise closure, ceramic discs	A				
			66,-				

	649.20.355 Unterputz-Ventil ½", Einbaukörper ■ linksschließend, ker. Scheiben	Concealed wall valve ½", body ■ counter-clockwise closure, cer. discs	A				
			66,-				

	649.20.450 Unterputz-Ventil ¾", Einbaukörper ■ rechtsschließend, ker. Scheiben	Concealed wall valve ¾", body ■ clockwise closure, ceramic discs	A				
			99,-				

	649.20.455 Unterputz-Ventil ¾", Einbaukörper ■ linksschließend, ker. Scheiben	Concealed wall valve ¾", body ■ counter-clockwise closure, cer. discs	A				
			99,-				

Brausen | Showers

	632.13.305 Duschgarnitur, komplett ■ Wandrohr 800 mm, mit Schieber ■ Metall-Handbrause mit Anti-Kalk-System und Rückflussverhinderer ■ Metall-Brauseschlauch 1750 mm, beidseitig mit drehbarem Konus	Shower bar set, complete ■ wall bar 800 mm, with slider ■ metal hand shower with anticalc. system and backflow preventer ■ metal shower hose 1750 mm, both sides with turning cone	A	B	C	D	E
			319,-	774,-	1.022,-	1.132,-	1.674,-
			F	G	H	I	L

	632.13.350 Duschstange, lose ■ Wandrohr 800 mm, mit Schieber	Shower bar, separate ■ wall bar 800 mm, with slider	A	B	C	D	E
			139,-	387,-	515,-	574,-	849,-
			F	G	H	I	L

	632.13.215 Schlauchbrausegarnitur ■ Wandanschlußbogen ½", Schubrosette ■ Wand-Brausehalter ■ Metall-Handbrause mit Anti-Kalk-System und Rückflussverhinderer ■ Metall-Brauseschlauch 1500 mm, beidseitig mit drehbarem Konus	Shower combination ■ wall elbow connection ½", escutcheon ■ wall fitting for hand shower ■ metal hand shower with anticalc. system and backflow preventer ■ metal shower hose 1500 mm, both sides with turning cone	A	B	C	D	E
			337,-	499,-	608,-	662,-	934,-
			F	G	H	I	L

CHARLESTON ROYAL

Maßzeichnungen unter www.joerger.de - Menü SERVICE.
 Technical specifications under www.joerger.de - menu SERVICE.

A chrom chrome	[.000]	E platin matt platinum matt	[.066]
B silbernickel polished nickel	[.035]	F nerz matt milk matt	[.096]
C nerz milk	[.095]	G schwarz-matt black matt	[.092]
C nickel matt satin nickel	[.036]	G weiß-matt white matt	[.052]
D edelmessing sunshine	[.040]	H bronze bronze	[.011]
D platin platinum	[.065]	I gold gold	[.020]
E edelmess.matt sunshine matt	[.041]	L roségold rosegold	[.022]
E gold matt gold matt	[.021]	L roségold matt rosegold matt	[.023]

	632.13.150 Wandanschlußbogen 1/2", ohne Haken ■ Brauseabgang 1/2" ■ mit Rückflussverhinderer, Rosette	Wall elbow connection 1/2", without cradle ■ discharge 1/2" ■ with backflow preventer, escutcheon	A	B	C	D	E
			89,-	98,-	106,-	112,-	178,-
			F	G	H	I	L
			152,-	148,-	187,-	239,-	306,-

	632.13.270 Wand-Brausehalter	Wall fitting for hand shower	A	B	C	D	E
			79,-	79,-	89,-	99,-	158,-
			F	G	H	I	L
			132,-	114,-	154,-	198,-	296,-

	619.13.237 Hygienebrausegarnitur ■ Wandbrausehalter und -anschlußbogen 1/2", Schubrosette ■ Hygienebrause, modern (649.13.337), komplett aus Metall ■ einstrahlig, Bedienung über Druckhebel ■ Metall-Brauseschlauch 1250 mm	Ablution spray combination ■ wall fitting and elbow connection 1/2" ■ spray handshower, modern (649.13.337), completely metal ■ one jet, push-lever operation ■ flexible metal shower hose 1250 mm	A	B	C	D	E
			271,-	436,-	489,-	569,-	668,-
			F	G	H	I	L
			629,-	659,-	994,-	1.169,-	1.532,-

	615.20.237 1-Hand Batterie 1/2" für Hygiene-Brause, Fertigmontageset ■ Rosette, Griff	Concealed single lever 1/2" for ablution spray, assembly set ■ escutcheon, handle	A	B	C	D	E
			271,-	359,-	439,-	496,-	580,-
			F	G	H	I	L
			549,-	439,-	526,-	658,-	729,-

Benötigt | Required

	649.20.237 Unterputz 1-Hand Batterie 1/2", Einbaukörper ■ Kartusche mit keramischen Scheiben ■ zu Fertigmontageset 615.20.237	Single lever mixer 1/2", concealed body ■ cartridge with ceramic discs ■ for assembly set 615.20.237	A	B	C	D	E
			125,-	169,-	208,-	229,-	268,-
			F	G	H	I	L
			249,-	224,-	258,-	329,-	396,-

	649.13.885 Regenbrause 1/2", ø 300 mm ■ Ausführung ganz in Metall ■ 3 mm ultra flach ■ mit Kugelgelenk ■ Anti-Kalk-System ■ weitere, zur Serie passende Kopfbrausen siehe Kapitel "Brausen"	Rain shower head 1/2", ø 300 mm ■ full metal body ■ 3 mm ultra-thin ■ with ball joint ■ with anticalcareous system ■ for further shower heads matching this collection see chapter "showers"	A	B	C	D	E
			168,-	359,-	618,-	708,-	1.049,-
			F	G	H	I	L
			899,-	589,-	968,-	1.599,-	2.196,-

Empfohlen | Recommended

	649.13.755 Wandarm 1/2" ■ Ausladung 350 mm ■ weitere, zur Serie passende Wandarme siehe Kapitel "Brausen"	Wall bracket 1/2" ■ projection 350 mm ■ for further wall brackets matching this collection see chapter "showers"	A	B	C	D	E
			129,-	288,-	316,-	349,-	439,-
			F	G	H	I	L
			399,-	288,-	328,-	479,-	539,-

CHARLESTON ROYAL

Maßzeichnungen unter www.joerger.de - Menü SERVICE.
 Technical specifications under www.joerger.de - menu SERVICE.

A chrom chrome	[.000]	E platin matt platinum matt	[.066]
B silbernickel polished nickel	[.035]	F nerz matt milk matt	[.096]
C nerz milk	[.095]	G schwarz-matt black matt	[.092]
C nickel matt satin nickel	[.036]	G weiß-matt white matt	[.052]
D edelmessing sunshine	[.040]	H bronze bronze	[.011]
D platin platinum	[.065]	I gold gold	[.020]
E edelmess.matt sunshine matt	[.041]	L roségold rosegold	[.022]
E gold matt gold matt	[.021]	L roségold matt rosegold matt	[.023]



- 649.13.519** Seitenbrause ½"
- Rosette ø 130 mm, Wandmontage
 - Brausekopf schwenkbar, 20°
 - Anti-Kalk-System
 - Material: Kunststoff
- weitere, zur Serie passende Seitenbrausen siehe Kapitel "Brausen"

- Body spray side shower ½"**
- escutcheon ø 130 mm, wall assembly
 - swivel shower head, 20°
 - anticalcareous system
 - plastic
- for further side showers matching this collection see chapter "showers"

A	B	C	D	E
167,-	326,-	385,-	399,-	542,-
F	G	H	I	L
496,-	376,-	472,-	634,-	949,-



- 649.13.381** Handbrause ½"
- Anti-Kalk-System
 - 3 Strahlarten: Normal, Soft, Schwall
 - Anschluß ½"
 - Ausführung ABS
- weitere, zur Serie passende Handbrausen siehe Kapitel "Brausen"

- Hand shower ½"**
- anticalcareous system
 - with 3 jets: normal, soft, cascade
 - connection ½"
 - material ABS
- for further hand showers matching this collection see chapter "showers"

A	B	C	D	E
69,-	172,-	259,-	299,-	476,-
F	G	H	I	L
392,-	289,-	449,-	668,-	869,-



- 649.13.391** Handbrause ½"
- Anti-Kalk-System
 - Anschluß ½"
 - Ausführung Metall
- weitere, zur Serie passende Handbrausen siehe Kapitel "Brausen"

- Hand shower ½"**
- anticalcareous system
 - connection ½"
 - material metal
- for further hand showers matching this collection see chapter "showers"









A	B	C	D	E
208,-	398,-	426,-	464,-	578,-
F	G	H	I	L
546,-	394,-	586,-	718,-	956,-

CHARLESTON ROYAL

A chrom chrome	[.000]	E platin matt platinum matt	[.066]
B silbernickel polished nickel	[.035]	F nerz matt mink matt	[.096]
C nerz mink	[.095]	G schwarz-matt black matt	[.092]
C nickel matt satin nickel	[.036]	G weiß-matt white matt	[.052]
D edelmessing sunshine	[.040]	H bronze bronze	[.011]
D platin platinum	[.065]	I gold gold	[.020]
E edelmess.matt sunshine matt	[.041]	L roségold rosegold	[.022]
E gold matt gold matt	[.021]	L roségold matt rosegold matt	[.023]

Maßzeichnungen unter www.joerger.de - Menü SERVICE.
 Technical specifications under www.joerger.de - menu SERVICE.

Accessoires für Handtücher | Accessories for towels

		A	B	C	D	E
 <p>632.00.002 Handtuchhalter ■ Rohre beweglich, ca. 400 mm</p>	<p>Towel bar ■ swivel bars, approx. 400 mm</p>	89,-	249,-	378,-	464,-	718,-
		F	G	H	I	L
		612,-	329,-	464,-	829,-	969,-
 <p>632.00.004 Handtuchhalter ■ Rohr starr, ca. 400 mm</p>	<p>Towel bar ■ rigid bar, approx. 400 mm</p>	69,-	198,-	234,-	256,-	324,-
		F	G	H	I	L
		292,-	245,-	342,-	464,-	728,-
 <p>632.00.047 Handtuchring</p>	<p>Towel ring</p>	75,-	225,-	399,-	433,-	572,-
		F	G	H	I	L
		506,-	238,-	326,-	679,-	784,-
 <p>632.00.022 Handtuchhaken</p>	<p>Robe hanger</p>	25,-	45,-	62,-	99,-	129,-
		F	G	H	I	L
		116,-	86,-	128,-	146,-	199,-
 <p>632.00.040 Badetuchhalter ■ ca. 800 mm</p>	<p>Bath towel bar ■ approx. 800 mm</p>	87,-	248,-	334,-	408,-	596,-
		F	G	H	I	L
		512,-	299,-	584,-	759,-	1.399,-
 <p>632.00.041 Badetuchhalter, doppelt ■ ca. 600 mm</p>	<p>Bath towel bar, double ■ approx. 600 mm</p>	118,-	422,-	594,-	742,-	1.084,-
		F	G	H	I	L
		928,-	482,-	846,-	1.474,-	1.996,-
 <p>632.00.048 Badetuch-Ablage ■ ca. 600 x 260 mm</p>	<p>Bath towel shelf ■ approx. 600 x 260 mm</p>	187,-	536,-	886,-	1.069,-	1.649,-
		F	G	H	I	L
		1.389,-	608,-	1.335,-	1.842,-	2.678,-
 <p>632.00.031 Wannengriff ■ ca. 300 mm</p>	<p>Tub handle ■ approx. 300 mm</p>	76,-	212,-	309,-	342,-	512,-
		F	G	H	I	L
		436,-	278,-	426,-	609,-	862,-

CHARLESTON ROYAL

Maßzeichnungen unter www.joerger.de - Menü SERVICE.
 Technical specifications under www.joerger.de - menu SERVICE.

A chrom chrome	[.000]	E platin matt platinum matt	[.066]
B silbernickel polished nickel	[.035]	F nerz matt milk matt	[.096]
C nerz milk	[.095]	G schwarz-matt black matt	[.092]
C nickel matt satin nickel	[.036]	G weiß-matt white matt	[.052]
D edelmessing sunshine	[.040]	H bronze bronze	[.011]
D platin platinum	[.065]	I gold gold	[.020]
E edelmess.matt sunshine matt	[.041]	L roségold rosegold	[.022]
E gold matt gold matt	[.021]	L roségold matt rosegold matt	[.023]

	634.00.104 Gästehandtuchkorb, eckig ■ mit Ablage ■ Korbgröße 260 x 150 x 190 mm	Guest towel basket, angular ■ with shelf ■ basket size 260 x 150 x 190 mm	A	B	C	D	E
			230,-	314,-	356,-	389,-	528,-
			F	G	H	I	L
			466,-	492,-	675,-	849,-	1.499,-

Accessoires für Waschplatz | Accessories for washstands

	632.00.007 Seifenhalter, komplett ■ Wandmodell ■ Seifenschale aus Kristallglas	Soap dish holder, complete ■ wall version ■ crystal glass dish	A	B	C	D	E
			49,-	94,-	154,-	226,-	293,-
			F	G	H	I	L
			258,-	152,-	229,-	318,-	369,-

732.00.307 Seifenschale, lose	Glass dish, separate	A				
		19,-				

	632.00.017 Seifenhalter, komplett ■ Standmodell ■ Seifenschale aus Kristallglas	Soap dish holder, complete ■ free standing version ■ crystal glass dish	A	B	C	D	E
			44,-	84,-	108,-	169,-	215,-
			F	G	H	I	L
			189,-	179,-	214,-	279,-	369,-

	632.00.005 Lotionspender, komplett ■ Wandmodell ■ Einfache Befüllung von oben ■ Betätigung von unten ■ Dosiermenge: 0,5 ml/Hub	Soap dispenser, complete ■ wall version ■ easy filling from above ■ actuation from below ■ dosage: 0.5 ml / stroke	A	B	C	D	E
			116,-	179,-	219,-	254,-	359,-
			F	G	H	I	L
			289,-	268,-	356,-	468,-	728,-

	632.00.016 Lotionspender, komplett ■ Standmodell ■ Ausführung Metall	Soap dispenser, complete ■ free standing version ■ brass	A	B	C	D	E
			67,-	169,-	272,-	335,-	534,-
			F	G	H	I	L
			446,-	308,-	484,-	738,-	989,-

	634.00.105 Schwammkorb ■ rechteckig, 260 x 130 mm	Sponge basket ■ rectangular, 260 x 130 mm	A	B	C	D	E
			199,-	238,-	279,-	332,-	462,-
			F	G	H	I	L
			396,-	348,-	459,-	589,-	859,-

CHARLESTON ROYAL

A chrom chrome	[.000]	E platin matt platinum matt	[.066]
B silbernickel polished nickel	[.035]	F nerz matt milk matt	[.096]
C nerz milk	[.095]	G schwarz-matt black matt	[.092]
C nickel matt satin nickel	[.036]	G weiß-matt white matt	[.052]
D edelmessing sunshine	[.040]	H bronze bronze	[.011]
D platin platinum	[.065]	I gold gold	[.020]
E edelmess.matt sunshine matt	[.041]	L roségold rosegold	[.022]
E gold matt gold matt	[.021]	L roségold matt rosegold matt	[.023]

Maßzeichnungen unter www.joerger.de - Menü SERVICE.
 Technical specifications under www.joerger.de - menu SERVICE.

	634.00.106 Eckschwammkorb ■ 195 x 195 mm	Corner sponge basket ■ 195 x 195 mm	A	B	C	D	E
			195,-	234,-	275,-	328,-	458,-
			F	G	H	I	L
			390,-	344,-	455,-	585,-	855,-

	632.00.036 Glashalter, komplett ■ Wandmodell ■ Glas aus Kristallglas, seidenmatt	Tumbler holder, complete ■ wall version ■ crystal glass tumbler, frosted	A	B	C	D	E
			54,-	99,-	159,-	232,-	298,-
			F	G	H	I	L
			262,-	158,-	234,-	322,-	374,-

	732.00.336 Mundglas, seidenmatt, lose	Glass tumbler, frosted, separate	A				
			19,-				

	632.00.046 Glashalter, komplett ■ Standmodell ■ Glas aus Kristallglas, seidenmatt	Tumbler holder, complete ■ free standing version ■ crystal glass tumbler, frosted	A	B	C	D	E
			49,-	89,-	114,-	174,-	219,-
			F	G	H	I	L
			194,-	184,-	218,-	284,-	374,-

Accessoires für WC-Bereich | Accessories for w.c. area

	632.00.014 Papierhalter ■ beweglicher Bügel	Toilet paper roll holder ■ mobile bracket	A	B	C	D	E
			79,-	149,-	208,-	247,-	313,-
			F	G	H	I	L
			286,-	274,-	459,-	576,-	946,-

	632.00.015 Reserve-Papierhalter	Spare toilet paper roll holder	A	B	C	D	E
			39,-	78,-	119,-	138,-	182,-
			F	G	H	I	L
			159,-	132,-	246,-	318,-	489,-

	632.00.000 Klosettbürstengarnitur, komplett ■ wandhängendes Modell ■ Glas aus Kristallglas, seidenmatt	Toilet brush holder set, complete ■ suspended model ■ crystal glass, frosted	A	B	C	D	E
			86,-	139,-	198,-	257,-	323,-
			F	G	H	I	L
			292,-	248,-	399,-	549,-	728,-

	799.00.300 Bürstenglas, lose	Glass, separate	A				
			48,-				

	799.00.237 Bürstenkopf, lose	Brush, separate	A				
			22,-				

CHARLESTON ROYAL

Maßzeichnungen unter www.joerger.de - Menü SERVICE.
 Technical specifications under www.joerger.de - menu SERVICE.

A chrom chrome	[.000]	E platin matt platinum matt	[.066]
B silbernickel polished nickel	[.035]	F nerz matt milk matt	[.096]
C nerz milk	[.095]	G schwarz-matt black matt	[.092]
C nickel matt satin nickel	[.036]	G weiß-matt white matt	[.052]
D edelmessing sunshine	[.040]	H bronze bronze	[.011]
D platin platinum	[.065]	I gold gold	[.020]
E edelmess.matt sunshine matt	[.041]	L roségold rosegold	[.022]
E gold matt gold matt	[.021]	L roségold matt rosegold matt	[.023]



632.00.001 Klosettbürstengarnitur, komplett
 ■ stehendes Modell
 ■ Bürstentopf aus Metall

Toilet brush holder set, complete
 ■ floor standing model
 ■ brush holder out of brass

A	B	C	D	E
118,-	189,-	249,-	294,-	389,-
F	G	H	I	L
328,-	426,-	668,-	749,-	1.279,-

Spiegel | Mirrors



649.00.414 Kosmetikspiegel, beleuchtet
 ■ schwenk- und ausziehbar
 ■ 3-fache Vergrößerung
 ■ Direktanschluss
 ■ Spiegeldurchmesser 185 mm
 ■ Rahmendurchmesser 250 mm
 ■ Kalt-, Warm- und Taglicht durch Piezzo-Schalter umschaltbar

Cosmetic mirror, incl. lighting
 ■ swivelling and extendable
 ■ magnification 3:1
 ■ direct connection
 ■ mirror diameter 185 mm
 ■ frame diameter 250 mm
 ■ cold, warm and day light switchable by Piezzo switch

A	B	C	D	E
556,-	988,-	1.214,-	1.418,-	1.828,-
F	G	H	I	L
1.684,-	1.214,-	1.549,-	2.138,-	2.998,-



CHARLESTON SQUARE



Oberflächen | colours

Folgende Oberflächen sind bei dieser Serie möglich |
The following colours are possible with this collection

chrom		chrome	[.000]	PG A
silbernickel		polished nickel	[.035]	PG B
nerz		mink	[.095]	PG C
nickel matt		satin nickel	[.036]	PG C
edelmessing		sunshine	[.040]	PG D
platin		platinum	[.065]	PG D
edelmessing matt		sunshine matt	[.041]	PG E
gold matt		gold matt	[.021]	PG E
platin matt		platinum matt	[.066]	PG E
nerz matt		mink matt	[.096]	PG F
schwarz matt		black matt	[.092]	PG G
weiß matt		white matt	[.052]	PG G
bronze		bronze	[.011]	PG H
gold		gold	[.020]	PG I
roségold		rosegold	[.022]	PG L
roségold matt		rosegold matt	[.023]	PG L

Andere Oberflächen auf Anfrage |
Different colours on request

Auf Anfrage können wir Produkte von Drittanbietern auch gerne passend zu unseren Oberflächen veredeln (vorbehaltlich der Eignungsprüfung) | Third-party products may be plated matching to our colours on request (subject to valuation of suitability)

Waschtisch | Washbasin

ab Seite | from page 054

Bidet | Bidet

ab Seite | from page 056

Wanne | Bath tub

ab Seite | from page 057

Dusche | Shower

ab Seite | from page 058

Accessoires | Accessories

ab Seite | from page 064

CHARLESTON SQUARE

Maßzeichnungen unter www.joerger.de - Menü SERVICE.
 Technical specifications under www.joerger.de - menu SERVICE.

A chrom chrome	[.000]	E platin matt platinum matt	[.066]
B silbernickel polished nickel	[.035]	F nerz matt milk matt	[.096]
C nerz milk	[.095]	G schwarz-matt black matt	[.092]
C nickel matt satin nickel	[.036]	G weiß-matt white matt	[.052]
D edelmessing sunshine	[.040]	H bronze bronze	[.011]
D platin platinum	[.065]	I gold gold	[.020]
E edelmess.matt sunshine matt	[.041]	L roségold rosegold	[.022]
E gold matt gold matt	[.021]	L roségold matt rosegold matt	[.023]

Waschtisch Batterien | Washbasin mixer

	634.30.300 Waschtisch 3-Loch Batterie ½“ <ul style="list-style-type: none"> ■ Ausladung 150 mm; Höhe 270 mm ■ Auslauf schwenkbar ■ mit keramischen Oberteilen ½“ ■ Exzenter-Ablaufgarnitur 1 ¼“ ■ empfohlen: 2x 649.15.530 - Kupferrohr 300 mm 	Washbasin 3-hole mixer ½“ <ul style="list-style-type: none"> ■ spout projection 150 mm; height 270 mm; swivelling spout ■ ceramic internal upper parts ½“ ■ pop-up waste 1 ¼“ ■ recommended: 2x 649.15.530 - copper tube 300 mm 	A	B	C	D	E	
			899,-	1.126,-	1.250,-	1.399,-	1.638,-	
			F	G	H	I	L	
			1.485,-	1.321,-	1.589,-	1.869,-	2.749,-	

	634.10.333 Waschtisch 1-Hand Batterie <ul style="list-style-type: none"> ■ Ausladung 150 mm; Höhe 290 mm ■ Auslauf schwenkbar ■ Kartusche mit keramischen Scheiben ■ Exzenter-Ablaufgarnitur 1 ¼“ ■ 2 Kupferrohre M10x1 x 400 mm 	Single lever washbasin mixer <ul style="list-style-type: none"> ■ spout projection 150 mm; height 290 mm; swivelling spout ■ cartridge with ceramic discs ■ pop-up waste 1 ¼“ ■ 2 copper tubes M10x1 x 400 mm 	A	B	C	D	E	
			519,-	772,-	863,-	961,-	1.190,-	
			F	G	H	I	L	
			1.074,-	1.079,-	1.368,-	1.350,-	2.523,-	

Variante | Alternative

	634.10.334 Waschtisch 1-Hand Batterie <ul style="list-style-type: none"> ■ ohne Exzenter-Ablaufgarnitur 	Single lever washbasin mixer <ul style="list-style-type: none"> ■ without pop-up waste 	A	B	C	D	E	
			508,-	667,-	750,-	916,-	1.123,-	
			F	G	H	I	L	
			976,-	915,-	1.124,-	1.289,-	1.949,-	

	634.10.353 Waschtisch 1-Hand Batterie, XXL <ul style="list-style-type: none"> ■ Ausladung 240 mm; Höhe 290 mm ■ Auslauf schwenkbar ■ Kartusche mit keramischen Scheiben ■ Exzenter-Ablaufgarnitur 1 ¼“ ■ 2 Kupferrohre M10x1 x 400 mm 	Single lever washbasin mixer, XXL <ul style="list-style-type: none"> ■ spout projection 240 mm; height 290 mm; swivelling spout ■ cartridge with ceramic discs ■ pop-up waste 1 ¼“ ■ 2 copper tubes M10x1 x 400 mm 	A	B	C	D	E	
			538,-	836,-	962,-	1.028,-	1.360,-	
			F	G	H	I	L	
			1.217,-	1.094,-	1.378,-	1.512,-	2.538,-	

Variante | Alternative

	634.10.354 Waschtisch 1-Hand Batterie, XXL <ul style="list-style-type: none"> ■ ohne Exzenter-Ablaufgarnitur 	Single lever washbasin mixer, XXL <ul style="list-style-type: none"> ■ without pop-up waste 	A	B	C	D	E	
			514,-	735,-	821,-	947,-	1.160,-	
			F	G	H	I	L	
			1.022,-	901,-	1.112,-	1.330,-	2.039,-	

	634.10.854 Waschtisch 1-Hand Batterie <ul style="list-style-type: none"> ■ für freistehende Montage ■ Ausladung 220 mm ■ Auslauf schwenkbar ■ ohne Ablaufgarnitur ■ Standrohr mit Befestigungsflansch ■ Luftsprudler ■ Kartusche mit keramischen Scheiben ■ Höhe gesamt 1147 - 1227 mm ■ Höhe bis Luftsprudler 1032 - 1112 mm 	Single lever washbasin mixer <ul style="list-style-type: none"> ■ free standing assembly ■ spout projection 220 mm ■ swivelling spout ■ without waste ■ Pillar tube with flange ■ aerator ■ ceramic internal upper part ■ height 1147 - 1227 mm ■ aerator height 1032 - 1112 mm 	A	B	C	D	E	
			1.499,-	2.126,-	2.702,-	2.826,-	3.681,-	
			F	G	H	I	L	
			2.974,-	2.595,-	3.168,-	4.327,-	4.976,-	

Benötigt | Required

	649.10.970 Bausatz-Vormontage <ul style="list-style-type: none"> ■ Bodenplatte mit Befestigungsset ■ zu Fertigmontageset 634.10.834 und 634.10.854 	Assembly set for pre-installation <ul style="list-style-type: none"> ■ joint plate with fixing set ■ for assembly set 634.10.834 and 634.10.854 	A				
			549,-				

CHARLESTON SQUARE

Maßzeichnungen unter www.joerger.de - Menü SERVICE.
 Technical specifications under www.joerger.de - menu SERVICE.

A chrom chrome	[.000]	E platin matt platinum matt	[.066]
B silbernickel polished nickel	[.035]	F nerz matt milk matt	[.096]
C nerz milk	[.095]	G schwarz-matt black matt	[.092]
C nickel matt satin nickel	[.036]	G weiß-matt white matt	[.052]
D edelmessing sunshine	[.040]	H bronze bronze	[.011]
D platin platinum	[.065]	I gold gold	[.020]
E edelmess.matt sunshine matt	[.041]	L roségold rosegold	[.022]
E gold matt gold matt	[.021]	L roségold matt rosegold matt	[.023]



- 634.10.222 Handwaschbecken 1-Hand Batterie**
- Ausladung 85 mm; Höhe 230 mm
 - Auslauf schwenkbar
 - Kartusche mit keramischen Scheiben
 - Exzenter-Ablaufgarnitur 1 ¼"
 - 2 Kupferrohre M10x1 x 400 mm
- Single lever mini washbasin mixer**
- spout projection 85 mm; height 230 mm; swivelling spout
 - cartridge with ceramic discs
 - pop-up waste 1 ¼"
 - 2 copper tubes M10x1 x 400 mm

A	B	C	D	E
599,-	838,-	968,-	1.170,-	1.424,-
F	G	H	I	L
1.279,-	1.155,-	1.442,-	1.628,-	2.599,-

Variante | Alternative

- 634.10.224 Handwaschbecken 1-Hand Batterie**
- ohne Exzenter-Ablaufgarnitur
- Single lever mini washbasin mixer**
- without pop-up waste



A	B	C	D	E
549,-	708,-	892,-	1.077,-	1.308,-
F	G	H	I	L
1.149,-	991,-	1.192,-	1.498,-	2.019,-

Wand-Waschtisch 1-Hand Batterien | Single lever wall-washbasin mixer



- 634.20.360 Wand-Waschtisch 1-Hand Batterie ½", Fertigmontageset**
- Wand-Auslauf
 - Ausladung 207 - 222 mm
 - Kartusche mit keramischen Scheiben, Wandrosette
- Single lever wall washbasin mixer ½", assembly set**
- wall spout
 - projection 207 - 222 mm
 - cartridge with ceramic discs
 - escutcheon

A	B	C	D	E
528,-	672,-	952,-	1.069,-	1.259,-
F	G	H	I	L
1.198,-	1.000,-	1.256,-	1.529,-	2.468,-

Benötigt | Required



- 649.20.362 Wand-Waschtisch 1-Hand Batterie ½", Einbaukörper**
- **Bedienhebel rechts**
 - zu Fertigmontageset 634.20.360
 - Kartusche mit ker. Scheiben
- Single lever wall washbasin mixer ½", concealed body**
- **control lever on the right**
 - for assembly set 634.20.360
 - cartridge with ceramic discs

A	B	C	D	E
258,-				



- 649.20.364 Wand-Waschtisch 1-Hand Batterie ½", Einbaukörper**
- **Bedienhebel links**
 - zu Fertigmontageset 634.20.360
 - Kartusche mit ker. Scheiben
- Single lever wall washbasin mixer ½", concealed body**
- **control lever on the left**
 - for assembly set 634.20.360
 - cartridge with ceramic discs

A	B	C	D	E
258,-				

Wand-Waschtisch Batterien | Wall-Washbasin mixer



- 634.30.360 Wand-Waschtisch 3-Loch Batterie, Fertigmontageset**
- Wand-Auslauf, Ausladung 200 - 212 mm
 - Griff, Hülse, Schubrosette
 - Oberteile ½", keramische Scheiben
- Wall washbasin 3-hole mixer, assembly set**
- wall spout, projection 200 - 212 mm
 - design handle, socket with adjustable escutcheon
 - cartridges ½", with ceramic discs

A	B	C	D	E
629,-	768,-	967,-	1.088,-	1.282,-
F	G	H	I	L
1.178,-	1.076,-	1.326,-	1.556,-	2.538,-

Variante | Alternative

- 634.30.365 Wand-Waschtisch 3-Loch Batterie XXL, Fertigmontageset**
- Ausladung 270 - 282 mm
- Wall washbasin 3-hole mixer XXL, assembly set**
- projection 270 - 282 mm

A	B	C	D	E
642,-	781,-	995,-	1.118,-	1.319,-
F	G	H	I	L
1.208,-	1.087,-	1.336,-	1.598,-	2.548,-

Benötigt | Required



- 649.30.380 Wand-Waschtisch 3-Loch Batterie, Einbaukörper ½"**
- 2 Anschlüsse, Stichmaß 204 mm
 - zu Fertigmontageset 634.30.360 und 634.30.365
- Wall washbasin 3-hole mixer concealed body ½"**
- 2 connections, center dist. 204 mm
 - for assembly set 634.30.360 and 634.30.365

A	B	C	D	E
296,-				

CHARLESTON SQUARE

Maßzeichnungen unter www.joerger.de - Menü SERVICE.
 Technical specifications under www.joerger.de - menu SERVICE.

A chrom chrome	[.000]	E platin matt platinum matt	[.066]
B silbernickel polished nickel	[.035]	F nerz matt mink matt	[.096]
C nerz mink	[.095]	G schwarz-matt black matt	[.092]
C nickel matt satin nickel	[.036]	G weiß-matt white matt	[.052]
D edelmessing sunshine	[.040]	H bronze bronze	[.011]
D platin platinum	[.065]	I gold gold	[.020]
E edelmess.matt sunshine matt	[.041]	L roségold rosegold	[.022]
E gold matt gold matt	[.021]	L roségold matt rosegold matt	[.023]

Bidet Batterien | Bidet mixer



634.10.111 Bidet 1-Hand Batterie

- Ausladung 115 mm; Höhe 150 mm
- Kartusche mit keramischen Scheiben
- Exzenter-Ablaufgarnitur 1 ¼"
- 2 Druckschläuche M10x1 x 450 mm

Single lever bidet mixer

- spout projection 115 mm; height 150 mm
- cartridge with ceramic discs
- pop-up waste 1 ¼"
- 2 pressure hoses M10x1 x 450 mm

A	B	C	D	E
614,-	721,-	1.016,-	1.144,-	1.402,-
F	G	H	I	L
1.236,-	1.034,-	1.264,-	1.606,-	2.459,-

Zubehör für Waschtisch- und Bidet-Batterien | Supplies for washbasin and bidet mixer



626.12.100 Eckventil ½"

- Ausladung 110 mm
- Fettkammer-Innenoberteil ½"
- Quetschverschraubung
- Schubrosette

Angle valve ½"

- projection 110 mm
- cartridge ½"
- compression joint
- escutcheon

A	B	C	D	E
145,-	196,-	248,-	296,-	448,-
F	G	H	I	L
392,-	265,-	424,-	529,-	698,-



649.15.530 Kupferrohr, 300 mm

- mit Bördel, für Quetschverschraubung

Copper tube, 300 mm

- with flange, for compression joint

A	B	C	D	E
15,-	38,-	55,-	62,-	74,-
F	G	H	I	L
69,-	75,-	94,-	112,-	169,-

Variante | Alternative

649.15.550 Kupferrohr, 500 mm

- mit Bördel, für Quetschverschraubung

Copper tube, 500 mm

- with flange, for compression joint



A	B	C	D	E
20,-	58,-	77,-	87,-	102,-
F	G	H	I	L
97,-	77,-	96,-	134,-	219,-



649.15.334 Waschtisch-Tassensiphon 1 ¼"

- schwere Ausführung
- Rosette
- Abgangsrohr ø 32 mm
- Tauchrohrlänge 165 mm

Washbasin cupped siphon trap 1 ¼"

- heavy brass
- escutcheon
- outlet tube ø 32 mm
- dip pipe 165 mm

A	B	C	D	E
195,-	316,-	460,-	520,-	780,-
F	G	H	I	L
671,-	359,-	514,-	896,-	998,-



649.15.270 Zwangsablaufventil

- Schaftlänge 70 mm
- für Waschbecken ohne Überlauf

Restraint drain/waste

- lenght of shaft 70 mm
- for washbasins without overflow

A	B	C	D	E
68,-	129,-	185,-	239,-	312,-
F	G	H	I	L
299,-	176,-	394,-	429,-	582,-

649.15.271 Zwangsablaufventil

- Schaftlänge 100 mm
- für Waschbecken ohne Überlauf

Restraint drain/waste

- lenght of shaft 100 mm
- for washbasins without overflow

A	B	C	D	E
72,-	138,-	196,-	254,-	329,-
F	G	H	I	L
318,-	186,-	418,-	454,-	616,-



649.15.290 Zwangsablaufventil

- Schaftlänge 70 mm
- für Waschbecken ohne Überlauf

Restraint drain/waste

- lenght of shaft 70 mm
- for washbasins without overflow

A	B	C	D	E
93,-	116,-	172,-	192,-	255,-
F	G	H	I	L
224,-	247,-	414,-	464,-	612,-

CHARLESTON SQUARE

Maßzeichnungen unter www.joerger.de - Menü SERVICE.
 Technical specifications under www.joerger.de - menu SERVICE.

A chrom chrome	[.000]	E platin matt platinum matt	[.066]
B silbernickel polished nickel	[.035]	F nerz matt milk matt	[.096]
C nerz milk	[.095]	G schwarz-matt black matt	[.092]
C nickel matt satin nickel	[.036]	G weiß-matt white matt	[.052]
D edelmessing sunshine	[.040]	H bronze bronze	[.011]
D platin platinum	[.065]	I gold gold	[.020]
E edelmess.matt sunshine matt	[.041]	L roségold rosegold	[.022]
E gold matt gold matt	[.021]	L roségold matt rosegold matt	[.023]



649.10.086 Rohrverlängerung, Höhe 150 mm
 ■ Durchmesser 42 mm
 ■ für 6634.10.222, 634.10.224, 634.10.300, 634.10.333, 634.10.334, 634.10.350, 634.10.353, 634.10.354, 634.10.600

Body extension, height 150 mm
 ■ diameter 42 mm
 ■ for 634.10.222, 634.10.224, 634.10.300, 634.10.333, 634.10.334, 634.10.350, 634.10.353, 634.10.354, 634.10.600

A	B	C	D	E
224,-	328,-	360,-	398,-	486,-
F	G	H	I	L
440,-	456,-	592,-	549,-	1.068,-

Badewanne, Stand-Batterien | Bath tub mixer sets, deck mount



634.40.105 4-Loch Wannenfüll- und Brausebatterie 1/2", für Standmontage
 ■ Ausladung 220 mm; Höhe 290 mm
 ■ 2 Seitenrandventile mit keramischen Oberteilen 1/2"
 ■ Metall-Brauseschlauch 2000 mm
 ■ Metall-Handbrause mit Anti-Kalk-System und Rückflussverhinderer

Tub/shower mixer set 1/2" deck mount
 ■ spout projection 220 mm; height 290 mm
 ■ 2 side valves, 1/2" cer. internal upper parts, metal shower hose 2000 mm
 ■ metal hand shower with anticalc. system and backflow preventer

A	B	C	D	E
1.479,-	1.938,-	2.156,-	2.290,-	2.572,-
F	G	H	I	L
2.442,-	1.974,-	2.592,-	2.812,-	3.584,-

Variante | Alternative



634.40.155 4-Loch Wannenrandkombination 1/2"
 ■ für Ab- und Überlaufgarnitur mit Wanneneinlauf, ohne Rohrunterbrecher
 ■ Seitenrandventile, 2-Wege Umstellung
 ■ Metall-Brauseschlauch 2000 mm
 ■ Metall-Handbrause mit Anti-Kalk-System und Rückflussverhinderer

tub/shower combination 1/2"
 ■ for waste and overflow set with bath tub filler spout, without pipe interrupter
 ■ side valves, 2-position diverter
 ■ metal shower hose 2000 mm
 ■ metal hand shower with anticalc. system and backflow preventer

A	B	C	D	E
1.269,-	1.589,-	1.714,-	1.889,-	2.134,-
F	G	H	I	L
2.039,-	1.756,-	2.324,-	2.342,-	3.248,-

Empfohlen | Recommended



649.40.160 Montageplatte, komplett
 ■ für 4-Loch Armaturen
 ■ Druckschläuche 1/2" x 1/2" x 600 mm
 ■ empfohlen: Schlauchkastensystem siehe Kapitel "Serienübergreifendes"

Assembly plate, complete
 ■ for deck mounted tub/shower mixer
 ■ pressure hoses 1/2"x 1/2" x 600 mm
 ■ recommended: system with hose box see chapter "universal products"

A	B	C	D	E
308,-				



634.10.825 Wannen 1-Hand Batterie
 ■ für freistehende Montage
 ■ Ausladung 355 mm
 ■ Auslauf schwenkbar
 ■ Umstellung Wanne/Brause
 ■ Metall-Handbrause mit Anti-Kalk-System und Rückflussverhinderer
 ■ Metall-Brauseschlauch 1500 mm
 ■ Standrohr mit Befestigungsflansch
 ■ Luftsprudler
 ■ Kartusche mit keramischen Scheiben
 ■ Höhe gesamt 940 - 1020 mm
 ■ Höhe bis Luftsprudler 765 - 845 mm

Tub/shower mixer set
 ■ free standing assembly
 ■ spout projection 355 mm
 ■ swivelling spout
 ■ diverter spout/hand shower
 ■ metal hand shower with anticalc. system and backflow preventer
 ■ metal shower hose 1500 mm
 ■ Pillar tube with flange
 ■ aerator
 ■ ceramic internal upper part
 ■ height 940 - 1020 mm
 ■ aerator height 765 - 845 mm

A	B	C	D	E
2.198,-	3.118,-	3.629,-	3.998,-	4.965,-
F	G	H	I	L
4.549,-	3.149,-	3.966,-	5.518,-	6.098,-

Benötigt | Required

649.10.970 Bausatz-Vormontage
 ■ Bodenplatte mit Befestigungsset
 ■ zu Fertigmontageset 634.10.820



Assembly set for pre-installation
 ■ joint plate with fixing set
 ■ for assembly set 634.10.820

A	B	C	D	E
549,-				

CHARLESTON SQUARE

Maßzeichnungen unter www.joerger.de - Menü SERVICE.
 Technical specifications under www.joerger.de - menu SERVICE.

A chrom chrome	[.000]	E platin matt platinum matt	[.066]
B silbernickel polished nickel	[.035]	F nerz matt mink matt	[.096]
C nerz mink	[.095]	G schwarz-matt black matt	[.092]
C nickel matt satin nickel	[.036]	G weiß-matt white matt	[.052]
D edelmessing sunshine	[.040]	H bronze bronze	[.011]
D platin platinum	[.065]	I gold gold	[.020]
E edelmess.matt sunshine matt	[.041]	L roségold rosegold	[.022]
E gold matt gold matt	[.021]	L roségold matt rosegold matt	[.023]

Badewanne, Aufputz-Batterien | Bath tub mixer sets, exposed

	634.20.505 1-Hand Aufputz-Wannenfüll- und Brausebatterie ½", mit Garnitur <ul style="list-style-type: none"> ■ Ausladung 192 mm ■ Metall-Handbrause mit Anti-Kalk-System und Rückflussverhinderer ■ Metall-Brauseschlauch 1500 mm, beidseitig mit drehbarem Konus 	Single lever exposed tub/shower mixer ½", incl. shower set <ul style="list-style-type: none"> ■ spout projection 192 mm ■ metal hand shower with anticalc. system and backflow preventer ■ metal shower hose 1500 mm, both sides with turning cone 	A	B	C	D	E	
				999,-	1.554,-	1.994,-	2.224,-	2.990,-
				F	G	H	I	L
			2.644,-	1.563,-	2.819,-	3.299,-	3.582,-	

Variante | Alternative

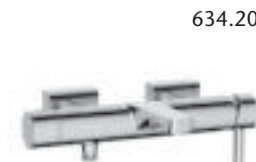
	634.20.515 1-Hand Aufputz-Wannenfüll- und Brausebatterie ½", ohne Garnitur <ul style="list-style-type: none"> ■ Ausladung 192 mm ■ Kartusche mit keramischen Scheiben 	Single lever exposed tub/shower mixer ½", without shower set <ul style="list-style-type: none"> ■ spout projection 192 mm ■ cartridge with ceramic discs 	A	B	C	D	E	
				669,-	1.149,-	1.478,-	1.699,-	2.458,-
				F	G	H	I	L
			2.158,-	1.182,-	2.289,-	2.729,-	2.972,-	

	634.11.100 Wand-Wanneneinlauf ¾" <ul style="list-style-type: none"> ■ Ausladung 214 - 226 mm ■ Steckanschluß-Montage 	Tub wall spout ¾" <ul style="list-style-type: none"> ■ spout projection 214 - 226 mm ■ special concealed wall attachment 	A	B	C	D	E	
				315,-	392,-	499,-	566,-	661,-
				F	G	H	I	L
			612,-	491,-	594,-	774,-	998,-	

634.20.415 – Aufputz Set mit Steigrohr | Exposed set with shower system

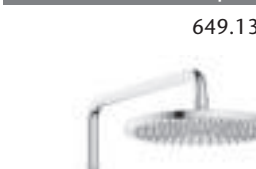
	649.13.844 Regenbrause ½", ø 240 mm <ul style="list-style-type: none"> ■ Ausführung ganz in Metall ■ 3 mm ultra flach ■ mit Kugelgelenk ■ Anti-Kalk-System 	Rain shower head ½", ø 240 mm <ul style="list-style-type: none"> ■ full metal body ■ 3 mm ultra-thin ■ with ball joint ■ with anticalcareous system 	A	B	C	D	E	
				499,-	1.098,-	1.289,-	1.372,-	1.622,-
				F	G	H	I	L
			1.452,-	1.289,-	1.599,-	1.927,-	2.529,-	

	649.20.260 Steigrohr, Umstellung, Wandarm <ul style="list-style-type: none"> ■ zum Anschluß an die Brausebatterie ■ Ausladung 390 - 410 mm ■ in der Neigung und Höhe verstellbare Brausehalterung 	Supply pipe, diverter, wall bracket <ul style="list-style-type: none"> ■ to connect the exposed shower mixer ■ projection 390 - 410 mm ■ fitting for handshower adjustable in height and inclination 	A	B	C	D	E	
				398,-	669,-	838,-	996,-	1.276,-
				F	G	H	I	L
			1.122,-	1.182,-	1.520,-	1.736,-	2.399,-	

	632.13.705 Brausegarnitur <ul style="list-style-type: none"> ■ Metall-Handbrause mit Anti-Kalk-System und Rückflussverhinderer ■ Metall-Brauseschlauch 1500 mm, beidseitig mit drehbarem Konus 	Shower combination <ul style="list-style-type: none"> ■ metal hand shower with anticalc. system and backflow preventer ■ metal shower hose 1500 mm, both sides with turning cone 	A	B	C	D	E	
				279,-	499,-	546,-	648,-	796,-
				F	G	H	I	L
			784,-	598,-	896,-	1.138,-	1.379,-	

	634.20.615 Aufputz-Brausebatterie ½" <ul style="list-style-type: none"> ■ für Steigrohr ■ Brauseabgang ¾" 	Exposed shower mixer ½" <ul style="list-style-type: none"> ■ for supply pipe ■ discharge ¾" 	A	B	C	D	E	
				565,-	918,-	1.132,-	1.279,-	1.919,-
				F	G	H	I	L
			1.618,-	1.042,-	1.723,-	2.116,-	2.618,-	

Dusche, Aufputz-Batterien | Shower mixer sets, exposed

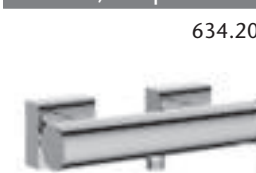
	634.20.605 1-Hand Brausebatterie ½" für Aufputzmontage <ul style="list-style-type: none"> ■ Kartusche mit keramischen Scheiben ■ Brauseabgang ½" ■ verdeckte S-Anschlüsse ½" x ¾" 	Single lever exposed shower mixer ½" <ul style="list-style-type: none"> ■ cartridge with ceramic discs ■ discharge ½" ■ concealed S-connections ½" x ¾" 	A	B	C	D	E	
				556,-	823,-	1.019,-	1.109,-	1.499,-
				F	G	H	I	L
			1.334,-	987,-	1.345,-	1.878,-	2.496,-	

CHARLESTON SQUARE

Maßzeichnungen unter www.joerger.de - Menü SERVICE.
 Technical specifications under www.joerger.de - menu SERVICE.

A chrom chrome	[.000]	E platin matt platinum matt	[.066]
B silbernickel polished nickel	[.035]	F nerz matt milk matt	[.096]
C nerz milk	[.095]	G schwarz-matt black matt	[.092]
C nickel matt satin nickel	[.036]	G weiß-matt white matt	[.052]
D edelmessing sunshine	[.040]	H bronze bronze	[.011]
D platin platinum	[.065]	I gold gold	[.020]
E edelmess.matt sunshine matt	[.041]	L roségold rosegold	[.022]
E gold matt gold matt	[.021]	L roségold matt rosegold matt	[.023]

634.20.465 – Aufputz Set mit Steigrohr | Exposed set with shower system

	649.13.844 Regenbrause 1/2", ø 240 mm	Rain shower head 1/2", ø 240 mm	A	B	C	D	E	
	<ul style="list-style-type: none"> ■ Ausführung ganz in Metall ■ 3 mm ultra flach ■ mit Kugelgelenk ■ Anti-Kalk-System 	<ul style="list-style-type: none"> ■ full metal body ■ 3 mm ultra-thin ■ with ball joint ■ with anticalcareous system 	499,-	1.098,-	1.289,-	1.372,-	1.622,-	
			F	G	H	I	L	
			1.452,-	1.289,-	1.599,-	1.927,-	2.529,-	
		649.20.260 Steigrohr, Umstellung, Wandarm	Supply pipe, diverter, wall bracket	A	B	C	D	E
<ul style="list-style-type: none"> ■ zum Anschluß an die Brausebatterie ■ Ausladung 390 - 410 mm ■ in der Neigung und Höhe verstellbare Brausehalterung 		<ul style="list-style-type: none"> ■ to connect the exposed shower mixer ■ projection 390 - 410 mm ■ fitting for handshower adjustable in height and inclination 	398,-	669,-	838,-	996,-	1.276,-	
		F	G	H	I	L		
		1.122,-	1.182,-	1.520,-	1.736,-	2.399,-		
		632.13.705 Brausegarnitur	Shower combination	A	B	C	D	E
<ul style="list-style-type: none"> ■ Metall-Handbrause mit Anti-Kalk-System und Rückflussverhinderer ■ Metall-Brauseschlauch 1500 mm, beidseitig mit drehbarem Konus 		<ul style="list-style-type: none"> ■ metal hand shower with anticalc. system and backflow preventer ■ metal shower hose 1500 mm, both sides with turning cone 	279,-	499,-	546,-	648,-	796,-	
		F	G	H	I	L		
		784,-	598,-	896,-	1.138,-	1.379,-		
		634.20.265 Aufputz-Brausethermostat 1/2"	Exposed shower thermostat 1/2"	A	B	C	D	E
<ul style="list-style-type: none"> ■ für Steigrohr ■ Brauseabgang 3/4" 		<ul style="list-style-type: none"> ■ for supply pipe ■ discharge 3/4" 	629,-	938,-	1.162,-	1.359,-	1.899,-	
		F	G	H	I	L		
		1.614,-	1.086,-	1.608,-	2.229,-	2.869,-		

Unterputz-Hebelmischer 1/2" | Concealed single lever mixer 1/2"





	634.20.125 1-Hand Wannenfüll- und Brausebatterie 1/2" für UP-Montage, Fertigmontageset	Concealed single lever wall tub and shower mixer 1/2", assembly set	A	B	C	D	E
	<ul style="list-style-type: none"> ■ manuelle, keramische Umstellung für druckunabhängige Funktion ■ <u>mit</u> Sicherheitseinrichtung ■ Durchflussrate 21 l/min bei 3 bar 	<ul style="list-style-type: none"> ■ manual, ceramic diverter tub/shower for pressure-independent function ■ <u>with</u> safety device ■ flow rate 21 l/min at 3 bar 	866,-	1.119,-	1.208,-	1.254,-	1.538,-
		F	G	H	I	L	
		1.426,-	1.208,-	1.474,-	1.658,-	1.974,-	
		Variante Alternative					
	634.20.135 1-Hand Wannenfüll- und Brausebatterie 1/2" für UP-Montage, Fertigmontageset	Concealed single lever wall tub and shower mixer 1/2", assembly set	A	B	C	D	E
	<ul style="list-style-type: none"> ■ manuelle, keramische Umstellung für druckunabhängige Funktion ■ <u>ohne</u> Sicherheitseinrichtung ■ Durchflussrate 21 l/min bei 3 bar 	<ul style="list-style-type: none"> ■ manual, ceramic diverter tub/shower for pressure-independent function ■ <u>without</u> safety device ■ flow rate 21 l/min at 3 bar 	968,-	1.099,-	1.188,-	1.234,-	1.518,-
		F	G	H	I	L	
		1.406,-	1.188,-	1.454,-	1.638,-	1.954,-	
		Variante Alternative					
	634.20.235 1-Hand Brausebatterie 1/2" für UP-Montage, Fertigmontageset	Concealed single lever shower mixer 1/2", assembly set	A	B	C	D	E
	<ul style="list-style-type: none"> ■ <u>ohne</u> Umstellung ■ Funktionseinheit mit ker. Scheiben ■ Durchflussrate 20,4 l/min bei 3 bar 	<ul style="list-style-type: none"> ■ <u>without</u> diverter ■ functional unit with ceramic discs ■ flow rate 20,4 l/min at 3 bar 	672,-	808,-	986,-	1.022,-	1.282,-
		F	G	H	I	L	
		1.165,-	986,-	1.229,-	1.396,-	1.588,-	
		Benötigt Required					
	649.40.360 Unterputz-Einbaubox 1/2"	Concealed wall box 1/2"	A				
	<ul style="list-style-type: none"> ■ zu Fertigmontageset 634.20.125, 634.20.135 und 634.20.235 ■ für Nass- und Trockenbau geeignet 	<ul style="list-style-type: none"> ■ for assembly set 634.20.125, 634.20.135 und 634.20.235 ■ for wetwall and drywall construction 	168,-				

CHARLESTON SQUARE



Maßzeichnungen unter www.joerger.de - Menü SERVICE.
 Technical specifications under www.joerger.de - menu SERVICE.

A chrom chrome	[.000]	E platin matt platinum matt	[.066]
B silbernickel polished nickel	[.035]	F nerz matt mink matt	[.096]
C nerz mink	[.095]	G schwarz-matt black matt	[.092]
C nickel matt satin nickel	[.036]	G weiß-matt white matt	[.052]
D edelmessing sunshine	[.040]	H bronze bronze	[.011]
D platin platinum	[.065]	I gold gold	[.020]
E edelmess.matt sunshine matt	[.041]	L roségold rosegold	[.022]
E gold matt gold matt	[.021]	L roségold matt rosegold matt	[.023]



Unterputz-Thermostate 1/2" | Wall thermostats, concealed 1/2"

	634.40.380 Unterputz-Thermostat 1/2" <u>mit</u> Mengenregulierung, Fertigmontageset <ul style="list-style-type: none"> manuelle, keramische Umstellung Wanne/Brause, druckunabhängig mit Sicherheitseinrichtung Durchflussrate 20,4 l/min bei 3 bar 	Concealed wall thermostat 1/2" <u>with</u> flow control, assembly set <ul style="list-style-type: none"> manual, ceramic diverter tub/shower for pressure-independent function with safety device flow rate 20,4 l/min at 3 bar 	A	B	C	D	E
			1.127,-	1.262,-	1.467,-	1.514,-	1.820,-
	634.40.360 Unterputz-Thermostat 1/2" <u>mit</u> Mengenregulierung, Fertigmontageset <ul style="list-style-type: none"> ohne Umstellung mit integrierter keramischer Mengenregulierung Durchflussrate 20,4 l/min bei 3 bar 	Concealed wall thermostat 1/2" <u>with</u> flow control, assembly set <ul style="list-style-type: none"> without diverter with integrated ceramic cartridge for volume control flow rate 20,4 l/min at 3 bar 	A	B	C	D	E
			1.112,-	1.247,-	1.432,-	1.479,-	1.785,-
	634.40.460 Unterputz-Thermostat 1/2" <u>ohne</u> Mengenregulierung, Fertigmontageset <ul style="list-style-type: none"> Funktionseinheit <u>ohne</u> Umstellung und <u>ohne</u> Absperrung Durchflussrate 25,8 l/min bei 3 bar 	Concealed wall thermostat 1/2" <u>without</u> flow control, assembly set <ul style="list-style-type: none"> Functional unit <u>without</u> diverter and <u>without</u> shut-off flow rate 25,8 l/min at 3 bar 	A	B	C	D	E
			925,-	1.059,-	1.256,-	1.299,-	1.586,-
Variante Alternative							
	649.40.360 Unterputz-Einbaubox 1/2" <ul style="list-style-type: none"> zu Fertigmontageset 634.40.360, 634.40.380 und 634.40.460 für Nass- und Trockenbau geeignet 	Concealed wall box 1/2" <ul style="list-style-type: none"> for assembly set 634.40.360, 634.40.380 and 634.40.460 for wetwall and drywall construction 	A				
			168,-				

Unterputz-Thermostat 3/4" mit hohem Durchfluß | Wall thermostat, concealed 3/4" with high flow

	634.40.555 Unterputz-Thermostat 3/4" <u>ohne</u> Mengenregulierung, Fertigmontageset <ul style="list-style-type: none"> serienbezogener Temperiergriff Sicherheitssperre bei 38° C 	Concealed wall thermostat 3/4" <u>without</u> flow control, assembly set <ul style="list-style-type: none"> design handle for temp. control locking device at 38°C 	A	B	C	D	E
			608,-	762,-	824,-	872,-	1.139,-
	649.40.555 Unterputz-Einbaukörper 3/4" <ul style="list-style-type: none"> zu Fertigmontageset 634.40.555 Kartusche mit Schmutzfangsieben für Nass- und Trockenbau geeignet Durchflussrate 64,2 l/min bei 3 bar ohne Absperrung 	Concealed thermostat body 3/4" <ul style="list-style-type: none"> for assembly set 634.40.555 cartridge with filter screens for wetwall and drywall construction flow rate 64,2 l/min at 3 bar without shut-off 	A				
			1.636,-				

Unterputz-Thermostat 3/4" | Wall thermostat, concealed 3/4"











	634.40.520 Unterputz-Thermostat 3/4" <u>ohne</u> Mengenregulierung, Fertigmontageset <ul style="list-style-type: none"> serienbezogener Temperiergriff Sicherheitssperre bei 38° C 	Concealed wall thermostat 3/4" <u>without</u> flow control, assembly set <ul style="list-style-type: none"> design handle for temp. control locking device at 38°C 	A	B	C	D	E
			608,-	762,-	824,-	872,-	1.139,-
	649.40.520 Unterputz-Einbaukörper 3/4" <ul style="list-style-type: none"> zu Fertigmontageset 634.40.520 Kartusche mit Schmutzfangsieben für Nass- und Trockenbau geeignet Durchflussrate 41 l/min bei 3 bar ohne Absperrung 	Concealed thermostat body 3/4" <ul style="list-style-type: none"> for assembly set 634.40.520 cartridge with filter screens for wetwall and drywall construction flow rate 41 l/min at 3 bar without shut-off 	A				
			498,-				

CHARLESTON SQUARE

Maßzeichnungen unter www.joerger.de - Menü SERVICE.
 Technical specifications under www.joerger.de - menu SERVICE.

A chrom chrome	[.000]	E platin matt platinum matt	[.066]
B silbernickel polished nickel	[.035]	F nerz matt milk matt	[.096]
C nerz milk	[.095]	G schwarz-matt black matt	[.092]
C nickel matt satin nickel	[.036]	G weiß-matt white matt	[.052]
D edelmessing sunshine	[.040]	H bronze bronze	[.011]
D platin platinum	[.065]	I gold gold	[.020]
E edelmess.matt sunshine matt	[.041]	L roségold rosegold	[.022]
E gold matt gold matt	[.021]	L roségold matt rosegold matt	[.023]

Unterputz-Thermostat/Ventil-Modul | Concealed thermostatic/wall-valve modul

		A	B	C	D	E	
	634.60.432 Unterputz-Ventil-Modul Fertigmontageset ■ Griff ■ Rosette	Concealed wall-valve-modul assembly set ■ design handle ■ escutcheon	254,-	279,-	306,-	339,-	432,-
	Benötigt Required		F	G	H	I	L
			405,-	374,-	466,-	498,-	668,-
	649.20.610 Unterputz-Ventil-Modul, 1-fach ■ 1x Spindelventil 3/4", rechtsschließend mit keram. Scheiben ■ 2 Abgänge 1/2", je 1x rechts/links möglich, gleichzeitig benutzbar	Concealed wall-valve-modul, single ■ 1x spindle valve 3/4", clockwise closure with ceramic discs ■ 2 outlets 1/2", each 1x right/left possible, simultaneously usable	A				
			229,-				
	649.20.620 Unterputz-Ventil-Modul, 2-fach ■ 2 Spindelventil 3/4", rechtsschließend mit keram. Scheiben ■ 4 Abgänge 1/2", je 2x rechts/links möglich, gleichzeitig benutzbar ■ im Verbund maßgenaue Montage ■ erweiterbar mit 649.20.610	Concealed wall-valve-modul, double ■ 2x spindle valve 3/4", clockwise closure with ceramic discs ■ 4 outlets 1/2", each 2x right/left possible, simultaneously usable ■ precise assembly due to composite ■ expandable with 649.20.610	A				
			458,-				
	649.20.630 Unterputz-Ventil-Modul, 3-fach ■ 3 Spindelventil 3/4", rechtsschließend mit keram. Scheiben ■ 6 Abgänge 1/2", je 3x rechts/links möglich, gleichzeitig benutzbar ■ im Verbund maßgenauen Montage ■ erweiterbar mit 649.20.610	Concealed wall-valve-modul, triple ■ 3x spindle valve 3/4", clockwise closure with ceramic discs ■ 6 outlets 1/2", each 3x right/left possible, simultaneously usable ■ precise assembly due to composite ■ expandable with 649.20.610	A				
			686,-				
	634.40.460 Unterputz-Thermostat 1/2" <u>ohne</u> Mengenregulierung, Fertigmontageset ■ Funktionseinheit <u>ohne</u> Umstellung und <u>ohne</u> Absperrung ■ Durchflussrate 25,8 l/min bei 3 bar	Concealed wall thermostat 1/2" <u>without</u> flow control, assembly set ■ Functional unit <u>without</u> diverter and <u>without</u> shut-off ■ flow rate 25,8 l/min at 3 bar	A	B	C	D	E
			925,-	1.059,-	1.256,-	1.299,-	1.586,-
			F	G	H	I	L
		1.409,-	1.288,-	1.523,-	1.792,-	2.218,-	
	649.20.612 Anschlußadapter 1/2" ■ Anschlußadapter, Abschlußstopfen ■ passend zu Einbaubox 649.40.360	Connection adapter 1/2" ■ connection adapter, end plug ■ matching to wall box 649.40.360	A				
			122,-				
	649.40.360 Unterputz-Einbaubox 1/2" ■ zu Fertigmontageset 634.40.460 ■ für Nass- und Trockenbau geeignet	Concealed wall box 1/2" ■ for assembly set 634.40.460 ■ for wetwall and drywall construction	A				
			168,-				
	634.40.555 Unterputz-Thermostat 3/4" <u>ohne</u> Mengenregulierung, Fertigmontageset ■ serienbezogener Temperiergriff ■ Sicherheitssperre bei 38° C	Concealed wall thermostat 3/4" <u>without</u> flow control, assembly set ■ design handle for temp. control ■ locking device at 38° C	A	B	C	D	E
			608,-	762,-	824,-	872,-	1.139,-
			F	G	H	I	L
		1.028,-	708,-	854,-	1.314,-	1.932,-	
	649.20.634 Anschlußadapter 3/4" ■ Anschlußadapter, Abschlußstopfen ■ passend zu Einbaukörper 649.40.555	Connection adapter 3/4" ■ connection adapter, end plug ■ matching to wall body 649.40.555	A				
			146,-				
	649.40.555 Unterputz-Einbaukörper 3/4" ■ zu Fertigmontageset 634.40.555 ■ Kartusche mit Schmutzfangsieben ■ für Nass- und Trockenbau geeignet ■ Durchflussrate 64,2 l/min bei 3 bar ■ <u>ohne</u> Absperrung	Concealed thermostat body 3/4" ■ for assembly set 634.40.555 ■ cartridge with filter screens ■ for wetwall and drywall construction ■ flow rate 64,2 l/min at 3 bar ■ <u>without</u> shut-off	A				
			1.636,-				

CHARLESTON SQUARE

Maßzeichnungen unter www.joerger.de - Menü SERVICE.
 Technical specifications under www.joerger.de - menu SERVICE.

A chrom chrome	[.000]	E platin matt platinum matt	[.066]
B silbernickel polished nickel	[.035]	F nerz matt milk matt	[.096]
C nerz milk	[.095]	G schwarz-matt black matt	[.092]
C nickel matt satin nickel	[.036]	G weiß-matt white matt	[.052]
D edelmessing sunshine	[.040]	H bronze bronze	[.011]
D platin platinum	[.065]	I gold gold	[.020]
E edelmess.matt sunshine matt	[.041]	L roségold rosegold	[.022]
E gold matt gold matt	[.021]	L roségold matt rosegold matt	[.023]

Unterputz-Umstellung und Ventile | Diverter and valves concealed



634.40.650	Unterputz 3-Wege Umstellung 1/2" Fertigmontageset	<ul style="list-style-type: none"> Griff Hülse, Schubrosette 	Concealed 3-position diverter 1/2" assembly set	<ul style="list-style-type: none"> design handle socket with adjustable escutcheon 	A	B	C	D	E
					182,-	224,-	262,-	298,-	399,-

Benötigt | Required



649.40.600	Unterputz 3-Wege Umstellung 1/2" Einbaukörper	<ul style="list-style-type: none"> zu Fertigmontageset 634.40.650 	Concealed 3-position diverter 1/2" diverter body	<ul style="list-style-type: none"> for assembly set 634.40.650 	A				
					236,-				

Unterputz-Ventile | Valves concealed



634.50.234	Unterputz-Ventil Fertigmontageset	<ul style="list-style-type: none"> Griff Hülse, Schubrosette 	Concealed wall valve assembly set	<ul style="list-style-type: none"> design handle socket with adjustable escutcheon 	A	B	C	D	E
					174,-	208,-	239,-	269,-	356,-

Benötigt | Required



649.20.350	Unterputz-Ventil 1/2", Einbaukörper	<ul style="list-style-type: none"> rechtsschließend, ker. Scheiben 	Concealed wall valve 1/2", body	<ul style="list-style-type: none"> clockwise closure, ceramic discs 	A				
					66,-				



649.20.355	Unterputz-Ventil 1/2", Einbaukörper	<ul style="list-style-type: none"> linksschließend, ker. Scheiben 	Concealed wall valve 1/2", body	<ul style="list-style-type: none"> counter-clockwise closure, cer. discs 					

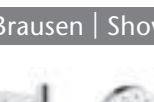

649.20.450	Unterputz-Ventil 3/4", Einbaukörper	<ul style="list-style-type: none"> rechtsschließend, ker. Scheiben 	Concealed wall valve 3/4", body	<ul style="list-style-type: none"> clockwise closure, ceramic discs 	A				
					99,-				



649.20.455	Unterputz-Ventil 3/4", Einbaukörper	<ul style="list-style-type: none"> linksschließend, ker. Scheiben 	Concealed wall valve 3/4", body	<ul style="list-style-type: none"> counter-clockwise closure, cer. discs 					

Brausen | Showers



634.13.305	Duschgarnitur, komplett	<ul style="list-style-type: none"> Wandrohr 800 mm, mit Schieber Handbrause mit Rückflussverhinderer Brauseschlauch 1750 mm, beidseitig mit drehbarem Konus 	Shower bar set, complete	<ul style="list-style-type: none"> wall bar 800 mm, with slider hand shower with backflow preventer metal shower hose 1750 mm, both sides with turning cone 	A	B	C	D	E
					626,-	1.056,-	1.249,-	1.398,-	1.936,-

634.13.350	Duschstange, lose	<ul style="list-style-type: none"> Wandrohr 800 mm, mit Schieber 	Shower bar, separate	<ul style="list-style-type: none"> wall bar 800 mm, with slider 	A	B	C	D	E
					546,-	667,-	717,-	751,-	944,-



634.13.215	Schlauchbrausegarnitur	<ul style="list-style-type: none"> Wandanschlußbogen 1/2", Schubrosette Wand-Brausehalter Metall-Handbrause mit Anti-Kalk-System und Rückflussverhinderer Metall-Brauseschlauch 1500 mm, beidseitig mit drehbarem Konus 	Shower combination	<ul style="list-style-type: none"> wall elbow connection 1/2", escutcheon wall fitting for hand shower metal hand shower with anticalc. system and backflow preventer metal shower hose 1500 mm, both sides with turning cone 	A	B	C	D	E
					344,-	509,-	629,-	689,-	954,-



634.13.150	Wandanschlußbogen 1/2", ohne Haken	<ul style="list-style-type: none"> Brauseabgang 1/2" mit Rückflussverhinderer, Rosette 	Wall elbow connection 1/2", without cradle	<ul style="list-style-type: none"> discharge 1/2" with backflow preventer, escutcheon 	A	B	C	D	E
					99,-	135,-	160,-	182,-	222,-

					F	G	H	I	L
					206,-	160,-	198,-	262,-	316,-

CHARLESTON SQUARE

Maßzeichnungen unter www.joerger.de - Menü SERVICE.
 Technical specifications under www.joerger.de - menu SERVICE.

A chrom chrome	[.000]	E platin matt platinum matt	[.066]
B silbernickel polished nickel	[.035]	F nerz matt milk matt	[.096]
C nerz milk	[.095]	G schwarz-matt black matt	[.092]
C nickel matt satin nickel	[.036]	G weiß-matt white matt	[.052]
D edelmessing sunshine	[.040]	H bronze bronze	[.011]
D platin platinum	[.065]	I gold gold	[.020]
E edelmess.matt sunshine matt	[.041]	L roségold rosegold	[.022]
E gold matt gold matt	[.021]	L roségold matt rosegold matt	[.023]

	649.13.230 Wand-Brausehalter	Wall fitting for hand shower	<table border="1"> <thead> <tr><th>A</th><th>B</th><th>C</th><th>D</th><th>E</th></tr> </thead> <tbody> <tr><td>146,-</td><td>195,-</td><td>220,-</td><td>229,-</td><td>279,-</td></tr> <tr><th>F</th><th>G</th><th>H</th><th>I</th><th>L</th></tr> <tr><td>264,-</td><td>220,-</td><td>273,-</td><td>328,-</td><td>392,-</td></tr> </tbody> </table>	A	B	C	D	E	146,-	195,-	220,-	229,-	279,-	F	G	H	I	L	264,-	220,-	273,-	328,-	392,-
A	B	C	D	E																			
146,-	195,-	220,-	229,-	279,-																			
F	G	H	I	L																			
264,-	220,-	273,-	328,-	392,-																			
	634.13.237 Hygienebrausegarnitur <ul style="list-style-type: none"> Wandbrausehalter und -anschlußbogen 1/2", Schubrosette Hygienebrause, modern (649.13.337), komplett aus Metall einstrahlig, Bedienung über Druckhebel Metall-Brauseschlauch 1250 mm 	Ablution spray combination <ul style="list-style-type: none"> wall fitting and elbow connection 1/2" spray handshower, modern (649.13.337), completely metal one jet, push-lever operation flexible metal shower hose 1250 mm 	<table border="1"> <thead> <tr><th>A</th><th>B</th><th>C</th><th>D</th><th>E</th></tr> </thead> <tbody> <tr><td>298,-</td><td>445,-</td><td>499,-</td><td>579,-</td><td>682,-</td></tr> <tr><th>F</th><th>G</th><th>H</th><th>I</th><th>L</th></tr> <tr><td>642,-</td><td>672,-</td><td>1.014,-</td><td>1.192,-</td><td>1.564,-</td></tr> </tbody> </table>	A	B	C	D	E	298,-	445,-	499,-	579,-	682,-	F	G	H	I	L	642,-	672,-	1.014,-	1.192,-	1.564,-
A	B	C	D	E																			
298,-	445,-	499,-	579,-	682,-																			
F	G	H	I	L																			
642,-	672,-	1.014,-	1.192,-	1.564,-																			
	634.20.237 1-Hand Batterie 1/2" für Hygiene-Brause, Fertigmontageset <ul style="list-style-type: none"> Rosette, Griff 	Concealed single lever 1/2" for ablution spray, assembly set <ul style="list-style-type: none"> escutcheon, handle 	<table border="1"> <thead> <tr><th>A</th><th>B</th><th>C</th><th>D</th><th>E</th></tr> </thead> <tbody> <tr><td>285,-</td><td>378,-</td><td>462,-</td><td>522,-</td><td>609,-</td></tr> <tr><th>F</th><th>G</th><th>H</th><th>I</th><th>L</th></tr> <tr><td>576,-</td><td>462,-</td><td>552,-</td><td>692,-</td><td>765,-</td></tr> </tbody> </table>	A	B	C	D	E	285,-	378,-	462,-	522,-	609,-	F	G	H	I	L	576,-	462,-	552,-	692,-	765,-
A	B	C	D	E																			
285,-	378,-	462,-	522,-	609,-																			
F	G	H	I	L																			
576,-	462,-	552,-	692,-	765,-																			
Benötigt Required																							
	649.20.237 Unterputz 1-Hand Batterie 1/2", Einbaukörper <ul style="list-style-type: none"> Kartusche mit keramischen Scheiben zu Fertigmontageset 634.20.237 	Single lever mixer 1/2", concealed body <ul style="list-style-type: none"> cartridge with ceramic discs for assembly set 634.20.237 	<table border="1"> <thead> <tr><th>A</th><th>B</th><th>C</th><th>D</th><th>E</th></tr> </thead> <tbody> <tr><td>125,-</td><td>169,-</td><td>208,-</td><td>229,-</td><td>268,-</td></tr> <tr><th>F</th><th>G</th><th>H</th><th>I</th><th>L</th></tr> <tr><td>249,-</td><td>224,-</td><td>258,-</td><td>329,-</td><td>396,-</td></tr> </tbody> </table>	A	B	C	D	E	125,-	169,-	208,-	229,-	268,-	F	G	H	I	L	249,-	224,-	258,-	329,-	396,-
A	B	C	D	E																			
125,-	169,-	208,-	229,-	268,-																			
F	G	H	I	L																			
249,-	224,-	258,-	329,-	396,-																			
	649.13.845 Regenbrause 1/2", ø 300 mm <ul style="list-style-type: none"> Ausführung ganz in Metall 3 mm ultra flach mit Kugelgelenk Anti-Kalk-System weitere, zur Serie passende Kopfbrausen siehe Kapitel "Brausen" 	Rain shower head 1/2", ø 300 mm <ul style="list-style-type: none"> full metal body 3 mm ultra-thin with ball joint with anticalcareous system for further shower heads matching this collection see chapter "showers" 	<table border="1"> <thead> <tr><th>A</th><th>B</th><th>C</th><th>D</th><th>E</th></tr> </thead> <tbody> <tr><td>687,-</td><td>1.329,-</td><td>1.562,-</td><td>1.669,-</td><td>1.998,-</td></tr> <tr><th>F</th><th>G</th><th>H</th><th>I</th><th>L</th></tr> <tr><td>1.814,-</td><td>1.562,-</td><td>1.974,-</td><td>2.396,-</td><td>2.876,-</td></tr> </tbody> </table>	A	B	C	D	E	687,-	1.329,-	1.562,-	1.669,-	1.998,-	F	G	H	I	L	1.814,-	1.562,-	1.974,-	2.396,-	2.876,-
A	B	C	D	E																			
687,-	1.329,-	1.562,-	1.669,-	1.998,-																			
F	G	H	I	L																			
1.814,-	1.562,-	1.974,-	2.396,-	2.876,-																			
Empfohlen Recommended																							
	649.13.756 Wandarm 1/2" <ul style="list-style-type: none"> Ausladung 350 mm weitere, zur Serie passende Wandarme siehe Kapitel "Brausen" 	Wall bracket 1/2" <ul style="list-style-type: none"> projection 350 mm for further wall brackets matching this collection see chapter "showers" 	<table border="1"> <thead> <tr><th>A</th><th>B</th><th>C</th><th>D</th><th>E</th></tr> </thead> <tbody> <tr><td>135,-</td><td>299,-</td><td>332,-</td><td>366,-</td><td>499,-</td></tr> <tr><th>F</th><th>G</th><th>H</th><th>I</th><th>L</th></tr> <tr><td>435,-</td><td>299,-</td><td>344,-</td><td>566,-</td><td>636,-</td></tr> </tbody> </table>	A	B	C	D	E	135,-	299,-	332,-	366,-	499,-	F	G	H	I	L	435,-	299,-	344,-	566,-	636,-
A	B	C	D	E																			
135,-	299,-	332,-	366,-	499,-																			
F	G	H	I	L																			
435,-	299,-	344,-	566,-	636,-																			
	649.13.526 Seitenbrause 1/2" <ul style="list-style-type: none"> Rosette 125 x 125 mm, Wandmontage Brausekopf schwenkbar, 20° Anti-Kalk-System Ausführung Kunststoff 	Body spray side shower 1/2" <ul style="list-style-type: none"> escutcheon 125 x 125 mm, wall assembly swivel shower head, 20° anticalcareous system plastic 	<table border="1"> <thead> <tr><th>A</th><th>B</th><th>C</th><th>D</th><th>E</th></tr> </thead> <tbody> <tr><td>186,-</td><td>329,-</td><td>384,-</td><td>406,-</td><td>542,-</td></tr> <tr><th>F</th><th>G</th><th>H</th><th>I</th><th>L</th></tr> <tr><td>508,-</td><td>392,-</td><td>472,-</td><td>659,-</td><td>944,-</td></tr> </tbody> </table>	A	B	C	D	E	186,-	329,-	384,-	406,-	542,-	F	G	H	I	L	508,-	392,-	472,-	659,-	944,-
A	B	C	D	E																			
186,-	329,-	384,-	406,-	542,-																			
F	G	H	I	L																			
508,-	392,-	472,-	659,-	944,-																			
	649.13.381 Handbrause 1/2" <ul style="list-style-type: none"> Anti-Kalk-System 3 Strahlarten: Normal, Soft, Schwall Anschluß 1/2" Ausführung ABS weitere, zur Serie passende Handbrausen siehe Kapitel "Brausen" 	Hand shower 1/2" <ul style="list-style-type: none"> anticalcareous system with 3 jets: normal, soft, cascade connection 1/2" material ABS for further hand showers matching this collection see chapter "showers" 	<table border="1"> <thead> <tr><th>A</th><th>B</th><th>C</th><th>D</th><th>E</th></tr> </thead> <tbody> <tr><td>69,-</td><td>172,-</td><td>259,-</td><td>299,-</td><td>476,-</td></tr> <tr><th>F</th><th>G</th><th>H</th><th>I</th><th>L</th></tr> <tr><td>392,-</td><td>289,-</td><td>449,-</td><td>668,-</td><td>869,-</td></tr> </tbody> </table>	A	B	C	D	E	69,-	172,-	259,-	299,-	476,-	F	G	H	I	L	392,-	289,-	449,-	668,-	869,-
A	B	C	D	E																			
69,-	172,-	259,-	299,-	476,-																			
F	G	H	I	L																			
392,-	289,-	449,-	668,-	869,-																			

CHARLESTON SQUARE

Maßzeichnungen unter www.joerger.de - Menü SERVICE.
 Technical specifications under www.joerger.de - menu SERVICE.

A chrom chrome	[.000]	E platin matt platinum matt	[.066]
B silbernickel polished nickel	[.035]	F nerz matt milk matt	[.096]
C nerz milk	[.095]	G schwarz-matt black matt	[.092]
C nickel matt satin nickel	[.036]	G weiß-matt white matt	[.052]
D edelmessing sunshine	[.040]	H bronze bronze	[.011]
D platin platinum	[.065]	I gold gold	[.020]
E edelmess.matt sunshine matt	[.041]	L roségold rosegold	[.022]
E gold matt gold matt	[.021]	L roségold matt rosegold matt	[.023]

Accessoires für Handtücher | Accessories for towels

	634.00.002 Handtuchhalter ■ Rohr starr, ca. 410 mm	Towel bar ■ rigid bar, approx. 410 mm	A	B	C	D	E
			197,-	273,-	338,-	382,-	448,-
			F	G	H	I	L
			437,-	338,-	418,-	541,-	812,-

	634.00.047 Handtuchring ■ ø ca. 235 mm ■ offene Ausführung	Towel ring ■ ø approx. 235 mm ■ open version	A	B	C	D	E
			270,-	399,-	458,-	519,-	599,-
			F	G	H	I	L
			548,-	458,-	568,-	729,-	909,-

	634.00.022 Handtuchhaken	Robe hanger	A	B	C	D	E
			92,-	142,-	154,-	174,-	205,-
			F	G	H	I	L
			197,-	173,-	192,-	249,-	419,-

	634.00.040 Badetuchhalter ■ ca. 800 mm	Bath towel bar ■ approx. 800 mm	A	B	C	D	E
			318,-	478,-	542,-	612,-	712,-
			F	G	H	I	L
			649,-	542,-	665,-	862,-	1.619,-

	634.00.031 Wannengriff ■ ca. 300 mm	Tub handle ■ approx. 300 mm	A	B	C	D	E
			294,-	378,-	406,-	444,-	488,-
			F	G	H	I	L
			454,-	392,-	464,-	581,-	1.056,-

	634.00.104 Gästehandtuchkorb, eckig ■ mit Ablage ■ Korbgröße 260 x 150 x 190 mm	Guest towel basket, angular ■ with shelf ■ basket size 260 x 150 x 190 mm	A	B	C	D	E
			230,-	314,-	356,-	389,-	528,-
			F	G	H	I	L
			466,-	492,-	675,-	849,-	1.499,-

Accessoires für Waschplatz | Accessories for washstands

	634.00.007 Seifenhalter, komplett ■ Seifenschale aus Kristallglas	Soap dish holder, complete ■ crystal glass dish	A	B	C	D	E
			184,-	287,-	314,-	354,-	414,-
			F	G	H	I	L
			396,-	318,-	386,-	499,-	572,-

713.00.307 Seifenschale, lose	Glass dish, separate	A				
		74,-				

CHARLESTON SQUARE

Maßzeichnungen unter www.joerger.de - Menü SERVICE.
 Technical specifications under www.joerger.de - menu SERVICE.

A chrom chrome	[.000]	E platin matt platinum matt	[.066]
B silbernickel polished nickel	[.035]	F nerz matt milk matt	[.096]
C nerz milk	[.095]	G schwarz-matt black matt	[.092]
C nickel matt satin nickel	[.036]	G weiß-matt white matt	[.052]
D edelmessing sunshine	[.040]	H bronze bronze	[.011]
D platin platinum	[.065]	I gold gold	[.020]
E edelmess.matt sunshine matt	[.041]	L roségold rosegold	[.022]
E gold matt gold matt	[.021]	L roségold matt rosegold matt	[.023]



634.00.006 Lotionspender, komplett

Soap dispenser, complete

A	B	C	D	E
268,-	356,-	392,-	454,-	532,-
F	G	H	I	L
505,-	399,-	498,-	636,-	869,-

713.00.306 Lotionspenderglas, lose
 ■ seidenmatt, ohne Pumpe

Soap dispenser glass, separate
 ■ frosted glass, without pump

A	B	C	D	E
78,-				



634.00.105 Schwammkorb
 ■ rechteckig, 260 x 130 mm

Sponge basket
 ■ rectangular, 260 x 130 mm

A	B	C	D	E
199,-	238,-	279,-	332,-	462,-
F	G	H	I	L
396,-	348,-	459,-	589,-	859,-



634.00.106 Eckschwammkorb
 ■ 195 x 195 mm

Corner sponge basket
 ■ 195 x 195 mm

A	B	C	D	E
195,-	234,-	275,-	328,-	458,-
F	G	H	I	L
390,-	344,-	455,-	585,-	855,-



634.00.036 Glashalter, komplett
 ■ Glas aus Kristallglas

Tumbler holder, complete
 ■ crystal glass tumbler

A	B	C	D	E
188,-	292,-	318,-	358,-	418,-
F	G	H	I	L
399,-	322,-	392,-	506,-	576,-

713.00.336 Mundglas, lose

Glass tumbler, separate

A	B	C	D	E
78,-				

Accessoires für WC-Bereich | Accessories for w.c. area



634.00.014 Papierhalter
 ■ mit Deckel

Toilet paper roll holder
 ■ with lid

A	B	C	D	E
198,-	249,-	299,-	338,-	412,-
F	G	H	I	L
366,-	299,-	369,-	462,-	989,-



634.00.015 Reserve-Papierhalter

Spare toilet paper roll holder

A	B	C	D	E
182,-	238,-	274,-	309,-	362,-
F	G	H	I	L
348,-	272,-	354,-	418,-	619,-

CHARLESTON SQUARE

Maßzeichnungen unter www.joerger.de - Menü SERVICE.
 Technical specifications under www.joerger.de - menu SERVICE.

A chrom chrome	[.000]	E platin matt platinum matt	[.066]
B silbernickel polished nickel	[.035]	F nerz matt mink matt	[.096]
C nerz mink	[.095]	G schwarz-matt black matt	[.092]
C nickel matt satin nickel	[.036]	G weiß-matt white matt	[.052]
D edelmessing sunshine	[.040]	H bronze bronze	[.011]
D platin platinum	[.065]	I gold gold	[.020]
E edelmess.matt sunshine matt	[.041]	L roségold rosegold	[.022]
E gold matt gold matt	[.021]	L roségold matt rosegold matt	[.023]



634.00.000 Klosettbürstengarnitur, komplett ■ Glas aus Kristallglas, seidenmatt	Toilet brush holder set, complete ■ crystal-glass, frosted	A	B	C	D	E
		282,-	358,-	468,-	527,-	612,-
799.00.300 Bürstenglas, seidenmatt, lose	Brush glass, frosted, separate	F	G	H	I	L
		556,-	442,-	579,-	762,-	918,-
663.00.053 Bürstenstange, komplett, lose	Brush rod with brush, separate	A	B	C	D	E
		108,-	140,-	174,-	188,-	238,-
799.00.237 Bürstenkopf, lose	Brush, separate	F	G	H	I	L
		218,-	168,-	232,-	259,-	292,-
		A	B	C	D	E
		22,-				

Spiegel | Mirror



649.00.418 Kosmetikspiegel, beleuchtet ■ schwenk- und ausziehbar ■ 3-fache Vergrößerung ■ Direktanschluss ■ Spiegeldurchmesser 185 mm ■ Rahmendurchmesser 250 mm ■ Kalt-, Warm- und Taglicht durch Piezzo-Schalter umschaltbar	Cosmetic mirror, incl. lighting ■ swivelling and extendable ■ magnification 3:1 ■ direct connection ■ mirror diameter 185 mm ■ frame diameter 250 mm ■ cold, warm and day light switchable by Piezzo switch	A	B	C	D	E
		556,-	988,-	1.214,-	1.418,-	1.828,-
		F	G	H	I	L
		1.684,-	1.214,-	1.549,-	2.138,-	2.998,-

EMPIRE ROYAL



Oberflächen | colours

Folgende Oberflächen sind bei dieser Serie möglich |
The following colours are possible with this collection

chrom		chrome	[.000]	PG A
silbernickel		polished nickel	[.035]	PG B
nerz		mink	[.095]	PG C
nickel matt		satin nickel	[.036]	PG C
edelmessing		sunshine	[.040]	PG D
platin		platinum	[.065]	PG D
edelmessing matt		sunshine matt	[.041]	PG E
gold matt		gold matt	[.021]	PG E
platin matt		platinum matt	[.066]	PG E
nerz matt		mink matt	[.096]	PG F
schwarz matt		black matt	[.092]	PG G
weiß matt		white matt	[.052]	PG G
bronze		bronze	[.011]	PG H
gold		gold	[.020]	PG I
roségold		rosegold	[.022]	PG L
roségold matt		rosegold matt	[.023]	PG L

Andere Oberflächen auf Anfrage |
Different colours on request

Auf Anfrage können wir Produkte von Drittanbietern auch gerne passend zu unseren Oberflächen veredeln (vorbehaltlich der Eignungsprüfung) | Third-party products may be plated matching to our colours on request (subject to valuation of suitability)

Waschtisch | Washbasin

ab Seite | from page 068

Bidet | Bidet

ab Seite | from page 071

Wanne | Bath tub

ab Seite | from page 072

Dusche | Shower

ab Seite | from page 073

Accessoires | Accessories

ab Seite | from page 079

EMPIRE ROYAL

Maßzeichnungen unter www.joerger.de - Menü SERVICE.
 Technical specifications under www.joerger.de - menu SERVICE.

A chrom chrome	[.000]	E platin matt platinum matt	[.066]
B silbernickel polished nickel	[.035]	F nerz matt mink matt	[.096]
C nerz mink	[.095]	G schwarz-matt black matt	[.092]
C nickel matt satin nickel	[.036]	G weiß-matt white matt	[.052]
D edelmessing sunshine	[.040]	H bronze bronze	[.011]
D platin platinum	[.065]	I gold gold	[.020]
E edelmess.matt sunshine matt	[.041]	L roségold rosegold	[.022]
E gold matt gold matt	[.021]	L roségold matt rosegold matt	[.023]

Waschtisch Batterien mit Rechteck-Luftsprudler | Washbasin mixer with rectangular aerator



Die nachfolgenden Waschtisch-Armaturen sind mit einem rechteckigen Luftsprudler ausgestattet, welcher das Wasser sanft ins Becken fließen lässt und gleichzeitig wassersparend ausgeführt ist.

The following washbasin mixers are equipped with a rectangular aerator, which allows the water to flow gently into the basin and at the same time is designed to save water.



626.30.305 Waschtisch 3-Loch Batterie 1/2"
 ■ Exzenter-Ablaufgarnitur mit quadratischem Stopfen
 ■ Ausladung 155 mm; Höhe 260 mm
 ■ 2 Seitenrandventile mit keramischen Oberteilen 1/2"
 ■ empfohlen:
 2x 649.15.530 - Kupferrohr 300 mm



Washbasin 3-hole mixer 1/2"
 ■ pop-up waste square design
 ■ spout projection 155 mm; height 260 mm
 ■ 2 side valves with ceramic internal upper parts 1/2"
 ■ recommended:
 2x 649.15.530 - copper tube 300 mm

A	B	C	D	E
778,-	1.128,-	1.268,-	1.468,-	1.728,-
F	G	H	I	L
1.574,-	1.368,-	1.618,-	1.958,-	2.678,-

Variante | Alternative

626.30.805 Waschtisch 3-Loch Batterie 1/2"
 ■ Exzenter-Ablaufgarnitur mit rundem Stopfen



Washbasin 3-hole mixer 1/2"
 ■ pop-up waste round design

A	B	C	D	E
689,-	1.056,-	1.194,-	1.394,-	1.654,-
F	G	H	I	L
1.499,-	1.294,-	1.596,-	1.882,-	2.604,-



626.10.333 Waschtisch 1-Hand Batterie
 ■ Exzenter-Ablaufgarnitur mit quadratischem Stopfen
 ■ Ausladung 152 mm; Höhe 285 mm
 ■ Auslauf schwenkbar
 ■ 2 Druckschläuche M10x1 x 450 mm



Single lever washbasin mixer
 ■ pop-up waste square design
 ■ spout projection 152 mm; height 285 mm
 ■ swivelling spout
 ■ cartridge with ceramic discs
 ■ 2 pressure hoses M10x1 x 450 mm

A	B	C	D	E
719,-	926,-	1.052,-	1.198,-	1.399,-
F	G	H	I	L
1.310,-	1.246,-	1.484,-	1.692,-	2.658,-

Variante | Alternative

626.10.833 Waschtisch 1-Hand Batterie
 ■ Exzenter-Ablaufgarnitur mit rundem Stopfen



Single lever washbasin mixer
 ■ pop-up waste round design

A	B	C	D	E
636,-	852,-	978,-	1.124,-	1.328,-
F	G	H	I	L
1.232,-	1.172,-	1.410,-	1.618,-	2.494,-

626.10.334 Waschtisch 1-Hand Batterie
 ■ ohne Exzenter-Ablaufgarnitur



Single lever washbasin mixer
 ■ without pop-up waste

A	B	C	D	E
576,-	718,-	868,-	996,-	1.149,-
F	G	H	I	L
1.074,-	1.065,-	1.283,-	1.473,-	2.283,-

EMPIRE ROYAL

Maßzeichnungen unter www.joerger.de - Menü SERVICE.
 Technical specifications under www.joerger.de - menu SERVICE.

A chrom chrome	[.000]	E platin matt platinum matt	[.066]
B silbernickel polished nickel	[.035]	F nerz matt mink matt	[.096]
C nerz mink	[.095]	G schwarz-matt black matt	[.092]
C nickel matt satin nickel	[.036]	G weiß-matt white matt	[.052]
D edelmessing sunshine	[.040]	H bronze bronze	[.011]
D platin platinum	[.065]	I gold gold	[.020]
E edelmess.matt sunshine matt	[.041]	L roségold rosegold	[.022]
E gold matt gold matt	[.021]	L roségold matt rosegold matt	[.023]

Waschtisch Batterien mit rundem Luftsprudler | Washbasin mixer with round aerator



Die nachfolgenden Waschtisch-Armaturen sind mit einem harmonisch runden Luftsprudler ausgestattet, welcher das Wasser sanft und elegant ins Becken fließen lässt und gleichzeitig wassersparend ausgeführt ist.

The following washbasin mixers are equipped with a harmonious, round aerator, which allows the water to flow gently and elegantly into the basin and at the same time is designed to save water.



627.30.305 Waschtisch 3-Loch Batterie ½“
 ■ Exzenter-Ablaufgarnitur mit quadratischem Stopfen
 ■ Ausladung 155 mm; Höhe 260 mm
 ■ 2 Seitenrandventile mit keramischen Oberteilen ½“
 ■ empfohlen:
 2x 649.15.530 - Kupferrohr 300 mm



Washbasin 3-hole mixer ½“
 ■ pop-up waste square design
 ■ spout projection 155 mm; height 260 mm
 ■ 2 side valves with ceramic internal upper parts ½“
 ■ recommended:
 2x 649.15.530 - copper tube 300 mm

A	B	C	D	E
1.118,-	1.288,-	1.399,-	1.585,-	1.857,-
F	G	H	I	L
1.692,-	1.485,-	1.838,-	2.075,-	2.896,-

Variante | Alternative

627.30.805 Waschtisch 3-Loch Batterie ½“
 ■ Exzenter-Ablaufgarnitur mit rundem Stopfen



Washbasin 3-hole mixer ½“
 ■ pop-up waste round design

A	B	C	D	E
952,-	1.174,-	1.278,-	1.445,-	1.726,-
F	G	H	I	L
1.618,-	1.452,-	1.798,-	1.999,-	2.822,-



627.10.333 Waschtisch 1-Hand Batterie
 ■ Exzenter-Ablaufgarnitur mit quadratischem Stopfen
 ■ Ausladung 152 mm; Höhe 285 mm
 ■ Auslauf schwenkbar
 ■ 2 Druckschläuche M10x1 x 450 mm



Single lever washbasin mixer
 ■ pop-up waste square design
 ■ spout projection 152 mm; height 285 mm
 ■ swivelling spout
 ■ cartridge with ceramic discs
 ■ 2 pressure hoses M10x1 x 450 mm

A	B	C	D	E
852,-	1.056,-	1.142,-	1.288,-	1.492,-
F	G	H	I	L
1.396,-	1.336,-	1.574,-	1.782,-	2.758,-

Variante | Alternative

627.10.833 Waschtisch 1-Hand Batterie
 ■ Exzenter-Ablaufgarnitur mit rundem Stopfen



Single lever washbasin mixer
 ■ pop-up waste round design

A	B	C	D	E
768,-	982,-	1.068,-	1.214,-	1.428,-
F	G	H	I	L
1.322,-	1.262,-	1.499,-	1.708,-	2.684,-

627.10.334 Waschtisch 1-Hand Batterie
 ■ ohne Exzenter-Ablaufgarnitur



Single lever washbasin mixer
 ■ without pop-up waste

A	B	C	D	E
708,-	868,-	958,-	1.086,-	1.239,-
F	G	H	I	L
1.164,-	1.155,-	1.373,-	1.563,-	2.373,-

EMPIRE ROYAL

Maßzeichnungen unter www.joerger.de - Menü SERVICE.
 Technical specifications under www.joerger.de - menu SERVICE.

A chrom chrome	[.000]	E platin matt platinum matt	[.066]
B silbernickel polished nickel	[.035]	F nerz matt mink matt	[.096]
C nerz mink	[.095]	G schwarz-matt black matt	[.092]
C nickel matt satin nickel	[.036]	G weiß-matt white matt	[.052]
D edelmessing sunshine	[.040]	H bronze bronze	[.011]
D platin platinum	[.065]	I gold gold	[.020]
E edelmess.matt sunshine matt	[.041]	L roségold rosegold	[.022]
E gold matt gold matt	[.021]	L roségold matt rosegold matt	[.023]

Waschtisch Batterien mit rundem Luftsprudler | Washbasin mixer with round aerator



Die nachfolgenden Waschtisch-Armaturen sind mit einem harmonisch runden Luftsprudler ausgestattet, welcher das Wasser sanft und elegant ins Becken fließen lässt und gleichzeitig wassersparend ausgeführt ist.

The following washbasin mixers are equipped with a harmonious, round aerator, which allows the water to flow gently and elegantly into the basin and at the same time is designed to save water.



- 627.10.353** Waschtisch 1-Hand Batterie, XXL
- Exzenter-Ablaufgarnitur mit quadratischem Stopfen
 - Ausladung 230 mm; Höhe 325 mm
 - Auslauf schwenkbar
 - 2 Druckschläuche M10x1 x 450 mm



- Single lever washbasin mixer, XXL
- pop-up waste square design
 - spout projection 230 mm; height 325 mm
 - swivelling spout
 - cartridge with ceramic discs
 - 2 pressure hoses M10x1 x 450 mm

A	B	C	D	E
910,-	1.133,-	1.230,-	1.464,-	1.794,-
F	G	H	I	L
1.687,-	1.415,-	1.774,-	2.058,-	3.162,-

Variante | Alternative

- 627.10.853** Waschtisch 1-Hand Batterie, XXL
- Exzenter-Ablaufgarnitur mit rundem Stopfen



- Single lever washbasin mixer, XXL
- pop-up waste round design

A	B	C	D	E
824,-	1.055,-	1.163,-	1.421,-	1.741,-
F	G	H	I	L
1.699,-	1.264,-	1.534,-	1.997,-	2.690,-

- 627.10.354** Waschtisch 1-Hand Batterie, XXL
- ohne Exzenter-Ablaufgarnitur



- Single lever washbasin mixer, XXL
- without pop-up waste

A	B	C	D	E
765,-	925,-	1.002,-	1.354,-	1.659,-
F	G	H	I	L
1.575,-	1.128,-	1.446,-	1.902,-	2.589,-



- 627.10.722** Handwaschbecken 1-Hand Batterie
- Exzenter-Ablaufgarnitur mit rundem Stopfen
 - Ausladung 75 mm; Höhe 240 mm
 - Auslauf schwenkbar
 - 2 Druckschläuche M10x1 x 450 mm



- Single lever mini washbasin mixer
- pop-up waste round design
 - spout projection 75 mm; height 240 mm
 - swivelling spout
 - cartridge with ceramic discs
 - 2 pressure hoses M10x1 x 450 mm

A	B	C	D	E
768,-	966,-	1.054,-	1.232,-	1.496,-
F	G	H	I	L
1.381,-	1.221,-	1.496,-	1.710,-	2.659,-



- 627.30.361** Wand-Waschtisch 3-Loch Batterie 1/2", Fertigmontageset
- Wand-Auslauf, Ausladung 200 - 212 mm
 - Griff, Hülse, Schubrosette
 - Oberteile 1/2", keramische Scheiben

- Wall washbasin 3-hole mixer 1/2", assembly set
- wall spout, projection 200 - 212 mm
 - design handle, socket with adjustable escutcheon
 - cartridges 1/2", with ceramic discs

A	B	C	D	E
846,-	1.020,-	1.200,-	1.351,-	1.590,-
F	G	H	I	L
1.492,-	1.241,-	1.518,-	1.929,-	2.812,-

Variante | Alternative

- 627.30.366** Wand-Waschtisch 3-Loch XXL Batterie 1/2", Fertigmontageset
- Wand-Auslauf, Ausladung 260 - 272 mm

- Wall washbasin 3-hole XXL mixer 1/2", assembly set
- wall spout, projection 260 - 272 mm

A	B	C	D	E
862,-	1.045,-	1.214,-	1.365,-	1.609,-
F	G	H	I	L
1.530,-	1.254,-	1.529,-	1.949,-	2.841,-

Benötigt | Required

- 649.30.380** Wand-Waschtisch 3-Loch Batterie 1/2", Einbaukörper
- 2 Anschlüsse, Stichmaß 204 mm
 - zu Fertigmontageset 627.30.360 und 627.30.365



- Wall washbasin 3-hole mixer 1/2", concealed body
- 2 connections, center distance 204 mm
 - for assembly set 627.30.360 and 627.30.365

A	B	C	D	E
296,-				

EMPIRE ROYAL

Maßzeichnungen unter www.joerger.de - Menü SERVICE.
 Technical specifications under www.joerger.de - menu SERVICE.

A chrom chrome	[.000]	E platin matt platinum matt	[.066]
B silbernickel polished nickel	[.035]	F nerz matt mink matt	[.096]
C nerz mink	[.095]	G schwarz-matt black matt	[.092]
C nickel matt satin nickel	[.036]	G weiß-matt white matt	[.052]
D edelmessing sunshine	[.040]	H bronze bronze	[.011]
D platin platinum	[.065]	I gold gold	[.020]
E edelmess.matt sunshine matt	[.041]	L roségold rosegold	[.022]
E gold matt gold matt	[.021]	L roségold matt rosegold matt	[.023]

	627.20.360 Wand-Waschtisch 1-Hand Batterie 1/2", Fertigmontageset <ul style="list-style-type: none"> Wand-Auslauf Ausladung 184 - 198 mm Kartusche mit keramischen Scheiben Wandrosette 	Single lever wall washbasin mixer 1/2", assembly set <ul style="list-style-type: none"> wall spout projection 184 - 198 mm cartridge with ceramic discs escutcheon 	A	B	C	D	E
			688,-	846,-	1.006,-	1.132,-	1.331,-
			F	G	H	I	L
			1.257,-	1.120,-	1.366,-	1.618,-	2.578,-

Benötigt | Required

	649.20.362 Wand-Waschtisch 1-Hand Batterie 1/2", Einbaukörper <ul style="list-style-type: none"> zu Fertigmontageset 627.20.360 Kartusche mit ker. Scheiben 	Single lever wall washbasin mixer 1/2", concealed body <ul style="list-style-type: none"> for assembly set 627.20.360 cartridge with ceramic discs 	A				
			258,-				

Bidet Batterien | Bidet mixer

	627.10.611 Bidet 1-Hand Batterie <ul style="list-style-type: none"> Exzenter-Ablaufgarnitur mit rundem Stopfen Ausladung 140 mm; Höhe 210 mm Kartusche mit keramischen Scheiben 2 Druckschläuche M10x1 x 450 mm 	Single lever bidet mixer <ul style="list-style-type: none"> pop-up waste round design spout projection 140 mm; height 210 mm cartridge with ceramic discs 2 pressure hoses M10x1 x 450 mm 	A	B	C	D	E
			798,-	1.057,-	1.205,-	1.357,-	1.662,-
			F	G	H	I	L
			1.575,-	1.244,-	1.516,-	1.906,-	2.678,-

Zubehör für Waschtisch- und Bidet-Batterien | Supplies for washbasin and bidet mixer

	649.10.071 Rohrverlängerung, Höhe 150 mm <ul style="list-style-type: none"> für alle 1-Hand Batterien 	Body extension, height 150 mm <ul style="list-style-type: none"> for all single lever mixer 	A	B	C	D	E
			298,-	342,-	392,-	440,-	516,-
			F	G	H	I	L
			489,-	487,-	620,-	572,-	1.096,-

	626.12.100 Eckventil 1/2" <ul style="list-style-type: none"> Ausladung 100 mm Fettkammer-Innenoberteil 1/2" Quetschverschraubung Schubrosette 	Angle valve 1/2" <ul style="list-style-type: none"> projection 100 mm cartridge 1/2" compression joint escutcheon 	A	B	C	D	E
			145,-	196,-	248,-	296,-	448,-
			F	G	H	I	L
			392,-	265,-	424,-	529,-	698,-

	649.15.530 Kupferrohr, 300 mm <ul style="list-style-type: none"> mit Bördel, für Quetschverschraubung 	Copper tube, 300 mm <ul style="list-style-type: none"> with flange, for compression joint 	A	B	C	D	E
			15,-	38,-	55,-	62,-	74,-
			F	G	H	I	L
			69,-	75,-	94,-	112,-	169,-

Variante | Alternative

	649.15.550 Kupferrohr, 500 mm <ul style="list-style-type: none"> mit Bördel, für Quetschverschraubung 	Copper tube, 500 mm <ul style="list-style-type: none"> with flange, for compression joint 	A	B	C	D	E
			20,-	58,-	77,-	87,-	102,-
			F	G	H	I	L
			97,-	77,-	96,-	134,-	219,-

EMPIRE ROYAL

Maßzeichnungen unter www.joerger.de - Menü SERVICE.
 Technical specifications under www.joerger.de - menu SERVICE.

A chrom chrome	[.000]	E platin matt platinum matt	[.066]
B silbernickel polished nickel	[.035]	F nerz matt mink matt	[.096]
C nerz mink	[.095]	G schwarz-matt black matt	[.092]
C nickel matt satin nickel	[.036]	G weiß-matt white matt	[.052]
D edelmessing sunshine	[.040]	H bronze bronze	[.011]
D platin platinum	[.065]	I gold gold	[.020]
E edelmess.matt sunshine matt	[.041]	L roségold rosegold	[.022]
E gold matt gold matt	[.021]	L roségold matt rosegold matt	[.023]

	649.15.380 Waschtisch-Tassensiphon 1 ¼" ■ massive, eckige Ausführung ■ Rosette ■ Abgangsrohr ø 32 mm	Washbasin cupped siphon trap 1 ¼" ■ heavy brass, square design ■ escutcheon ■ outlet tube ø 32 mm	A	B	C	D	E
			289,-	349,-	423,-	440,-	569,-
			F	G	H	I	L
			492,-	497,-	642,-	739,-	925,-

	649.15.290 Zwangsablaufventil ■ Schaftlänge 70 mm ■ für Waschbecken ohne Überlauf	Restraint drain/waste ■ length of shaft 70 mm ■ for washbasins without overflow	A	B	C	D	E
			93,-	116,-	172,-	192,-	255,-
			F	G	H	I	L
			224,-	247,-	414,-	464,-	612,-

Badewanne, Stand-Batterien | Bath tub mixer sets, deck mount

	626.40.105 4-Loch Wannenfüll- und Brausebatterie ½", für Standmontage ■ Ausladung 215 mm; Höhe 285 mm ■ 2 Seitenrandventile mit keramischen Oberteilen ½", ■ Metall-Brauseschlauch 2000 mm ■ Metall-Handbrause mit Anti-Kalk-System und Rückflussverhinderer	Tub/shower mixer set ½", deck mount ■ spout projection 215 mm; height 285 mm ■ 2 side valves, ½" cer. internal upper parts ; metal shower hose 2000 mm ■ metal hand shower with anticalc. system and backflow preventer	A	B	C	D	E
			1.494,-	1.769,-	2.019,-	2.229,-	2.539,-
			F	G	H	I	L
			2.455,-	1.970,-	2.584,-	3.072,-	3.579,-

Empfohlen | Recommended

	649.40.160 Montageplatte, komplett ■ für 4-Loch Armaturen ■ Druckschläuche ½" x ½" x 600 mm ■ empfohlen: Schlauchkastensystem siehe Kapitel "Serienübergreifendes"	Assembly plate, complete ■ for deck mounted tub/shower mixer ■ pressure hoses ½"x ½" x 600 mm ■ recommended: system with hose box see chapter "universal products"	A				
			308,-				

	626.40.155 4-Loch Wannenrandkombination ½" ■ für Ab- und Überlaufgarnitur mit Wanneneinlauf, ohne Rohrunterbrecher ■ Seitenrandventile, 2-Wege Umstellung ■ Metall-Brauseschlauch 2000 mm ■ Metall-Handbrause mit Anti-Kalk-System und Rückflussverhinderer	tub/shower combination ½" ■ for waste and overflow set with bath tub filler spout, without pipe interrupter ■ side valves, 2-position diverter ■ metal shower hose 2000 mm ■ metal hand shower with anticalc. system and backflow preventer	A	B	C	D	E
			1.148,-	1.432,-	1.699,-	1.899,-	2.162,-
			F	G	H	I	L
			2.109,-	1.709,-	2.379,-	2.746,-	3.195,-

Empfohlen | Recommended

	649.40.160 Montageplatte, komplett ■ für 4-Loch Armaturen ■ Druckschläuche ½" x ½" x 600 mm ■ empfohlen: Schlauchkastensystem siehe Kapitel "Serienübergreifendes"	Assembly plate, complete ■ for deck mounted tub/shower mixer ■ pressure hoses ½"x ½" x 600 mm ■ recommended: system with hose box see chapter "universal products"	A				
			308,-				

EMPIRE ROYAL

Maßzeichnungen unter www.joerger.de - Menü SERVICE.
 Technical specifications under www.joerger.de - menu SERVICE.

A chrom chrome	[.000]	E platin matt platinum matt	[.066]
B silbernickel polished nickel	[.035]	F nerz matt milk matt	[.096]
C nerz milk	[.095]	G schwarz-matt black matt	[.092]
C nickel matt satin nickel	[.036]	G weiß-matt white matt	[.052]
D edelmessing sunshine	[.040]	H bronze bronze	[.011]
D platin platinum	[.065]	I gold gold	[.020]
E edelmess.matt sunshine matt	[.041]	L roségold rosegold	[.022]
E gold matt gold matt	[.021]	L roségold matt rosegold matt	[.023]



- 626.10.820 Wannen 1-Hand Batterie**
- für freistehende Montage
 - Ausladung 215 mm
 - Umstellung Wanne/Brause
 - Metall- Handbrause mit Anti-Kalk-System und Rückflußverhinderer
 - Metall- Brauseschlauch 1500 mm
 - Standrohr mit Befestigungsflansch
 - Kartusche mit keramischen Scheiben
 - Höhe gesamt 970 - 1055 mm
 - Höhe bis Auslauf 885 - 965 mm

- Tub/shower mixer set**
- free standing assembly
 - spout projection 215 mm
 - diverter spout/hand shower
 - metal hand shower with anticalc. system and backflow preventer
 - metal shower hose 1500 mm
 - Pillar tube with flange
 - ceramic internal upper part
 - height 970 - 1055 mm
 - outlet height 885 - 965 mm

A	B	C	D	E
2.467,-	2.845,-	3.192,-	3.589,-	4.419,-
F	G	H	I	L
3.964,-	3.012,-	4.192,-	5.069,-	5.659,-

Benötigt | Required

- 649.10.970 Bausatz-Vormontage**
- Bodenplatte mit Befestigungsset
 - zu Fertigmontageset 626.10.820



- Assembly set for pre-installation**
- joint plate with fixing set
 - for assembly set 626.10.820

A	B	C	D	E
549,-				

Badewanne, Aufputz-Batterien | Bath tub mixer sets, exposed



- 626.20.500 1-Hand Aufputz-Wannenfüll- und Brausebatterie 1/2", mit Garnitur**
- Ausladung 176 mm
 - Metall-Handbrause mit Anti-Kalk-System und Rückflussverhinderer
 - Metall-Brauseschlauch 1500 mm, beidseitig mit drehbarem Konus

- Single lever exposed tub/shower mixer 1/2", incl. shower set**
- spout projection 176 mm
 - metal hand shower with anticalc. system and backflow preventer
 - metal shower hose 1500 mm, both sides with turning cone

A	B	C	D	E
1.389,-	1.714,-	1.868,-	1.998,-	2.342,-
F	G	H	I	L
2.242,-	1.768,-	2.238,-	2.677,-	3.548,-

Variante | Alternative



- 626.20.510 1-Hand Wannenfüll- und Brausebatterie 1/2" für Aufputzmontage, ohne Garnitur**

- Single lever exposed tub/shower mixer 1/2", without shower set**

A	B	C	D	E
1.039,-	1.294,-	1.398,-	1.585,-	1.858,-
F	G	H	I	L
1.769,-	1.388,-	1.718,-	2.123,-	2.899,-

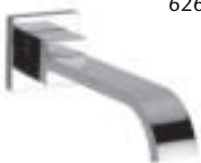

- 626.11.100 Wand-Wanneneinlauf 3/4"**
- Ausladung 200 - 212 mm
 - Steckanschluß-Montage

- Tub wall spout 3/4"**
- spout projection 200 - 212 mm
 - special concealed wall attachment

A	B	C	D	E
446,-	546,-	596,-	686,-	758,-
F	G	H	I	L
728,-	798,-	776,-	888,-	1.069,-

Dusche, Aufputz-Batterien | Shower mixer sets, exposed



- 626.20.600 1-Hand Brausebatterie 1/2" für Aufputzmontage**
- Kartusche mit keramischen Scheiben
 - Brauseabgang 1/2"
 - verdeckte S-Anschlüsse 1/2" x 3/4"

- Single lever exposed shower mixer 1/2"**
- cartridge with ceramic discs
 - discharge 1/2"
 - concealed S-connections 1/2" x 3/4"

A	B	C	D	E
939,-	1.194,-	1.312,-	1.384,-	1.769,-
F	G	H	I	L
1.602,-	1.264,-	1.498,-	1.947,-	2.526,-

EMPIRE ROYAL

Maßzeichnungen unter www.joerger.de - Menü SERVICE.
 Technical specifications under www.joerger.de - menu SERVICE.

A chrom chrome	[.000]	E platin matt platinum matt	[.066]
B silbernickel polished nickel	[.035]	F nerz matt mink matt	[.096]
C nerz mink	[.095]	G schwarz-matt black matt	[.092]
C nickel matt satin nickel	[.036]	G weiß-matt white matt	[.052]
D edelmessing sunshine	[.040]	H bronze bronze	[.011]
D platin platinum	[.065]	I gold gold	[.020]
E edelmess.matt sunshine matt	[.041]	L roségold rosegold	[.022]
E gold matt gold matt	[.021]	L roségold matt rosegold matt	[.023]

Unterputz-Hebelmischer 1/2" | Concealed single lever mixer 1/2"



626.20.125	1-Hand Wannenfüll- und Brausebatterie 1/2" für UP-Montage, Fertigmontageset	<ul style="list-style-type: none"> manuelle, keramische Umstellung für druckunabhängige Funktion mit Sicherheitseinrichtung Durchflussrate 21 l/min bei 3 bar 	Concealed single lever wall tub and shower mixer 1/2", assembly set	A	B	C	D	E
				858,-	1.078,-	1.249,-	1.295,-	1.574,-
				F	G	H	I	L
				1.469,-	1.142,-	1.416,-	1.699,-	1.948,-

Variante | Alternative



626.20.135	1-Hand Wannenfüll- und Brausebatterie 1/2" für UP-Montage, Fertigmontageset	<ul style="list-style-type: none"> manuelle, keramische Umstellung für druckunabhängige Funktion ohne Sicherheitseinrichtung Durchflussrate 21 l/min bei 3 bar 	Concealed single lever wall tub and shower mixer 1/2", assembly set	A	B	C	D	E
				838,-	1.058,-	1.229,-	1.275,-	1.554,-
				F	G	H	I	L
				1.449,-	1.122,-	1.396,-	1.679,-	1.928,-

Variante | Alternative



626.20.235	1-Hand Brausebatterie 1/2" für UP-Montage, Fertigmontageset	<ul style="list-style-type: none"> ohne Umstellung Funktionseinheit mit ker. Scheiben Durchflussrate 20,4 l/min bei 3 bar 	Concealed single lever shower mixer 1/2", assembly set	A	B	C	D	E
				669,-	817,-	983,-	1.084,-	1.356,-
				F	G	H	I	L
				1.239,-	872,-	1.169,-	1.438,-	1.799,-

Benötigt | Required



649.40.360	Unterputz-Einbaubox 1/2"	<ul style="list-style-type: none"> zu Fertigmontageset 626.20.125, 626.20.135 und 626.20.235 für Nass- und Trockenbau geeignet 	Concealed wall box 1/2"	A				
				168,-				

Unterputz-Thermostate 1/2" | Wall thermostats, concealed 1/2"



626.40.380	Unterputz-Thermostat 1/2" mit Mengenregulierung, Fertigmontageset	<ul style="list-style-type: none"> manuelle, keramische Umstellung Wanne/Brause, druckunabhängig mit Sicherheitseinrichtung Durchflussrate 20,4 l/min bei 3 bar 	Concealed wall thermostat 1/2" with flow control, assembly set	A	B	C	D	E
				1.179,-	1.342,-	1.436,-	1.545,-	1.829,-
				F	G	H	I	L
				1.718,-	1.466,-	1.638,-	1.949,-	2.508,-

Variante | Alternative



626.40.360	Unterputz-Thermostat 1/2" mit Mengenregulierung, Fertigmontageset	<ul style="list-style-type: none"> ohne Umstellung mit integrierter keramischer Mengenregulierung Durchflussrate 20,4 l/min bei 3 bar 	Concealed wall thermostat 1/2" with flow control, assembly set	A	B	C	D	E
				1.145,-	1.308,-	1.399,-	1.510,-	1.794,-
				F	G	H	I	L
				1.664,-	1.432,-	1.599,-	1.915,-	2.474,-

Variante | Alternative



626.40.460	Unterputz-Thermostat 1/2" ohne Mengenregulierung, Fertigmontageset	<ul style="list-style-type: none"> Funktionseinheit ohne Umstellung und ohne Absperrung Durchflussrate 25,8 l/min bei 3 bar 	Concealed wall thermostat 1/2" without flow control, assembly set	A	B	C	D	E
				929,-	1.078,-	1.184,-	1.316,-	1.577,-
				F	G	H	I	L
				1.469,-	1.280,-	1.428,-	1.691,-	2.244,-

Benötigt | Required



649.40.360	Unterputz-Einbaubox 1/2"	<ul style="list-style-type: none"> zu Fertigmontageset 626.40.360, 626.40.380 und 626.40.460 für Nass- und Trockenbau geeignet 	Concealed wall box 1/2"	A				
				168,-				

EMPIRE ROYAL

Maßzeichnungen unter www.joerger.de - Menü SERVICE.
 Technical specifications under www.joerger.de - menu SERVICE.

A chrom chrome	[.000]	E platin matt platinum matt	[.066]
B silbernickel polished nickel	[.035]	F nerz matt mink matt	[.096]
C nerz mink	[.095]	G schwarz-matt black matt	[.092]
C nickel matt satin nickel	[.036]	G weiß-matt white matt	[.052]
D edelmessing sunshine	[.040]	H bronze bronze	[.011]
D platin platinum	[.065]	I gold gold	[.020]
E edelmess.matt sunshine matt	[.041]	L roségold rosegold	[.022]
E gold matt gold matt	[.021]	L roségold matt rosegold matt	[.023]

Unterputz-Thermostat 3/4" mit hohem Durchfluß | Wall thermostat, concealed 3/4" with high flow



626.40.555 Unterputz-Thermostat 3/4" **ohne** Mengenregulierung, Fertigmontageset

- serienbezogener Temperiergriff
- Sicherheitssperre bei 38° C

Concealed wall thermostat 3/4" **without** flow control, assembly set

- design handle for temp. control
- locking device at 38°C

A	B	C	D	E
577,-	648,-	736,-	779,-	942,-
F	G	H	I	L
846,-	782,-	949,-	1.262,-	1.676,-

Benötigt | Required



649.40.555 Unterputz-Einbaukörper 3/4"

- zu Fertigmontageset 626.40.555
- Kartusche mit Schmutzfangsieben
- für Nass- und Trockenbau geeignet
- Durchflußrate 64,2 l/min bei 3 bar
- **ohne** Absperrung

Concealed thermostat body 3/4"

- for assembly set 626.40.555
- cartridge with filter screens
- for wetwall and drywall construction
- flow rate 64,2 l/min at 3 bar
- **without** shut-off

A	B	C	D	E
1.636,-				

Unterputz-Thermostat 3/4" | Wall thermostat, concealed 3/4"



626.40.520 Unterputz-Thermostat 3/4" **ohne** Mengenregulierung, Fertigmontageset

- serienbezogener Temperiergriff
- Sicherheitssperre bei 38° C

Concealed wall thermostat 3/4" **without** flow control, assembly set

- design handle for temp. control
- locking device at 38°C

A	B	C	D	E
577,-	648,-	736,-	779,-	942,-
F	G	H	I	L
846,-	782,-	949,-	1.262,-	1.676,-

Benötigt | Required



649.40.520 Unterputz-Einbaukörper 3/4"

- zu Fertigmontageset 626.40.520
- Kartusche mit Schmutzfangsieben
- für Nass- und Trockenbau geeignet
- Durchflußrate 41 l/min bei 3 bar
- **ohne** Absperrung

Concealed thermostat body 3/4"

- for assembly set 626.40.520
- cartridge with filter screens
- for wetwall and drywall construction
- flow rate 41 l/min at 3 bar
- **without** shut-off

A	B	C	D	E
498,-				

Unterputz-Umstellung und Ventile | Diverter and valves concealed



621.40.650 Unterputz 3-Wege Umstellung 1/2" Fertigmontageset

- Griff
- Hülse, Schubrosette

Concealed 3-position diverter 1/2" assembly set

- design handle
- socket with adjustable escutcheon

A	B	C	D	E
332,-	431,-	481,-	541,-	636,-
F	G	H	I	L
588,-	408,-	432,-	758,-	867,-

Benötigt | Required



649.40.600 Unterputz 3-Wege Umstellung 1/2" Einbaukörper

- zu Fertigmontageset 626.40.650

Concealed 3-position diverter 1/2" diverter body

- for assembly set 626.40.650

A	B	C	D	E
236,-				



621.50.234 Unterputz-Ventil Fertigmontageset

- Griff
- Hülse, Schubrosette

Concealed wall valve assembly set

- design handle
- socket with adjustable escutcheon

A	B	C	D	E
316,-	412,-	460,-	516,-	608,-
F	G	H	I	L
562,-	408,-	432,-	725,-	829,-

Benötigt | Required



649.20.351 Unterputz-Ventil 1/2", Einbaukörper

- rechtsschließend, ker. Scheiben

Concealed wall valve 1/2", body

- clockwise closure, ceramic discs

A	B	C	D	E
74,-				



649.20.356 Unterputz-Ventil 1/2", Einbaukörper

- linksschließend, ker. Scheiben

Concealed wall valve 1/2", body

- counter-clockwise closure, cer. discs

649.20.451 Unterputz-Ventil 3/4", Einbaukörper

- rechtsschließend, ker. Scheiben

Concealed wall valve 3/4", body

- clockwise closure, ceramic discs

A	B	C	D	E
102,-				

649.20.456 Unterputz-Ventil 3/4", Einbaukörper

- linksschließend, ker. Scheiben

Concealed wall valve 3/4", body











- counter-clockwise closure, cer. discs

EMPIRE ROYAL

Maßzeichnungen unter www.joerger.de - Menü SERVICE.
 Technical specifications under www.joerger.de - menu SERVICE.

A chrom chrome	[.000]	E platin matt platinum matt	[.066]
B silbernickel polished nickel	[.035]	F nerz matt milk matt	[.096]
C nerz milk	[.095]	G schwarz-matt black matt	[.092]
C nickel matt satin nickel	[.036]	G weiß-matt white matt	[.052]
D edelmessing sunshine	[.040]	H bronze bronze	[.011]
D platin platinum	[.065]	I gold gold	[.020]
E edelmess.matt sunshine matt	[.041]	L roségold rosegold	[.022]
E gold matt gold matt	[.021]	L roségold matt rosegold matt	[.023]

Unterputz-Thermostat/Ventil-Modul | Concealed thermostatic/wall-valve modul









			A	B	C	D	E
	621.60.432	Unterputz-Ventil-Modul Fertigmontageset ■ Griff ■ Rosette	288,-	375,-	418,-	470,-	553,-
	Concealed wall-valve-modul assembly set ■ design handle ■ escutcheon						
	Benötigt Required			F	G	H	I
			511,-	438,-	454,-	659,-	754,-
	649.20.610	Unterputz-Ventil-Modul, 1-fach ■ 1x Spindelventil 3/4", rechtsschließend mit keram. Scheiben ■ 2 Abgänge 1/2", je 1x rechts/links möglich, gleichzeitig benutzbar	229,-				
	Concealed wall-valve-modul, single ■ 1x spindle valve 3/4", clockwise closure with ceramic discs ■ 2 outlets 1/2", each 1x right/left possible, simultaneously usable						
	Benötigt Required			A			
	649.20.620	Unterputz-Ventil-Modul, 2-fach ■ 2x Spindelventil 3/4", rechtsschließend mit keram. Scheiben ■ 4 Abgänge 1/2", je 2x rechts/links möglich, gleichzeitig benutzbar ■ im Verbund maßgenaue Montage ■ erweiterbar mit 649.20.610	458,-				
	Concealed wall-valve-modul, double ■ 2x spindle valve 3/4", clockwise closure with ceramic discs ■ 4 outlets 1/2", each 2x right/left possible, simultaneously usable ■ precise assembly due to composite ■ expandable with 649.20.610						
	Benötigt Required			A			
	649.20.630	Unterputz-Ventil-Modul, 3-fach ■ 3x Spindelventil 3/4", rechtsschließend mit keram. Scheiben ■ 6 Abgänge 1/2", je 3x rechts/links möglich, gleichzeitig benutzbar ■ im Verbund maßgenauen Montage ■ erweiterbar mit 649.20.610	686,-				
	Concealed wall-valve-modul, triple ■ 3x spindle valve 3/4", clockwise closure with ceramic discs ■ 6 outlets 1/2", each 3x right/left possible, simultaneously usable ■ precise assembly due to composite ■ expandable with 649.20.610						
	Benötigt Required			A			
	626.40.460	Unterputz-Thermostat 1/2" ohne Mengenregulierung, Fertigmontageset ■ Funktionseinheit ohne Umstellung und ohne Absperrung ■ Durchflussrate 25,8 l/min bei 3 bar	929,-	1.078,-	1.184,-	1.316,-	1.577,-
	Concealed wall thermostat 1/2" without flow control, assembly set ■ Functional unit without diverter and without shut-off ■ flow rate 25,8 l/min at 3 bar						
	Benötigt Required			F	G	H	I
			1.469,-	1.280,-	1.428,-	1.691,-	2.244,-
	649.20.612	Anschlußadapter 1/2" ■ Anschlußadapter, Abschlußstopfen ■ passend zu Einbaubox 649.40.360	122,-				
	Connection adapter 1/2" ■ connection adapter, end plug ■ matching to wall box 649.40.360						
	Benötigt Required			A			
	649.40.360	Unterputz-Einbaubox 1/2" ■ zu Fertigmontageset 626.40.460 ■ für Nass- und Trockenbau geeignet	168,-				
	Concealed wall box 1/2" ■ for assembly set 626.40.460 ■ for wetwall and drywall construction						
	Benötigt Required			A			
	626.40.555	Unterputz-Thermostat 3/4" ohne Mengenregulierung, Fertigmontageset ■ serienbezogener Temperiergriff ■ Sicherheitssperre bei 38° C	577,-	648,-	736,-	779,-	942,-
	Concealed wall thermostat 3/4" without flow control, assembly set ■ design handle for temp. control ■ locking device at 38° C						
	Benötigt Required			F	G	H	I
			846,-	782,-	949,-	1.262,-	1.676,-
	649.20.634	Anschlußadapter 3/4" ■ Anschlußadapter, Abschlußstopfen ■ passend zu Einbaukörper 649.40.555	146,-				
	Connection adapter 3/4" ■ connection adapter, end plug ■ matching to wall body 649.40.555						
	Benötigt Required			A			
	649.40.555	Unterputz-Einbaukörper 3/4" ■ zu Fertigmontageset 626.40.555 ■ Kartusche mit Schmutzfängsieben ■ für Nass- und Trockenbau geeignet ■ Durchflussrate 64,2 l/min bei 3 bar ■ ohne Absperrung	1.636,-				
	Concealed thermostat body 3/4" ■ for assembly set 626.40.555 ■ cartridge with filter screens ■ for wetwall and drywall construction ■ flow rate 64,2 l/min at 3 bar ■ without shut-off						
	Benötigt Required			A			

EMPIRE ROYAL

Maßzeichnungen unter www.joerger.de - Menü SERVICE.
 Technical specifications under www.joerger.de - menu SERVICE.

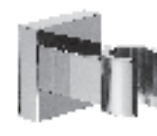
A chrom chrome	[.000]	E platin matt platinum matt	[.066]
B silbernickel polished nickel	[.035]	F nerz matt milk matt	[.096]
C nerz milk	[.095]	G schwarz-matt black matt	[.092]
C nickel matt satin nickel	[.036]	G weiß-matt white matt	[.052]
D edelmessing sunshine	[.040]	H bronze bronze	[.011]
D platin platinum	[.065]	I gold gold	[.020]
E edelmess.matt sunshine matt	[.041]	L roségold rosegold	[.022]
E gold matt gold matt	[.021]	L roségold matt rosegold matt	[.023]

Brausen | Showers

		A	B	C	D	E			
	626.13.300 Duschgarnitur, komplett <ul style="list-style-type: none"> Wandrohr 760 mm, mit Schieber Metall-Handbrause mit Anti-Kalk-System und Rückflussverhinderer Metall-Brauseschlauch 1750 mm, beidseitig mit drehbarem Konus 	Shower bar set, complete <ul style="list-style-type: none"> wall bar 760 mm, with slider metal hand shower with anticalc. system and backflow preventer metal shower hose 1750 mm, both sides with turning cone 		494,-	692,-	885,-	989,-	1.296,-	
			F	G	H	I	L		
		1.149,-	1.098,-	1.689,-	1.742,-	3.014,-			
	626.13.350 Duschstange, lose <ul style="list-style-type: none"> Wandrohr 760 mm, mit Schieber 	Shower bar, separate <ul style="list-style-type: none"> wall bar 760 mm, with slider 		326,-	485,-	576,-	679,-	869,-	
			F	G	H	I	L		
		796,-	628,-	929,-	1.138,-	1.866,-			
	626.13.210 Schlauchbrausegarnitur <ul style="list-style-type: none"> Wandanschlußbogen 1/2", Schubrosette Wand-Brausehalter Metall-Handbrause mit Anti-Kalk-System und Rückflussverhinderer Metall-Brauseschlauch 1500 mm, beidseitig mit drehbarem Konus 	Shower combination <ul style="list-style-type: none"> wall elbow connection 1/2", escutcheon wall fitting for hand shower metal hand shower with anticalc. system and backflow preventer metal shower hose 1500 mm, both sides with turning cone 		348,-	495,-	583,-	688,-	994,-	
			F	G	H	I	L		
		828,-	756,-	1.096,-	1.262,-	1.919,-			
	626.13.155 Wandanschlußbogen 1/2", ohne Haken <ul style="list-style-type: none"> Brauseabgang 1/2" mit Rückflussverhinderer, Rosette 	Wall elbow connection 1/2", without cradle <ul style="list-style-type: none"> discharge 1/2" with backflow preventer, escutcheon 		145,-	162,-	184,-	209,-	249,-	
			F	G	H	I	L		
		227,-	218,-	238,-	296,-	385,-			
	649.13.220 Wand-Brausehalter	Wall fitting for hand shower		179,-	206,-	238,-	262,-	314,-	
			F	G	H	I	L		
		292,-	212,-	278,-	390,-	479,-			
	626.13.237 Hygienebrausegarnitur <ul style="list-style-type: none"> Wandbrausehalter und -anschlußbogen 1/2", Schubrosette Hygienebrause, quadratisch (649.13.334), komplett aus Metall einstrahlig, Bedienung über Druckhebel Metall-Brauseschlauch 1250 mm 	Ablution spray combination <ul style="list-style-type: none"> wall fitting and elbow connection 1/2" spray handshower, square (649.13.334), completely metal one jet, push-lever operation flexible metal shower hose 1250 mm 		409,-	548,-	696,-	748,-	867,-	
			F	G	H	I	L		
		798,-	795,-	1.118,-	1.212,-	1.649,-			
	626.20.237 1-Hand Batterie 1/2" für Hygienebrause, Fertigmontageset <ul style="list-style-type: none"> Rosette, Griff 	Concealed single lever 1/2" for ablution spray, assembly set <ul style="list-style-type: none"> escutcheon, handle 		271,-	342,-	439,-	496,-	594,-	
			F	G	H	I	L		
		567,-	532,-	612,-	690,-	819,-			
Benötigt Required									
	649.20.237 Unterputz 1-Hand Batterie 1/2", Einbaukörper <ul style="list-style-type: none"> Kartusche mit keramischen Scheiben zu Fertigmontageset 626.20.237 	Single lever mixer 1/2", concealed body <ul style="list-style-type: none"> cartridge with ceramic discs for assembly set 626.20.237 		125,-	169,-	208,-	229,-	268,-	
			F	G	H	I	L		
		249,-	224,-	258,-	329,-	396,-			

EMPIRE ROYAL

Maßzeichnungen unter www.joerger.de - Menü SERVICE.
 Technical specifications under www.joerger.de - menu SERVICE.

A chrom chrome	[.000]	E platin matt platinum matt	[.066]
B silbernickel polished nickel	[.035]	F nerz matt mink matt	[.096]
C nerz mink	[.095]	G schwarz-matt black matt	[.092]
C nickel matt satin nickel	[.036]	G weiß-matt white matt	[.052]
D edelmessing sunshine	[.040]	H bronze bronze	[.011]
D platin platinum	[.065]	I gold gold	[.020]
E edelmess.matt sunshine matt	[.041]	L roségold rosegold	[.022]
E gold matt gold matt	[.021]	L roségold matt rosegold matt	[.023]

	649.13.975 Regenbrause 1/2", 300 x 300 mm <ul style="list-style-type: none"> ■ Ausführung ganz in Metall ■ 3 mm ultra flach ■ mit Kugelgelenk ■ Anti-Kalk-System ■ <u>ohne Wandarm</u> 	Rain shower head 1/2", 300 x 300 mm <ul style="list-style-type: none"> ■ full metal body ■ 3 mm ultra-thin ■ with ball joint ■ with anticalcareous system ■ <u>without wall bracket</u> 	A	B	C	D	E
			756,-	1.646,-	1.854,-	1.989,-	2.398,-
	<ul style="list-style-type: none"> ■ weitere, zur Serie passende Kopfbrausen siehe Kapitel "Brausen" 	<ul style="list-style-type: none"> ■ for further shower heads matching this collection see chapter "showers" 	F	G	H	I	L
			2.296,-	1.854,-	2.368,-	2.896,-	3.568,-

Empfohlen | Recommended

	649.13.785 Wandarm 1/2" <ul style="list-style-type: none"> ■ Ausladung 350 mm 	Wall bracket 1/2" <ul style="list-style-type: none"> ■ projection 350 mm 	A	B	C	D	E
			198,-	264,-	318,-	346,-	456,-
	<ul style="list-style-type: none"> ■ weitere, zur Serie passende Wandarme siehe Kapitel "Brausen" 	<ul style="list-style-type: none"> ■ for further wall brackets matching this collection see chapter "showers" 	F	G	H	I	L
			399,-	334,-	436,-	518,-	740,-

	649.13.771 Deckenanbindung 1/2" <ul style="list-style-type: none"> ■ Länge 150 mm 	Ceiling bracket 1/2" <ul style="list-style-type: none"> ■ length 150 mm 	A	B	C	D	E
			176,-	292,-	350,-	395,-	462,-
	<ul style="list-style-type: none"> ■ weitere, zur Serie passende Deckenanbindungen siehe Kapitel "Brausen" 	<ul style="list-style-type: none"> ■ for further ceiling brackets matching this collection see chapter "showers" 	F	G	H	I	L
			446,-	350,-	442,-	558,-	836,-

	649.13.526 Seitenbrause 1/2" <ul style="list-style-type: none"> ■ Rosette 125 x 125 mm, Wandmontage ■ Brausekopf schwenkbar, 20° ■ Anti-Kalk-System ■ Ausführung Kunststoff 	Body spray side shower 1/2" <ul style="list-style-type: none"> ■ escutcheon 125 x 125 mm, wall assembly ■ swivel shower head, 20° ■ anticalcareous system ■ plastic 	A	B	C	D	E
			186,-	329,-	384,-	406,-	542,-
	<ul style="list-style-type: none"> ■ weitere, zur Serie passende Seitenbrausen siehe Kapitel "Brausen" 	<ul style="list-style-type: none"> ■ for further side showers matching this collection see chapter "showers" 	F	G	H	I	L
			508,-	392,-	472,-	659,-	944,-

	649.13.375 Handbrause 1/2" <ul style="list-style-type: none"> ■ Ausführung Metall ■ Anti-Kalk-System ■ Anschluß 1/2" 	Hand shower 1/2" <ul style="list-style-type: none"> ■ brass ■ anticalcareous system ■ connection 1/2" 	A	B	C	D	E
			168,-	212,-	288,-	324,-	379,-
	<ul style="list-style-type: none"> ■ weitere, zur Serie passende Handbrausen siehe Kapitel "Brausen" 	<ul style="list-style-type: none"> ■ for further hand showers matching this collection see chapter "showers" 	F	G	H	I	L
			352,-	314,-	392,-	439,-	629,-

EMPIRE ROYAL

Maßzeichnungen unter www.joerger.de - Menü SERVICE.
 Technical specifications under www.joerger.de - menu SERVICE.

A chrom chrome	[.000]	E platin matt platinum matt	[.066]
B silbernickel polished nickel	[.035]	F nerz matt milk matt	[.096]
C nerz milk	[.095]	G schwarz-matt black matt	[.092]
C nickel matt satin nickel	[.036]	G weiß-matt white matt	[.052]
D edelmessing sunshine	[.040]	H bronze bronze	[.011]
D platin platinum	[.065]	I gold gold	[.020]
E edelmess.matt sunshine matt	[.041]	L roségold rosegold	[.022]
E gold matt gold matt	[.021]	L roségold matt rosegold matt	[.023]

Accessoires für Handtücher | Accessories for towels

	626.00.002 Handtuchhalter ■ Rohr starr, ca. 415 mm	Towel bar ■ rigid bar, approx. 415 mm	A	B	C	D	E
			125,-	182,-	236,-	266,-	312,-
			F	G	H	I	L
			289,-	236,-	290,-	376,-	678,-

	627.00.047 Handtuchring ■ 220 x 105 mm ■ geschlossene Ausführung	Towel ring ■ 220 x 105 mm ■ closed version	A	B	C	D	E
			138,-	199,-	259,-	292,-	342,-
			F	G	H	I	L
			318,-	285,-	319,-	414,-	746,-

	626.00.022 Handtuchhaken	Robe hanger	A	B	C	D	E
			59,-	84,-	89,-	96,-	116,-
			F	G	H	I	L
			108,-	98,-	112,-	156,-	268,-

	626.00.040 Badetuchhalter ■ ca. 770 mm	Bath towel bar ■ approx. 770 mm	A	B	C	D	E
			189,-	324,-	459,-	519,-	772,-
			F	G	H	I	L
			666,-	335,-	616,-	986,-	1.432,-

	626.00.031 Wannengriff ■ ca. 305 mm	Tub handle ■ approx. 305 mm	A	B	C	D	E
			124,-	192,-	264,-	298,-	436,-
			F	G	H	I	L
			378,-	278,-	416,-	556,-	872,-

	626.00.030 Duschtürgriff ■ ca. 600 mm	Shower door handle ■ approx. 600 mm	A	B	C	D	E
			316,-	475,-	599,-	669,-	929,-
			F	G	H	I	L
			819,-	639,-	889,-	1.199,-	1.929,-

	634.00.104 Gästehandtuchkorb, eckig ■ mit Ablage ■ Korbgröße 260 x 150 x 190 mm	Guest towel basket, angular ■ with shelf ■ basket size 260 x 150 x 190 mm	A	B	C	D	E
			230,-	314,-	356,-	389,-	528,-
			F	G	H	I	L
			466,-	492,-	675,-	849,-	1.499,-

EMPIRE ROYAL

Maßzeichnungen unter www.joerger.de - Menü SERVICE.
 Technical specifications under www.joerger.de - menu SERVICE.

A chrom chrome	[.000]	E platin matt platinum matt	[.066]
B silbernickel polished nickel	[.035]	F nerz matt mink matt	[.096]
C nerz mink	[.095]	G schwarz-matt black matt	[.092]
C nickel matt satin nickel	[.036]	G weiß-matt white matt	[.052]
D edelmessing sunshine	[.040]	H bronze bronze	[.011]
D platin platinum	[.065]	I gold gold	[.020]
E edelmess.matt sunshine matt	[.041]	L roségold rosegold	[.022]
E gold matt gold matt	[.021]	L roségold matt rosegold matt	[.023]

Accessoires für Waschplatz | Accessories for washstands

	627.00.007 Seifenhalter, komplett ■ Seifenschale aus Kristallglas ■ Ausrichtung nach rechts ■ Auf Wunsch ist die Ausrichtung auch nach links möglich	Soap dish holder, complete ■ crystal glass dish ■ right side alignment ■ on request, the alignment is also possible to the left	A	B	C	D	E
			114,-	189,-	225,-	242,-	324,-
			F	G	H	I	L
			285,-	176,-	238,-	356,-	479,-
	727.00.307 Seifenschale, lose	Glass dish, separate	A				
			34,-				
	627.00.017 Seifenhalter, komplett ■ Standmodell ■ Seifenschale aus Kristallglas, seidenmatt	Soap dish holder, complete ■ free standing version ■ crystal glass dish, frosted	A	B	C	D	E
			94,-	117,-	129,-	144,-	184,-
			F	G	H	I	L
			164,-	172,-	234,-	282,-	366,-
	627.00.006 Lotionsspender, komplett ■ Wandmodell ■ Ausführung Metall	Soap dispenser, complete ■ wall version ■ brass	A	B	C	D	E
			319,-	395,-	459,-	495,-	664,-
			F	G	H	I	L
			594,-	499,-	658,-	738,-	1.179,-
	626.00.016 Lotionsspender, komplett ■ Standmodell ■ Ausführung Metall	Soap dispenser, complete ■ free standing version ■ brass	A	B	C	D	E
			289,-	354,-	426,-	459,-	612,-
			F	G	H	I	L
			548,-	464,-	606,-	679,-	1.082,-
	634.00.105 Schwammkorb ■ rechteckig, 260 x 130 mm	Sponge basket ■ rectangular, 260 x 130 mm	A	B	C	D	E
			199,-	238,-	279,-	332,-	462,-
			F	G	H	I	L
			396,-	348,-	459,-	589,-	859,-
	634.00.106 Eckschwammkorb ■ 195 x 195 mm	Corner sponge basket ■ 195 x 195 mm	A	B	C	D	E
			195,-	234,-	275,-	328,-	458,-
			F	G	H	I	L
			390,-	344,-	455,-	585,-	855,-

EMPIRE ROYAL

Maßzeichnungen unter www.joerger.de - Menü SERVICE.
 Technical specifications under www.joerger.de - menu SERVICE.

A chrom chrome	[.000]	E platin matt platinum matt	[.066]
B silbernickel polished nickel	[.035]	F nerz matt milk matt	[.096]
C nerz milk	[.095]	G schwarz-matt black matt	[.092]
C nickel matt satin nickel	[.036]	G weiß-matt white matt	[.052]
D edelmessing sunshine	[.040]	H bronze bronze	[.011]
D platin platinum	[.065]	I gold gold	[.020]
E edelmess.matt sunshine matt	[.041]	L roségold rosegold	[.022]
E gold matt gold matt	[.021]	L roségold matt rosegold matt	[.023]

	627.00.036 Glashalter, komplett ■ Glas aus Kristallglas, seidenmatt ■ Ausrichtung nach links ■ Auf Wunsch ist die Ausrichtung auch nach rechts möglich	Tumbler holder, complete ■ crystal glass tumbler, frosted ■ left side alignment ■ on request, the alignment is also possible to the right	A	B	C	D	E
			116,-	192,-	228,-	245,-	326,-
			F	G	H	I	L
			288,-	179,-	240,-	359,-	482,-
	727.00.336 Mundglas, seidenmatt, lose	Glass tumbler, frosted, separate	A				
			54,-				

	627.00.046 Glashalter, komplett ■ Standmodell ■ Glas aus Kristallglas, seidenmatt	Tumbler holder, complete ■ free standing version ■ crystal glass tumbler, frosted	A	B	C	D	E
			96,-	115,-	127,-	142,-	182,-
			F	G	H	I	L
			162,-	174,-	236,-	284,-	364,-

Accessoires für WC-Bühler | Accessories for w.c. bowl

	626.00.014 Papierhalter ■ beweglicher Bügel	Toilet paper roll holder ■ mobile bracket	A	B	C	D	E
			179,-	214,-	264,-	289,-	398,-
			F	G	H	I	L
			352,-	319,-	519,-	756,-	986,-

	626.00.015 Reserve-Papierhalter	Spare toilet paper roll holder	A	B	C	D	E
			116,-	159,-	205,-	225,-	310,-
			F	G	H	I	L
			275,-	188,-	299,-	349,-	544,-

	627.00.000 Klosettbürstengarnitur, komplett ■ wandhängendes Modell ■ Bürstentopf aus Metall	Toilet brush holder set, complete ■ suspended model ■ brush holder out of brass	A	B	C	D	E
			238,-	327,-	399,-	435,-	592,-
			F	G	H	I	L
			526,-	509,-	749,-	964,-	1.352,-

	677.00.053 Bürstenstange, komplett, lose	Brush rod with brush, separate	A	B	C	D	E
			84,-	114,-	139,-	152,-	208,-
			F	G	H	I	L
			184,-	178,-	262,-	332,-	472,-

	799.00.236 Bürstenkopf, lose	Brush, separate	A				
			22,-				

EMPIRE ROYAL

Maßzeichnungen unter www.joerger.de - Menü SERVICE.
 Technical specifications under www.joerger.de - menu SERVICE.

A chrom chrome	[.000]	E platin matt platinum matt	[.066]
B silbernickel polished nickel	[.035]	F nerz matt mink matt	[.096]
C nerz mink	[.095]	G schwarz-matt black matt	[.092]
C nickel matt satin nickel	[.036]	G weiß-matt white matt	[.052]
D edelmessing sunshine	[.040]	H bronze bronze	[.011]
D platin platinum	[.065]	I gold gold	[.020]
E edelmess.matt sunshine matt	[.041]	L roségold rosegold	[.022]
E gold matt gold matt	[.021]	L roségold matt rosegold matt	[.023]



627.00.001 Klosettbürstengarnitur, komplett
 ■ stehendes Modell
 ■ Bürstentopf aus Metall

Toilet brush holder set, complete
 ■ floor standing model
 ■ brush holder out of brass

A	B	C	D	E
198,-	286,-	359,-	395,-	552,-
F	G	H	I	L
486,-	469,-	709,-	924,-	1.312,-

Spiegel | Mirrors



649.00.418 Kosmetikspiegel, beleuchtet
 ■ schwenk- und ausziehbar
 ■ 3-fache Vergrößerung
 ■ Direktanschluss
 ■ Spiegeldurchmesser 185 mm
 ■ Rahmendurchmesser 250 mm
 ■ Kalt-, Warm- und Taglicht durch Piezzo-Schalter umschaltbar

Cosmetic mirror, incl. lighting
 ■ swivelling and extendable
 ■ magnification 3:1
 ■ direct connection
 ■ mirror diameter 185 mm
 ■ frame diameter 250 mm
 ■ cold, warm and day light switchable by Piezzo switch

A	B	C	D	E
556,-	988,-	1.214,-	1.418,-	1.828,-
F	G	H	I	L
1.684,-	1.214,-	1.549,-	2.138,-	2.998,-



Oberflächen | colours

Folgende Oberflächen sind bei dieser Serie möglich |
The following colours are possible with this collection

chrom	chrome	[.000] PG A
silbernickel	polished nickel	[.035] PG B
nerz	mink	[.095] PG C
nickel matt	satin nickel	[.036] PG C
edelmessing	sunshine	[.040] PG D
platin	platinum	[.065] PG D
edelmessing matt	sunshine matt	[.041] PG E
gold matt	gold matt	[.021] PG E
platin matt	platinum matt	[.066] PG E
nerz matt	mink matt	[.096] PG F
schwarz matt	black matt	[.092] PG G
weiß matt	white matt	[.052] PG G
bronze	bronze	[.011] PG H
gold	gold	[.020] PG I
roségold	rosegold	[.022] PG L
roségold matt	rosegold matt	[.023] PG L

Andere Oberflächen auf Anfrage |
Different colours on request

Auf Anfrage können wir Produkte von Drittanbietern auch gerne passend zu unseren Oberflächen veredeln (vorbehaltlich der Eignungsprüfung) | Third-party products may be plated matching to our colours on request (subject to valuation of suitability)

Waschtisch | Washbasin

ab Seite | from page 084

Bidet | Bidet

ab Seite | from page 085

Wanne | Bath tub

ab Seite | from page 086

Dusche | Shower

ab Seite | from page 087

Accessoires | Accessories

ab Seite | from page 092

Maßzeichnungen unter www.joerger.de - Menü SERVICE.
 Technical specifications under www.joerger.de - menu SERVICE.

A chrom chrome	[.000]	E platin matt platinum matt	[.066]
B silbernickel polished nickel	[.035]	F nerz matt mink matt	[.096]
C nerz mink	[.095]	G schwarz-matt black matt	[.092]
C nickel matt satin nickel	[.036]	G weiß-matt white matt	[.052]
D edelmessing sunshine	[.040]	H bronze bronze	[.011]
D platin platinum	[.065]	I gold gold	[.020]
E edelmess.matt sunshine matt	[.041]	L roségold rosegold	[.022]
E gold matt gold matt	[.021]	L roségold matt rosegold matt	[.023]

Waschtisch Batterien | Washbasin mixer

	623.30.300 Waschtisch 3-Loch Batterie 1/2" <ul style="list-style-type: none"> ■ Ausladung 158 mm; Höhe 170 mm ■ 2 Seitenrandventile mit keramischen Oberteilen 1/2", rechts und links schließend ■ Ablaufventil mit Klickverschluss 1 1/4" ■ empfohlen: 2x 649.15.530 - Kupferrohr 300 mm 	Washbasin 3-hole mixer 1/2" <ul style="list-style-type: none"> ■ spout projection 158 mm; height 170 mm ■ 2 side valves with ceramic internal upper parts 1/2", clockwise and counter-clockwise closure ■ push-open waste 1 1/4" ■ recommended: 2x 649.15.530 - copper tube 300 	A	B	C	D	E
			1.788,-	2.094,-	2.399,-	2.585,-	3.034,-
			F	G	H	I	L
			2.820,-	2.428,-	2.708,-	3.546,-	4.084,-

	623.10.333 Waschtisch 1-Hand Batterie <ul style="list-style-type: none"> ■ Ausladung 158 mm; Höhe 240 mm ■ Kartusche mit ker. Scheiben ■ Ablaufventil mit Klickverschluss 1 1/4" ■ 2 Druckschläuche M10x1 x ø10 x 450 mm 	Single lever washbasin mixer <ul style="list-style-type: none"> ■ spout projection 158 mm; height 240 mm ■ cartridge with ceramic discs ■ push-open waste 1 1/4" ■ 2 pressure hoses M10x1 x ø10 x 450 mm 	A	B	C	D	E
			1.128,-	1.374,-	1.569,-	1.632,-	1.988,-
			F	G	H	I	L
			1.878,-	1.769,-	2.046,-	2.352,-	3.042,-

Variante | Alternative

623.10.334 Waschtisch 1-Hand Batterie <ul style="list-style-type: none"> ■ <u>ohne</u> Ablaufventil 	Single lever washbasin mixer <ul style="list-style-type: none"> ■ <u>without</u> waste 	A	B	C	D	E
		1.066,-	1.274,-	1.426,-	1.532,-	1.884,-
		F	G	H	I	L
		1.710,-	1.670,-	1.865,-	2.138,-	2.518,-

	623.10.332 Waschtisch 1-Hand Batterie <ul style="list-style-type: none"> ■ mit Rohrverlängerung 150 mm ■ Ausladung 158 mm; Höhe 390 mm ■ 2 Druckschläuche M10x1 x 600 mm ■ <u>ohne</u> Ablaufventil 	Single lever washbasin mixer <ul style="list-style-type: none"> ■ with body extension 150 mm ■ spout projection 158 mm; height 390 mm ■ 2 pressure hoses M10x1 x 600 mm ■ <u>without</u> waste 	A	B	C	D	E
			1.372,-	1.519,-	1.798,-	1.979,-	2.374,-
			F	G	H	I	L
			2.192,-	1.939,-	2.509,-	2.836,-	3.559,-

Wand-Waschtisch 1-Hand Batterien | Single lever wall-washbasin mixer

	623.20.366 Wand-Waschtisch 1-Hand Batterie 1/2", Fertigmontageset <ul style="list-style-type: none"> ■ Ausladung 200 - 214 mm ■ Standard 1-Hand Kartusche ■ Steckperlator 28 x 7 ■ Wandrosette 	Single lever wall washbasin mixer 1/2", assembly set <ul style="list-style-type: none"> ■ projection 200 - 214 mm ■ standard single lever cartridge ■ plug aerator 28 x 7 ■ escutcheon 	A	B	C	D	E
			922,-	1.068,-	1.208,-	1.308,-	1.572,-
			F	G	H	I	L
			1.422,-	1.356,-	1.544,-	1.722,-	2.624,-

Benötigt | Required

	649.20.362 Wand-Waschtisch 1-Hand Batterie 1/2", Einbaukörper <ul style="list-style-type: none"> ■ zu Fertigmontageset 623.20.366 ■ Kartusche mit ker. Scheiben 	Single lever wall washbasin mixer 1/2", concealed body <ul style="list-style-type: none"> ■ for assembly set 623.20.366 ■ cartridge with ceramic discs 	A				
			258,-				

Maßzeichnungen unter www.joerger.de - Menü SERVICE.
 Technical specifications under www.joerger.de - menu SERVICE.

A chrom chrome	[.000]	E platin matt platinum matt	[.066]
B silbernickel polished nickel	[.035]	F nerz matt mink matt	[.096]
C nerz mink	[.095]	G schwarz-matt black matt	[.092]
C nickel matt satin nickel	[.036]	G weiß-matt white matt	[.052]
D edelmessing sunshine	[.040]	H bronze bronze	[.011]
D platin platinum	[.065]	I gold gold	[.020]
E edelmess.matt sunshine matt	[.041]	L roségold rosegold	[.022]
E gold matt gold matt	[.021]	L roségold matt rosegold matt	[.023]

	623.20.360 Wand-Waschtisch 1-Hand Batterie 1/2", Fertigmontageset	Single lever wall washbasin mixer 1/2", assembly set	A	B	C	D	E
	<ul style="list-style-type: none"> ■ Ausladung 183 - 208 mm ■ Progressive 180° Kartusche ■ Steckperlator 28 x 7 ■ Wandrosette 	<ul style="list-style-type: none"> ■ projection 183 - 208 mm ■ progressive 180° cartridge ■ plug aerator 28 x 7 ■ escutcheon 	948,-	1.149,-	1.298,-	1.399,-	1.766,-
			F	G	H	I	L
			1.522,-	1.452,-	1.648,-	2.046,-	2.782,-

Benötigt | Required

	649.20.370 Wand-Waschtisch 1-Hand Batterie 1/2", Einbaukörper	Single lever wall washbasin mixer 1/2", concealed body	A				
	<ul style="list-style-type: none"> ■ zu Fertigmontageset 623.20.360 ■ Keramisches Oberteil mit 180° Drehwinkel, Absperrung und stufenloser Temperaturregelung 	<ul style="list-style-type: none"> ■ for assembly set 623.20.360 ■ Ceramic cartridge with 180° angle of rotation, shut-off and continuous temperature control 	429,-				

	623.30.360 Wand-Waschtisch 3-Loch Batterie 1/2", Fertigmontageset	Wall washbasin 3-hole mixer 1/2", assembly set	A	B	C	D	E
	<ul style="list-style-type: none"> ■ Wand-Auslauf, Ausladung 190 - 230 mm ■ Griff, Rosette ■ Oberteile 1/2", keramische Scheiben 	<ul style="list-style-type: none"> ■ wall spout, projection 190 - 230 mm ■ design handle, escutcheon ■ cartridges 1/2", with ceramic discs 	945,-	1.168,-	1.206,-	1.258,-	1.454,-
			F	G	H	I	L
			1.324,-	1.239,-	1.476,-	1.589,-	2.689,-

Benötigt | Required

	649.30.380 Wand-Waschtisch 3-Loch Batterie 1/2", Einbaukörper	Wall washbasin 3-hole mixer 1/2", concealed body	A				
	<ul style="list-style-type: none"> ■ 2 Anschlüsse, Stichmaß 204 mm ■ zu Fertigmontageset 623.30.360 	<ul style="list-style-type: none"> ■ 2 connections, center distance 204 mm ■ for assembly set 623.30.360 	296,-				

Bidet Batterie | Bidet mixer

	623.10.111 Bidet 1-Hand Batterie	Single lever bidet mixer	A	B	C	D	E
	<ul style="list-style-type: none"> ■ Ausladung 110 mm; Höhe 240 mm ■ Kartusche mit ker. Scheiben ■ Ablaufventil mit Klickverschluß 1 1/4" ■ 2 Druckschläuche M10x1 x ø10 x 450 mm 	<ul style="list-style-type: none"> ■ spout projection 110 mm; height 240 mm ■ cartridge with ceramic discs ■ push-open waste 1 1/4" ■ 2 pressure hoses M10x1 x ø10 x 450 mm 	1.176,-	1.410,-	1.569,-	1.664,-	2.022,-
			F	G	H	I	L
			1.910,-	1.804,-	2.082,-	2.389,-	3.075,-

Zubehör für Waschtisch- und Bidet-Batterien | Supplies for washbasin and bidet mixer

	626.12.100 Eckventil 1/2"	Angle valve 1/2"	A	B	C	D	E
	<ul style="list-style-type: none"> ■ Ausladung 100 mm ■ Fettkammer-Innenoberteil 1/2" ■ Quetschverschraubung ■ Schubrosette 	<ul style="list-style-type: none"> ■ projection 100 mm ■ cartridge 1/2" ■ compression joint ■ escutcheon 	145,-	196,-	248,-	296,-	448,-
			F	G	H	I	L
			392,-	265,-	424,-	529,-	698,-

	649.15.530 Kupferrohr, 300 mm	Copper tube, 300 mm	A	B	C	D	E
	<ul style="list-style-type: none"> ■ mit Bördel, für Quetschverschraubung 	<ul style="list-style-type: none"> ■ with flange, for compression joint 	15,-	38,-	55,-	62,-	74,-
			F	G	H	I	L
			69,-	75,-	94,-	112,-	169,-

Variante | Alternative

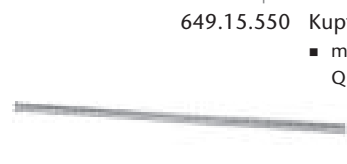
	649.15.550 Kupferrohr, 500 mm	Copper tube, 500 mm	A	B	C	D	E
	<ul style="list-style-type: none"> ■ mit Bördel, für Quetschverschraubung 	<ul style="list-style-type: none"> ■ with flange, for compression joint 	20,-	58,-	77,-	87,-	102,-
			F	G	H	I	L
			97,-	77,-	96,-	134,-	219,-

TURN

Maßzeichnungen unter www.joerger.de - Menü SERVICE.
 Technical specifications under www.joerger.de - menu SERVICE.

A chrom chrome	[.000]	E platin matt platinum matt	[.066]
B silbernickel polished nickel	[.035]	F nerz matt mink matt	[.096]
C nerz mink	[.095]	G schwarz-matt black matt	[.092]
C nickel matt satin nickel	[.036]	G weiß-matt white matt	[.052]
D edelmessing sunshine	[.040]	H bronze bronze	[.011]
D platin platinum	[.065]	I gold gold	[.020]
E edelmess.matt sunshine matt	[.041]	L roségold rosegold	[.022]
E gold matt gold matt	[.021]	L roségold matt rosegold matt	[.023]

	649.15.380 Waschtisch-Tassensiphon 1 ¼“ ■ massive, eckige Ausführung ■ Rosette ■ Abgangsrohr ø 32 mm	Washbasin cupped siphon trap 1 ¼“ ■ heavy brass, square design ■ escutcheon ■ outlet tube ø 32 mm	A	B	C	D	E
			289,-	349,-	423,-	440,-	569,-
			F	G	H	I	L
			492,-	497,-	642,-	739,-	925,-

	649.15.290 Zwangsablaufventil ■ Schaftlänge 70 mm ■ für Waschbecken ohne Überlauf	Restraint drain/waste ■ length of shaft 70 mm ■ for washbasins without overflow	A	B	C	D	E
			93,-	116,-	172,-	192,-	255,-
			F	G	H	I	L
			224,-	247,-	414,-	464,-	612,-

Badewanne, Stand-Batterien | Bath tub mixer sets, deck mount

	623.40.100 4-Loch Wannenfüll- u. Brausebatterie ½“, für Standmontage ■ Ausladung 182 mm; Höhe 205 mm ■ 2 Seitenrandventile mit keramischen Oberteilen ½“, rechts und links schließend ■ Metall-Brauseschlauch 2000 mm ■ Metall-Handbrause mit Anti-Kalk-System und Rückflussverhinderer	Tube/shower mixer set ½“ deck mount ■ spout projection 182 mm; height 205 mm ■ 2 side valves, ceramic internal upper parts ½“, clockwise and counter-clockwise closure ■ metal shower hose 2000 mm ■ metal hand shower with anticalc.	A	B	C	D	E
			2.949,-	3.275,-	3.568,-	3.798,-	4.556,-
			F	G	H	I	L
			3.998,-	3.622,-	3.779,-	5.155,-	5.819,-

Variante | Alternative

	623.40.150 4-Loch Wannenrandkombination ½“ ■ für Ab- und Überlaufgarnitur mit Wanneneinlauf, ohne Rohrunterbrecher ■ Seitenrandventile, 2-Wege Umstellung ■ Metall-Brauseschlauch 2000 mm ■ Montageplatte 649.40.160.000 wird empfohlen	Tube/shower combination ½“ ■ for waste and overflow set with bath tub filler spout, without pipe interrupter ■ side valves, 2-position diverter ■ metal shower hose 2000 mm ■ Assembly plate 649.40.160.000 recommended	A	B	C	D	E
			1.898,-	2.152,-	2.340,-	2.474,-	2.808,-
			F	G	H	I	L
			2.610,-	2.384,-	2.960,-	3.118,-	3.808,-

Empfohlen | Recommended

	649.40.160 Montageplatte, komplett ■ für 4-Loch Armaturen ■ Druckschläuche ½“ x ½“ x 600 mm ■ empfohlen: Schlauchkastensystem siehe Kapitel “Serienübergreifendes”	Assembly plate, complete ■ for deck mounted tub/shower mixer ■ pressure hoses ½“x ½“ x 600 mm ■ recommended: system with hose box see chapter “universal products”	A				
			308,-				

	623.10.820 Wannen 1-Hand Batterie ■ für freistehende Montage ■ Ausladung 182 mm ■ Umstellung Wanne/Brause ■ Metall-Handbrause mit Anti-Kalk-System und Rückflussverhinderer ■ Metall-Brauseschlauch 1500 mm ■ Standrohr mit Befestigungsflansch ■ Luftsprudler ■ Kartusche mit keramischen Scheiben ■ Höhe gesamt 850 - 930 mm ■ Höhe bis Auslauf 755 - 835 mm	Tube/shower mixer set ■ free standing assembly ■ spout projection 182 mm ■ diverter spout/hand shower ■ metal hand shower with anticalc. system and backflow preventer ■ metal shower hose 1500 mm ■ Pillar tube with flange ■ aerator ■ ceramic internal upper part ■ height 850 - 930 mm ■ outlet height 755 - 835 mm	A	B	C	D	E
			3.388,-	4.239,-	4.596,-	4.814,-	5.726,-
			F	G	H	I	L
			5.248,-	4.657,-	5.486,-	6.299,-	6.642,-

Benötigt | Required

	649.10.970 Bausatz-Vormontage ■ Bodenplatte mit Befestigungsset ■ zu Fertigmontageset 623.10.820	Assembly set for pre-installation ■ joint plate with fixing set ■ for assembly set 623.10.820	A				
			549,-				

Maßzeichnungen unter www.joerger.de - Menü SERVICE.
 Technical specifications under www.joerger.de - menu SERVICE.

A chrom chrome	[.000]	E platin matt platinum matt	[.066]
B silbernickel polished nickel	[.035]	F nerz matt milk matt	[.096]
C nerz milk	[.095]	G schwarz-matt black matt	[.092]
C nickel matt satin nickel	[.036]	G weiß-matt white matt	[.052]
D edelmessing sunshine	[.040]	H bronze bronze	[.011]
D platin platinum	[.065]	I gold gold	[.020]
E edelmess.matt sunshine matt	[.041]	L roségold rosegold	[.022]
E gold matt gold matt	[.021]	L roségold matt rosegold matt	[.023]



626.11.100 Wand-Wanneneinlauf ¾“
 ■ Ausladung 200 - 212 mm
 ■ Steckanschluß-Montage

Tub wall spout ¾“
 ■ spout projection 200 - 212 mm
 ■ special concealed wall attachment

A	B	C	D	E
446,-	546,-	596,-	686,-	758,-
F	G	H	I	L
728,-	798,-	776,-	888,-	1.069,-

Unterputz-Hebelmischer ½“ | Concealed single lever mixer ½“



623.20.125 1-Hand Wannenfüll- und Brause-
 batterie ½“ für UP-Montage,
 Fertigmontageset
 ■ manuelle, keramische Umstellung für
 druckunabhängige Funktion
 ■ **mit** Sicherheitseinrichtung
 ■ Durchflußrate 21 l/min bei 3 bar

Concealed single lever wall tub
 and shower mixer ½“,
 assembly set
 ■ manual, ceramic diverter tub/shower
 for pressure-independent function
 ■ **with** safety device
 ■ flow rate 21 l/min at 3 bar

A	B	C	D	E
839,-	948,-	1.218,-	1.305,-	1.588,-
F	G	H	I	L
1.468,-	1.194,-	1.338,-	1.709,-	2.097,-

Variante | Alternative



623.20.235 1-Hand Brausebatterie ½“ für UP-
 Montage, Fertigmontageset
 ■ **ohne** Umstellung
 ■ Funktionseinheit mit ker. Scheiben
 ■ Durchflußrate 20,4 l/min bei 3 bar

Concealed single lever shower
 mixer ½“, assembly set
 ■ **without** diverter
 ■ functional unit with ceramic discs
 ■ flow rate 20,4 l/min at 3 bar

A	B	C	D	E
662,-	786,-	979,-	1.074,-	1.334,-
F	G	H	I	L
1.226,-	995,-	1.148,-	1.448,-	1.784,-

Benötigt | Required



649.40.360 Unterputz-Einbaubox ½“
 ■ zu Fertigmontageset 623.20.125 und
 623.20.235
 ■ für Nass- und Trockenbau geeignet

Concealed wall box ½“
 ■ for assembly set 623.20.125 and
 623.20.235
 ■ for wetwall and drywall construction

A	B	C	D	E
168,-				

Unterputz-Thermostate ½“ | Wall thermostats, concealed ½“



626.40.380 Unterputz-Thermostat ½“
mit Mengenregulierung,
 Fertigmontageset
 ■ manuelle, keramische Umstellung
 Wanne/Brause, druckunabhängig
 ■ mit Sicherheitseinrichtung
 ■ Durchflußrate 20,4 l/min bei 3 bar

Concealed wall thermostat ½“
with flow control,
 assembly set
 ■ manual, ceramic diverter tub/shower
 for pressure-independent function
 ■ with safety device
 ■ flow rate 20,4 l/min at 3 bar

A	B	C	D	E
1.179,-	1.342,-	1.436,-	1.545,-	1.829,-
F	G	H	I	L
1.718,-	1.466,-	1.638,-	1.949,-	2.508,-

Variante | Alternative



626.40.360 Unterputz-Thermostat ½“
mit Mengenregulierung,
 Fertigmontageset
 ■ **ohne** Umstellung
 ■ mit integrierter keramischer
 Mengenregulierung
 ■ Durchflußrate 20,4 l/min bei 3 bar

Concealed wall thermostat ½“
with flow control,
 assembly set
 ■ **without** diverter
 ■ with integrated ceramic cartridge for
 volume control
 ■ flow rate 20,4 l/min at 3 bar

A	B	C	D	E
1.145,-	1.308,-	1.399,-	1.510,-	1.794,-
F	G	H	I	L
1.664,-	1.432,-	1.599,-	1.915,-	2.474,-

Variante | Alternative



626.40.460 Unterputz-Thermostat ½“
ohne Mengenregulierung,
 Fertigmontageset
 ■ Funktionseinheit **ohne** Umstellung
 und **ohne** Absperrung
 ■ Durchflußrate 25,8 l/min bei 3 bar

Concealed wall thermostat ½“
without flow control,
 assembly set
 ■ Functional unit **without** diverter and
without shut-off
 ■ flow rate 25,8 l/min at 3 bar

A	B	C	D	E
929,-	1.078,-	1.184,-	1.316,-	1.577,-
F	G	H	I	L
1.469,-	1.280,-	1.428,-	1.691,-	2.244,-

Benötigt | Required



649.40.360 Unterputz-Einbaubox ½“
 ■ zu Fertigmontageset 626.40.360,
 626.40.380 und 626.40.460
 ■ für Nass- und Trockenbau geeignet

Concealed wall box ½“
 ■ for assembly set 626.40.360,
 626.40.380 and 626.40.460
 ■ for wetwall and drywall construction

A	B	C	D	E
168,-				

Maßzeichnungen unter www.joerger.de - Menü SERVICE.
 Technical specifications under www.joerger.de - menu SERVICE.

A chrom chrome	[.000]	E platin matt platinum matt	[.066]
B silbernickel polished nickel	[.035]	F nerz matt mink matt	[.096]
C nerz mink	[.095]	G schwarz-matt black matt	[.092]
C nickel matt satin nickel	[.036]	G weiß-matt white matt	[.052]
D edelmessing sunshine	[.040]	H bronze bronze	[.011]
D platin platinum	[.065]	I gold gold	[.020]
E edelmess.matt sunshine matt	[.041]	L roségold rosegold	[.022]
E gold matt gold matt	[.021]	L roségold matt rosegold matt	[.023]

Unterputz-Thermostat 3/4" mit hohem Durchfluß | Wall thermostat, concealed 3/4" with high flow



626.40.555 Unterputz-Thermostat 3/4" ohne Mengenregulierung, Fertigmontageset

- serienbezogener Temperiergriff
- Sicherheitssperre bei 38° C

Concealed wall thermostat 3/4" without flow control, assembly set

- design handle for temp. control
- locking device at 38°C

A	B	C	D	E
577,-	648,-	736,-	779,-	942,-
F	G	H	I	L
846,-	782,-	949,-	1.262,-	1.676,-

Benötigt | Required



649.40.555 Unterputz-Einbaukörper 3/4"

- zu Fertigmontageset 626.40.555
- Kartusche mit Schmutzfangsieben
- für Nass- und Trockenbau geeignet
- Durchflussrate 64,2 l/min bei 3 bar
- ohne Absperrung

Concealed thermostat body 3/4"

- for assembly set 626.40.555
- cartridge with filter screens
- for wetwall and drywall construction
- flow rate 64,2 l/min at 3 bar
- without shut-off

A	B	C	D	E
1.636,-				

Unterputz-Thermostat 3/4" | Wall thermostat, concealed 3/4"



626.40.520 Unterputz-Thermostat 3/4" ohne Mengenregulierung, Fertigmontageset

- serienbezogener Temperiergriff
- Sicherheitssperre bei 38° C

Concealed wall thermostat 3/4" without flow control, assembly set

- design handle for temp. control
- locking device at 38°C

A	B	C	D	E
577,-	648,-	736,-	779,-	942,-
F	G	H	I	L
846,-	782,-	949,-	1.262,-	1.676,-

Benötigt | Required



649.40.520 Unterputz-Einbaukörper 3/4"

- zu Fertigmontageset 626.40.520
- Kartusche mit Schmutzfangsieben
- für Nass- und Trockenbau geeignet
- Durchflussrate 41 l/min bei 3 bar
- ohne Absperrung

Concealed thermostat body 3/4"

- for assembly set 626.40.520
- cartridge with filter screens
- for wetwall and drywall construction
- flow rate 41 l/min at 3 bar
- without shut-off

A	B	C	D	E
498,-				

Unterputz-Umstellung und Ventile | Diverter and valves concealed



623.40.650 Unterputz 3-Wege Umstellung 1/2" Fertigmontageset

- Griff
- Hülse, Schubrosette

Concealed 3-position diverter 1/2" assembly set

- design handle
- socket with adjustable escutcheon

A	B	C	D	E
352,-	412,-	452,-	494,-	595,-
F	G	H	I	L
552,-	549,-	614,-	734,-	944,-

Benötigt | Required



649.40.600 Unterputz 3-Wege Umstellung 1/2" Einbaukörper

- zu Fertigmontageset 623.40.650

Concealed 3-position diverter 1/2" diverter body

- for assembly set 623.40.650

A	B	C	D	E
236,-				



623.50.234 Unterputz-Ventil Fertigmontageset

- Griff
- Hülse, Schubrosette

Concealed wall valve assembly set

- design handle
- socket with adjustable escutcheon

A	B	C	D	E
352,-	412,-	452,-	494,-	595,-
F	G	H	I	L
552,-	549,-	614,-	734,-	944,-

649.20.350 Unterputz-Ventil 1/2", Einbaukörper

- rechtsschließend, ker. Scheiben

Concealed wall valve 1/2", body

- clockwise closure, ceramic discs

A	B	C	D	E
66,-				



649.20.355 Unterputz-Ventil 1/2", Einbaukörper

- linksschließend, ker. Scheiben

Concealed wall valve 1/2", body

- counter-clockwise closure, cer. discs

649.20.450 Unterputz-Ventil 3/4", Einbaukörper

- rechtsschließend, ker. Scheiben

Concealed wall valve 3/4", body

- clockwise closure, ceramic discs

A	B	C	D	E
99,-				



649.20.455 Unterputz-Ventil 3/4", Einbaukörper

- linksschließend, ker. Scheiben











Concealed wall valve 3/4", body

- counter-clockwise closure, cer. discs

Maßzeichnungen unter www.joerger.de - Menü SERVICE.
 Technical specifications under www.joerger.de - menu SERVICE.

A chrom chrome	[.000]	E platin matt platinum matt	[.066]
B silbernickel polished nickel	[.035]	F nerz matt milk matt	[.096]
C nerz milk	[.095]	G schwarz-matt black matt	[.092]
C nickel matt satin nickel	[.036]	G weiß-matt white matt	[.052]
D edelmessing sunshine	[.040]	H bronze bronze	[.011]
D platin platinum	[.065]	I gold gold	[.020]
E edelmess.matt sunshine matt	[.041]	L roségold rosegold	[.022]
E gold matt gold matt	[.021]	L roségold matt rosegold matt	[.023]

Unterputz-Thermostat/Ventil-Modul | Concealed thermostatic/wall-valve modul









			A	B	C	D	E	
	623.60.432	Unterputz-Ventil-Modul Fertigmontageset ■ Griff ■ Rosette	Concealed wall-valve-modul assembly set ■ design handle ■ escutcheon	335,-	392,-	429,-	469,-	566,-
	Benötigt Required			F	G	H	I	L
				524,-	522,-	584,-	699,-	899,-
	649.20.610	Unterputz-Ventil-Modul, 1-fach ■ 1x Spindelventil 3/4", rechts-schließend mit keram. Scheiben ■ 2 Abgänge 1/2", je 1x rechts/links möglich, gleichzeitig benutzbar	Concealed wall-valve-modul, single ■ 1x spindle valve 3/4", clockwise closure with ceramic discs ■ 2 outlets 1/2", each 1x right/left possible, simultaneously usable	A				
				229,-				
	649.20.620	Unterputz-Ventil-Modul, 2-fach ■ 2x Spindelventil 3/4", rechts-schließend mit keram. Scheiben ■ 4 Abgänge 1/2", je 2x rechts/links möglich, gleichzeitig benutzbar ■ im Verbund maßgenaue Montage ■ erweiterbar mit 649.20.610	Concealed wall-valve-modul, double ■ 2x spindle valve 3/4", clockwise closure with ceramic discs ■ 4 outlets 1/2", each 2x right/left possible, simultaneously usable ■ precise assembly due to composite ■ expandable with 649.20.610	A				
				458,-				
	649.20.630	Unterputz-Ventil-Modul, 3-fach ■ 3x Spindelventil 3/4", rechts-schließend mit keram. Scheiben ■ 6 Abgänge 1/2", je 3x rechts/links möglich, gleichzeitig benutzbar ■ im Verbund maßgenauen Montage ■ erweiterbar mit 649.20.610	Concealed wall-valve-modul, triple ■ 3x spindle valve 3/4", clockwise closure with ceramic discs ■ 6 outlets 1/2", each 3x right/left possible, simultaneously usable ■ precise assembly due to composite ■ expandable with 649.20.610	A				
				686,-				
	626.40.460	Unterputz-Thermostat 1/2" <u>ohne</u> Mengenregulierung, Fertigmontageset ■ Funktionseinheit <u>ohne</u> Umstellung und <u>ohne</u> Absperrung ■ Durchflussrate 25,8 l/min bei 3 bar	Concealed wall thermostat 1/2" <u>without</u> flow control, assembly set ■ Functional unit <u>without</u> diverter and <u>without</u> shut-off ■ flow rate 25,8 l/min at 3 bar	A	B	C	D	E
				929,-	1.078,-	1.184,-	1.316,-	1.577,-
	Benötigt Required			F	G	H	I	L
			1.469,-	1.280,-	1.428,-	1.691,-	2.244,-	
	649.20.612	Anschlußadapter 1/2" ■ Anschlußadapter, Abschlußstopfen ■ passend zu Einbaubox 649.40.360	Connection adapter 1/2" ■ connection adapter, end plug ■ matching to wall box 649.40.360	A				
				122,-				
	649.40.360	Unterputz-Einbaubox 1/2" ■ zu Fertigmontageset 626.40.460 ■ für Nass- und Trockenbau geeignet	Concealed wall box 1/2" ■ for assembly set 626.40.460 ■ for wetwall and drywall construction	A				
				168,-				
	626.40.555	Unterputz-Thermostat 3/4" <u>ohne</u> Mengenregulierung, Fertigmontageset ■ serienbezogener Temperiergriff ■ Sicherheitssperre bei 38° C	Concealed wall thermostat 3/4" <u>without</u> flow control, assembly set ■ design handle for temp. control ■ locking device at 38° C	A	B	C	D	E
				577,-	648,-	736,-	779,-	942,-
	Benötigt Required			F	G	H	I	L
			846,-	782,-	949,-	1.262,-	1.676,-	
	649.20.634	Anschlußadapter 3/4" ■ Anschlußadapter, Abschlußstopfen ■ passend zu Einbaukörper 649.40.555	Connection adapter 3/4" ■ connection adapter, end plug ■ matching to wall body 649.40.555	A				
				146,-				
	649.40.555	Unterputz-Einbaukörper 3/4" ■ zu Fertigmontageset 626.40.555 ■ Kartusche mit Schmutzfangsieben ■ für Nass- und Trockenbau geeignet ■ Durchflussrate 64,2 l/min bei 3 bar ■ <u>ohne</u> Absperrung	Concealed thermostat body 3/4" ■ for assembly set 626.40.555 ■ cartridge with filter screens ■ for wetwall and drywall construction ■ flow rate 64,2 l/min at 3 bar ■ <u>without</u> shut-off	A				
				1.636,-				

TURN

Maßzeichnungen unter www.joerger.de - Menü SERVICE.
 Technical specifications under www.joerger.de - menu SERVICE.

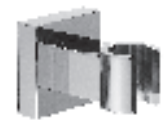
A chrom chrome	[.000]	E platin matt platinum matt	[.066]
B silbernickel polished nickel	[.035]	F nerz matt milk matt	[.096]
C nerz milk	[.095]	G schwarz-matt black matt	[.092]
C nickel matt satin nickel	[.036]	G weiß-matt white matt	[.052]
D edelmessing sunshine	[.040]	H bronze bronze	[.011]
D platin platinum	[.065]	I gold gold	[.020]
E edelmess.matt sunshine matt	[.041]	L roségold rosegold	[.022]
E gold matt gold matt	[.021]	L roségold matt rosegold matt	[.023]

Bräusen | Showers

		A	B	C	D	E	
	626.13.300 Duschgarnitur, komplett	Shower bar set, complete					
	<ul style="list-style-type: none"> Wandrohr 760 mm, mit Schieber Metall-Handbrause mit Anti-Kalk-System und Rückflussverhinderer Metall-Brauseschlauch 1750 mm, beidseitig mit drehbarem Konus 	<ul style="list-style-type: none"> wall bar 760 mm, with slider metal hand shower with anticalc. system and backflow preventer metal shower hose 1750 mm, both sides with turning cone 					
		494,-	692,-	885,-	989,-	1.296,-	
		F	G	H	I	L	
		1.149,-	1.098,-	1.689,-	1.742,-	3.014,-	
	626.13.350 Duschstange, lose	Shower bar, separate					
	<ul style="list-style-type: none"> Wandrohr 760 mm, mit Schieber 	<ul style="list-style-type: none"> wall bar 760 mm, with slider 					
		326,-	485,-	576,-	679,-	869,-	
		F	G	H	I	L	
		796,-	628,-	929,-	1.138,-	1.866,-	
	626.13.210 Schlauchbrausegarnitur	Shower combination					
	<ul style="list-style-type: none"> Wandanschlußbogen 1/2", Schubrosette Wand-Brausehalter Metall-Handbrause mit Anti-Kalk-System und Rückflussverhinderer Metall-Brauseschlauch 1500 mm, beidseitig mit drehbarem Konus 	<ul style="list-style-type: none"> wall elbow connection 1/2", escutcheon wall fitting for hand shower metal hand shower with anticalc. system and backflow preventer metal shower hose 1500 mm, both sides with turning cone 					
		348,-	495,-	583,-	688,-	994,-	
		F	G	H	I	L	
		828,-	756,-	1.096,-	1.262,-	1.919,-	
	626.13.155 Wandanschlußbogen 1/2", ohne Haken	Wall elbow connection 1/2", without cradle					
	<ul style="list-style-type: none"> Brauseabgang 1/2" mit Rückflussverhinderer, Rosette 	<ul style="list-style-type: none"> discharge 1/2" with backflow preventer, escutcheon 					
		145,-	162,-	184,-	209,-	249,-	
		F	G	H	I	L	
		227,-	218,-	238,-	296,-	385,-	
	649.13.220 Wand-Brausehalter	Wall fitting for hand shower					
		179,-	206,-	238,-	262,-	314,-	
		F	G	H	I	L	
		292,-	212,-	278,-	390,-	479,-	
	626.13.237 Hygienebrausegarnitur	Ablution spray combination					
	<ul style="list-style-type: none"> Wandbrausehalter und -anschlußbogen 1/2", Schubrosette Hygienebrause, quadratisch (649.13.334), komplett aus Metall einstrahlig, Bedienung über Druckhebel Metall-Brauseschlauch 1250 mm 	<ul style="list-style-type: none"> wall fitting and elbow connection 1/2" spray handshower, square (649.13.334), completely metal one jet, push-lever operation flexible metal shower hose 1250 mm 					
		409,-	548,-	696,-	748,-	867,-	
		F	G	H	I	L	
		798,-	795,-	1.118,-	1.212,-	1.649,-	
	623.20.237 1-Hand Batterie 1/2" für Hygiene-Brause, Fertigmontageset	Concealed single lever 1/2" for ablution spray, assembly set					
	<ul style="list-style-type: none"> Rosette, Griff 	<ul style="list-style-type: none"> escutcheon, handle 					
		299,-	379,-	496,-	568,-	726,-	
		F	G	H	I	L	
		624,-	585,-	658,-	832,-	959,-	
Benötigt Required							
	649.20.237 Unterputz 1-Hand Batterie 1/2", Einbaukörper	Single lever mixer 1/2", concealed body					
	<ul style="list-style-type: none"> Kartusche mit keramischen Scheiben zu Fertigmontageset 623.20.237 	<ul style="list-style-type: none"> cartridge with ceramic discs for assembly set 623.20.237 					
		125,-	169,-	208,-	229,-	268,-	
		F	G	H	I	L	
		249,-	224,-	258,-	329,-	396,-	

TURN

Maßzeichnungen unter www.joerger.de - Menü SERVICE.
 Technical specifications under www.joerger.de - menu SERVICE.

A chrom chrome	[.000]	E platin matt platinum matt	[.066]
B silbernickel polished nickel	[.035]	F nerz matt milk matt	[.096]
C nerz milk	[.095]	G schwarz-matt black matt	[.092]
C nickel matt satin nickel	[.036]	G weiß-matt white matt	[.052]
D edelmessing sunshine	[.040]	H bronze bronze	[.011]
D platin platinum	[.065]	I gold gold	[.020]
E edelmess.matt sunshine matt	[.041]	L roségold rosegold	[.022]
E gold matt gold matt	[.021]	L roségold matt rosegold matt	[.023]



649.13.975 Regenbrause ½“, 300 x 300 mm Rain shower head ½“, ø 300 mm

- | | |
|---|--|
| <ul style="list-style-type: none"> ■ Ausführung ganz in Metall ■ 3 mm ultra flach ■ mit Kugelgelenk ■ Anti-Kalk-System ■ <u>ohne Wandarm</u> | <ul style="list-style-type: none"> ■ full metal body ■ 3 mm ultra-thin ■ with ball joint ■ with anticalcareous system ■ <u>without wall bracket</u> |
| <ul style="list-style-type: none"> ■ weitere, zur Serie passende Kopfbrausen siehe Kapitel "Brausen" | <ul style="list-style-type: none"> ■ for further shower heads matching this collection see chapter "showers" |

A	B	C	D	E
756,-	1.646,-	1.854,-	1.989,-	2.398,-
F	G	H	I	L
2.296,-	1.854,-	2.368,-	2.896,-	3.568,-

Empfohlen | Recommended



649.13.785 Wandarm ½“ Wall bracket ½“

- | | |
|--|---|
| <ul style="list-style-type: none"> ■ Ausladung 350 mm ■ weitere, zur Serie passende Wandarme siehe Kapitel "Brausen" | <ul style="list-style-type: none"> ■ projection 350 mm ■ for further wall brackets matching this collection see chapter "showers" |
|--|---|

A	B	C	D	E
198,-	264,-	318,-	346,-	456,-
F	G	H	I	L
399,-	334,-	436,-	518,-	740,-



649.13.771 Deckenanbindung ½“ Ceiling bracket ½“

- | | |
|---|--|
| <ul style="list-style-type: none"> ■ Länge 150 mm ■ weitere, zur Serie passende Deckenanbindungen siehe Kapitel "Brausen" | <ul style="list-style-type: none"> ■ length 150 mm ■ for further ceiling brackets matching this collection see chapter "showers" |
|---|--|

A	B	C	D	E
176,-	292,-	350,-	395,-	462,-
F	G	H	I	L
446,-	350,-	442,-	558,-	836,-



649.13.526 Seitenbrause ½“ Body spray side shower ½“

- | | |
|---|--|
| <ul style="list-style-type: none"> ■ Rosette 125 x 125 mm, Wandmontage ■ Brausekopf schwenkbar, 20° ■ Anti-Kalk-System ■ Ausführung Kunststoff ■ weitere, zur Serie passende Seitenbrausen siehe Kapitel "Brausen" | <ul style="list-style-type: none"> ■ escutcheon 125 x 125 mm, wall assembly ■ swivel shower head, 20° ■ anticalcareous system ■ plastic ■ for further side showers matching this collection see chapter "showers" |
|---|--|

A	B	C	D	E
186,-	329,-	384,-	406,-	542,-
F	G	H	I	L
508,-	392,-	472,-	659,-	944,-



649.13.525 Handbrause ½“ Hand shower ½“

- | | |
|--|---|
| <ul style="list-style-type: none"> ■ Ausführung Metall ■ Anti-Kalk-System ■ Anschluß ½“ | <ul style="list-style-type: none"> ■ brass ■ anticalcareous system ■ connection ½“ |
|--|---|

A	B	C	D	E
168,-	212,-	288,-	324,-	379,-
F	G	H	I	L
352,-	314,-	392,-	439,-	629,-

TURN

Maßzeichnungen unter www.joerger.de - Menü SERVICE.
 Technical specifications under www.joerger.de - menu SERVICE.

A chrom chrome	[.000]	E platin matt platinum matt	[.066]
B silbernickel polished nickel	[.035]	F nerz matt mink matt	[.096]
C nerz mink	[.095]	G schwarz-matt black matt	[.092]
C nickel matt satin nickel	[.036]	G weiß-matt white matt	[.052]
D edelmessing sunshine	[.040]	H bronze bronze	[.011]
D platin platinum	[.065]	I gold gold	[.020]
E edelmess.matt sunshine matt	[.041]	L roségold rosegold	[.022]
E gold matt gold matt	[.021]	L roségold matt rosegold matt	[.023]

Accessoires für Handtücher | Accessories for towels

	623.00.002 Handtuchhalter ■ Rohr starr, ca. 415 mm	Towel bar ■ rigid bar, approx. 415 mm	A	B	C	D	E
			189,-	266,-	296,-	319,-	399,-
			F	G	H	I	L
			362,-	369,-	458,-	446,-	789,-

	623.00.022 Handtuchhaken	Robe hanger	A	B	C	D	E
			129,-	188,-	206,-	218,-	275,-
			F	G	H	I	L
			248,-	209,-	260,-	316,-	398,-

	623.00.040 Badetuchhalter ■ ca. 770 mm	Bath towel bar ■ approx. 770 mm	A	B	C	D	E
			335,-	579,-	646,-	768,-	978,-
			F	G	H	I	L
			884,-	632,-	789,-	1.187,-	1.596,-

	623.00.030 Duschtürgriff ■ ca. 560 mm	Shower door handle ■ approx. 560 mm	A	B	C	D	E
			742,-	1.069,-	1.156,-	1.264,-	1.559,-
			F	G	H	I	L
			1.388,-	1.158,-	1.412,-	1.852,-	2.552,-

	623.00.031 Wannengriff ■ ca. 305 mm	Tub handle ■ approx. 305 mm	A	B	C	D	E
			284,-	529,-	549,-	592,-	698,-
			F	G	H	I	L
			648,-	512,-	618,-	814,-	1.038,-

	623.00.047 Handtuchring ■ 220 x 105 mm ■ geschlossene Ausführung	Towel ring ■ 220 x 105 mm ■ closed version	A	B	C	D	E
			198,-	274,-	335,-	364,-	499,-
			F	G	H	I	L
			442,-	352,-	408,-	562,-	759,-

	634.00.104 Gästehandtuchkorb, eckig ■ mit Ablage ■ Korbgröße 260 x 150 x 190 mm	Guest towel basket, angular ■ with shelf ■ basket size 260 x 150 x 190 mm	A	B	C	D	E
			230,-	314,-	356,-	389,-	528,-
			F	G	H	I	L
			466,-	492,-	675,-	849,-	1.499,-

Maßzeichnungen unter www.joerger.de - Menü SERVICE.
 Technical specifications under www.joerger.de - menu SERVICE.

A chrom chrome	[.000]	E platin matt platinum matt	[.066]
B silbernickel polished nickel	[.035]	F nerz matt milk matt	[.096]
C nerz milk	[.095]	G schwarz-matt black matt	[.092]
C nickel matt satin nickel	[.036]	G weiß-matt white matt	[.052]
D edelmessing sunshine	[.040]	H bronze bronze	[.011]
D platin platinum	[.065]	I gold gold	[.020]
E edelmess.matt sunshine matt	[.041]	L roségold rosegold	[.022]
E gold matt gold matt	[.021]	L roségold matt rosegold matt	[.023]

Accessoires für Waschplatz | Accessories for washstands

	623.00.007 Seifenhalter, komplett ■ Seifenschale aus Kristallglas ■ Ausrichtung nach rechts ■ Auf Wunsch ist die Ausrichtung auch nach links möglich	Soap dish holder, complete ■ crystal glass dish ■ right side alignment ■ on request, the alignment is also possible to the left	A	B	C	D	E
			293,-	395,-	464,-	523,-	597,-
			F	G	H	I	L
			570,-	464,-	565,-	717,-	819,-

726.00.307 Seifenschale, lose Glass dish, separate	A				
	84,-				

	623.00.006 Lotionspender, komplett ■ Wandmodell ■ Ausführung Metall	Soap dispenser, complete ■ wall version ■ brass	A	B	C	D	E
			476,-	699,-	790,-	762,-	927,-
			F	G	H	I	L
			886,-	790,-	916,-	974,-	1.392,-

	626.00.016 Lotionspender, komplett ■ Standmodell ■ Ausführung Metall	Soap dispenser, complete ■ free standing version ■ brass	A	B	C	D	E
			289,-	354,-	426,-	459,-	612,-
			F	G	H	I	L
			548,-	464,-	606,-	679,-	1.082,-

	634.00.105 Schwammkorb ■ rechteckig, 260 x 130 mm	Sponge basket ■ rectangular, 260 x 130 mm	A	B	C	D	E
			199,-	238,-	279,-	332,-	462,-
			F	G	H	I	L
			396,-	348,-	459,-	589,-	859,-

	634.00.106 Eckschwammkorb ■ 195 x 195 mm	Corner sponge basket ■ 195 x 195 mm	A	B	C	D	E
			195,-	234,-	275,-	328,-	458,-
			F	G	H	I	L
			390,-	344,-	455,-	585,-	855,-

	623.00.036 Glashalter, komplett ■ Glas aus Kristallglas, seidenmatt ■ Ausrichtung nach links ■ Auf Wunsch ist die Ausrichtung auch nach rechts möglich	Tumbler holder, complete ■ crystal glass tumbler, frosted ■ left side alignment ■ on request, the alignment is also possible to the right	A	B	C	D	E
			348,-	449,-	514,-	574,-	668,-
			F	G	H	I	L
			624,-	485,-	538,-	772,-	878,-

726.00.336 Mundglas, seidenmatt, lose Glass tumbler, frosted, separate	A				
	59,-				

TURN

Maßzeichnungen unter www.joerger.de - Menü SERVICE.
 Technical specifications under www.joerger.de - menu SERVICE.

A chrom chrome	[.000]	E platin matt platinum matt	[.066]
B silbernickel polished nickel	[.035]	F nerz matt mink matt	[.096]
C nerz mink	[.095]	G schwarz-matt black matt	[.092]
C nickel matt satin nickel	[.036]	G weiß-matt white matt	[.052]
D edelmessing sunshine	[.040]	H bronze bronze	[.011]
D platin platinum	[.065]	I gold gold	[.020]
E edelmess.matt sunshine matt	[.041]	L roségold rosegold	[.022]
E gold matt gold matt	[.021]	L roségold matt rosegold matt	[.023]

Accessoires für WC-Bereich | Accessories for w.c. area

	623.00.014 Papierhalter ■ beweglicher Bügel	Toilet paper roll holder ■ mobile bracket	A	B	C	D	E
			413,-	498,-	589,-	663,-	770,-
			F	G	H	I	L
			714,-	630,-	728,-	911,-	1.096,-

	623.00.015 Reserve-Papierhalter	Spare toilet paper roll holder	A	B	C	D	E
			196,-	324,-	356,-	389,-	479,-
			F	G	H	I	L
			424,-	368,-	415,-	567,-	689,-

	623.00.000 Klosettbürstengarnitur, komplett ■ wandhängendes Modell ■ Bürstentopf aus Metall	Toilet brush holder set, complete ■ suspended model ■ brush holder out of brass	A	B	C	D	E
			398,-	578,-	642,-	723,-	828,-
			F	G	H	I	L
			782,-	718,-	936,-	1.085,-	1.548,-

	676.00.053 Bürstenstange, komplett, lose	Brush rod with brush, separate	A	B	C	D	E
			228,-	272,-	294,-	322,-	380,-
			F	G	H	I	L
			348,-	324,-	399,-	434,-	478,-

	799.00.236 Bürstenkopf, lose	Brush, separate	A				
			22,-				

	626.00.001 Klosettbürstengarnitur, komplett ■ stehendes Modell ■ Bürstentopf aus Metall	Toilet brush holder set, complete ■ floor standing model ■ brush holder out of brass	A	B	C	D	E
			198,-	286,-	359,-	395,-	552,-
			F	G	H	I	L
			486,-	469,-	709,-	624,-	1.312,-

Spiegel | Mirrors

	649.00.418 Kosmetikspiegel, beleuchtet ■ schwenk- und ausziehbar ■ 3-fache Vergrößerung ■ Direktanschluss ■ Spiegeldurchmesser 185 mm ■ Rahmendurchmesser 250 mm ■ Kalt-, Warm- und Taglicht durch Piezzo-Schalter umschaltbar	Cosmetic mirror, incl. lighting ■ swivelling and extendable ■ magnification 3:1 ■ direct connection ■ mirror diameter 185 mm ■ frame diameter 250 mm ■ cold, warm and day light switchable by Piezzo switch	A	B	C	D	E
			556,-	988,-	1.214,-	1.418,-	1.828,-
			F	G	H	I	L
			1.684,-	1.214,-	1.549,-	2.138,-	2.998,-

EMPIRE ROYAL CRYSTAL



Oberflächen | colours

Folgende Oberflächen sind bei dieser Serie möglich |
The following colours are possible with this collection

chrom		chrome	[.000]	PG A
silbernickel		polished nickel	[.035]	PG B
nerz		mink	[.095]	PG C
nickel matt		satin nickel	[.036]	PG C
edelmessing		sunshine	[.040]	PG D
platin		platinum	[.065]	PG D
edelmessing matt		sunshine matt	[.041]	PG E
gold matt		gold matt	[.021]	PG E
platin matt		platinum matt	[.066]	PG E
nerz matt		mink matt	[.096]	PG F
schwarz matt		black matt	[.092]	PG G
weiß matt		white matt	[.052]	PG G
bronze		bronze	[.011]	PG H
gold		gold	[.020]	PG I
roségold		rosegold	[.022]	PG L
roségold matt		rosegold matt	[.023]	PG L

Andere Oberflächen auf Anfrage |
Different colours on request

Auf Anfrage können wir Produkte von Drittanbietern auch gerne passend zu unseren Oberflächen veredeln (vorbehaltlich der Eignungsprüfung) | Third-party products may be plated matching to our colours on request (subject to valuation of suitability)

Waschtisch | Washbasin

ab Seite | from page 096

Bidet | Bidet

ab Seite | from page 097

Wanne | Bath tub

ab Seite | from page 098

Dusche | Shower

ab Seite | from page 100

Accessoires | Accessories

ab Seite | from page 106

EMPIRE ROYAL CRYSTAL

Maßzeichnungen unter www.joerger.de - Menü SERVICE.
 Technical specifications under www.joerger.de - menu SERVICE.

A chrom chrome	[.000]	E platin matt platinum matt	[.066]
B silbernickel polished nickel	[.035]	F nerz matt mink matt	[.096]
C nerz mink	[.095]	G schwarz-matt black matt	[.092]
C nickel matt satin nickel	[.036]	G weiß-matt white matt	[.052]
D edelmessing sunshine	[.040]	H bronze bronze	[.011]
D platin platinum	[.065]	I gold gold	[.020]
E edelmess.matt sunshine matt	[.041]	L roségold rosegold	[.022]
E gold matt gold matt	[.021]	L roségold matt rosegold matt	[.023]

- 11 kristall klar | crystal clear
- 12 schwarz | black
- 61 kristall matt | crystal matt
- 62 schwarz matt | black matt

Die Artikelnummer wird um weitere 2 Ziffern erweitert. Beispiel:
 Waschtisch 3-Loch Batterie in chrom mit Griffen in kristall klar:

627.30.300.000-11
 Modell Oberfläche Kristallgriff

The article number needs to be added by 2 additional figures. For example:
 washbasin 3-hole mixer in chrome with handles in crystal clear:



627.30.300.000-11
 model surface crystal handle

Waschtisch Batterien mit Rechteck-Luftsprudler | Washbasin mixer with rectangular aerator



Die nachfolgenden Waschtisch-Armaturen sind mit einem rechteckigen Luftsprudler ausgestattet, welcher das Wasser sanft ins Becken fließen lässt und gleichzeitig wassersparend ausgeführt ist.

The following washbasin mixers are equipped with a rectangular aerator, which allows the water to flow gently into the basin and at the same time is designed to save water.



	626.30.300 Waschtisch 3-Loch Batterie 1/2" <ul style="list-style-type: none"> ■ Exzenter-Ablaufgarnitur mit quadratischem Stopfen ■ Ausladung 155 mm; Höhe 260 mm ■ 2 Seitenrandventile mit keramischen Oberteilen 1/2" ■ empfohlen: 2x 649.15.530 - Kupferrohr 300 mm 	Washbasin 3-hole mixer 1/2" <ul style="list-style-type: none"> ■ pop-up waste square design ■ spout projection 155 mm; height 260 mm ■ 2 side valves with ceramic internal upper parts 1/2" ■ recommended: 2x 649.15.530 - copper tube 300 mm 	A	B	C	D	E
			859,-	1.209,-	1.349,-	1.549,-	1.809,-
			F	G	H	I	L
			1.655,-	1.449,-	1.699,-	2.039,-	2.759,-
<u>Variante Alternative</u>							
	626.30.800 Waschtisch 3-Loch Batterie 1/2" <ul style="list-style-type: none"> ■ Exzenter-Ablaufgarnitur mit rundem Stopfen 	Washbasin 3-hole mixer 1/2" <ul style="list-style-type: none"> ■ pop-up waste round design 	A	B	C	D	E
			769,-	1.138,-	1.275,-	1.475,-	1.735,-
			F	G	H	I	L
			1.579,-	1.375,-	1.678,-	1.964,-	2.685,-

Waschtisch Batterien mit rundem Luftsprudler | Washbasin mixer with round aerator



Die nachfolgenden Waschtisch-Armaturen sind mit einem harmonisch runden Luftsprudler ausgestattet, welcher das Wasser sanft und elegant ins Becken fließen lässt und gleichzeitig wassersparend ausgeführt ist.

The following washbasin mixers are equipped with a harmonious, round aerator, which allows the water to flow gently and elegantly into the basin and at the same time is designed to save water.

	627.30.300 Waschtisch 3-Loch Batterie 1/2" <ul style="list-style-type: none"> ■ Exzenter-Ablaufgarnitur mit quadratischem Stopfen ■ Ausladung 155 mm; Höhe 260 mm ■ 2 Seitenrandventile mit keramischen Oberteilen 1/2" ■ empfohlen: 2x 649.15.530 - Kupferrohr 300 mm 	Washbasin 3-hole mixer 1/2" <ul style="list-style-type: none"> ■ pop-up waste square design ■ spout projection 155 mm; height 260 mm ■ 2 side valves with ceramic internal upper parts 1/2" ■ recommended: 2x 649.15.530 - copper tube 300 mm 	A	B	C	D	E
			1.199,-	1.369,-	1.479,-	1.666,-	1.938,-
			F	G	H	I	L
			1.774,-	1.566,-	1.919,-	2.156,-	2.978,-
<u>Variante Alternative</u>							
	627.30.800 Waschtisch 3-Loch Batterie 1/2" <ul style="list-style-type: none"> ■ Exzenter-Ablaufgarnitur mit rundem Stopfen 	Washbasin 3-hole mixer 1/2" <ul style="list-style-type: none"> ■ pop-up waste round design 	A	B	C	D	E
			1.034,-	1.255,-	1.359,-	1.526,-	1.808,-
			F	G	H	I	L
			1.699,-	1.534,-	1.879,-	2.079,-	2.899,-

EMPIRE ROYAL CRYSTAL

Maßzeichnungen unter www.joerger.de - Menü SERVICE.
 Technical specifications under www.joerger.de - menu SERVICE.

A chrom chrome	[.000]	E platin matt platinum matt	[.066]
B silbernickel polished nickel	[.035]	F nerz matt mink matt	[.096]
C nerz mink	[.095]	G schwarz-matt black matt	[.092]
C nickel matt satin nickel	[.036]	G weiß-matt white matt	[.052]
D edelmessing sunshine	[.040]	H bronze bronze	[.011]
D platin platinum	[.065]	I gold gold	[.020]
E edelmess.matt sunshine matt	[.041]	L roségold rosegold	[.022]
E gold matt gold matt	[.021]	L roségold matt rosegold matt	[.023]

- 11 kristall klar | crystal clear
- 12 schwarz | black
- 61 kristall matt | crystal matt
- 62 schwarz matt | black matt

Die Artikelnummer wird um weitere 2 Ziffern erweitert. Beispiel:
 Waschtisch 3-Loch Batterie in chrom mit Griffen in kristall klar:

627.30.300.000-11
 Modell Oberfläche Kristallgriff

The article number needs to be added by 2 additional figures. For example:
 washbasin 3-hole mixer in chrome with handles in crystal clear:

627.30.300.000-11
 model surface crystal handle



627.30.360 Wand-Waschtisch 3-Loch Batterie 1/2", Fertigmontageset

- Wand-Auslauf, Ausladung 200 - 212 mm
- Griff, Hülse, Schubrosette
- Oberteile 1/2", keramische Scheiben

Wall washbasin 3-hole mixer 1/2", assembly set

- wall spout, projection 200 - 212 mm
- design handle, socket with adjustable escutcheon
- cartridges 1/2", with ceramic discs

A	B	C	D	E
928,-	1.099,-	1.282,-	1.432,-	1.672,-
F	G	H	I	L
1.574,-	1.322,-	1.599,-	2.009,-	2.894,-

Benötigt | Required

649.30.380 Wand-Waschtisch 3-Loch Batterie 1/2", Einbaukörper

- 2 Anschlüsse, Stichmaß 204 mm
- zu Fertigmontageset 627.30.360 und 627.30.365

Wall washbasin 3-hole mixer 1/2", concealed body

- 2 connections, center distance 204 mm
- for assembly set 627.30.360 and 627.30.365

A	B	C	D	E
296,-				

Variante | Alternative

627.30.365 Wand-Waschtisch 3-Loch Batterie 1/2" XXL, Fertigmontageset

- Wand-Auslauf, Ausladung 260 - 272 mm

Wall washbasin 3-hole mixer 1/2" XXL, assembly set

- wall spout, projection 260 - 272 mm



A	B	C	D	E
944,-	1.126,-	1.295,-	1.446,-	1.689,-
F	G	H	I	L
1.612,-	1.335,-	1.609,-	2.029,-	2.922,-

Benötigt | Required

649.30.380 Wand-Waschtisch 3-Loch Batterie 1/2", Einbaukörper

- 2 Anschlüsse, Stichmaß 204 mm
- zu Fertigmontageset 627.30.360 und 627.30.365

Wall washbasin 3-hole mixer 1/2", concealed body

- 2 connections, center distance 204 mm
- for assembly set 627.30.360 and 627.30.365



A	B	C	D	E
296,-				

Bidet Batterien | Bidet mixer

627.30.600 Bidet 3-Loch Batterie 1/2"

- Exzenter-Ablaufgarnitur mit rundem Stopfen
- Ausladung 145 mm; Höhe 120 mm
- 2 Seitenrandventile mit keramischen Oberteilen 1/2"
- Exzenter-Ablaufgarnitur mit quadratischem Stopfen auf Anfrage möglich
- empfohlen:
2x 649.15.530 - Kupferrohr 300 mm



Bidet 3-hole mixer 1/2"

- pop-up waste round design
- spout projection 145 mm; height 120 mm
- 2 side valves with ceramic internal upper parts 1/2"
- pop-up waste with square design possible on request
- recommended:
2x 649.15.530 - copper tube 300 mm

A	B	C	D	E
1.086,-	1.318,-	1.428,-	1.599,-	1.898,-
F	G	H	I	L
1.784,-	1.612,-	1.974,-	2.184,-	3.044,-

EMPIRE ROYAL CRYSTAL

Maßzeichnungen unter www.joerger.de - Menü SERVICE.
 Technical specifications under www.joerger.de - menu SERVICE.

A chrom chrome	[.000]	E platin matt platinum matt	[.066]
B silbernickel polished nickel	[.035]	F nerz matt milk matt	[.096]
C nerz milk	[.095]	G schwarz-matt black matt	[.092]
C nickel matt satin nickel	[.036]	G weiß-matt white matt	[.052]
D edelmessing sunshine	[.040]	H bronze bronze	[.011]
D platin platinum	[.065]	I gold gold	[.020]
E edelmess.matt sunshine matt	[.041]	L roségold rosegold	[.022]
E gold matt gold matt	[.021]	L roségold matt rosegold matt	[.023]

- 11 kristall klar | crystal clear
- 12 schwarz | black
- 61 kristall matt | crystal matt
- 62 schwarz matt | black matt





Die Artikelnummer wird um weitere 2 Ziffern erweitert. Beispiel:
 Waschtisch 3-Loch Batterie in chrom mit Griffen in kristall klar:

627.30.300.000-11
 Modell Oberfläche Kristallgriff



The article number needs to be added by 2 additional figures. For example:
 washbasin 3-hole mixer in chrome with handles in crystal clear:

627.30.300.000-11
 model surface crystal handle

Zubehör für Waschtisch- und Bidet-Batterien | Supplies for washbasin and bidet mixer

	626.12.100 Eckventil 1/2"	<ul style="list-style-type: none"> ■ Ausladung 100 mm ■ Fettkammer-Innenoberteil 1/2" ■ Quetschverschraubung ■ Schubrosette 	Angle valve 1/2"	<ul style="list-style-type: none"> ■ projection 100 mm ■ cartridge 1/2" ■ compression joint ■ escutcheon 	A	B	C	D	E
					145,-	196,-	248,-	296,-	448,-
					F	G	H	I	L
					392,-	265,-	424,-	529,-	698,-
<hr/>									
	649.15.530 Kupferrohr, 300 mm	<ul style="list-style-type: none"> ■ mit Bördel, für Quetschverschraubung 	Copper tube, 300 mm	<ul style="list-style-type: none"> ■ with flange, for compression joint 	A	B	C	D	E
					15,-	38,-	55,-	62,-	74,-
					F	G	H	I	L
					69,-	75,-	94,-	112,-	169,-
<hr/>									
Variante Alternative									
	649.15.550 Kupferrohr, 500 mm	<ul style="list-style-type: none"> ■ mit Bördel, für Quetschverschraubung 	Copper tube, 500 mm	<ul style="list-style-type: none"> ■ with flange, for compression joint 	A	B	C	D	E
					20,-	58,-	77,-	87,-	102,-
					F	G	H	I	L
					97,-	77,-	96,-	134,-	219,-
<hr/>									
	649.15.380 Waschtisch-Tassensiphon 1 1/4"	<ul style="list-style-type: none"> ■ massive, eckige Ausführung ■ Rosette ■ Abgangsrohr ø 32 mm 	Washbasin cupped siphon trap 1 1/4"	<ul style="list-style-type: none"> ■ heavy brass, square design ■ escutcheon ■ outlet tube ø 32 mm 	A	B	C	D	E
					289,-	349,-	423,-	440,-	569,-
					F	G	H	I	L
					492,-	497,-	642,-	739,-	925,-
<hr/>									
	649.15.290 Zwangsablaufventil	<ul style="list-style-type: none"> ■ Schaftlänge 70 mm ■ für Waschbecken ohne Überlauf 	Restraint drain/waste	<ul style="list-style-type: none"> ■ length of shaft 70 mm ■ for washbasins without overflow 	A	B	C	D	E
					93,-	116,-	172,-	192,-	255,-
					F	G	H	I	L
					224,-	247,-	414,-	464,-	612,-

Badewanne, Stand-Batterien | Bath tub mixer sets, deck mount

	626.40.100 4-Loch Wannenfüll- und Brausebatterie 1/2", für Standmontage	<ul style="list-style-type: none"> ■ Ausladung 215 mm; Höhe 285 mm ■ 2 Seitenrandventile mit keramischen Oberteilen 1/2", ■ Metall-Brauseschlauch 2000 mm ■ Metall-Handbrause mit Anti-Kalk-System und Rückflussverhinderer 	Tub/shower mixer set 1/2", deck mount	<ul style="list-style-type: none"> ■ spout projection 215 mm; height 285 mm ■ 2 side valves, 1/2" cer. internal upper parts, metal shower hose 2000 mm ■ metal hand shower with anticalc. system and backflow preventer 	A	B	C	D	E
					1.575,-	1.849,-	2.099,-	2.309,-	2.619,-
					F	G	H	I	L
					2.536,-	2.049,-	2.665,-	3.154,-	3.659,-
<hr/>									
Empfohlen Recommended									
	649.40.160 Montageplatte, komplett	<ul style="list-style-type: none"> ■ für 4-Loch Armaturen ■ Druckschläuche 1/2" x 1/2" x 600 mm ■ empfohlen: Schlauchkastensystem siehe Kapitel "Serienübergreifendes" 	Assembly plate, complete	<ul style="list-style-type: none"> ■ for deck mounted tub/shower mixer ■ pressure hoses 1/2" x 1/2" x 600 mm ■ recommended: system with hose box see chapter "universal products" 	A				
					308,-				

EMPIRE ROYAL CRYSTAL

Maßzeichnungen unter www.joerger.de - Menü SERVICE.
 Technical specifications under www.joerger.de - menu SERVICE.

A chrom chrome	[.000]	E platin matt platinum matt	[.066]
B silbernickel polished nickel	[.035]	F nerz matt mink matt	[.096]
C nerz mink	[.095]	G schwarz-matt black matt	[.092]
C nickel matt satin nickel	[.036]	G weiß-matt white matt	[.052]
D edelmessing sunshine	[.040]	H bronze bronze	[.011]
D platin platinum	[.065]	I gold gold	[.020]
E edelmess.matt sunshine matt	[.041]	L roségold rosegold	[.022]
E gold matt gold matt	[.021]	L roségold matt rosegold matt	[.023]

- 11 kristall klar | crystal clear
- 12 schwarz | black
- 61 kristall matt | crystal matt
- 62 schwarz matt | black matt

Die Artikelnummer wird um weitere 2 Ziffern erweitert. Beispiel:
 Waschtisch 3-Loch Batterie in chrom mit Griffen in kristall klar:

627.30.300.000-11
 Modell Oberfläche Kristallgriff

The article number needs to be added by 2 additional figures. For example:
 washbasin 3-hole mixer in chrome with handles in crystal clear:

627.30.300.000-11
 model surface crystal handle



626.40.150 4-Loch Wannenrandkombination ½"

- für Ab- und Überlaufgarnitur mit Wanneneinlauf, ohne Rohrunterbrecher
- Seitenrandventile, 2-Wege Umstellung
- Metall-Brauseschlauch 2000 mm
- Metall-Handbrause mit Anti-Kalk-System und Rückflussverhinderer

tub/shower combination ½"

- for waste and overflow set with bath tub filler spout, without pipe interrupter
- side valves, 2-position diverter
- metal shower hose 2000 mm
- metal hand shower with anticalc. system and backflow preventer

A	B	C	D	E
1.229,-	1.514,-	1.779,-	1.979,-	2.244,-
F	G	H	I	L
2.189,-	1.789,-	2.459,-	2.828,-	3.276,-

Empfohlen | Recommended

649.40.160 Montageplatte, komplett

- für 4-Loch Armaturen
- Druckschläuche ½" x ½" x 600 mm
- empfohlen: Schlauchkastensystem siehe Kapitel "Serienübergreifendes"

Assembly plate, complete

- for deck mounted tub/shower mixer
- pressure hoses ½" x ½" x 600 mm
- recommended: system with hose box see chapter "universal products"

A	B	C	D	E
308,-				



626.11.100 Wand-Wanneneinlauf ¾"

- Ausladung 200 - 212 mm
- Steckanschluß-Montage

Tub wall spout ¾"

- spout projection 200 - 212 mm
- special concealed wall attachment

A	B	C	D	E
446,-	546,-	596,-	686,-	758,-
F	G	H	I	L
728,-	798,-	776,-	888,-	1.069,-



626.10.820 Wannen 1-Hand Batterie

- für freistehende Montage
- Ausladung 215 mm
- Umstellung Wanne/Brause
- Metall- Handbrause mit Anti-Kalk-System und Rückflußverhinderer
- Metall- Brauseschlauch 1500 mm
- Standrohr mit Befestigungsflansch
- Kartusche mit keramischen Scheiben
- Höhe gesamt 970 - 1055 mm
- Höhe bis Auslauf 885 - 965 mm

Tub/shower mixer set

- free standing assembly
- spout projection 215 mm
- diverter spout/hand shower
- metal hand shower with anticalc. system and backflow preventer
- metal shower hose 1500 mm
- Pillar tube with flange
- ceramic internal upper part
- height 970 - 1055 mm
- outlet height 885 - 965 mm

A	B	C	D	E
2.562,-	2.939,-	3.287,-	3.684,-	4.514,-
F	G	H	I	L
4.059,-	3.107,-	4.287,-	5.164,-	5.754,-

Benötigt | Required

649.10.970 Bausatz-Vormontage

- Bodenplatte mit Befestigungsset
- zu Fertigmontageset 626.10.820

Assembly set for pre-installation

- joint plate with fixing set
- for assembly set 626.10.820

A	B	C	D	E
549,-				

EMPIRE ROYAL CRYSTAL

Maßzeichnungen unter www.joerger.de - Menü SERVICE.
 Technical specifications under www.joerger.de - menu SERVICE.

A chrom chrome	[.000]	E platin matt platinum matt	[.066]
B silbernickel polished nickel	[.035]	F nerz matt mink matt	[.096]
C nerz mink	[.095]	G schwarz-matt black matt	[.092]
C nickel matt satin nickel	[.036]	G weiß-matt white matt	[.052]
D edelmessing sunshine	[.040]	H bronze bronze	[.011]
D platin platinum	[.065]	I gold gold	[.020]
E edelmess.matt sunshine matt	[.041]	L roségold rosegold	[.022]
E gold matt gold matt	[.021]	L roségold matt rosegold matt	[.023]

- 11 kristall klar | crystal clear
- 12 schwarz | black
- 61 kristall matt | crystal matt
- 62 schwarz matt | black matt

Die Artikelnummer wird um weitere 2 Ziffern erweitert. Beispiel:
 Waschtisch 3-Loch Batterie in chrom mit Griffen in kristall klar:

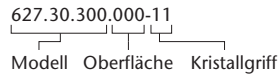

The article number needs to be added by 2 additional figures. For example:
 washbasin 3-hole mixer in chrome with handles in crystal clear:

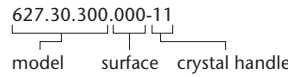

Unterputz-Hebelmischer 1/2" | Concealed single lever mixer 1/2"



626.20.125 1-Hand Wannenfüll- und Brausebatterie 1/2" für UP-Montage, Fertigmontageset

- manuelle, keramische Umstellung für druckunabhängige Funktion
- **mit** Sicherheitseinrichtung
- Durchflussrate 21 l/min bei 3 bar

Concealed single lever wall tub and shower mixer 1/2", assembly set

- manual, ceramic diverter tub/shower for pressure-independent function
- **with** safety device
- flow rate 21 l/min at 3 bar

A	B	C	D	E
858,-	1.078,-	1.249,-	1.295,-	1.574,-
F	G	H	I	L
1.469,-	1.142,-	1.416,-	1.699,-	1.948,-

Variante | Alternative



626.20.135 1-Hand Wannenfüll- und Brausebatterie 1/2" für UP-Montage, Fertigmontageset

- manuelle, keramische Umstellung für druckunabhängige Funktion
- **ohne** Sicherheitseinrichtung
- Durchflussrate 21 l/min bei 3 bar

Concealed single lever wall tub and shower mixer 1/2", assembly set

- manual, ceramic diverter tub/shower for pressure-independent function
- **without** safety device
- flow rate 21 l/min at 3 bar

A	B	C	D	E
838,-	1.058,-	1.229,-	1.275,-	1.554,-
F	G	H	I	L
1.449,-	1.122,-	1.396,-	1.679,-	1.928,-

Variante | Alternative



626.20.235 1-Hand Brausebatterie 1/2" für UP-Montage, Fertigmontageset

- **ohne** Umstellung
- Funktionseinheit mit ker. Scheiben
- Durchflussrate 20,4 l/min bei 3 bar

Concealed single lever shower mixer 1/2", assembly set

- **without** diverter
- functional unit with ceramic discs
- flow rate 20,4 l/min at 3 bar

A	B	C	D	E
669,-	817,-	983,-	1.084,-	1.356,-
F	G	H	I	L
1.239,-	872,-	1.169,-	1.438,-	1.799,-

Benötigt | Required



649.40.360 Unterputz-Einbaubox 1/2"

- zu Fertigmontageset 626.20.125, 626.20.135 und 626.20.235
- für Nass- und Trockenbau geeignet

Concealed wall box 1/2"

- for assembly set 626.20.125, 626.20.135 and 626.20.235
- for wetwall and drywall construction

A	B	C	D	E
168,-				

Unterputz-Thermostate 1/2" | Wall thermostats, concealed 1/2"



626.40.380 Unterputz-Thermostat 1/2" mit Mengenregulierung, Fertigmontageset

- manuelle, keramische Umstellung Wanne/Brause, druckunabhängig
- mit Sicherheitseinrichtung
- Durchflussrate 20,4 l/min bei 3 bar

Concealed wall thermostat 1/2" with flow control, assembly set

- manual, ceramic diverter tub/shower for pressure-independent function
- with safety device
- flow rate 20,4 l/min at 3 bar

A	B	C	D	E
1.179,-	1.342,-	1.436,-	1.545,-	1.829,-
F	G	H	I	L
1.718,-	1.466,-	1.638,-	1.949,-	2.508,-

Benötigt | Required



649.40.360 Unterputz-Einbaubox 1/2"

- zu Fertigmontageset 626.40.380
- für Nass- und Trockenbau geeignet

Concealed wall box 1/2"

- for assembly set 626.40.380
- for wetwall and drywall construction

A	B	C	D	E
168,-				

EMPIRE ROYAL CRYSTAL

Maßzeichnungen unter www.joerger.de - Menü SERVICE.
 Technical specifications under www.joerger.de - menu SERVICE.

A chrom chrome	[.000]	E platin matt platinum matt	[.066]
B silbernickel polished nickel	[.035]	F nerz matt milk matt	[.096]
C nerz milk	[.095]	G schwarz-matt black matt	[.092]
C nickel matt satin nickel	[.036]	G weiß-matt white matt	[.052]
D edelmessing sunshine	[.040]	H bronze bronze	[.011]
D platin platinum	[.065]	I gold gold	[.020]
E edelmess.matt sunshine matt	[.041]	L roségold rosegold	[.022]
E gold matt gold matt	[.021]	L roségold matt rosegold matt	[.023]

- 11 kristall klar | crystal clear
- 12 schwarz | black
- 61 kristall matt | crystal matt
- 62 schwarz matt | black matt

Die Artikelnummer wird um weitere 2 Ziffern erweitert. Beispiel:
 Waschtisch 3-Loch Batterie in chrom mit Griffen in kristall klar:

627.30.300.000-11
 Modell Oberfläche Kristallgriff

The article number needs to be added by 2 additional figures. For example:
 washbasin 3-hole mixer in chrome with handles in crystal clear:

627.30.300.000-11
 model surface crystal handle

Variante | Alternative



626.40.360 Unterputz-Thermostat 1/2" mit Mengenregulierung, Fertigmontageset
 ■ ohne Umstellung
 ■ mit integrierter keramischer Mengenregulierung
 ■ Durchflussrate 20,4 l/min bei 3 bar

Concealed wall thermostat 1/2" with flow control, assembly set
 ■ without diverter
 ■ with integrated ceramic cartridge for volume control
 ■ flow rate 20,4 l/min at 3 bar

A	B	C	D	E
1.145,-	1.308,-	1.399,-	1.510,-	1.794,-
F	G	H	I	L
1.664,-	1.432,-	1.599,-	1.915,-	2.474,-

Variante | Alternative



626.40.460 Unterputz-Thermostat 1/2" ohne Mengenregulierung, Fertigmontageset
 ■ Funktionseinheit ohne Umstellung und ohne Absperrung
 ■ Durchflussrate 25,8 l/min bei 3 bar

Concealed wall thermostat 1/2" without flow control, assembly set
 ■ Functional unit without diverter and without shut-off
 ■ flow rate 25,8 l/min at 3 bar

A	B	C	D	E
929,-	1.078,-	1.184,-	1.316,-	1.577,-
F	G	H	I	L
1.469,-	1.280,-	1.428,-	1.691,-	2.244,-

Benötigt | Required



649.40.360 Unterputz-Einbaubox 1/2"
 ■ zu Fertigmontageset 626.40.360 und 626.40.460
 ■ für Nass- und Trockenbau geeignet

Concealed wall box 1/2"
 ■ for assembly set 626.40.360 and 626.40.460
 ■ for wetwall and drywall construction

A	B	C	D	E
168,-				

Unterputz-Thermostat 3/4" mit hohem Durchfluß | Wall thermostat, concealed 3/4" with high flow



626.40.555 Unterputz-Thermostat 3/4" ohne Mengenregulierung, Fertigmontageset
 ■ serienbezogener Temperiergriff
 ■ Sicherheitssperre bei 38° C

Concealed wall thermostat 3/4" without flow control, assembly set
 ■ design handle for temp. control
 ■ locking device at 38°C

A	B	C	D	E
577,-	648,-	736,-	779,-	942,-
F	G	H	I	L
846,-	782,-	949,-	1.262,-	1.676,-

Benötigt | Required



649.40.555 Unterputz-Einbaukörper 3/4"
 ■ zu Fertigmontageset 626.40.555
 ■ Kartusche mit Schmutzfangsieben
 ■ für Nass- und Trockenbau geeignet
 ■ Durchflussrate 64,2 l/min bei 3 bar
 ■ ohne Absperrung

Concealed thermostat body 3/4"
 ■ for assembly set 626.40.555
 ■ cartridge with filter screens
 ■ for wetwall and drywall construction
 ■ flow rate 64,2 l/min at 3 bar
 ■ without shut-off

A	B	C	D	E
1.636,-				

Unterputz-Thermostat 3/4" | Wall thermostat, concealed 3/4"



626.40.520 Unterputz-Thermostat 3/4" ohne Mengenregulierung, Fertigmontageset
 ■ serienbezogener Temperiergriff
 ■ Sicherheitssperre bei 38° C

Concealed wall thermostat 3/4" without flow control, assembly set
 ■ design handle for temp. control
 ■ locking device at 38°C

A	B	C	D	E
659,-	736,-	829,-	874,-	1.045,-
F	G	H	I	L
946,-	877,-	1.049,-	1.368,-	1.799,-

Benötigt | Required



649.40.520 Unterputz-Einbaukörper 3/4"
 ■ zu Fertigmontageset 626.40.520
 ■ Kartusche mit Schmutzfangsieben
 ■ für Nass- und Trockenbau geeignet
 ■ Durchflussrate 41 l/min bei 3 bar
 ■ ohne Absperrung

Concealed thermostat body 3/4"
 ■ for assembly set 626.40.520
 ■ cartridge with filter screens
 ■ for wetwall and drywall construction
 ■ flow rate 41 l/min at 3 bar
 ■ without shut-off

A	B	C	D	E
498,-				

EMPIRE ROYAL CRYSTAL

Maßzeichnungen unter www.joerger.de - Menü SERVICE.
 Technical specifications under www.joerger.de - menu SERVICE.

A chrom chrome	[.000]	E platin matt platinum matt	[.066]
B silbernickel polished nickel	[.035]	F nerz matt milk matt	[.096]
C nerz milk	[.095]	G schwarz-matt black matt	[.092]
C nickel matt satin nickel	[.036]	G weiß-matt white matt	[.052]
D edelmessing sunshine	[.040]	H bronze bronze	[.011]
D platin platinum	[.065]	I gold gold	[.020]
E edelmess.matt sunshine matt	[.041]	L roségold rosegold	[.022]
E gold matt gold matt	[.021]	L roségold matt rosegold matt	[.023]

- 11 kristall klar | crystal clear
- 12 schwarz | black
- 61 kristall matt | crystal matt
- 62 schwarz matt | black matt

Die Artikelnummer wird um weitere 2 Ziffern erweitert. Beispiel:
 Waschtisch 3-Loch Batterie in chrom mit Griffen in kristall klar:

627.30.300.000-11
 Modell Oberfläche Kristallgriff

The article number needs to be added by 2 additional figures. For example:
 washbasin 3-hole mixer in chrome with handles in crystal clear:

627.30.300.000-11
 model surface crystal handle

Unterputz-Thermostat/Ventil-Modul | Concealed thermostatic/wall-valve modul



626.60.432 Unterputz-Ventil-Modul
 Fertigmontageset
 ■ Griff
 ■ Rosette

Concealed wall-valve-modul
 assembly set
 ■ design handle
 ■ escutcheon

A	B	C	D	E
308,-	395,-	438,-	489,-	574,-
F	G	H	I	L
532,-	384,-	474,-	679,-	774,-

Benötigt | Required



649.20.610 Unterputz-Ventil-Modul, 1-fach
 ■ 1x Spindelventil 3/4", rechtsschließend mit keram. Scheiben
 ■ 2 Abgänge 1/2", je 1x rechts/links möglich, gleichzeitig benutzbar

Concealed wall-valve-modul, single
 ■ 1x spindle valve 3/4", clockwise closure with ceramic discs
 ■ 2 outlets 1/2", each 1x right/left possible, simultaneously usable

A	B	C	D	E
229,-				



649.20.620 Unterputz-Ventil-Modul, 2-fach
 ■ 2x Spindelventil 3/4", rechtsschließend mit keram. Scheiben
 ■ 4 Abgänge 1/2", je 2x rechts/links möglich, gleichzeitig benutzbar
 ■ im Verbund maßgenaue Montage
 ■ erweiterbar mit 649.20.610

Concealed wall-valve-modul, double
 ■ 2x spindle valve 3/4", clockwise closure with ceramic discs
 ■ 4 outlets 1/2", each 2x right/left possible, simultaneously usable
 ■ precise assembly due to composite
 ■ expandable with 649.20.610

A	B	C	D	E
458,-				



649.20.630 Unterputz-Ventil-Modul, 3-fach
 ■ 3x Spindelventil 3/4", rechtsschließend mit keram. Scheiben
 ■ 6 Abgänge 1/2", je 3x rechts/links möglich, gleichzeitig benutzbar
 ■ im Verbund maßgenauen Montage
 ■ erweiterbar mit 649.20.610

Concealed wall-valve-modul, triple
 ■ 3x spindle valve 3/4", clockwise closure with ceramic discs
 ■ 6 outlets 1/2", each 3x right/left possible, simultaneously usable
 ■ precise assembly due to composite
 ■ expandable with 649.20.610

A	B	C	D	E
686,-				



626.40.555 Unterputz-Thermostat 3/4"
ohne Mengenregulierung,
 Fertigmontageset
 ■ serienbezogener Temperiergriff
 ■ Sicherheitssperre bei 38° C

Concealed wall thermostat 3/4"
without flow control,
 assembly set
 ■ design handle for temp. control
 ■ locking device at 38° C

A	B	C	D	E
577,-	648,-	736,-	779,-	942,-
F	G	H	I	L
846,-	782,-	949,-	1.262,-	1.676,-

Benötigt | Required

649.20.634 Anschlußadapter 3/4"
 ■ Anschlußadapter, Abschlußstopfen
 ■ passend zu Einbaukörper 649.40.555

Connection adapter 3/4"
 ■ connection adapter, end plug
 ■ matching to wall body 649.40.555

A	B	C	D	E
146,-				



649.40.555 Unterputz-Einbaukörper 3/4"
 ■ zu Fertigmontageset 626.40.555
 ■ Kartusche mit Schmutzfängsieben
 ■ für Nass- und Trockenbau geeignet
 ■ Durchflussrate 64,2 l/min bei 3 bar
 ■ ohne Absperrung

Concealed thermostat body 3/4"
 ■ for assembly set 626.40.555
 ■ cartridge with filter screens
 ■ for wetwall and drywall construction
 ■ flow rate 64,2 l/min at 3 bar
 ■ without shut-off

A	B	C	D	E
1.636,-				

EMPIRE ROYAL CRYSTAL

Maßzeichnungen unter www.joerger.de - Menü SERVICE.
 Technical specifications under www.joerger.de - menu SERVICE.

A chrom chrome	[.000]	E platin matt platinum matt	[.066]
B silbernickel polished nickel	[.035]	F nerz matt milk matt	[.096]
C nerz milk	[.095]	G schwarz-matt black matt	[.092]
C nickel matt satin nickel	[.036]	G weiß-matt white matt	[.052]
D edelmessing sunshine	[.040]	H bronze bronze	[.011]
D platin platinum	[.065]	I gold gold	[.020]
E edelmess.matt sunshine matt	[.041]	L roségold rosegold	[.022]
E gold matt gold matt	[.021]	L roségold matt rosegold matt	[.023]

- 11 kristall klar | crystal clear
- 12 schwarz | black
- 61 kristall matt | crystal matt
- 62 schwarz matt | black matt

Die Artikelnummer wird um weitere 2 Ziffern erweitert. Beispiel:
 Waschtisch 3-Loch Batterie in chrom mit Griffen in kristall klar:

627.30.300.000-11
 Modell Oberfläche Kristallgriff

The article number needs to be added by 2 additional figures. For example:
 washbasin 3-hole mixer in chrome with handles in crystal clear:

627.30.300.000-11
 model surface crystal handle



626.40.460 Unterputz-Thermostat 1/2" **ohne** Mengenregulierung, Fertigmontageset
 ■ Funktionseinheit **ohne** Umstellung und **ohne** Absperrung
 ■ Durchflussrate 25,8 l/min bei 3 bar

Concealed wall thermostat 1/2" **without** flow control, assembly set
 ■ Functional unit **without** diverter and **without** shut-off
 ■ flow rate 25,8 l/min at 3 bar

A	B	C	D	E
929,-	1.078,-	1.184,-	1.316,-	1.577,-
F	G	H	I	L
1.469,-	1.280,-	1.428,-	1.691,-	2.244,-

Benötigt | Required

649.20.612 Anschlußadapter 1/2"
 ■ Anschlußadapter, Abschlußstopfen
 ■ passend zu Einbaubox 649.40.360



Connection adapter 1/2"
 ■ connection adapter, end plug
 ■ matching to wall box 649.40.360

A	B	C	D	E
122,-				

649.40.360 Unterputz-Einbaubox 1/2"
 ■ zu Fertigmontageset 626.40.460
 ■ für Nass- und Trockenbau geeignet



Concealed wall box 1/2"
 ■ for assembly set 626.40.460
 ■ for wetwall and drywall construction

A	B	C	D	E
168,-				



626.50.234 Unterputz-Ventil Fertigmontageset
 ■ Griff
 ■ Hülse, Schubrosette

Concealed wall valve assembly set
 ■ design handle
 ■ socket with adjustable escutcheon

A	B	C	D	E
336,-	432,-	479,-	536,-	628,-
F	G	H	I	L
582,-	418,-	452,-	745,-	849,-

Benötigt | Required

649.20.351 Unterputz-Ventil 1/2", Einbaukörper
 ■ rechtsschließend, ker. Scheiben



Concealed wall valve 1/2", body
 ■ clockwise closure, ceramic discs

A	B	C	D	E
74,-				

649.20.356 Unterputz-Ventil 1/2", Einbaukörper
 ■ linksschließend, ker. Scheiben



Concealed wall valve 1/2", body
 ■ counter-clockwise closure, cer. discs

A	B	C	D	E

649.20.451 Unterputz-Ventil 3/4", Einbaukörper
 ■ rechtsschließend, ker. Scheiben



Concealed wall valve 3/4", body
 ■ clockwise closure, ceramic discs

A	B	C	D	E
102,-				

649.20.456 Unterputz-Ventil 3/4", Einbaukörper
 ■ linksschließend, ker. Scheiben



Concealed wall valve 3/4", body
 ■ counter-clockwise closure, cer. discs

A	B	C	D	E

Unterputz-Umstellung und Ventile | Diverter and valves concealed



626.40.650 Unterputz 3-Wege Umstellung 1/2" Fertigmontageset
 ■ Griff
 ■ Hülse, Schubrosette

Concealed 3-position diverter 1/2" assembly set
 ■ design handle
 ■ socket with adjustable escutcheon

A	B	C	D	E
352,-	452,-	499,-	559,-	656,-
F	G	H	I	L
608,-	358,-	452,-	778,-	888,-

Benötigt | Required

649.40.600 Unterputz 3-Wege Umstellung 1/2" Einbaukörper
 ■ zu Fertigmontageset 626.40.650



Concealed 3-position diverter 1/2" diverter body
 ■ for assembly set 626.40.650









A	B	C	D	E
236,-				

EMPIRE ROYAL CRYSTAL

Maßzeichnungen unter www.joerger.de - Menü SERVICE.
 Technical specifications under www.joerger.de - menu SERVICE.

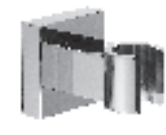
A chrom chrome	[.000]	E platin matt platinum matt	[.066]
B silbernickel polished nickel	[.035]	F nerz matt milk matt	[.096]
C nerz milk	[.095]	G schwarz-matt black matt	[.092]
C nickel matt satin nickel	[.036]	G weiß-matt white matt	[.052]
D edelmessing sunshine	[.040]	H bronze bronze	[.011]
D platin platinum	[.065]	I gold gold	[.020]
E edelmess.matt sunshine matt	[.041]	L roségold rosegold	[.022]
E gold matt gold matt	[.021]	L roségold matt rosegold matt	[.023]

Bräusen | Showers

		A	B	C	D	E	
	626.13.300 Duschgarnitur, komplett <ul style="list-style-type: none"> Wandrohr 760 mm, mit Schieber Metall-Handbrause mit Anti-Kalk-System und Rückflussverhinderer Metall-Brauseschlauch 1750 mm, beidseitig mit drehbarem Konus 	Shower bar set, complete <ul style="list-style-type: none"> wall bar 760 mm, with slider metal hand shower with anticalc. system and backflow preventer metal shower hose 1750 mm, both sides with turning cone 	494,-	692,-	885,-	989,-	1.296,-
			F	G	H	I	L
			1.149,-	1.098,-	1.689,-	1.742,-	3.014,-
	626.13.350 Duschstange, lose <ul style="list-style-type: none"> Wandrohr 760 mm, mit Schieber 	Shower bar, separate <ul style="list-style-type: none"> wall bar 760 mm, with slider 	326,-	485,-	576,-	679,-	869,-
			F	G	H	I	L
			796,-	628,-	929,-	1.138,-	1.866,-
	626.13.210 Schlauchbrausegarnitur <ul style="list-style-type: none"> Wandanschlußbogen 1/2", Schubrosette Wand-Brausehalter Metall-Handbrause mit Anti-Kalk-System und Rückflussverhinderer Metall-Brauseschlauch 1500 mm, beidseitig mit drehbarem Konus 	Shower combination <ul style="list-style-type: none"> wall elbow connection 1/2", escutcheon wall fitting for hand shower metal hand shower with anticalc. system and backflow preventer metal shower hose 1500 mm, both sides with turning cone 	348,-	495,-	583,-	688,-	994,-
			F	G	H	I	L
			828,-	756,-	1.096,-	1.262,-	1.919,-
	626.13.155 Wandanschlußbogen 1/2", ohne Haken <ul style="list-style-type: none"> Brauseabgang 1/2" mit Rückflussverhinderer, Rosette 	Wall elbow connection 1/2", without cradle <ul style="list-style-type: none"> discharge 1/2" with backflow preventer, escutcheon 	145,-	162,-	184,-	209,-	249,-
			F	G	H	I	L
			227,-	218,-	238,-	296,-	385,-
	649.13.220 Wand-Brausehalter	Wall fitting for hand shower	179,-	206,-	238,-	262,-	314,-
			F	G	H	I	L
			292,-	212,-	278,-	390,-	479,-
	626.13.237 Hygienebrausegarnitur <ul style="list-style-type: none"> Wandbrausehalter und -anschlußbogen 1/2", Schubrosette Hygienebrause, quadratisch (649.13.334), komplett aus Metall einstrahlig, Bedienung über Druckhebel Metall-Brauseschlauch 1250 mm 	Ablution spray combination <ul style="list-style-type: none"> wall fitting and elbow connection 1/2" spray handshower, square (649.13.334), completely metal one jet, push-lever operation flexible metal shower hose 1250 mm 	409,-	548,-	696,-	748,-	867,-
			F	G	H	I	L
			798,-	795,-	1.118,-	1.212,-	1.649,-
	626.20.237 1-Hand Batterie 1/2" für Hygiene-Brause, Fertigmontageset <ul style="list-style-type: none"> Rosette, Griff 	Concealed single lever 1/2" for ablution spray, assembly set <ul style="list-style-type: none"> escutcheon, handle 	271,-	342,-	439,-	496,-	594,-
			F	G	H	I	L
			567,-	532,-	612,-	690,-	819,-
	Benötigt Required 649.20.237 Unterputz 1-Hand Batterie 1/2", Einbaukörper <ul style="list-style-type: none"> Kartusche mit keramischen Scheiben zu Fertigmontageset 626.20.237 	Single lever mixer 1/2", concealed body <ul style="list-style-type: none"> cartridge with ceramic discs for assembly set 626.20.237 	125,-	169,-	208,-	229,-	268,-
			F	G	H	I	L
			249,-	224,-	258,-	329,-	396,-

EMPIRE ROYAL CRYSTAL

Maßzeichnungen unter www.joerger.de - Menü SERVICE.
 Technical specifications under www.joerger.de - menu SERVICE.

A chrom chrome	[.000]	E platin matt platinum matt	[.066]
B silbernickel polished nickel	[.035]	F nerz matt milk matt	[.096]
C nerz milk	[.095]	G schwarz-matt black matt	[.092]
C nickel matt satin nickel	[.036]	G weiß-matt white matt	[.052]
D edelmessing sunshine	[.040]	H bronze bronze	[.011]
D platin platinum	[.065]	I gold gold	[.020]
E edelmess.matt sunshine matt	[.041]	L roségold rosegold	[.022]
E gold matt gold matt	[.021]	L roségold matt rosegold matt	[.023]



649.13.975 Regenbrause ½“, 300 x 300 mm

- Ausführung ganz in Metall
- 3 mm ultra flach
- mit Kugelgelenk
- Anti-Kalk-System
- ohne Wandarm

- weitere, zur Serie passende Kopfbrausen siehe Kapitel “Brausen”

Rain shower head ½“, 300 x 300 mm

- full metal body
- 3 mm ultra-thin
- with ball joint
- with anticalcareous system
- without wall bracket

- for further shower heads matching this collection see chapter “showers”

A	B	C	D	E
756,-	1.646,-	1.854,-	1.989,-	2.398,-
F	G	H	I	L
2.296,-	1.854,-	2.368,-	2.896,-	3.568,-

Empfohlen | Recommended



649.13.785 Wandarm ½“

- Ausladung 350 mm

- weitere, zur Serie passende Wandarme siehe Kapitel “Brausen”

Wall bracket ½“

- projection 350 mm

- for further wall brackets matching this collection see chapter “showers”

A	B	C	D	E
198,-	264,-	318,-	346,-	456,-
F	G	H	I	L
399,-	334,-	436,-	518,-	740,-



649.13.771 Deckenanbindung ½“

- Länge 150 mm

- weitere, zur Serie passende Deckenanbindungen siehe Kapitel “Brausen”

Ceiling bracket ½“

- length 150 mm

- for further ceiling brackets matching this collection see chapter “showers”

A	B	C	D	E
176,-	292,-	350,-	395,-	462,-
F	G	H	I	L
446,-	350,-	442,-	558,-	836,-



649.13.526 Seitenbrause ½“

- Rosette 125 x 125 mm, Wandmontage
- Brausekopf schwenkbar, 20°
- Anti-Kalk-System
- Ausführung Kunststoff

- weitere, zur Serie passende Seitenbrausen siehe Kapitel “Brausen”

Body spray side shower ½“

- escutcheon 125 x 125 mm, wall assembly
- swivel shower head, 20°
- anticalcareous system
- plastic

- for further side showers matching this collection see chapter “showers”

A	B	C	D	E
186,-	329,-	384,-	406,-	542,-
F	G	H	I	L
508,-	392,-	472,-	659,-	944,-



649.13.375 Handbrause ½“

- Ausführung Metall
- Anti-Kalk-System
- Anschluß ½“

- weitere, zur Serie passende Handbrausen siehe Kapitel “Brausen”

Hand shower ½“

- brass
- anticalcareous system
- connection ½“

- for further hand showers matching this collection see chapter “showers”







A	B	C	D	E
168,-	212,-	288,-	324,-	379,-
F	G	H	I	L
352,-	314,-	392,-	439,-	629,-

EMPIRE ROYAL CRYSTAL

Maßzeichnungen unter www.joerger.de - Menü SERVICE.
 Technical specifications under www.joerger.de - menu SERVICE.

A chrom chrome	[.000]	E platin matt platinum matt	[.066]
B silbernickel polished nickel	[.035]	F nerz matt mink matt	[.096]
C nerz mink	[.095]	G schwarz-matt black matt	[.092]
C nickel matt satin nickel	[.036]	G weiß-matt white matt	[.052]
D edelmessing sunshine	[.040]	H bronze bronze	[.011]
D platin platinum	[.065]	I gold gold	[.020]
E edelmess.matt sunshine matt	[.041]	L roségold rosegold	[.022]
E gold matt gold matt	[.021]	L roségold matt rosegold matt	[.023]

Accessoires für Handtücher | Accessories for towels

		A	B	C	D	E
	626.00.002 Handtuchhalter ■ Rohr starr, ca. 415 mm	Towel bar ■ rigid bar, approx. 415 mm		A	B	E
		125,-	182,-	236,-	266,-	312,-
		F	G	H	I	L
		289,-	236,-	290,-	376,-	678,-
	627.00.047 Handtuchring ■ 220 x 105 mm ■ geschlossene Ausführung	Towel ring ■ 220 x 105 mm ■ closed version		A	B	E
		138,-	199,-	259,-	292,-	342,-
		F	G	H	I	L
		318,-	285,-	319,-	414,-	746,-
	626.00.022 Handtuchhaken	Robe hanger		A	B	E
		59,-	84,-	89,-	96,-	116,-
		F	G	H	I	L
		108,-	98,-	112,-	156,-	268,-
	626.00.040 Badetuchhalter ■ ca. 770 mm	Bath towel bar ■ approx. 770 mm		A	B	E
		189,-	324,-	459,-	519,-	772,-
		F	G	H	I	L
		666,-	335,-	616,-	986,-	1.432,-
	626.00.031 Wannengriff ■ ca. 305 mm	Tub handle ■ approx. 305 mm		A	B	E
		124,-	192,-	264,-	298,-	436,-
		F	G	H	I	L
		378,-	278,-	416,-	556,-	872,-
	626.00.030 Duschtürgriff ■ ca. 560 mm	Shower door handle ■ approx. 560 mm		A	B	E
		316,-	475,-	599,-	669,-	929,-
		F	G	H	I	L
		819,-	639,-	889,-	1.199,-	1.929,-
	634.00.104 Gästehandtuchkorb, eckig ■ mit Ablage ■ Korbgröße 260 x 150 x 190 mm	Guest towel basket, angular ■ with shelf ■ basket size 260 x 150 x 190 mm		A	B	E
		230,-	314,-	356,-	389,-	528,-
		F	G	H	I	L
		466,-	492,-	675,-	849,-	1.499,-

EMPIRE ROYAL CRYSTAL

Maßzeichnungen unter www.joerger.de - Menü SERVICE.
 Technical specifications under www.joerger.de - menu SERVICE.

A chrom chrome	[.000]	E platin matt platinum matt	[.066]
B silbernickel polished nickel	[.035]	F nerz matt mink matt	[.096]
C nerz mink	[.095]	G schwarz-matt black matt	[.092]
C nickel matt satin nickel	[.036]	G weiß-matt white matt	[.052]
D edelmessing sunshine	[.040]	H bronze bronze	[.011]
D platin platinum	[.065]	I gold gold	[.020]
E edelmess.matt sunshine matt	[.041]	L roségold rosegold	[.022]
E gold matt gold matt	[.021]	L roségold matt rosegold matt	[.023]

Accessoires für Waschplatz | Accessories for washstands

	627.00.007 Seifenhalter, komplett ■ Seifenschale aus Kristallglas ■ Ausrichtung nach rechts ■ Auf Wunsch ist die Ausrichtung auch nach links möglich	Soap dish holder, complete ■ crystal glass dish ■ right side alignment ■ on request, the alignment is also possible to the left	A	B	C	D	E
			114,-	189,-	225,-	242,-	324,-
			F	G	H	I	L
			285,-	176,-	238,-	356,-	479,-

727.00.307 Seifenschale, lose	Glass dish, separate	A				
		34,-				

	627.00.017 Seifenhalter, komplett ■ Standmodell ■ Seifenschale aus Kristallglas, seidenmatt	Soap dish holder, complete ■ free standing version ■ crystal glass dish, frosted	A	B	C	D	E
			94,-	117,-	129,-	144,-	184,-
			F	G	H	I	L
			164,-	172,-	234,-	282,-	366,-

	627.00.006 Lotionspender, komplett ■ Wandmodell ■ Ausführung Metall	Soap dispenser, complete ■ wall version ■ brass	A	B	C	D	E
			319,-	395,-	459,-	495,-	664,-
			F	G	H	I	L
			594,-	499,-	658,-	738,-	1.179,-

	626.00.016 Lotionspender, komplett ■ Standmodell ■ Ausführung Metall	Soap dispenser, complete ■ free standing version ■ brass	A	B	C	D	E
			289,-	354,-	426,-	459,-	612,-
			F	G	H	I	L
			548,-	464,-	606,-	679,-	1.082,-

	634.00.105 Schwammkorb ■ rechteckig, 260 x 130 mm	Sponge basket ■ rectangular, 260 x 130 mm	A	B	C	D	E
			199,-	238,-	279,-	332,-	462,-
			F	G	H	I	L
			396,-	348,-	459,-	589,-	859,-

	634.00.106 Eckschwammkorb ■ 195 x 195 mm	Corner sponge basket ■ 195 x 195 mm	A	B	C	D	E
			195,-	234,-	275,-	328,-	458,-
			F	G	H	I	L
			390,-	344,-	455,-	585,-	855,-

EMPIRE ROYAL CRYSTAL

Maßzeichnungen unter www.joerger.de - Menü SERVICE.
 Technical specifications under www.joerger.de - menu SERVICE.

A chrom chrome	[.000]	E platin matt platinum matt	[.066]
B silbernickel polished nickel	[.035]	F nerz matt mink matt	[.096]
C nerz mink	[.095]	G schwarz-matt black matt	[.092]
C nickel matt satin nickel	[.036]	G weiß-matt white matt	[.052]
D edelmessing sunshine	[.040]	H bronze bronze	[.011]
D platin platinum	[.065]	I gold gold	[.020]
E edelmess.matt sunshine matt	[.041]	L roségold rosegold	[.022]
E gold matt gold matt	[.021]	L roségold matt rosegold matt	[.023]

	627.00.036 Glashalter, komplett ■ Glas aus Kristallglas, seidenmatt ■ Ausrichtung nach links ■ Auf Wunsch ist die Ausrichtung auch nach rechts möglich	Tumbler holder, complete ■ crystal glass tumbler, frosted ■ left side alignment ■ on request, the alignment is also possible to the right	A	B	C	D	E	
			116,-	192,-	228,-	245,-	326,-	
			F	G	H	I	L	
				288,-	179,-	240,-	359,-	482,-

727.00.336 Mundglas, seidenmatt, lose	Glass tumbler, frosted, separate	A				
		54,-				

	627.00.046 Glashalter, komplett ■ Standmodell ■ Glas aus Kristallglas, seidenmatt	Tumbler holder, complete ■ free standing version ■ crystal glass tumbler, frosted	A	B	C	D	E	
			96,-	115,-	127,-	142,-	182,-	
			F	G	H	I	L	
				162,-	174,-	236,-	284,-	364,-

Accessoires für WC-Bürsten | Accessories for toilet area

	626.00.014 Papierhalter ■ beweglicher Bügel	Toilet paper roll holder ■ mobile bracket	A	B	C	D	E	
			179,-	214,-	264,-	289,-	398,-	
			F	G	H	I	L	
				352,-	319,-	519,-	756,-	986,-

	626.00.015 Reserve-Papierhalter	Spare toilet paper roll holder	A	B	C	D	E	
			116,-	159,-	205,-	225,-	310,-	
			F	G	H	I	L	
				275,-	188,-	299,-	349,-	544,-

	627.00.000 Klosettbürstengarnitur, komplett ■ wandhängendes Modell ■ Bürstentopf aus Metall	Toilet brush holder set, complete ■ suspended model ■ brush holder out of brass	A	B	C	D	E	
			238,-	327,-	399,-	435,-	592,-	
			F	G	H	I	L	
				526,-	509,-	749,-	964,-	1.352,-

677.00.053 Bürstenstange, komplett, lose	Brush rod with brush, separate	A	B	C	D	E		
		84,-	114,-	139,-	152,-	208,-		
		F	G	H	I	L		
				184,-	178,-	262,-	332,-	472,-

799.00.236 Bürstenkopf, lose	Brush, separate	A				
		22,-				

EMPIRE ROYAL CRYSTAL

Maßzeichnungen unter www.joerger.de - Menü SERVICE.
 Technical specifications under www.joerger.de - menu SERVICE.

A chrom chrome	[.000]	E platin matt platinum matt	[.066]
B silbernickel polished nickel	[.035]	F nerz matt mink matt	[.096]
C nerz mink	[.095]	G schwarz-matt black matt	[.092]
C nickel matt satin nickel	[.036]	G weiß-matt white matt	[.052]
D edelmessing sunshine	[.040]	H bronze bronze	[.011]
D platin platinum	[.065]	I gold gold	[.020]
E edelmess.matt sunshine matt	[.041]	L roségold rosegold	[.022]
E gold matt gold matt	[.021]	L roségold matt rosegold matt	[.023]



627.00.001 Klosettbürstengarnitur, komplett
 ■ stehendes Modell
 ■ Bürstentopf aus Metall

Toilet brush holder set, complete
 ■ floor standing model
 ■ brush holder out of brass

A	B	C	D	E
198,-	286,-	359,-	395,-	552,-
F	G	H	I	L
486,-	469,-	709,-	924,-	1.312,-

Spiegel | Mirrors



649.00.418 Kosmetikspiegel, beleuchtet
 ■ schwenk- und ausziehbar
 ■ 3-fache Vergrößerung
 ■ Direktanschluss
 ■ Spiegeldurchmesser 185 mm
 ■ Rahmendurchmesser 250 mm
 ■ Kalt-, Warm- und Taglicht durch Piezzo-Schalter umschaltbar

Cosmetic mirror, incl. lighting
 ■ swivelling and extendable
 ■ magnification 3:1
 ■ direct connection
 ■ mirror diameter 185 mm
 ■ frame diameter 250 mm
 ■ cold, warm and day light switchable by Piezzo switch

A	B	C	D	E
556,-	988,-	1.214,-	1.418,-	1.828,-
F	G	H	I	L
1.684,-	1.214,-	1.549,-	2.138,-	2.998,-





Oberflächen | colours

Folgende Oberflächen sind bei dieser Serie möglich |
The following colours are possible with this collection

chrom	chrome	[.000]	PG A
silbernickel	polished nickel	[.035]	PG B
nerz	mink	[.095]	PG C
nickel matt	satin nickel	[.036]	PG C
edelmessing	sunshine	[.040]	PG D
platin	platinum	[.065]	PG D
edelmessing matt	sunshine matt	[.041]	PG E
gold matt	gold matt	[.021]	PG E
platin matt	platinum matt	[.066]	PG E
nerz matt	mink matt	[.096]	PG F
schwarz matt	black matt	[.092]	PG G
weiß matt	white matt	[.052]	PG G
bronze	bronze	[.011]	PG H
gold	gold	[.020]	PG I
rosé-gold	rose-gold	[.022]	PG L
rosé-gold matt	rose-gold matt	[.023]	PG L

Andere Oberflächen auf Anfrage |
Different colours on request

Auf Anfrage können wir Produkte von Drittanbietern auch gerne passend zu unseren Oberflächen veredeln (vorbehaltlich der Eignungsprüfung) | Third-party products may be plated matching to our colours on request (subject to valuation of suitability)

Waschtisch | Washbasin

ab Seite | from page 113

Bidet | Bidet

ab Seite | from page 115

Wanne | Bath tub

ab Seite | from page 116

Dusche | Shower

ab Seite | from page 118

Accessoires | Accessories

ab Seite | from page 127

VALENCIA

Die Modellnummer wird mit drei weiteren Ziffern für die Oberfläche erweitert. Die dann entstandene Artikelnummer identifiziert die Version mit den Metalleinsätzen.

Beispiel: Waschtisch 3-Loch Batterie in nerz
mit Metalleinsatz in nerz:

638.30.300.095
 Modell Oberfläche

The model number is extended with three more digits for the finish. The article number then created identifies the version with the metal inserts.

Example: washbasin 3-hole mixer in mink
with metal inlays in mink:

638.30.300.095
 model surface

Die Artikelnummer für die unterschiedlichen Inlays aus Kristall- oder Natursteinen werden um weitere zwei Ziffern erweitert.

Beispiel: Waschtisch 3-Loch Batterie in chrom
mit Kristalleinsatz in schwarz:

638.30.300.000-12
 Modell Oberfläche Kristall- oder Natursteineinsatz

The article number for the different inlays made of crystal or natural stones are extended by two more digits.

Example: washbasin 3-hole mixer in chrome
with crystal inlays in black:

638.30.300.000-12
 model surface crystal or natural stone inlay

MÖGLICHE INLAYS | POSSIBLE INLAYS



(-12) Schwarz
black



(-21) Weiss
white



Metall
metal

Bei den meisten Armaturen besteht die Wahl zwischen unterschiedlichen Griffeneinsätzen. Zur Auswahl stehen Kristallfarben, Natursteine oder auch Einsätze aus Metall passend zu der Oberfläche der Armatur. Die genannten Preise gelten sowohl für die Kristall- als auch die Metall-Varianten.



(-53) Amethyst
Amethyst

Aufpreis | surcharge: 150,-



(-55) Labradorit
Labradorite

Aufpreis | surcharge: 150,-



(-56) Avanturin blau
Avanturine blue

Aufpreis | surcharge: 150,-

Sollten Sie sich für die einzigartigen Einsätze aus Naturstein entscheiden, ist pro Stein jeweils ein Aufpreis wie angegeben zu berücksichtigen.

For most taps there is a choice between different handle inserts. You can choose from crystal colors, natural stones or metal inserts to match the surface of the fitting. The prices quoted apply to both the crystal and the metal versions.



(-51) Weißer Türkis
White turquoise

Aufpreis | surcharge: 150,-



(-52) Schwarzer Marmor
Black Marble

Aufpreis | surcharge: 150,-



(-54) Malachit
Malachite

Aufpreis | surcharge: 300,-

If you opt for the unique inserts made of natural stone, an extra charge per stone must be taken into account as stated.

VALENCIA

Maßzeichnungen unter www.joerger.de - Menü SERVICE.
 Technical specifications under www.joerger.de - menu SERVICE.

A chrom chrome	[.000]	E platin matt platinum matt	[.066]
B silbernickel polished nickel	[.035]	F nerz matt milk matt	[.096]
C nerz milk	[.095]	G schwarz-matt black matt	[.092]
C nickel matt satin nickel	[.036]	G weiß-matt white matt	[.052]
D edelmessing sunshine	[.040]	H bronze bronze	[.011]
D platin platinum	[.065]	I gold gold	[.020]
E edelmess.matt sunshine matt	[.041]	L rosé-gold rose-gold	[.022]
E gold matt gold matt	[.021]	L rosé-gold matt rose-gold matt	[.023]

-12 schwarz | black
 -21 weiß | white

mit Aufpreis / with surcharge

-51 Weißer Türkis | White turquoise
 -52 Schwarzer Marmor | Black Marble
 -53 Amethyst | Amethyst
 -54 Malachit | Malachite
 -55 Labradorit | Labradorite
 -56 blauer Avanturin | blue Aventurine

Waschtisch Batterien | Washbasin mixer



638.30.300

Waschtisch 3-Loch Batterie 1/2"

- Ausladung 150 mm; Höhe 270 mm
- Auslauf schwenkbar
- 2 Seitenrandventile mit keramischen Oberteilen 1/2"
- Ablaufventil mit Klickverschluss 1 1/4"
- 2x Kupferrohr 300 mm wird empfohlen

Washbasin 3-hole mixer 1/2"

- spout projection 150 mm; height 270 mm; swivelling spout
- 2 side valves with ceramic internal upper parts 1/2"
- push-open waste 1 1/4"
- 2x copper tube 300 mm recommended

A	B	C	D	E
996,-	1.299,-	1.424,-	1.499,-	1.909,-
F	G	H	I	L
1.732,-	1.423,-	1.679,-	2.098,-	2.863,-



638.10.333

Waschtisch 1-Hand Batterie

- Ausladung 150 mm; Höhe 300 mm
- Auslauf schwenkbar
- Kartusche mit keramischen Scheiben
- Exzenter-Ablaufgarnitur 1 1/4"
- 2 Kupferrohre M10x1 x 400 mm

Single lever washbasin mixer

- spout projection 150 mm; height 300 mm; swivelling spout
- cartridge with ceramic discs
- pop-up waste 1 1/4"
- 2 copper tubes M10x1 x 400 mm

A	B	C	D	E
699,-	989,-	1.096,-	1.154,-	1.469,-
F	G	H	I	L
1.332,-	1.192,-	1.408,-	1.616,-	2.596,-

Variante | Alternative

638.10.334

Waschtisch 1-Hand Batterie

- ohne Exzenter-Ablaufgarnitur

Single lever washbasin mixer

- without pop-up waste



A	B	C	D	E
654,-	886,-	938,-	1.054,-	1.309,-
F	G	H	I	L
1.208,-	1.076,-	1.266,-	1.438,-	2.098,-



638.10.353

Waschtisch 1-Hand Batterie, XXL

- Ausladung 220 mm; Höhe 355 mm
- Auslauf schwenkbar
- Kartusche mit keramischen Scheiben
- Exzenter-Ablaufgarnitur 1 1/4"
- 2 Kupferrohre M10x1 x 400 mm

Single lever washbasin mixer, XXL

- spout projection 220 mm; height 355 mm; swivelling spout
- cartridge with ceramic discs
- pop-up waste 1 1/4"
- 2 copper tubes M10x1 x 400 mm

A	B	C	D	E
816,-	1.068,-	1.188,-	1.264,-	1.624,-
F	G	H	I	L
1.466,-	1.256,-	1.528,-	1.796,-	2.689,-

Variante | Alternative

638.10.354

Waschtisch 1-Hand Batterie, XXL

- ohne Exzenter-Ablaufgarnitur

Single lever washbasin mixer, XXL

- without pop-up waste



A	B	C	D	E
767,-	978,-	1.068,-	1.178,-	1.436,-
F	G	H	I	L
1.299,-	1.064,-	1.258,-	1.598,-	2.189,-



638.10.352

Waschtisch 1-Hand Batterie, XXL

- mit Rohrverlängerung 150 mm
- Ausladung 220 mm; Höhe 505 mm
- Auslauf schwenkbar
- Kartusche mit keramischen Scheiben
- ohne Ablaufventil
- 2 Kupferrohre M10x1 x 600 mm

Single lever washbasin mixer, XXL

- with body extension 150 mm
- spout projection 220 mm; height 505 mm; swivelling spout
- cartridge with ceramic discs
- without waste
- 2 copper tubes M10x1 x 600 mm

A	B	C	D	E
991,-	1.306,-	1.428,-	1.576,-	1.922,-
F	G	H	I	L
1.739,-	1.520,-	1.850,-	2.147,-	3.257,-

VALENCIA

Maßzeichnungen unter www.joerger.de - Menü SERVICE.
 Technical specifications under www.joerger.de - menu SERVICE.

A chrom chrome	[.000]	E platin matt platinum matt	[.066]
B silbernickel polished nickel	[.035]	F nerz matt milk matt	[.096]
C nerz milk	[.095]	G schwarz-matt black matt	[.092]
C nickel matt satin nickel	[.036]	G weiß-matt white matt	[.052]
D edelmessing sunshine	[.040]	H bronze bronze	[.011]
D platin platinum	[.065]	I gold gold	[.020]
E edelmess.matt sunshine matt	[.041]	L rosé-gold rose-gold	[.022]
E gold matt gold matt	[.021]	L rosé-gold matt rose-gold matt	[.023]

-12 schwarz black	mit Aufpreis / with surcharge	-55 Labradorit Labradorite
-21 weiß white	-51 Weißer Türkis White turquoise	-56 blauer Avanturin blue Aventurine
	-52 Schwarzer Marmor Black Marble	
	-53 Amethyst Amethyst	
	-54 Malachit Malachite	

Wand-Waschtisch Batterien | Wall-Washbasin mixer

	638.30.360 Wand-Waschtisch 3-Loch Batterie, Fertigmontageset ■ Wand-Auslauf, Ausladung 235 mm ■ Griff, Hülse, Schubrosette ■ Oberteile ½", keramische Scheiben	Wall washbasin 3-hole mixer, assembly set ■ wall spout, projection 235 mm ■ design handle, socket with adjustable escutcheon ■ cartridges ½", with ceramic discs	A	B	C	D	E
			908,-	1.108,-	1.182,-	1.238,-	1.549,-
			F	G	H	I	L
			1.414,-	1.288,-	1.519,-	1.696,-	2.739,-

Benötigt | Required

	649.30.380 Wand-Waschtisch 3-Loch Batterie, Einbaukörper ½" ■ 2 Anschlüsse, Stichmaß 204 mm ■ zu Fertigmontageset 638.30.360	Wall washbasin 3-hole mixer concealed body ½" ■ 2 connections, center dist. 204 mm ■ for assembly set 638.30.360	A				
			296,-				

	638.20.360 Wand-Waschtisch 1-Hand Batterie ½", Fertigmontageset ■ Wand-Auslauf, Ausladung 215 mm ■ Wandrosetten	Single lever wall washbasin mixer ½", assembly set ■ wall spout, projection 215 mm ■ escutcheons	A	B	C	D	E
			806,-	1.012,-	1.099,-	1.189,-	1.482,-
			F	G	H	I	L
			1.344,-	1.184,-	1.449,-	1.628,-	2.659,-

Benötigt | Required

	649.20.362 Wand-Waschtisch 1-Hand Batterie ½", Einbaukörper ■ Bedienehebel rechts ■ zu Fertigmontageset 638.20.360 ■ Kartusche mit ker. Scheiben	Single lever wall washbasin mixer ½", concealed body ■ control lever on the right ■ for assembly set 638.20.360 ■ cartridge with ceramic discs	A				
			258,-				

	649.20.364 Wand-Waschtisch 1-Hand Batterie ½", Einbaukörper ■ Bedienehebel links ■ zu Fertigmontageset 638.20.360 ■ Kartusche mit ker. Scheiben	Single lever wall washbasin mixer ½", concealed body ■ control lever on the left ■ for assembly set 638.20.360 ■ cartridge with ceramic discs	A				
			258,-				

Waschtisch Batterien, bodenstehend | Washbasin mixer, free standing

	638.10.854 Waschtisch 1-Hand Batterie ■ für freistehende Montage ■ Ausladung 240 mm ■ Auslauf schwenkbar ■ ohne Ablaufgarnitur ■ Standrohr mit Befestigungsflansch ■ Luftsprudler ■ Kartusche mit keramischen Scheiben ■ Höhe gesamt 1205 - 1285 mm ■ Höhe bis Luftsprudler 1090 - 1170 mm	Single lever washbasin mixer ■ free standing assembly ■ spout projection 240 mm ■ swivelling spout ■ without waste ■ Pillar tube with flange ■ aerator ■ ceramic internal upper part ■ height 1205 - 1285 mm ■ aerator height 1090 - 1170 mm	A	B	C	D	E
			1.836,-	2.378,-	2.639,-	2.794,-	3.599,-
			F	G	H	I	L
			3.259,-	2.772,-	3.329,-	3.972,-	5.138,-

Benötigt | Required

	649.10.970 Bausatz-Vormontage ■ Bodenplatte mit Befestigungsset ■ zu Fertigmontageset 638.10.854	Assembly set for pre-installation ■ joint plate with fixing set ■ for assembly set 638.10.854	A				
			549,-				

Maßzeichnungen unter www.joerger.de - Menü SERVICE.
 Technical specifications under www.joerger.de - menu SERVICE.

A chrom chrome	[.000]	E platin matt platinum matt	[.066]
B silbernickel polished nickel	[.035]	F nerz matt milk matt	[.096]
C nerz milk	[.095]	G schwarz-matt black matt	[.092]
C nickel matt satin nickel	[.036]	G weiß-matt white matt	[.052]
D edelmessing sunshine	[.040]	H bronze bronze	[.011]
D platin platinum	[.065]	I gold gold	[.020]
E edelmess.matt sunshine matt	[.041]	L rosé-gold rose-gold	[.022]
E gold matt gold matt	[.021]	L rosé-gold matt rose-gold matt	[.023]

-12 schwarz | black
 -21 weiß | white

mit Aufpreis / with surcharge

-51 Weißer Türkis | White turquoise
 -52 Schwarzer Marmor | Black Marble
 -53 Amethyst | Amethyst
 -54 Malachit | Malachite
 -55 Labradorit | Labradorite
 -56 blauer Avanturin | blue Aventurine

Bidet Batterien | Bidet mixer



638.10.111

Bidet 1-Hand Batterie

- Ausladung 120 mm; Höhe 200 mm
- Auslauf schwenkbar
- Kartusche mit keramischen Scheiben
- Exzenter-Ablaufgarnitur 1 ¼"
- 2 Druckschläuche M10x1 x 450 mm

Single lever bidet mixer

- spout projection 120 mm; height 200 mm
- swivelling spout
- cartridge with ceramic discs
- pop-up waste 1 ¼"
- 2 pressure hoses M10x1 x 450 mm

A	B	C	D	E
765,-	1.044,-	1.154,-	1.339,-	1.492,-
F	G	H	I	L
1.399,-	1.279,-	1.484,-	1.826,-	2.679,-

Zubehör für Waschtisch- und Bidet-Batterien | Supplies for washbasin and bidet mixer



638.12.100

Eckventil ½"

- Ausladung 110 mm
- Fettkammer-Innenoberteil ½"
- Quetschverschraubung
- Schubrosette

Angle valve ½"

- projection 110 mm
- cartridge ½"
- compression joint
- escutcheon

A	B	C	D	E
141,-	184,-	223,-	289,-	415,-
F	G	H	I	L
365,-	232,-	408,-	499,-	650,-

649.15.530

Kupferrohr, 300 mm

- mit Bördel, für Quetschverschraubung

Copper tube, 300 mm

- with flange, for compression joint

A	B	C	D	E
15,-	38,-	55,-	62,-	74,-
F	G	H	I	L
69,-	75,-	94,-	112,-	169,-

Variante | Alternative

649.15.550

Kupferrohr, 500 mm

- mit Bördel, für Quetschverschraubung

Copper tube, 500 mm

- with flange, for compression joint

A	B	C	D	E
20,-	58,-	77,-	87,-	102,-
F	G	H	I	L
97,-	77,-	96,-	134,-	219,-



649.15.340

Waschtisch-Tassensiphon 1 ¼"

- schwere Ausführung
- Rosette
- Abgangsrohr ø 32 mm
- Tauchrohrlänge 165 mm

Washbasin cupped siphon trap 1 ¼"

- heavy brass
- escutcheon
- outlet tube ø 32 mm
- dip pipe 165 mm

A	B	C	D	E
195,-	296,-	368,-	429,-	568,-
F	G	H	I	L
498,-	378,-	539,-	686,-	832,-



649.15.270

Zwangsablaufventil

- Schaftlänge 70 mm
- für Waschbecken ohne Überlauf

Restraint drain/waste

- length of shaft 70 mm
- for washbasins without overflow

A	B	C	D	E
68,-	129,-	185,-	239,-	312,-
F	G	H	I	L
299,-	176,-	394,-	429,-	582,-

Maßzeichnungen unter www.joerger.de - Menü SERVICE.
 Technical specifications under www.joerger.de - menu SERVICE.

A chrom chrome	[.000]	E platin matt platinum matt	[.066]
B silbernickel polished nickel	[.035]	F nerz matt milk matt	[.096]
C nerz milk	[.095]	G schwarz-matt black matt	[.092]
C nickel matt satin nickel	[.036]	G weiß-matt white matt	[.052]
D edelmessing sunshine	[.040]	H bronze bronze	[.011]
D platin platinum	[.065]	I gold gold	[.020]
E edelmess.matt sunshine matt	[.041]	L rosé-gold rose-gold	[.022]
E gold matt gold matt	[.021]	L rosé-gold matt rose-gold matt	[.023]

-12 schwarz black	mit Aufpreis / with surcharge	-55 Labradorit Labradorite
-21 weiß white	-51 Weißer Türkis White turquoise	-56 blauer Avanturin blue Aventurine
	-52 Schwarzer Marmor Black Marble	
	-53 Amethyst Amethyst	
	-54 Malachit Malachite	

Badewanne, Stand-Batterien | Bath tub mixer sets, deck mount

	638.40.105 4-Loch Wannenfüll- und Brausebatterie 1/2", für Standmontage <ul style="list-style-type: none"> ■ Ausladung 225 mm; Höhe 290 mm ■ Auslauf starr ■ 2 Seitenrandventile mit keramischen Oberteilen 1/2" ■ Metall-Brauseschlauch 2000 mm ■ Metall-Handbrause mit Anti-Kalk-System und Rückflussverhinderer 	Tub/shower mixer set 1/2" deck mount <ul style="list-style-type: none"> ■ spout projection 225 mm; height 290 mm ■ fixed spout ■ 2 side valves, 1/2" cer. internal upper parts, metal shower hose 2000 mm ■ metal hand shower with anticalc. system and backflow preventer 	A	B	C	D	E
			1.746,-	2.163,-	2.265,-	2.412,-	2.856,-
			F	G	H	I	L
			2.654,-	2.198,-	2.941,-	3.265,-	4.136,-

	638.40.155 4-Loch Wannenrandkombination 1/2" <ul style="list-style-type: none"> ■ für Ab- und Überlaufgarnitur mit Wanneneinlauf, ohne Rohrunterbrecher ■ 2 Seitenrandventile mit keramischen Oberteilen 1/2", 2-Wege Umstellung ■ Metall-Brauseschlauch 2000 mm ■ Metall-Handbrause mit Anti-Kalk-System und Rückflussverhinderer 	tub/shower combination 1/2" <ul style="list-style-type: none"> ■ for waste and overflow set with bath tub filler spout, without pipe interrupter ■ 2 side valves, 1/2" cer. internal upper parts, 2-position diverter ■ metal shower hose 2000 mm ■ metal hand shower with anticalc. system and backflow preventer 	A	B	C	D	E
			1.390,-	1.799,-	1.919,-	2.054,-	2.514,-
			F	G	H	I	L
			2.294,-	1.938,-	2.624,-	2.984,-	3.754,-

Empfohlen | Recommended

	649.40.160 Montageplatte, komplett <ul style="list-style-type: none"> ■ für 4-Loch Armaturen ■ Druckschläuche 1/2" x 1/2" x 600 mm ■ empfohlen: Schlauchkastensystem siehe Kapitel "Serienübergreifendes" 	Assembly plate, complete <ul style="list-style-type: none"> ■ for deck mounted tub/shower mixer ■ pressure hoses 1/2"x 1/2" x 600 mm ■ recommended: system with hose box see chapter "universal products" 	A				
			308,-				

	638.40.100 4-Loch Wannenfüll- und Brausebatterie 1/2", für Standmontage <ul style="list-style-type: none"> ■ Ausladung 225 mm; Höhe 290 mm ■ Auslauf starr ■ 2 Seitenrandventile mit keramischen Oberteilen 1/2" ■ Metall-Brauseschlauch 2000 mm ■ Metall-Handbrause mit Anti-Kalk-System und Rückflussverhinderer 	Tub/shower mixer set 1/2" deck mount <ul style="list-style-type: none"> ■ spout projection 225 mm; height 290 mm ■ fixed spout ■ 2 side valves, 1/2" cer. internal upper parts, metal shower hose 2000 mm ■ metal hand shower with anticalc. system and backflow preventer 	A	B	C	D	E
			1.652,-	1.924,-	2.028,-	2.174,-	2.592,-
			F	G	H	I	L
			2.376,-	2.036,-	2.679,-	2.926,-	3.669,-

	638.40.150 4-Loch Wannenrandkombination 1/2" <ul style="list-style-type: none"> ■ für Ab- und Überlaufgarnitur mit Wanneneinlauf, ohne Rohrunterbrecher ■ 2 Seitenrandventile mit keramischen Oberteilen 1/2", 2-Wege Umstellung ■ Metall-Brauseschlauch 2000 mm ■ Metall-Handbrause mit Anti-Kalk-System und Rückflussverhinderer 	tub/shower combination 1/2" <ul style="list-style-type: none"> ■ for waste and overflow set with bath tub filler spout, without pipe interrupter ■ 2 side valves, 1/2" cer. internal upper parts, 2-position diverter ■ metal shower hose 2000 mm ■ metal hand shower with anticalc. system and backflow preventer 	A	B	C	D	E
			1.296,-	1.562,-	1.682,-	1.815,-	2.199,-
			F	G	H	I	L
			2.016,-	1.775,-	2.362,-	2.499,-	3.286,-

Empfohlen | Recommended

	649.40.160 Montageplatte, komplett <ul style="list-style-type: none"> ■ für 4-Loch Armaturen ■ Druckschläuche 1/2" x 1/2" x 600 mm ■ empfohlen: Schlauchkastensystem siehe Kapitel "Serienübergreifendes" 	Assembly plate, complete <ul style="list-style-type: none"> ■ for deck mounted tub/shower mixer ■ pressure hoses 1/2"x 1/2" x 600 mm ■ recommended: system with hose box see chapter "universal products" 	A				
			308,-				

VALENCIA

Maßzeichnungen unter www.joerger.de - Menü SERVICE.
 Technical specifications under www.joerger.de - menu SERVICE.



A chrom chrome	[.000]	E platin matt platinum matt	[.066]
B silbernickel polished nickel	[.035]	F nerz matt milk matt	[.096]
C nerz milk	[.095]	G schwarz-matt black matt	[.092]
C nickel matt satin nickel	[.036]	G weiß-matt white matt	[.052]
D edelmessing sunshine	[.040]	H bronze bronze	[.011]
D platin platinum	[.065]	I gold gold	[.020]
E edelmess.matt sunshine matt	[.041]	L rosé-gold rose-gold	[.022]
E gold matt gold matt	[.021]	L rosé-gold matt rose-gold matt	[.023]

-12 schwarz | black
 -21 weiß | white



mit Aufpreis / with surcharge

-51 Weißer Türkis | White turquoise
 -52 Schwarzer Marmor | Black Marble
 -53 Amethyst | Amethyst
 -54 Malachit | Malachite
 -55 Labradorit | Labradorite
 -56 blauer Avanturin | blue Aventurine

Badewanne, Aufputz-Batterien | Bath tub mixer sets, exposed

	638.20.105 Wannenfüll- und Brausebatterie für Aufputzmontage, mit Garnitur <ul style="list-style-type: none"> ■ Ausladung 235 mm ■ Höhe 257 mm, Auslauf starr ■ Metall-Handbrause mit Anti-Kalk-System und Rückflussverhinderer ■ Metall-Brauseschlauch 1500 mm, beidseitig mit drehbarem Konus 	Exposed tub/shower mixer ½", incl. shower set <ul style="list-style-type: none"> ■ spout projection 235 mm ■ height 257 mm, fixed spout ■ metal hand shower with anticalc. system and backflow preventer ■ metal shower hose 1500 mm, both sides with turning cone 	A	B	C	D	E
			1.980,-	2.797,-	3.113,-	3.490,-	4.160,-
			F	G	H	I	L
			3.830,-	2.392,-	3.838,-	4.696,-	5.646,-
	638.20.100 Wannenfüll- und Brausebatterie für Aufputzmontage, mit Garnitur <ul style="list-style-type: none"> ■ Ausladung 235 mm ■ Höhe 257 mm, Auslauf starr ■ Metall-Handbrause mit Anti-Kalk-System und Rückflussverhinderer ■ Metall-Brauseschlauch 1500 mm, beidseitig mit drehbarem Konus 	Exposed tub/shower mixer ½", incl. shower set <ul style="list-style-type: none"> ■ spout projection 235 mm ■ height 257 mm, fixed spout ■ metal hand shower with anticalc. system and backflow preventer ■ metal shower hose 1500 mm, both sides with turning cone 	A	B	C	D	E
			1.886,-	2.558,-	2.876,-	3.252,-	3.896,-
			F	G	H	I	L
			3.552,-	2.229,-	3.576,-	4.357,-	5.179,-
	638.11.100 Wand-Wanneneinlauf ½" <ul style="list-style-type: none"> ■ Ausladung 250 mm ■ Steckanschluß-Montage 	Tub wall spout ½" <ul style="list-style-type: none"> ■ spout projection 250 mm ■ special concealed wall attachment 	A	B	C	D	E
			448,-	579,-	697,-	787,-	914,-
			F	G	H	I	L
			858,-	597,-	694,-	1.045,-	1.568,-

Badewanne, Stand-Batterien | Bath tub mixer sets, free standing

	638.10.825 Wannen 1-Hand Batterie <ul style="list-style-type: none"> ■ für freistehende Montage ■ Ausladung 355 mm ■ Auslauf schwenkbar ■ Umstellung Wanne/Brause ■ Metall-Handbrause mit Anti-Kalk-System und Rückflussverhinderer ■ Metall-Brauseschlauch 1500 mm ■ Standrohr mit Befestigungsflansch ■ Luftsprudler ■ Kartusche mit keramischen Scheiben ■ Höhe gesamt 940 - 1020 mm ■ Höhe bis Luftsprudler 765 - 845 mm 	Tub/shower mixer set <ul style="list-style-type: none"> ■ free standing assembly ■ spout projection 355 mm ■ swivelling spout ■ diverter spout/hand shower ■ metal hand shower with anticalc. system and backflow preventer ■ metal shower hose 1500 mm ■ Pillar tube with flange ■ aerator ■ ceramic internal upper part ■ height 940 - 1020 mm ■ aerator height 765 - 845 mm 	A	B	C	D	E
			2.459,-	3.377,-	3.536,-	3.956,-	4.843,-
			F	G	H	I	L
			4.387,-	3.150,-	4.586,-	5.817,-	6.806,-
	649.10.970 Bausatz-Vormontage <ul style="list-style-type: none"> ■ Bodenplatte mit Befestigungsset ■ zu Fertigmontageset 638.10.820 	Assembly set for pre-installation <ul style="list-style-type: none"> ■ joint plate with fixing set ■ for assembly set 638.10.820 	A				
			549,-				

VALENCIA

Maßzeichnungen unter www.joerger.de - Menü SERVICE.
 Technical specifications under www.joerger.de - menu SERVICE.

A chrom chrome	[.000]	E platin matt platinum matt	[.066]
B silbernickel polished nickel	[.035]	F nerz matt milk matt	[.096]
C nerz milk	[.095]	G schwarz-matt black matt	[.092]
C nickel matt satin nickel	[.036]	G weiß-matt white matt	[.052]
D edelmessing sunshine	[.040]	H bronze bronze	[.011]
D platin platinum	[.065]	I gold gold	[.020]
E edelmess.matt sunshine matt	[.041]	L rosé-gold rose-gold	[.022]
E gold matt gold matt	[.021]	L rosé-gold matt rose-gold matt	[.023]

-12 schwarz black	mit Aufpreis / with surcharge	
-21 weiß white	-51 Weißer Türkis White turquoise	-55 Labradorit Labradorite
	-52 Schwarzer Marmor Black Marble	-56 blauer Avanturin blue Aventurine
	-53 Amethyst Amethyst	
	-54 Malachit Malachite	

Badewanne, Stand-Batterien | Bath tub mixer sets, free standing

Variante | Alternative



638.10.820 Wannen 1-Hand Batterie	Tub/shower mixer set
<ul style="list-style-type: none"> ■ für freistehende Montage ■ Ausladung 355 mm ■ Auslauf schwenkbar ■ Umstellung Wanne/Brause ■ Metall-Handbrause mit Anti-Kalk-System und Rückflussverhinderer ■ Metall-Brauseschlauch 1500 mm ■ Standrohr mit Befestigungsflansch ■ Luftsprudler ■ Kartusche mit keramischen Scheiben ■ Höhe gesamt 940 - 1020 mm ■ Höhe bis Luftsprudler 765 - 845 mm 	<ul style="list-style-type: none"> ■ free standing assembly ■ spout projection 355 mm ■ swivelling spout ■ diverter spout/hand shower ■ metal hand shower with anticalc. system and backflow preventer ■ metal shower hose 1500 mm ■ Pillar tube with flange ■ aerator ■ ceramic internal upper part ■ height 940 - 1020 mm ■ aerator height 765 - 845 mm

A	B	C	D	E
2.367,-	3.138,-	3.299,-	3.718,-	4.579,-
F	G	H	I	L
4.109,-	2.988,-	4.324,-	5.478,-	6.339,-

Benötigt | Required

649.10.970 Bausatz-Vormontage	Assembly set for pre-installation
<ul style="list-style-type: none"> ■ Bodenplatte mit Befestigungsset ■ zu Fertigmontageset 638.10.820 	<ul style="list-style-type: none"> ■ joint plate with fixing set ■ for assembly set 638.10.820



A	B	C	D	E
549,-				

Dusche, Aufputz-Batterien | Shower mixer sets, exposed



638.20.200 Brausebatterie 1/2" für Aufputzmontage	Exposed shower mixer 1/2"
<ul style="list-style-type: none"> ■ 2 keramische Oberteile 1/2" ■ Brauseabgang 1/2" ■ verdeckte S-Anschlüsse 1/2" x 3/4" 	<ul style="list-style-type: none"> ■ 2 ceramic internal upper parts 1/2" ■ discharge 1/2" ■ concealed S-connections 1/2" x 3/4"

A	B	C	D	E
1.192,-	1.586,-	1.749,-	1.868,-	2.492,-
F	G	H	I	L
2.239,-	1.838,-	2.244,-	2.783,-	3.259,-

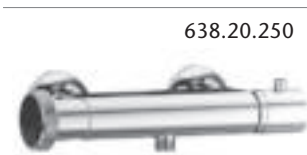

638.20.250 Brausethermostat 1/2" für Aufputzmontage	Exposed shower thermostat 1/2"
<ul style="list-style-type: none"> ■ Dehnstoff-Thermoelement ■ Sicherheitssperre bei 38° C ■ Keramik-Innenoberteil 1/2" 	<ul style="list-style-type: none"> ■ cartridge with thermoelement ■ heat scale and locking device at 38 °C ■ ceramic cartridge 1/2"

A	B	C	D	E
1.098,-	1.492,-	1.655,-	1.774,-	2.398,-
F	G	H	I	L
2.145,-	1.744,-	2.150,-	2.689,-	3.165,-

VALENCIA

Maßzeichnungen unter www.joerger.de - Menü SERVICE.
 Technical specifications under www.joerger.de - menu SERVICE.

A chrom chrome	[.000]	E platin matt platinum matt	[.066]
B silbernickel polished nickel	[.035]	F nerz matt mink matt	[.096]
C nerz mink	[.095]	G schwarz-matt black matt	[.092]
C nickel matt satin nickel	[.036]	G weiß-matt white matt	[.052]
D edelmessing sunshine	[.040]	H bronze bronze	[.011]
D platin platinum	[.065]	I gold gold	[.020]
E edelmess.matt sunshine matt	[.041]	L rosé-gold rose-gold	[.022]
E gold matt gold matt	[.021]	L rosé-gold matt rose-gold matt	[.023]

-12 schwarz | black
 -21 weiß | white

mit Aufpreis / with surcharge

-51 Weißer Türkis | White turquoise
 -52 Schwarzer Marmor | Black Marble
 -53 Amethyst | Amethyst
 -54 Malachit | Malachite
 -55 Labradorit | Labradorite
 -56 blauer Avanturin | blue Aventurine

638.20.415 – Aufputz Set mit Steigrohr | Exposed set with shower system

	649.13.844	Regenbrause 1/2", ø 240 mm <ul style="list-style-type: none"> Ausführung ganz in Metall 3 mm ultra flach mit Kugelgelenk Anti-Kalk-System 	Rain shower head 1/2", ø 240 mm <ul style="list-style-type: none"> full metal body 3 mm ultra-thin with ball joint with anticalcareous system 	A	B	C	D	E
				499,-	1.098,-	1.289,-	1.372,-	1.622,-
				F	G	H	I	L
				1.452,-	1.289,-	1.599,-	1.927,-	2.529,-
	649.20.210	Steigrohr, Umstellung, Wandarm <ul style="list-style-type: none"> zum Anschluss an die Brausebatterie Ausladung 360 - 380 mm in der Neigung und Höhe verstellbare Brausehalterung 	Supply pipe, diverter, wall bracket <ul style="list-style-type: none"> to connect the exposed shower mixer projection 360 - 380 mm fitting for handshower adjustable in height and inclination 	A	B	C	D	E
			568,-	972,-	1.109,-	1.182,-	1.639,-	
			F	G	H	I	L	
			1.455,-	1.289,-	1.806,-	1.949,-	2.598,-	
	632.13.705	Brausegarnitur <ul style="list-style-type: none"> Metall-Handbrause mit Anti-Kalk-System und Rückflussverhinderer Metall-Brauseschlauch 1500 mm, beidseitig mit drehbarem Konus 	Shower combination <ul style="list-style-type: none"> metal hand shower with anticalc. system and backflow preventer metal shower hose 1500 mm, both sides with turning cone 	A	B	C	D	E
			279,-	499,-	599,-	648,-	796,-	
			F	G	H	I	L	
			784,-	719,-	1.064,-	1.294,-	1.778,-	
	638.20.210	Brausebatterie 1/2" für Steigrohr-Montage <ul style="list-style-type: none"> 2 keramische Oberteile 1/2" Brauseabgang 3/4" verdeckte S-Anschlüsse 1/2" x 3/4" 	Exposed shower mixer 1/2" for supply pipe <ul style="list-style-type: none"> 2 ceramic internal upper parts 1/2" discharge 3/4" concealed S-connections 1/2" x 3/4" 	A	B	C	D	E
			1.198,-	1.592,-	1.755,-	1.874,-	2.498,-	
			F	G	H	I	L	
			2.245,-	1.844,-	2.250,-	2.789,-	3.265,-	

638.20.410 – Aufputz Set mit Steigrohr | Exposed set with shower system

	649.13.844	Regenbrause 1/2", ø 240 mm <ul style="list-style-type: none"> Ausführung ganz in Metall 3 mm ultra flach mit Kugelgelenk Anti-Kalk-System 	Rain shower head 1/2", ø 240 mm <ul style="list-style-type: none"> full metal body 3 mm ultra-thin with ball joint with anticalcareous system 	A	B	C	D	E
				499,-	1.098,-	1.289,-	1.372,-	1.622,-
				F	G	H	I	L
				1.452,-	1.289,-	1.599,-	1.927,-	2.529,-
	649.20.210	Steigrohr, Umstellung, Wandarm <ul style="list-style-type: none"> zum Anschluss an die Brausebatterie Ausladung 360 - 380 mm in der Neigung und Höhe verstellbare Brausehalterung 	Supply pipe, diverter, wall bracket <ul style="list-style-type: none"> to connect the exposed shower mixer projection 360 - 380 mm fitting for handshower adjustable in height and inclination 	A	B	C	D	E
			568,-	972,-	1.109,-	1.182,-	1.639,-	
			F	G	H	I	L	
			1.455,-	1.289,-	1.806,-	1.949,-	2.598,-	
	630.13.700	Brausegarnitur <ul style="list-style-type: none"> Metall-Handbrause mit Anti-Kalk-System und Rückflussverhinderer Metall-Brauseschlauch 1500 mm, beidseitig mit drehbarem Konus 	Shower combination <ul style="list-style-type: none"> metal hand shower with anticalc. system and backflow preventer metal shower hose 1500 mm, both sides with turning cone 	A	B	C	D	E
			146,-	312,-	466,-	519,-	624,-	
			F	G	H	I	L	
			566,-	586,-	929,-	1.149,-	1.643,-	
	638.20.210	Brausebatterie 1/2" für Steigrohr-Montage <ul style="list-style-type: none"> 2 keramische Oberteile 1/2" Brauseabgang 3/4" verdeckte S-Anschlüsse 1/2" x 3/4" 	Exposed shower mixer 1/2" for supply pipe <ul style="list-style-type: none"> 2 ceramic internal upper parts 1/2" discharge 3/4" concealed S-connections 1/2" x 3/4" 	A	B	C	D	E
			1.198,-	1.592,-	1.755,-	1.874,-	2.498,-	
			F	G	H	I	L	
			2.245,-	1.844,-	2.250,-	2.789,-	3.265,-	

VALENCIA

Maßzeichnungen unter www.joerger.de - Menü SERVICE.
 Technical specifications under www.joerger.de - menu SERVICE.

A chrom chrome	[.000]	E platin matt platinum matt	[.066]
B silbernickel polished nickel	[.035]	F nerz matt milk matt	[.096]
C nerz milk	[.095]	G schwarz-matt black matt	[.092]
C nickel matt satin nickel	[.036]	G weiß-matt white matt	[.052]
D edelmessing sunshine	[.040]	H bronze bronze	[.011]
D platin platinum	[.065]	I gold gold	[.020]
E edelmess.matt sunshine matt	[.041]	L rosé-gold rose-gold	[.022]
E gold matt gold matt	[.021]	L rosé-gold matt rose-gold matt	[.023]

-12 schwarz black	mit Aufpreis / with surcharge	
-21 weiß white	-51 Weißer Türkis White turquoise	-55 Labradorit Labradorite
	-52 Schwarzer Marmor Black Marble	-56 blauer Avanturin blue Aventurine
	-53 Amethyst Amethyst	
	-54 Malachit Malachite	

638.20.465 – Aufputz Set mit Steigrohr | Exposed set with shower system

	649.13.844	Regenbrause 1/2", ø 240 mm <ul style="list-style-type: none"> Ausführung ganz in Metall 3 mm ultra flach mit Kugelgelenk Anti-Kalk-System 	Rain shower head 1/2", ø 240 mm <ul style="list-style-type: none"> full metal body 3 mm ultra-thin with ball joint with anticalcareous system 	A	B	C	D	E
				499,-	1.098,-	1.289,-	1.372,-	1.622,-
				F	G	H	I	L
				1.452,-	1.289,-	1.599,-	1.927,-	2.529,-
	649.20.210	Steigrohr, Umstellung, Wandarm <ul style="list-style-type: none"> zum Anschluss an die Brausebatterie Ausladung 360 - 380 mm in der Neigung und Höhe verstellbare Brausehalterung 	Supply pipe, diverter, wall bracket <ul style="list-style-type: none"> to connect the exposed shower mixer projection 360 - 380 mm fitting for handshower adjustable in height and inclination 	A	B	C	D	E
				568,-	972,-	1.109,-	1.182,-	1.639,-
				F	G	H	I	L
				1.455,-	1.289,-	1.806,-	1.949,-	2.598,-
	632.13.705	Brausegarnitur <ul style="list-style-type: none"> Metall-Handbrause mit Anti-Kalk-System und Rückflussverhinderer Metall-Brauseschlauch 1500 mm, beidseitig mit drehbarem Konus 	Shower combination <ul style="list-style-type: none"> metal hand shower with anticalc. system and backflow preventer metal shower hose 1500 mm, both sides with turning cone 	A	B	C	D	E
				279,-	499,-	599,-	648,-	796,-
				F	G	H	I	L
				784,-	719,-	1.064,-	1.294,-	1.778,-
638.20.260	Brausethermostat 1/2" für Steigrohr-Montage <ul style="list-style-type: none"> Dehnstoff-Thermoelement Sicherheitsperre bei 38° C Keramik-Innenoberteil 1/2" Brauseabgang 3/4" verdeckte S-Anschlüsse 1/2" x 3/4" 	Exposed shower thermostat 1/2" for supply pipe <ul style="list-style-type: none"> cartridge with thermoelement locking device at 38 °C ceramic cartridge 1/2" discharge 3/4" concealed S-connections 1/2" x 3/4" 	A	B	C	D	E	
			1.146,-	1.539,-	1.706,-	1.822,-	2.446,-	
			F	G	H	I	L	
			2.194,-	1.792,-	2.198,-	2.738,-	3.214,-	

638.20.460 – Aufputz Set mit Steigrohr | Exposed set with shower system

	649.13.844	Regenbrause 1/2", ø 240 mm <ul style="list-style-type: none"> Ausführung ganz in Metall 3 mm ultra flach mit Kugelgelenk Anti-Kalk-System 	Rain shower head 1/2", ø 240 mm <ul style="list-style-type: none"> full metal body 3 mm ultra-thin with ball joint with anticalcareous system 	A	B	C	D	E
				499,-	1.098,-	1.289,-	1.372,-	1.622,-
				F	G	H	I	L
				1.452,-	1.289,-	1.599,-	1.927,-	2.529,-
	649.20.210	Steigrohr, Umstellung, Wandarm <ul style="list-style-type: none"> zum Anschluss an die Brausebatterie Ausladung 360 - 380 mm in der Neigung und Höhe verstellbare Brausehalterung 	Supply pipe, diverter, wall bracket <ul style="list-style-type: none"> to connect the exposed shower mixer projection 360 - 380 mm fitting for handshower adjustable in height and inclination 	A	B	C	D	E
				568,-	972,-	1.109,-	1.182,-	1.639,-
				F	G	H	I	L
				1.455,-	1.289,-	1.806,-	1.949,-	2.598,-
	630.13.700	Brausegarnitur <ul style="list-style-type: none"> Metall-Handbrause mit Anti-Kalk-System und Rückflussverhinderer Metall-Brauseschlauch 1500 mm, beidseitig mit drehbarem Konus 	Shower combination <ul style="list-style-type: none"> metal hand shower with anticalc. system and backflow preventer metal shower hose 1500 mm, both sides with turning cone 	A	B	C	D	E
				146,-	312,-	466,-	519,-	624,-
				F	G	H	I	L
				566,-	586,-	929,-	1.149,-	1.643,-
638.20.260	Brausethermostat 1/2" für Steigrohr-Montage <ul style="list-style-type: none"> Dehnstoff-Thermoelement Sicherheitsperre bei 38° C Keramik-Innenoberteil 1/2" Brauseabgang 3/4" verdeckte S-Anschlüsse 1/2" x 3/4" 	Exposed shower thermostat 1/2" for supply pipe <ul style="list-style-type: none"> cartridge with thermoelement locking device at 38 °C ceramic cartridge 1/2" discharge 3/4" concealed S-connections 1/2" x 3/4" 	A	B	C	D	E	
			1.146,-	1.539,-	1.706,-	1.822,-	2.446,-	
			F	G	H	I	L	
			2.194,-	1.792,-	2.198,-	2.738,-	3.214,-	

A chrom chrome	[.000]	E platin matt platinum matt	[.066]
B silbernickel polished nickel	[.035]	F nerz matt mink matt	[.096]
C nerz mink	[.095]	G schwarz-matt black matt	[.092]
C nickel matt satin nickel	[.036]	G weiß-matt white matt	[.052]
D edelmessing sunshine	[.040]	H bronze bronze	[.011]
D platin platinum	[.065]	I gold gold	[.020]
E edelmess.matt sunshine matt	[.041]	L rosé-gold rose-gold	[.022]
E gold matt gold matt	[.021]	L rosé-gold matt rose-gold matt	[.023]

-12 schwarz | black
 -21 weiß | white

mit Aufpreis / with surcharge

-51 Weißer Türkis | White turquoise
 -52 Schwarzer Marmor | Black Marble
 -53 Amethyst | Amethyst
 -54 Malachit | Malachite
 -55 Labradorit | Labradorite
 -56 blauer Avanturin | blue Aventurine

Unterputz-Hebelmischer 1/2" | Concealed single lever mixer 1/2"



638.20.125 1-Hand Wannenfüll- und Brausebatterie 1/2" für UP-Montage, Fertigmontageset
 ■ manuelle, keramische Umstellung für druckunabhängige Funktion
 ■ mit Sicherheitseinrichtung
 ■ Durchflussrate 21 l/min bei 3 bar

Concealed single lever wall tub and shower mixer 1/2", assembly set
 ■ manual, ceramic diverter tub/shower for pressure-independent function
 ■ with safety device
 ■ flow rate 21 l/min at 3 bar

A	B	C	D	E
959,-	1.196,-	1.292,-	1.342,-	1.654,-
F	G	H	I	L
1.559,-	1.292,-	1.584,-	1.786,-	2.279,-

Variante | Alternative



638.20.235 1-Hand Brausebatterie 1/2" für UP-Montage, Fertigmontageset
 ■ ohne Umstellung
 ■ Funktionseinheit mit ker. Scheiben
 ■ Durchflussrate 20,4 l/min bei 3 bar

Concealed single lever shower mixer 1/2", assembly set
 ■ without diverter
 ■ functional unit with ceramic discs
 ■ flow rate 20,4 l/min at 3 bar

A	B	C	D	E
754,-	910,-	1.066,-	1.105,-	1.394,-
F	G	H	I	L
1.284,-	1.066,-	1.336,-	1.519,-	1.879,-

Benötigt | Required



649.40.360 Unterputz-Einbaubox 1/2"
 ■ zu Fertigmontageset 638.20.125 und 638.20.235
 ■ für Nass- und Trockenbau geeignet

Concealed wall box 1/2"
 ■ for assembly set 638.20.125 and 638.20.235
 ■ for wetwall and drywall construction

A	B	C	D	E
168,-				

Unterputz-Thermostate 1/2" | Wall thermostats, concealed 1/2"



638.40.380 Unterputz-Thermostat 1/2" mit Mengenregulierung, Fertigmontageset
 ■ manuelle, keramische Umstellung Wanne/Brause, druckunabhängig
 ■ mit Sicherheitseinrichtung
 ■ Durchflussrate 20,4 l/min bei 3 bar

Concealed wall thermostat 1/2" with flow control, assembly set
 ■ manual, ceramic diverter tub/shower for pressure-independent function
 ■ with safety device
 ■ flow rate 20,4 l/min at 3 bar

A	B	C	D	E
1.196,-	1.442,-	1.599,-	1.658,-	1.975,-
F	G	H	I	L
1.859,-	1.599,-	1.899,-	2.109,-	2.692,-

Variante | Alternative



638.40.360 Unterputz-Thermostat 1/2" mit Mengenregulierung, Fertigmontageset
 ■ ohne Umstellung
 ■ mit integrierter keramischer Mengenregulierung
 ■ Durchflussrate 20,4 l/min bei 3 bar

Concealed wall thermostat 1/2" with flow control, assembly set
 ■ without diverter
 ■ with integrated ceramic cartridge for volume control
 ■ flow rate 20,4 l/min at 3 bar

A	B	C	D	E
1.164,-	1.416,-	1.575,-	1.627,-	1.946,-
F	G	H	I	L
1.849,-	1.575,-	1.875,-	2.082,-	2.682,-

Variante | Alternative



638.40.460 Unterputz-Thermostat 1/2" ohne Mengenregulierung, Fertigmontageset
 ■ Funktionseinheit ohne Umstellung und ohne Absperrung
 ■ Durchflussrate 25,8 l/min bei 3 bar

Concealed wall thermostat 1/2" without flow control, assembly set
 ■ Functional unit without diverter and without shut-off
 ■ flow rate 25,8 l/min at 3 bar

A	B	C	D	E
985,-	1.218,-	1.359,-	1.399,-	1.696,-
F	G	H	I	L
1.534,-	1.359,-	1.637,-	1.825,-	2.199,-

Benötigt | Required



649.40.360 Unterputz-Einbaubox 1/2"
 ■ zu Fertigmontageset 638.40.360, 638.40.380 und 638.40.460
 ■ für Nass- und Trockenbau geeignet

Concealed wall box 1/2"
 ■ for assembly set 638.40.360, 638.40.380 and 638.40.460
 ■ for wetwall and drywall construction



A	B	C	D	E
168,-				

Maßzeichnungen unter www.joerger.de - Menü SERVICE.
 Technical specifications under www.joerger.de - menu SERVICE.



A chrom chrome	[.000]	E platin matt platinum matt	[.066]
B silbernickel polished nickel	[.035]	F nerz matt mink matt	[.096]
C nerz mink	[.095]	G schwarz-matt black matt	[.092]
C nickel matt satin nickel	[.036]	G weiß-matt white matt	[.052]
D edelmessing sunshine	[.040]	H bronze bronze	[.011]
D platin platinum	[.065]	I gold gold	[.020]
E edelmess.matt sunshine matt	[.041]	L rosé-gold rose-gold	[.022]
E gold matt gold matt	[.021]	L rosé-gold matt rose-gold matt	[.023]

-12 schwarz black	mit Aufpreis / with surcharge	-55 Labradorit Labradorite
-21 weiß white	-51 Weißer Türkis White turquoise	-56 blauer Avanturin blue Aventurine
	-52 Schwarzer Marmor Black Marble	
	-53 Amethyst Amethyst	
	-54 Malachit Malachite	



Unterputz-Thermostat ¾" mit hohem Durchfluß | Wall thermostat, concealed ¾" with high flow

	638.40.555	Unterputz-Thermostat ¾" ohne Mengenregulierung, Fertigmontageset <ul style="list-style-type: none"> ■ serienbezogener Temperiergriff ■ Sicherheitssperre bei 38° C 	Concealed wall thermostat ¾" without flow control, assembly set <ul style="list-style-type: none"> ■ design handle for temp. control ■ locking device at 38°C 	<table border="1"> <tr><th>A</th><th>B</th><th>C</th><th>D</th><th>E</th></tr> <tr><td>697,-</td><td>1.026,-</td><td>1.105,-</td><td>1.158,-</td><td>1.469,-</td></tr> <tr><th>F</th><th>G</th><th>H</th><th>I</th><th>L</th></tr> <tr><td>1.329,-</td><td>1.105,-</td><td>1.352,-</td><td>1.669,-</td><td>2.497,-</td></tr> </table>	A	B	C	D	E	697,-	1.026,-	1.105,-	1.158,-	1.469,-	F	G	H	I	L	1.329,-	1.105,-	1.352,-	1.669,-	2.497,-
	A	B	C	D	E																			
	697,-	1.026,-	1.105,-	1.158,-	1.469,-																			
F	G	H	I	L																				
1.329,-	1.105,-	1.352,-	1.669,-	2.497,-																				
Benötigt Required																								
	649.40.555	Unterputz-Einbaukörper ¾" <ul style="list-style-type: none"> ■ zu Fertigmontageset 638.40.555 ■ Kartusche mit Schmutzfangsieben ■ für Nass- und Trockenbau geeignet ■ Durchflussrate 64,2 l/min bei 3 bar ■ <u>ohne</u> Absperrung 	Concealed thermostat body ¾" <ul style="list-style-type: none"> ■ for assembly set 638.40.555 ■ cartridge with filter screens ■ for wetwall and drywall construction ■ flow rate 64,2 l/min at 3 bar ■ <u>without</u> shut-off 	<table border="1"> <tr><th>A</th><th></th><th></th><th></th><th></th></tr> <tr><td>1.636,-</td><td></td><td></td><td></td><td></td></tr> </table>	A					1.636,-														
	A																							
	1.636,-																							

Unterputz-Thermostat ¾" | Wall thermostat, concealed ¾"

	638.40.520	Unterputz-Thermostat ¾" ohne Mengenregulierung, Fertigmontageset <ul style="list-style-type: none"> ■ serienbezogener Temperiergriff ■ Sicherheitssperre bei 38° C 	Concealed wall thermostat ¾" without flow control, assembly set <ul style="list-style-type: none"> ■ design handle for temp. control ■ locking device at 38°C 	<table border="1"> <tr><th>A</th><th>B</th><th>C</th><th>D</th><th>E</th></tr> <tr><td>697,-</td><td>1.026,-</td><td>1.105,-</td><td>1.158,-</td><td>1.469,-</td></tr> <tr><th>F</th><th>G</th><th>H</th><th>I</th><th>L</th></tr> <tr><td>1.329,-</td><td>1.105,-</td><td>1.352,-</td><td>1.669,-</td><td>2.497,-</td></tr> </table>	A	B	C	D	E	697,-	1.026,-	1.105,-	1.158,-	1.469,-	F	G	H	I	L	1.329,-	1.105,-	1.352,-	1.669,-	2.497,-
	A	B	C	D	E																			
	697,-	1.026,-	1.105,-	1.158,-	1.469,-																			
F	G	H	I	L																				
1.329,-	1.105,-	1.352,-	1.669,-	2.497,-																				
Benötigt Required																								
	649.40.520	Unterputz-Einbaukörper ¾" <ul style="list-style-type: none"> ■ zu Fertigmontageset 638.40.520 ■ Kartusche mit Schmutzfangsieben ■ für Nass- und Trockenbau geeignet ■ Durchflussrate 41 l/min bei 3 bar ■ <u>ohne</u> Absperrung 	Concealed thermostat body ¾" <ul style="list-style-type: none"> ■ for assembly set 638.40.520 ■ cartridge with filter screens ■ for wetwall and drywall construction ■ flow rate 41 l/min at 3 bar ■ <u>without</u> shut-off 	<table border="1"> <tr><th>A</th><th></th><th></th><th></th><th></th></tr> <tr><td>498,-</td><td></td><td></td><td></td><td></td></tr> </table>	A					498,-														
	A																							
	498,-																							

Unterputz-Thermostat/Ventil-Modul | Concealed thermostatic/wall-valve modul

	638.60.432	Unterputz-Ventil-Modul Fertigmontageset <ul style="list-style-type: none"> ■ Griff ■ Rosette 	Concealed wall-valve-modul assembly set <ul style="list-style-type: none"> ■ design handle ■ escutcheon 	<table border="1"> <tr><th>A</th><th>B</th><th>C</th><th>D</th><th>E</th></tr> <tr><td>274,-</td><td>316,-</td><td>329,-</td><td>338,-</td><td>414,-</td></tr> <tr><th>F</th><th>G</th><th>H</th><th>I</th><th>L</th></tr> <tr><td>382,-</td><td>378,-</td><td>469,-</td><td>579,-</td><td>769,-</td></tr> </table>	A	B	C	D	E	274,-	316,-	329,-	338,-	414,-	F	G	H	I	L	382,-	378,-	469,-	579,-	769,-
	A	B	C	D	E																			
	274,-	316,-	329,-	338,-	414,-																			
F	G	H	I	L																				
382,-	378,-	469,-	579,-	769,-																				
Benötigt Required																								
	649.20.610	Unterputz-Ventil-Modul, 1-fach <ul style="list-style-type: none"> ■ 1x Spindelventil ¾", rechtsschließend mit keram. Scheiben ■ 2 Abgänge ½", je 1x rechts/links möglich, gleichzeitig benutzbar 	Concealed wall-valve-modul, single <ul style="list-style-type: none"> ■ 1x spindle valve ¾", clockwise closure with ceramic discs ■ 2 outlets ½", each 1x right/left possible, simultaneously usable 	<table border="1"> <tr><th>A</th><th></th><th></th><th></th><th></th></tr> <tr><td>229,-</td><td></td><td></td><td></td><td></td></tr> </table>	A					229,-														
	A																							
	229,-																							
	649.20.620	Unterputz-Ventil-Modul, 2-fach <ul style="list-style-type: none"> ■ 2 Spindelventil ¾", rechtsschließend mit keram. Scheiben ■ 4 Abgänge ½", je 2x rechts/links möglich, gleichzeitig benutzbar ■ im Verbund maßgenaue Montage ■ erweiterbar mit 649.20.610 	Concealed wall-valve-modul, double <ul style="list-style-type: none"> ■ 2x spindle valve ¾", clockwise closure with ceramic discs ■ 4 outlets ½", each 2x right/left possible, simultaneously usable ■ precise assembly due to composite ■ expandable with 649.20.610 	<table border="1"> <tr><th>A</th><th></th><th></th><th></th><th></th></tr> <tr><td>458,-</td><td></td><td></td><td></td><td></td></tr> </table>	A					458,-														
	A																							
	458,-																							

A chrom chrome	[.000]	E platin matt platinum matt	[.066]
B silbernickel polished nickel	[.035]	F nerz matt milk matt	[.096]
C nerz milk	[.095]	G schwarz-matt black matt	[.092]
C nickel matt satin nickel	[.036]	G weiß-matt white matt	[.052]
D edelmessing sunshine	[.040]	H bronze bronze	[.011]
D platin platinum	[.065]	I gold gold	[.020]
E edelmess.matt sunshine matt	[.041]	L rosé-gold rose-gold	[.022]
E gold matt gold matt	[.021]	L rosé-gold matt rose-gold matt	[.023]

-12 schwarz | black
 -21 weiß | white

mit Aufpreis / with surcharge

-51 Weißer Türkis | White turquoise
 -52 Schwarzer Marmor | Black Marble
 -53 Amethyst | Amethyst
 -54 Malachit | Malachite

-55 Labradorit | Labradorite
 -56 blauer Avanturin | blue Aventurine

Benötigt | Required



649.20.630 Unterputz-Ventil-Modul, 3-fach
 ■ 3 Spindelventil ¾", rechtsschließend mit keram. Scheiben
 ■ 6 Abgänge ½", je 3x rechts/links möglich, gleichzeitig benutzbar
 ■ im Verbund maßgenauen Montage
 ■ erweiterbar mit 649.20.610

Concealed wall-valve-modul, triple
 ■ 3x spindle valve ¾", clockwise closure with ceramic discs
 ■ 6 outlets ½", each 3x right/left possible, simultaneously usable
 ■ precise assembly due to composite
 ■ expandable with 649.20.610

A	B	C	D	E
686,-				



638.40.460 Unterputz-Thermostat ½"
ohne Mengenregulierung, Fertigmontageset
 ■ Funktionseinheit ohne Umstellung und ohne Absperrung
 ■ Durchflussrate 25,8 l/min bei 3 bar

Concealed wall thermostat ½"
without flow control, assembly set
 ■ Functional unit without diverter and without shut-off
 ■ flow rate 25,8 l/min at 3 bar

A	B	C	D	E
985,-	1.218,-	1.359,-	1.399,-	1.696,-
F	G	H	I	L
1.534,-	1.359,-	1.637,-	1.825,-	2.199,-

Benötigt | Required

649.20.612 Anschlussadapter ½"
 ■ Anschlussadapter, Abschlußstopfen
 ■ passend zu Einbaubox 649.40.360



Connection adapter ½"
 ■ connection adapter, end plug
 ■ matching to wall box 649.40.360

A	B	C	D	E
122,-				



649.40.360 Unterputz-Einbaubox ½"
 ■ zu Fertigmontageset 638.40.460
 ■ für Nass- und Trockenbau geeignet

Concealed wall box ½"
 ■ for assembly set 638.40.460
 ■ for wetwall and drywall construction

A	B	C	D	E
168,-				



638.40.555 Unterputz-Thermostat ¾"
ohne Mengenregulierung, Fertigmontageset
 ■ serienbezogener Temperiergriff
 ■ Sicherheitsperre bei 38° C

Concealed wall thermostat ¾"
without flow control, assembly set
 ■ design handle for temp. control
 ■ locking device at 38° C

A	B	C	D	E
697,-	1.026,-	1.105,-	1.158,-	1.469,-
F	G	H	I	L
1.329,-	1.105,-	1.352,-	1.669,-	2.497,-

Benötigt | Required

649.20.634 Anschlussadapter ¾"
 ■ Anschlussadapter, Abschlußstopfen
 ■ passend zu Einbaukörper 649.40.555



Connection adapter ¾"
 ■ connection adapter, end plug
 ■ matching to wall body 649.40.555

A	B	C	D	E
146,-				



649.40.555 Unterputz-Einbaukörper ¾"
 ■ zu Fertigmontageset 638.40.555
 ■ Kartusche mit Schmutzfangsieben
 ■ für Nass- und Trockenbau geeignet
 ■ Durchflussrate 64,2 l/min bei 3 bar
 ■ ohne Absperrung

Concealed thermostat body ¾"
 ■ for assembly set 638.40.555
 ■ cartridge with filter screens
 ■ for wetwall and drywall construction
 ■ flow rate 64,2 l/min at 3 bar
 ■ without shut-off

A	B	C	D	E
1.636,-				

VALENCIA

Maßzeichnungen unter www.joerger.de - Menü SERVICE.
 Technical specifications under www.joerger.de - menu SERVICE.

A chrom chrome	[.000]	E platin matt platinum matt	[.066]
B silbernickel polished nickel	[.035]	F nerz matt mink matt	[.096]
C nerz mink	[.095]	G schwarz-matt black matt	[.092]
C nickel matt satin nickel	[.036]	G weiß-matt white matt	[.052]
D edelmessing sunshine	[.040]	H bronze bronze	[.011]
D platin platinum	[.065]	I gold gold	[.020]
E edelmess.matt sunshine matt	[.041]	L rosé-gold rose-gold	[.022]
E gold matt gold matt	[.021]	L rosé-gold matt rose-gold matt	[.023]

-12 schwarz black	mit Aufpreis / with surcharge	
-21 weiß white	-51 Weißer Türkis White turquoise	-55 Labradorit Labradorite
	-52 Schwarzer Marmor Black Marble	-56 blauer Avanturin blue Aventurine
	-53 Amethyst Amethyst	
	-54 Malachit Malachite	

Unterputz-Umstellung und Ventile | Diverter and valves concealed





	638.40.650	Unterputz 3-Wege Umstellung 1/2" Fertigmontageset	Concealed 3-position diverter 1/2" assembly set	A	B	C	D	E
		<ul style="list-style-type: none"> Griff Hülse, Schubrosette 	<ul style="list-style-type: none"> design handle socket with adjustable escutcheon 	279,-	324,-	339,-	349,-	436,-
				F	G	H	I	L

Benötigt | Required

	649.40.600	Unterputz 3-Wege Umstellung 1/2" Einbaukörper	Concealed 3-position diverter 1/2" diverter body	A				
		<ul style="list-style-type: none"> zu Fertigmontageset 638.40.650 	<ul style="list-style-type: none"> for assembly set 638.40.650 	236,-				

	638.50.234	Unterputz-Ventil Fertigmontageset	Concealed wall valve assembly set	A	B	C	D	E
		<ul style="list-style-type: none"> Griff Hülse, Schubrosette 	<ul style="list-style-type: none"> design handle socket with adjustable escutcheon 	259,-	292,-	309,-	319,-	405,-
				F	G	H	I	L

Benötigt | Required

	649.20.350	Unterputz-Ventil 1/2", Einbaukörper	Concealed wall valve 1/2", body	A				
		<ul style="list-style-type: none"> rechtsschließend, ker. Scheiben 	<ul style="list-style-type: none"> clockwise closure, ceramic discs 	66,-				
	649.20.355	Unterputz-Ventil 1/2", Einbaukörper	Concealed wall valve 1/2", body					
		<ul style="list-style-type: none"> linksschließend, ker. Scheiben 	<ul style="list-style-type: none"> counter-clockwise closure, cer. discs 					
	649.20.450	Unterputz-Ventil 3/4", Einbaukörper	Concealed wall valve 3/4", body	A				
		<ul style="list-style-type: none"> rechtsschließend, ker. Scheiben 	<ul style="list-style-type: none"> clockwise closure, ceramic discs 	99,-				
	649.20.455	Unterputz-Ventil 3/4", Einbaukörper	Concealed wall valve 3/4", body					
		<ul style="list-style-type: none"> linksschließend, ker. Scheiben 	<ul style="list-style-type: none"> counter-clockwise closure, cer. discs 					

Brausen | Showers

	638.13.305	Duschgarnitur, komplett	Shower bar set, complete	A	B	C	D	E
		<ul style="list-style-type: none"> Wandrohr 800 mm, mit Schieber Metall-Handbrause mit Anti-Kalk-System und Rückflussverhinderer Metall-Brauseschlauch 1750 mm, beidseitig mit drehbarem Konus 	<ul style="list-style-type: none"> wall bar 800 mm, with slider metal hand shower with anticalc. system and backflow preventer metal shower hose 1750 mm, both sides with turning cone 	692,-	1.152,-	1.334,-	1.478,-	1.929,-
				F	G	H	I	L

	638.13.350	Duschstange, lose	Shower bar, separate	A	B	C	D	E
		<ul style="list-style-type: none"> Wandrohr 800 mm, mit Schieber 	<ul style="list-style-type: none"> wall bar 800 mm, with slider 	536,-	748,-	864,-	949,-	1.220,-
				F	G	H	I	L

	638.13.300	Duschgarnitur, komplett	Shower bar set, complete	A	B	C	D	E
		<ul style="list-style-type: none"> Wandrohr 800 mm, mit Schieber Metall-Handbrause mit Anti-Kalk-System und Rückflussverhinderer Metall-Brauseschlauch 1750 mm, beidseitig mit drehbarem Konus 	<ul style="list-style-type: none"> wall bar 800 mm, with slider metal hand shower with anticalc. system and backflow preventer metal shower hose 1750 mm, both sides with turning cone 	597,-	912,-	1.096,-	1.239,-	1.665,-
				F	G	H	I	L

VALENCIA

Maßzeichnungen unter www.joerger.de - Menü SERVICE.
 Technical specifications under www.joerger.de - menu SERVICE.

A chrom chrome	[.000]	E platin matt platinum matt	[.066]
B silbernickel polished nickel	[.035]	F nerz matt milk matt	[.096]
C nerz milk	[.095]	G schwarz-matt black matt	[.092]
C nickel matt satin nickel	[.036]	G weiß-matt white matt	[.052]
D edelmessing sunshine	[.040]	H bronze bronze	[.011]
D platin platinum	[.065]	I gold gold	[.020]
E edelmess.matt sunshine matt	[.041]	L rosé-gold rose-gold	[.022]
E gold matt gold matt	[.021]	L rosé-gold matt rose-gold matt	[.023]

-12 schwarz black	mit Aufpreis / with surcharge	-55 Labradorit Labradorite
-21 weiß white	-51 Weißer Türkis White turquoise	-56 blauer Avanturin blue Aventurine
	-52 Schwarzer Marmor Black Marble	
	-53 Amethyst Amethyst	
	-54 Malachit Malachite	

	638.13.215 Schlauchbrausegarnitur	Shower combination	A	B	C	D	E
	<ul style="list-style-type: none"> Wandanschlußbogen ½" mit Brausehalter, Schubrosette Metall-Handbrause mit Anti-Kalk-System und Rückflussverhinderer Metall-Brauseschlauch 1500 mm 	<ul style="list-style-type: none"> wall elbow connection ½" and fitting for hand shower metal hand shower with anticalc. system and backflow preventer flexible metal shower hose 1500 mm 	425,-	634,-	749,-	814,-	989,-
			F	G	H	I	L
			899,-	819,-	1.254,-	1.344,-	1.724,-

	638.13.210 Schlauchbrausegarnitur	Shower combination	A	B	C	D	E
	<ul style="list-style-type: none"> Wandanschlußbogen ½" mit Brausehalter, Schubrosette Metall-Handbrause mit Anti-Kalk-System und Rückflussverhinderer Metall-Brauseschlauch 1500 mm 	<ul style="list-style-type: none"> wall elbow connection ½" and fitting for hand shower metal hand shower with anticalc. system and backflow preventer flexible metal shower hose 1500 mm 	348,-	498,-	635,-	698,-	864,-
			F	G	H	I	L
			774,-	694,-	1.128,-	1.218,-	1.598,-

	638.13.150 Wandanschlußbogen ½", ohne Haken	Wall elbow connection ½", without cradle	A	B	C	D	E
	<ul style="list-style-type: none"> Brauseabgang ½" mit Rückflussverhinderer, Rosette 	<ul style="list-style-type: none"> discharge ½" with backflow preventer, escutcheon 	87,-	136,-	179,-	199,-	249,-
			F	G	H	I	L
			228,-	179,-	226,-	284,-	389,-

	649.13.250 Wand-Brausehalter	Wall fitting for hand shower	A	B	C	D	E
			189,-	208,-	229,-	249,-	294,-
			F	G	H	I	L
			278,-	229,-	287,-	336,-	479,-

	638.13.237 Hygienebrausegarnitur	Ablution spray combination	A	B	C	D	E
	<ul style="list-style-type: none"> Wandbrausehalter und -anschlußbogen ½", Schubrosette Hygienebrause, modern (649.13.337), komplett aus Metall einstrahlig, Bedienung über Druckhebel Metall-Brauseschlauch 1250 mm 	<ul style="list-style-type: none"> wall fitting and elbow connection ½" spray handshower, modern (649.13.337), completely metal one jet, push-lever operation flexible metal shower hose 1250 mm 	279,-	449,-	586,-	619,-	835,-
			F	G	H	I	L
			744,-	664,-	1.099,-	1.189,-	1.569,-

VALENCIA

Maßzeichnungen unter www.joerger.de - Menü SERVICE.
 Technical specifications under www.joerger.de - menu SERVICE.

A chrom chrome	[.000]	E platin matt platinum matt	[.066]
B silbernickel polished nickel	[.035]	F nerz matt milk matt	[.096]
C nerz milk	[.095]	G schwarz-matt black matt	[.092]
C nickel matt satin nickel	[.036]	G weiß-matt white matt	[.052]
D edelmessing sunshine	[.040]	H bronze bronze	[.011]
D platin platinum	[.065]	I gold gold	[.020]
E edelmess.matt sunshine matt	[.041]	L rosé-gold rose-gold	[.022]
E gold matt gold matt	[.021]	L rosé-gold matt rose-gold matt	[.023]

-12 schwarz black	mit Aufpreis / with surcharge	-55 Labradorit Labradorite
-21 weiß white	-51 Weißer Türkis White turquoise	-56 blauer Avanturin blue Aventurine
	-52 Schwarzer Marmor Black Marble	
	-53 Amethyst Amethyst	
	-54 Malachit Malachite	

	638.20.237 1-Hand Batterie 1/2" für Hygiene-Brause, Fertigmontageset	Concealed single lever 1/2" for ablution spray, assembly set	A	B	C	D	E
	<ul style="list-style-type: none"> ■ Rosette, Griff 	<ul style="list-style-type: none"> ■ escutcheon, handle 	349,-	459,-	520,-	588,-	687,-
	Benötigt Required		F	G	H	I	L

	649.20.237 Unterputz 1-Hand Batterie 1/2", Einbaukörper	Single lever mixer 1/2", concealed body	A	B	C	D	E
	<ul style="list-style-type: none"> ■ Kartusche mit keramischen Scheiben ■ zu Fertigmontageset 638.20.237 	<ul style="list-style-type: none"> ■ cartridge with ceramic discs ■ for assembly set 638.20.237 	125,-	169,-	208,-	229,-	268,-
			F	G	H	I	L

	649.13.845 Regenbrause 1/2", ø 300 mm	Rain shower head 1/2", ø 300 mm	A	B	C	D	E
	<ul style="list-style-type: none"> ■ Ausführung ganz in Metall ■ 3 mm ultra flach ■ mit Kugelgelenk ■ Anti-Kalk-System 	<ul style="list-style-type: none"> ■ full metal body ■ 3 mm ultra-thin ■ with ball joint ■ with anticalcareous system 	687,-	1.329,-	1.562,-	1.669,-	1.998,-
	<ul style="list-style-type: none"> ■ weitere, zur Serie passende Kopfbrausen siehe Kapitel "Brausen" 	<ul style="list-style-type: none"> ■ for further shower heads matching this collection see chapter "showers" 	F	G	H	I	L

	649.13.755 Wandarm 1/2"	Wall bracket 1/2"	A	B	C	D	E
	<ul style="list-style-type: none"> ■ Ausladung 350 mm 	<ul style="list-style-type: none"> ■ projection 350 mm 	129,-	288,-	316,-	349,-	439,-
	<ul style="list-style-type: none"> ■ weitere, zur Serie passende Wandarme siehe Kapitel "Brausen" 	<ul style="list-style-type: none"> ■ for further wall brackets matching this collection see chapter "showers" 	F	G	H	I	L

	649.13.519 Seitenbrause 1/2"	Body spray side shower 1/2"	A	B	C	D	E
	<ul style="list-style-type: none"> ■ Rosette ø 130 mm, Wandmontage ■ Brausekopf schwenkbar, 20° ■ Anti-Kalk-System ■ Material: Kunststoff 	<ul style="list-style-type: none"> ■ escutcheon ø 130 mm, wall assembly ■ swivel shower head, 20° ■ anticalcareous system ■ plastic 	167,-	326,-	385,-	399,-	542,-
	<ul style="list-style-type: none"> ■ weitere, zur Serie passende Seitenbrausen siehe Kapitel "Brausen" 	<ul style="list-style-type: none"> ■ for further side showers matching this collection see chapter "showers" 	F	G	H	I	L

	649.13.395 Handbrause 1/2"	Hand shower 1/2"	A	B	C	D	E
	<ul style="list-style-type: none"> ■ Anti-Kalk-System ■ 3 Strahlarten: Normal, Massage, Soft ■ Anschluss 1/2" 	<ul style="list-style-type: none"> ■ anticalcareous system ■ with 3 jets: normal, hydromassage, soft ■ connection 1/2" 	165,-	239,-	299,-	349,-	509,-
	<ul style="list-style-type: none"> ■ weitere, zur Serie passende Handbrausen siehe Kapitel "Brausen" 	<ul style="list-style-type: none"> ■ for further hand showers matching this collection see chapter "showers" 	F	G	H	I	L







	649.13.391 Handbrause 1/2"	Hand shower 1/2"	A	B	C	D	E
	<ul style="list-style-type: none"> ■ Anti-Kalk-System ■ Anschluss 1/2" ■ Ausführung Metall 	<ul style="list-style-type: none"> ■ anticalcareous system ■ connection 1/2" ■ material metal 	208,-	398,-	426,-	464,-	578,-
	<ul style="list-style-type: none"> ■ weitere, zur Serie passende Handbrausen siehe Kapitel "Brausen" 	<ul style="list-style-type: none"> ■ for further hand showers matching this collection see chapter "showers" 	F	G	H	I	L

VALENCIA

Maßzeichnungen unter www.joerger.de - Menü SERVICE.
 Technical specifications under www.joerger.de - menu SERVICE.

A chrom chrome	[.000]	E platin matt platinum matt	[.066]
B silbernickel polished nickel	[.035]	F nerz matt milk matt	[.096]
C nerz milk	[.095]	G schwarz-matt black matt	[.092]
C nickel matt satin nickel	[.036]	G weiß-matt white matt	[.052]
D edelmessing sunshine	[.040]	H bronze bronze	[.011]
D platin platinum	[.065]	I gold gold	[.020]
E edelmess.matt sunshine matt	[.041]	L rosé-gold rose-gold	[.022]
E gold matt gold matt	[.021]	L rosé-gold matt rose-gold matt	[.023]

Accessoires für Handtücher | Accessories for towels

		A	B	C	D	E				
	638.00.002 Handtuchhalter ■ starres Rohr, ca. 440 mm	Single towel bar ■ rigid bar, approx. 440 mm		179,-	242,-	305,-	332,-	428,-		
		F	G	H	I	L	389,-	299,-	354,-	498,-
	638.00.023 Handtuchhaken, einfach	Robe hanger		147,-	198,-	238,-	254,-	314,-		
		F	G	H	I	L	289,-	240,-	305,-	362,-
	638.00.040 Badetuchhalter ■ ca. 790 mm	Bath towel bar ■ approx. 790 mm		279,-	428,-	599,-	672,-	938,-		
		F	G	H	I	L	832,-	495,-	772,-	1.059,-
	638.00.031 Wannengriff ■ ca. 290 mm	Tub handle ■ approx. 290 mm		252,-	434,-	562,-	615,-	812,-		
		F	G	H	I	L	734,-	518,-	648,-	896,-
	638.00.030 Duschtürgriff ■ ca. 550 mm	Shower door handle ■ approx. 550 mm		596,-	918,-	1.149,-	1.246,-	1.599,-		
		F	G	H	I	L	1.459,-	1.109,-	1.388,-	1.799,-
	634.00.104 Gästehandtuchkorb, eckig ■ mit Ablage ■ Korbgröße 260 x 150 x 190 mm	Guest towel basket, angular ■ with shelf ■ basket size 260 x 150 x 190 mm		230,-	314,-	356,-	389,-	528,-		
		F	G	H	I	L	466,-	492,-	675,-	849,-









Accessoires für Waschplatz | Accessories for washstands

		A	B	C	D	E				
	638.00.007 Seifenhalter, komplett ■ Seifenschale aus Kristallglas, seidenmatt	Soap dish holder, complete ■ crystal glass dish, frosted		246,-	354,-	376,-	398,-	496,-		
		F	G	H	I	L	454,-	364,-	434,-	549,-
737.00.307 Seifenschale, lose	Glass dish, separate	A					90,-			

VALENCIA

Maßzeichnungen unter www.joerger.de - Menü SERVICE.
 Technical specifications under www.joerger.de - menu SERVICE.

A chrom chrome	[.000]	E platin matt platinum matt	[.066]
B silbernickel polished nickel	[.035]	F nerz matt milk matt	[.096]
C nerz milk	[.095]	G schwarz-matt black matt	[.092]
C nickel matt satin nickel	[.036]	G weiß-matt white matt	[.052]
D edelmessing sunshine	[.040]	H bronze bronze	[.011]
D platin platinum	[.065]	I gold gold	[.020]
E edelmess.matt sunshine matt	[.041]	L rosé-gold rose-gold	[.022]
E gold matt gold matt	[.021]	L rosé-gold matt rose-gold matt	[.023]

	638.00.017 Seifenhalter, komplett ■ Standmodell ■ Seifenschale aus Kristallglas, seidenmatt	Soap dish holder, complete ■ free standing version ■ crystal glass dish, frosted	A	B	C	D	E
			154,-	198,-	214,-	242,-	287,-
			F	G	H	I	L
275,-	258,-	308,-	359,-	438,-			
	634.00.105 Schwammkorb ■ rechteckig, 260 x 130 mm	Sponge basket ■ rectangular, 260 x 130 mm	A	B	C	D	E
			199,-	238,-	279,-	332,-	462,-
			F	G	H	I	L
396,-	348,-	459,-	589,-	859,-			
	634.00.106 Eckschwammkorb ■ 195 x 195 mm	Corner sponge basket ■ 195 x 195 mm	A	B	C	D	E
			195,-	234,-	275,-	328,-	458,-
			F	G	H	I	L
390,-	344,-	455,-	585,-	855,-			
	638.00.006 Lotionsspender, komplett ■ Glas aus Kristallglas, seidenmatt	Soap dispenser, complete ■ crystal glass, frosted	A	B	C	D	E
			299,-	406,-	428,-	449,-	548,-
			F	G	H	I	L
506,-	416,-	486,-	598,-	818,-			
	737.00.306 Lotionsspenderglas, lose ■ seidenmatt, ohne Pumpe	Soap dispenser glass, separate ■ frosted, without pump	A				
			96,-				
	638.00.016 Lotionsspender, komplett ■ Standmodell ■ Glas aus Kristallglas, seidenmatt	Soap dispenser, complete ■ free standing version ■ crystal glass, frosted	A	B	C	D	E
			179,-	276,-	298,-	338,-	399,-
			F	G	H	I	L
383,-	292,-	379,-	498,-	709,-			
	638.00.036 Glashalter, komplett ■ Glas aus Kristallglas, seidenmatt	Tumbler holder, complete ■ crystal glass tumbler, frosted	A	B	C	D	E
			254,-	362,-	384,-	406,-	504,-
			F	G	H	I	L
462,-	372,-	442,-	556,-	638,-			
	737.00.336 Mundglas, lose	Glass tumbler, separate	A				
			92,-				
	638.00.046 Glashalter, komplett ■ Standmodell ■ Glas aus Kristallglas, seidenmatt	Tumbler holder, complete ■ free standing version ■ crystal glass tumbler, frosted	A	B	C	D	E
			159,-	204,-	219,-	248,-	292,-
			F	G	H	I	L
279,-	264,-	314,-	364,-	444,-			

VALENCIA

Maßzeichnungen unter www.joerger.de - Menü SERVICE.
 Technical specifications under www.joerger.de - menu SERVICE.

A chrom chrome	[.000]	E platin matt platinum matt	[.066]
B silbernickel polished nickel	[.035]	F nerz matt milk matt	[.096]
C nerz milk	[.095]	G schwarz-matt black matt	[.092]
C nickel matt satin nickel	[.036]	G weiß-matt white matt	[.052]
D edelmessing sunshine	[.040]	H bronze bronze	[.011]
D platin platinum	[.065]	I gold gold	[.020]
E edelmess.matt sunshine matt	[.041]	L rosé-gold rose-gold	[.022]
E gold matt gold matt	[.021]	L rosé-gold matt rose-gold matt	[.023]

Accessoires für WC-Bereich | Accessories for w.c. area

	638.00.014 Papierhalter ■ mit Deckel	Toilet paper roll holder ■ with lid	A	B	C	D	E
			209,-	274,-	349,-	379,-	496,-
			F	G	H	I	L
			449,-	416,-	599,-	645,-	1.086,-

	638.00.015 Reserve-Papierhalter	Spare toilet paper roll holder	A	B	C	D	E
			167,-	258,-	324,-	352,-	454,-
			F	G	H	I	L
			414,-	297,-	429,-	498,-	649,-

	638.00.000 Klosettbürstengarnitur, komplett ■ Glas aus Kristallglas, seidenmatt	Toilet brush holder set, complete ■ crystal glass, frosted	A	B	C	D	E
			345,-	414,-	532,-	579,-	759,-
			F	G	H	I	L
			688,-	489,-	669,-	838,-	1.019,-

	799.00.301 Bürstenglas, seidenmatt, lose	Brush glass, frosted, separate	A				
			29,-				
			F	G	H	I	L

	688.00.053 Bürstenstange komplett, lose	Brush rod with brush, separate	A	B	C	D	E
			178,-	189,-	214,-	236,-	282,-
			F	G	H	I	L
			255,-	199,-	248,-	319,-	396,-

	799.00.224 Bürstenkopf, lose	Brush, separate	A				
			19,-				
			F	G	H	I	L

	638.00.001 Klosettbürstengarnitur, komplett ■ stehendes Modell ■ Bürstentopf aus Metall	Toilet brush holder set, complete ■ floor standing model ■ brush holder out of brass	A	B	C	D	E
			298,-	366,-	419,-	479,-	608,-
			F	G	H	I	L
			539,-	536,-	776,-	984,-	1.379,-

Spiegel | Mirrors

	649.00.414 Kosmetikspiegel, beleuchtet ■ schwenk- und ausziehbar ■ 3-fache Vergrößerung ■ Direktanschluss ■ Spiegeldurchmesser 185 mm ■ Rahmendurchmesser 250 mm ■ Kalt und Warmlicht durch Piezzo-Schalter umschaltbar	Cosmetic mirror, incl. lighting ■ swivelling and extendable ■ magnification 3:1 ■ direct connection ■ mirror diameter 185 mm ■ frame diameter 250 mm ■ cold and warm light switchable by Piezzo switch	A	B	C	D	E
			556,-	988,-	1.214,-	1.418,-	1.828,-
			F	G	H	I	L
			1.684,-	1.214,-	1.549,-	2.138,-	2.998,-





Oberflächen | colours

Folgende Oberflächen sind bei dieser Serie möglich |
The following colours are possible with this collection

chrom	chrome	[.000]	PG A
silbernickel	polished nickel	[.035]	PG B
nerz	mink	[.095]	PG C
nickel matt	satin nickel	[.036]	PG C
edelmessing	sunshine	[.040]	PG D
platin	platinum	[.065]	PG D
edelmessing matt	sunshine matt	[.041]	PG E
gold matt	gold matt	[.021]	PG E
platin matt	platinum matt	[.066]	PG E
nerz matt	mink matt	[.096]	PG F
schwarz matt	black matt	[.092]	PG G
weiß matt	white matt	[.052]	PG G
bronze	bronze	[.011]	PG H
gold	gold	[.020]	PG I
roségold	rosegold	[.022]	PG L
roségold matt	rosegold matt	[.023]	PG L

Andere Oberflächen auf Anfrage |
Different colours on request

Auf Anfrage können wir Produkte von Drittanbietern auch gerne passend zu unseren Oberflächen veredeln (vorbehaltlich der Eignungsprüfung) | Third-party products may be plated matching to our colours on request (subject to valuation of suitability)

Waschtisch | Washbasin

ab Seite | from page 133

Bidet | Bidet

ab Seite | from page 133

Wanne | Bath tub

ab Seite | from page 134

Dusche | Shower

ab Seite | from page 137

Accessoires | Accessories

ab Seite | from page 146

BELLEDOR

Bei der Serie Belledor können Sie aus unterschiedlichen Porzellangriffen wählen. Die Artikelnummer wird dabei um weitere zwei Ziffern erweitert.

Beispiel: Waschtisch 3-Loch Batterie in chrom mit Porzellangriffen in weiß:

631.30.300.000-31

Modell Oberfläche Porzellangriff

With the Belledor collection you can choose from different porcelain handles. The article number then needs to be added by two additional figures.

Example: washbasin 3-hole mixer in chrome with porcelain handles in white:

631.30.300.000-31

model surface porcelain handle

MÖGLICHE PORZELLANGRIFFE | POSSIBLE PORCELAIN HANDLES



(-31) weiß
white



(-32) weiß/gold
white/gold



(-33) weiß/platin
white/platinum



(-35) schwarz
black



(-36) schwarz/gold
black/gold



(-37) schwarz/platin
black/platinum



(-41) perlmutter
mother of pearl



(-43) platin
platinum



(-42) gold
gold



(-44) coelin
cerulean

A chrom chrome	[.000]	E platin matt platinum matt	[.066]
B silbernickel polished nickel	[.035]	F nerz matt mink matt	[.096]
C nerz mink	[.095]	G schwarz-matt black matt	[.092]
C nickel matt satin nickel	[.036]	G weiß-matt white matt	[.052]
D edelmessing sunshine	[.040]	H bronze bronze	[.011]
D platin platinum	[.065]	I gold gold	[.020]
E edelmess.matt sunshine matt	[.041]	L roségold rosegold	[.022]
E gold matt gold matt	[.021]	L roségold matt rosegold matt	[.023]

-31 weiß | white
 -35 schwarz | black

mit Aufpreis / with surcharge
 -32 weiß/gold | white/gold
 -33 weiß/platin | white/platinum
 -36 schwarz/gold | black/gold
 -36 schwarz/platin | black/platinum

mit Aufpreis / with surcharge
 -41 perlmutt | mother of pearl
 -42 gold | gold
 -43 platin | platinum
 -44 kobaltblau | cobalt blue

Waschtisch Batterien | Washbasin mixer



631.30.300 Waschtisch 3-Loch Batterie 1/2"
 ■ mit Porzellangriffen
 ■ Ausladung 145 mm; Höhe 215 mm
 ■ 2 Seitenrandventile mit keramischen Oberteilen 1/2"
 ■ Ablaufventil mit Klickverschluss 1 1/4"
 ■ empfohlen:
 2x 649.15.530 - Kupferrohr 300 mm

Washbasin 3-hole mixer 1/2"
 ■ with porcelain handles
 ■ spout projection 145 mm; height 215 mm
 ■ 2 side valves with ceramic internal upper parts 1/2"
 ■ push-open waste 1 1/4"
 ■ recommended:
 2x 649.15.530 - copper tube 300 mm

A	B	C	D	E
1.314,-	1.479,-	1.759,-	1.846,-	2.328,-
F	G	H	I	L
2.164,-	1.759,-	1.932,-	2.549,-	2.936,-

Aufpreis für Applikation Surcharge for application 450,-



631.10.300 Waschtisch 1-Loch Batterie 1/2"
 ■ mit Porzellangriffen
 ■ Ausladung 105 mm; Höhe 145 mm
 ■ Exzenter-Ablaufgarnitur 1 1/4"
 ■ 2 Kupferrohre M10x1 x 400 mm

Washbasin 1-hole mixer 1/2"
 ■ with porcelain handles
 ■ spout projection 105 mm; height 145 mm
 ■ pop-up waste 1 1/4"
 ■ 2 copper tubes M10x1 x 400 mm

A	B	C	D	E
1.094,-	1.224,-	1.329,-	1.384,-	1.843,-
F	G	H	I	L
1.614,-	1.420,-	1.618,-	2.055,-	2.814,-

Aufpreis für Applikation Surcharge for application 450,-



631.30.360 Wand-Waschtisch 3-Loch Batterie 1/2", Fertigmontageset
 ■ mit Porzellangriffen
 ■ Wand-Auslauf, Ausladung 210 mm
 ■ Griff, Hülse, Schubrosette
 ■ Oberteile 1/2", keramische Scheiben

Wall washbasin 3-hole mixer 1/2" assembly set
 ■ with porcelain handles
 ■ wall spout, projection 210 mm
 ■ design handle, socket with adjustable escutcheon
 ■ cartridges 1/2", with ceramic discs

A	B	C	D	E
1.064,-	1.269,-	1.499,-	1.579,-	1.989,-
F	G	H	I	L
1.754,-	1.499,-	1.652,-	2.178,-	2.786,-

Aufpreis für Applikation Surcharge for application 450,-

Benötigt | Required



649.30.380 Wand-Waschtisch 3-Loch Batterie 1/2", Einbaukörper
 ■ 2 Anschlüsse, Stichmaß 204 mm
 ■ zu Fertigmontageset 631.30.360

Wall washbasin 3-hole mixer 1/2" concealed body
 ■ 2 connections, center distance 204 mm
 ■ for assembly set 631.30.360

A	B	C	D	E
296,-				

Bidet Batterie | Bidet mixer



631.10.100 Bidet 1-Loch Batterie 1/2"
 ■ mit Porzellangriffen
 ■ Ausladung 75 mm; Höhe 95 mm
 ■ Keramik-Innenoberteile 1/2"
 ■ Exzenter-Ablaufgarnitur 1 1/4"
 ■ 2 Kupferrohre M10x1 x 400 mm

Bidet 1-hole mixer 1/2"
 ■ with porcelain handles
 ■ spout projection 75 mm; height 95 mm
 ■ ceramic internal upper parts 1/2"
 ■ pop-up waste 1 1/4"
 ■ 2 copper tubes M10x1 x 400 mm

A	B	C	D	E
978,-	1.099,-	1.196,-	1.246,-	1.659,-
F	G	H	I	L
1.452,-	1.278,-	1.489,-	1.850,-	2.638,-

Aufpreis für Applikation Surcharge for application 450,-

Maßzeichnungen unter www.joerger.de - Menü SERVICE.
 Technical specifications under www.joerger.de - menu SERVICE.

A chrom chrome	[.000]	E platin matt platinum matt	[.066]
B silbernickel polished nickel	[.035]	F nerz matt mink matt	[.096]
C nerz mink	[.095]	G schwarz-matt black matt	[.092]
C nickel matt satin nickel	[.036]	G weiß-matt white matt	[.052]
D edelmessing sunshine	[.040]	H bronze bronze	[.011]
D platin platinum	[.065]	I gold gold	[.020]
E edelmess.matt sunshine matt	[.041]	L roségold rosegold	[.022]
E gold matt gold matt	[.021]	L roségold matt rosegold matt	[.023]

-31 weiß white	mit Aufpreis / with surcharge	mit Aufpreis / with surcharge
-35 schwarz black	-32 weiß/gold white/gold	-41 perlmutt mother of pearl
	-33 weiß/platin white/platinum	-42 gold gold
	-36 schwarz/gold black/gold	-43 platin platinum
	-36 schwarz/platin black/platinum	-44 kobaltblau cobalt blue

Zubehör für Waschtisch- und Bidet-Batterien | Supplies for washbasin and bidet mixer

	631.12.100 Eckventil 1/2"	Angle valve 1/2"	A	B	C	D	E
	<ul style="list-style-type: none"> mit Porzellangriff Ausladung 135 mm Fettkammer-Innenoberteil 1/2" Quetschverschraubung Schubrosette 	<ul style="list-style-type: none"> with porcelain handle projection 135 mm cartridge 1/2" compression joint escutcheon 	459,-	489,-	529,-	536,-	564,-
	Aufpreis für Applikation		Surcharge for application	225,-			

	649.15.530 Kupferrohr, 300 mm	Copper tube, 300 mm	A	B	C	D	E
	<ul style="list-style-type: none"> mit Bördel, für Quetschverschraubung 	<ul style="list-style-type: none"> with flange, for compression joint 	15,-	38,-	55,-	62,-	74,-
	Aufpreis für Applikation		Surcharge for application	225,-			

Variante | Alternative

	649.15.550 Kupferrohr, 500 mm	Copper tube, 500 mm	A	B	C	D	E
	<ul style="list-style-type: none"> mit Bördel, für Quetschverschraubung 	<ul style="list-style-type: none"> with flange, for compression joint 	20,-	58,-	77,-	87,-	102,-
	Aufpreis für Applikation		Surcharge for application	225,-			

	649.15.340 Waschtisch-Tassensiphon 1 1/4"	Washbasin cupped siphon trap 1 1/4"	A	B	C	D	E
	<ul style="list-style-type: none"> schwere Ausführung Rosette Abgangsrohr ø 32 mm Tauchrohrlänge 165 mm 	<ul style="list-style-type: none"> heavy brass escutcheon outlet tube ø 32 mm dip pipe 165 mm 	195,-	296,-	368,-	429,-	568,-
	Aufpreis für Applikation		Surcharge for application	225,-			

	649.15.330 Bidet-Tassensiphon 1 1/4"	Bidet cupped siphon trap 1 1/4"	A	B	C	D	E
	<ul style="list-style-type: none"> Rosette Abgangsrohr ø 32 mm 	<ul style="list-style-type: none"> escutcheon outlet tube ø 32 mm 	98,-	166,-	276,-	332,-	472,-
	Aufpreis für Applikation		Surcharge for application	225,-			

Badewanne, Stand-Batterien | Bath tub mixer sets, deck mount

	631.40.100 4-Loch Wannenfüll- u. Brausebatterie 1/2", Standmontage	Tub/shower mixer set 1/2" deck mount	A	B	C	D	E
	<ul style="list-style-type: none"> mit Porzellangriffen Ausladung 215 mm; Höhe 260 mm automatische Umstellung Wanne/Brause 2 Seitenrandventile mit keramischen Oberteilen 1/2" Metall-Brauseschlauch 2000 mm Metall-Handbrause mit Anti-Kalk-System und Rückflussverhinderer Montageplatte 649.40.160.000 wird empfohlen 	<ul style="list-style-type: none"> with porcelain handles spout projection 215 mm; height 260 mm automatic diverter tub/shower 2 side valves, ceramic internal upper parts 1/2" metal shower hose 2000 mm metal hand shower with anticalc. system and backflow preventer Assembly plate 649.40.160.000 recommended 	1.986,-	2.379,-	2.528,-	2.676,-	3.282,-
	Aufpreis für Applikation		Surcharge for application	450,-			

A chrom chrome	[.000]	E platin matt platinum matt	[.066]
B silbernickel polished nickel	[.035]	F nerz matt mink matt	[.096]
C nerz mink	[.095]	G schwarz-matt black matt	[.092]
C nickel matt satin nickel	[.036]	G weiß-matt white matt	[.052]
D edelmessing sunshine	[.040]	H bronze bronze	[.011]
D platin platinum	[.065]	I gold gold	[.020]
E edelmess.matt sunshine matt	[.041]	L roségold rosegold	[.022]
E gold matt gold matt	[.021]	L roségold matt rosegold matt	[.023]

-31 weiß | white
 -35 schwarz | black

mit Aufpreis / with surcharge
 -32 weiß/gold | white/gold
 -33 weiß/platin | white/platinum
 -36 schwarz/gold | black/gold
 -36 schwarz/platin | black/platinum

mit Aufpreis / with surcharge
 -41 perlmutt | mother of pearl
 -42 gold | gold
 -43 platin | platinum
 -44 kobaltblau | cobalt blue

631.40.105 4-Loch Wannenfüll- u. Brause-
 batterie 1/2", Standmontage

- mit Porzellangriffen
- Ausladung 215 mm; Höhe 260 mm
- automatische Umstellung Wanne/Brause
- 2 Seitenrandventile mit keramischen Oberteilen 1/2"
- Metall-Brauseschlauch 2000 mm
- Metall-Handbrause mit Anti-Kalk-System und Rückflussverhinderer
- Montageplatte 649.40.160.000 wird empfohlen



Tub/shower mixer set 1/2"
 deck mount

- with porcelain handles
- spout projection 215 mm; height 260 mm
- automatic diverter tub/shower
- 2 side valves, ceramic internal upper parts 1/2"
- metal shower hose 2000 mm
- metal hand shower with anticalc. system and backflow preventer
- Assembly plate 649.40.160.000 recommended

A	B	C	D	E
2.098,-	2.565,-	2.756,-	2.886,-	3.626,-
F	G	H	I	L
3.304,-	2.426,-	3.084,-	3.969,-	4.968,-

Aufpreis für Applikation Surcharge for application 450,-

631.40.150 4-Loch Wannenrandkombi 1/2"

- mit Porzellangriffen
- für Ab- und Überlaufgarnitur mit Wanneneinlauf, ohne Rohrunterbrecher
- Seitenrandventile, 2-Wege Umstellung
- Metall-Brauseschlauch 2000 mm



Tub/shower combination 1/2"

- with porcelain handles
- for waste and overflow set with bath tub filler spout, without pipe interrupter
- side valves, 2-position diverter
- metal shower hose 2000 mm

A	B	C	D	E
1.668,-	1.816,-	2.035,-	2.185,-	2.414,-
F	G	H	I	L
2.352,-	2.099,-	2.632,-	2.814,-	3.765,-

Aufpreis für Applikation Surcharge for application 675,-

631.40.155 4-Loch Wannenrandkombi 1/2"

- mit Porzellangriffen
- für Ab- und Überlaufgarnitur mit Wanneneinlauf, ohne Rohrunterbrecher
- Seitenrandventile, 2-Wege Umstellung
- Metall-Brauseschlauch 2000 mm



Tub/shower combination 1/2"

- with porcelain handles
- for waste and overflow set with bath tub filler spout, without pipe interrupter
- side valves, 2-position diverter
- metal shower hose 2000 mm

A	B	C	D	E
1.762,-	1.982,-	2.249,-	2.334,-	2.572,-
F	G	H	I	L
2.499,-	2.172,-	2.792,-	2.996,-	3.925,-

Aufpreis für Applikation Surcharge for application 675,-

Empfohlen | Recommended

649.40.160 Montageplatte, komplett

- für 4-Loch Armaturen
- Druckschläuche 1/2" x 1/2" x 600 mm
- empfohlen: Schlauchkastensystem siehe Kapitel "Serienübergreifendes"



Assembly plate, complete

- for deck mounted tub/shower mixer
- pressure hoses 1/2" x 1/2" x 600 mm
- recommended: system with hose box see chapter "universal products"

A	B	C	D	E
308,-				

Badewanne, Aufputz-Batterien | Bath tub mixer sets, exposed

631.20.100 Aufputz Wannenfüll- und Brausebatterie 1/2", mit Garnitur

- mit Porzellangriffen
- Ausladung ca. 295 mm
- Metall-Handbrause mit Anti-Kalk-System und Rückflussverhinderer
- Metall-Brauseschlauch 1500 mm



Exposed tub/shower mixer 1/2", incl. shower set

- with porcelain handles
- spout projection approx. 295 mm
- metal hand shower with anticalc. system and backflow preventer
- metal shower hose 1500 mm

A	B	C	D	E
1.892,-	2.349,-	2.798,-	2.988,-	4.388,-
F	G	H	I	L
3.958,-	2.836,-	4.172,-	4.458,-	5.668,-

Aufpreis für Applikation Surcharge for application 450,-

Maßzeichnungen unter www.joerger.de - Menü SERVICE.
 Technical specifications under www.joerger.de - menu SERVICE.

A chrom chrome	[.000]	E platin matt platinum matt	[.066]
B silbernickel polished nickel	[.035]	F nerz matt milk matt	[.096]
C nerz milk	[.095]	G schwarz-matt black matt	[.092]
C nickel matt satin nickel	[.036]	G weiß-matt white matt	[.052]
D edelmessing sunshine	[.040]	H bronze bronze	[.011]
D platin platinum	[.065]	I gold gold	[.020]
E edelmess.matt sunshine matt	[.041]	L roségold rosegold	[.022]
E gold matt gold matt	[.021]	L roségold matt rosegold matt	[.023]

-31 weiß white	mit Aufpreis / with surcharge	mit Aufpreis / with surcharge
-35 schwarz black	-32 weiß/gold white/gold	-41 perlmutt mother of pearl
	-33 weiß/platin white/platinum	-42 gold gold
	-36 schwarz/gold black/gold	-43 platin platinum
	-36 schwarz/platin black/platinum	-44 kobaltblau cobalt blue

	631.20.105 Aufputz Wannenfüll- und Brausebatterie ½", mit Garnitur <ul style="list-style-type: none"> mit Porzellangriffen Ausladung ca. 295 mm Metall-Handbrause mit Anti-Kalk-System und Rückflussverhinderer Metall-Brauseschlauch 1500 mm 	Exposed tub/shower mixer ½", incl. shower set <ul style="list-style-type: none"> with porcelain handles spout projection approx. 295 mm metal hand shower with anticalc. system and backflow preventer metal shower hose 1500 mm 	<table border="1"> <tr><th></th><th>B</th><th>C</th><th>D</th><th>E</th></tr> <tr><td>1.985,-</td><td>2.517,-</td><td>2.958,-</td><td>3.224,-</td><td>4.718,-</td></tr> <tr><th>F</th><th>G</th><th>H</th><th>I</th><th>L</th></tr> <tr><td>4.246,-</td><td>2.907,-</td><td>4.482,-</td><td>4.799,-</td><td>5.999,-</td></tr> </table>		B	C	D	E	1.985,-	2.517,-	2.958,-	3.224,-	4.718,-	F	G	H	I	L	4.246,-	2.907,-	4.482,-	4.799,-	5.999,-
		B	C	D	E																		
	1.985,-	2.517,-	2.958,-	3.224,-	4.718,-																		
F	G	H	I	L																			
4.246,-	2.907,-	4.482,-	4.799,-	5.999,-																			
Aufpreis für Applikation	Surcharge for application	450,-																					

	631.20.150 Wannenfüll- und Brausebatterie für Standrohrmontage, mit Garnitur <ul style="list-style-type: none"> mit Porzellangriffen für freistehende Montage Ausladung 215 mm Umstellung Wanne/Brause Metall-Handbrause mit Anti-Kalk-System und Rückflussverhinderer Metall-Brauseschlauch 1500 mm Standrohre mit Befestigungsflansch Luftsprudler Höhe gesamt 905 mm Höhe bis Luftsprudler 814 mm 	Tub/shower mixer for supply pipes, incl. shower set <ul style="list-style-type: none"> with porcelain handles free standing assembly spout projection 215 mm metal hand shower with anticalc. system and backflow preventer metal shower hose 1500 mm Pillar tube with flange aerator height 905 mm aerator height 814 mm 	<table border="1"> <tr><th>A</th><th>B</th><th>C</th><th>D</th><th>E</th></tr> <tr><td>2.685,-</td><td>3.829,-</td><td>4.454,-</td><td>4.776,-</td><td>6.358,-</td></tr> <tr><th>F</th><th>G</th><th>H</th><th>I</th><th>L</th></tr> <tr><td>5.678,-</td><td>3.968,-</td><td>6.018,-</td><td>7.078,-</td><td>8.139,-</td></tr> </table>	A	B	C	D	E	2.685,-	3.829,-	4.454,-	4.776,-	6.358,-	F	G	H	I	L	5.678,-	3.968,-	6.018,-	7.078,-	8.139,-
	A	B	C	D	E																		
	2.685,-	3.829,-	4.454,-	4.776,-	6.358,-																		
F	G	H	I	L																			
5.678,-	3.968,-	6.018,-	7.078,-	8.139,-																			
benötigt: Bausatz-Vormontage 109.10.970.000	required: assembly set for pre-installation 109.10.970.000																						
Aufpreis für Applikation	Surcharge for application	450,-																					

	631.20.155 Wannenfüll- und Brausebatterie für Standrohrmontage, mit Garnitur <ul style="list-style-type: none"> mit Porzellangriffen für freistehende Montage Ausladung 215 mm Umstellung Wanne/Brause Metall-Handbrause mit Anti-Kalk-System und Rückflussverhinderer Metall-Brauseschlauch 1500 mm Standrohre mit Befestigungsflansch Luftsprudler Höhe gesamt 905 mm Höhe bis Luftsprudler 814 mm 	Tub/shower mixer for supply pipes, incl. shower set <ul style="list-style-type: none"> with porcelain handles free standing assembly spout projection 215 mm metal hand shower with anticalc. system and backflow preventer metal shower hose 1500 mm Pillar tube with flange aerator height 905 mm aerator height 814 mm 	<table border="1"> <tr><th>A</th><th>B</th><th>C</th><th>D</th><th>E</th></tr> <tr><td>2.796,-</td><td>3.998,-</td><td>4.668,-</td><td>5.010,-</td><td>6.688,-</td></tr> <tr><th>F</th><th>G</th><th>H</th><th>I</th><th>L</th></tr> <tr><td>5.968,-</td><td>4.038,-</td><td>6.328,-</td><td>7.452,-</td><td>8.569,-</td></tr> </table>	A	B	C	D	E	2.796,-	3.998,-	4.668,-	5.010,-	6.688,-	F	G	H	I	L	5.968,-	4.038,-	6.328,-	7.452,-	8.569,-
	A	B	C	D	E																		
	2.796,-	3.998,-	4.668,-	5.010,-	6.688,-																		
F	G	H	I	L																			
5.968,-	4.038,-	6.328,-	7.452,-	8.569,-																			
benötigt: Bausatz-Vormontage 109.10.970.000	required: assembly set for pre-installation 109.10.970.000																						
Aufpreis für Applikation	Surcharge for application	450,-																					

Benötigt Required				
109.10.970 Bausatz-Vormontage	Assembly set for pre-installation	A		
<ul style="list-style-type: none"> Bodenplatte mit Befestigungsset zu Fertigmontageset 631.20.150 und 631.20.155 	<ul style="list-style-type: none"> joint plate with fixing set for assembly set 631.20.150 und 631.20.155 	459,-		

A chrom chrome	[.000]	E platin matt platinum matt	[.066]
B silbernickel polished nickel	[.035]	F nerz matt milk matt	[.096]
C nerz milk	[.095]	G schwarz-matt black matt	[.092]
C nickel matt satin nickel	[.036]	G weiß-matt white matt	[.052]
D edelmessing sunshine	[.040]	H bronze bronze	[.011]
D platin platinum	[.065]	I gold gold	[.020]
E edelmess.matt sunshine matt	[.041]	L roségold rosegold	[.022]
E gold matt gold matt	[.021]	L roségold matt rosegold matt	[.023]

-31 weiß | white
 -35 schwarz | black

mit Aufpreis / with surcharge
 -32 weiß/gold | white/gold
 -33 weiß/platin | white/platinum
 -36 schwarz/gold | black/gold
 -36 schwarz/platin | black/platinum

mit Aufpreis / with surcharge
 -41 perlmutt | mother of pearl
 -42 gold | gold
 -43 platin | platinum
 -44 kobaltblau | cobalt blue



631.11.100 Wand-Wanneneinlauf 1/2"
 ■ Ausladung 205 mm
 ■ Steckanschluß-Montage

Tub wall spout 1/2"
 ■ spout projection 205 mm
 ■ special concealed wall attachment

A	B	C	D	E
419,-	639,-	788,-	834,-	1.089,-
F	G	H	I	L
978,-	788,-	879,-	1.198,-	1.514,-

Dusche, Aufputz-Batterien | Shower mixer sets, exposed



631.20.200 Brausebatterie 1/2"
 für Aufputzmontage
 ■ mit Porzellangriffen
 ■ 2 keramische Oberteile 1/2"
 ■ Brauseabgang 1/2"
 ■ verdeckte S-Anschlüsse 1/2" x 3/4"

Exposed shower mixer 1/2"
 ■ with porcelain handles
 ■ 2 ceramic internal upper parts 1/2"
 ■ discharge 1/2"
 ■ concealed S-connections 1/2" x 3/4"

A	B	C	D	E
1.324,-	1.554,-	1.689,-	1.745,-	2.429,-
F	G	H	I	L
2.126,-	1.784,-	2.042,-	2.649,-	3.469,-

Aufpreis für Applikation Surcharge for application 450,-



631.20.250 Brausethermostat 1/2"
 für Aufputzmontage
 ■ mit Porzellangriff
 ■ Dehnstoff-Thermoelement
 ■ Sicherheitssperre bei 38° C
 ■ Keramik-Innenoberteil 1/2"

Exposed shower thermostat 1/2"
 ■ with porcelain handle
 ■ cartridge with thermoelement
 ■ locking device at 38 °C
 ■ ceramic cartridge 1/2"

A	B	C	D	E
1.289,-	1.752,-	1.943,-	2.083,-	2.815,-
F	G	H	I	L
2.518,-	2.047,-	2.524,-	3.157,-	3.716,-

Aufpreis für Applikation Surcharge for application 225,-

631.20.410 – Aufputz Set mit Steigrohr | Exposed set with shower system



649.13.844 Regenbrause 1/2", ø 240 mm
 ■ Ausführung ganz in Metall
 ■ 3 mm ultra flach
 ■ mit Kugelgelenk
 ■ Anti-Kalk-System

Rain shower head 1/2", ø 240 mm
 ■ full metal body
 ■ 3 mm ultra-thin
 ■ with ball joint
 ■ with anticalcareous system

A	B	C	D	E
499,-	1.098,-	1.289,-	1.372,-	1.622,-
F	G	H	I	L
1.452,-	1.289,-	1.599,-	1.927,-	2.529,-

649.20.210 Steigrohr, Umstellung, Wandarm
 ■ zum Anschluß an die Brausebatterie
 ■ Ausladung 360 - 380 mm
 ■ in der Neigung und Höhe verstellbare Brausehalterung

Supply pipe, diverter, wall bracket
 ■ to connect the exposed shower mixer
 ■ projection 360 - 380 mm
 ■ fitting for handshower adjustable in height and inclination

A	B	C	D	E
568,-	972,-	1.109,-	1.182,-	1.639,-
F	G	H	I	L
1.455,-	1.289,-	1.806,-	1.949,-	2.598,-

630.13.700 Brausegarnitur
 ■ Metall-Handbrause mit Anti-Kalk-System und Rückflussverhinderer
 ■ Metall-Brauseschlauch 1500 mm, beidseitig mit drehbarem Konus

Shower combination
 ■ metal hand shower with anticalc. system and backflow preventer
 ■ metal shower hose 1500 mm, both sides with turning cone

A	B	C	D	E
146,-	312,-	466,-	519,-	624,-
F	G	H	I	L
566,-	586,-	929,-	1.149,-	1.643,-

631.20.210 Brausebatterie 1/2"
 für Steigrohr-Montage
 ■ mit Porzellangriffen
 ■ 2 keramische Oberteile 1/2"
 ■ Brauseabgang 3/4"
 ■ verdeckte S-Anschlüsse 1/2" x 3/4"

Exposed shower mixer 1/2"
 for supply pipe
 ■ with porcelain handles
 ■ 2 ceramic internal upper parts 1/2"
 ■ discharge 3/4"
 ■ concealed S-connections 1/2" x 3/4"

A	B	C	D	E
1.354,-	1.562,-	1.676,-	1.745,-	2.429,-
F	G	H	I	L
2.126,-	1.784,-	2.042,-	2.649,-	3.487,-

Aufpreis für Applikation Surcharge for application 450,-

BELLEDDOR

Maßzeichnungen unter www.joerger.de - Menü SERVICE.
 Technical specifications under www.joerger.de - menu SERVICE.

A chrom chrome	[.000]	E platin matt platinum matt	[.066]
B silbernickel polished nickel	[.035]	F nerz matt mink matt	[.096]
C nerz mink	[.095]	G schwarz-matt black matt	[.092]
C nickel matt satin nickel	[.036]	G weiß-matt white matt	[.052]
D edelmessing sunshine	[.040]	H bronze bronze	[.011]
D platin platinum	[.065]	I gold gold	[.020]
E edelmess.matt sunshine matt	[.041]	L roségold rosegold	[.022]
E gold matt gold matt	[.021]	L roségold matt rosegold matt	[.023]

631.20.415 – Aufputz Set mit Steigrohr | Exposed set with shower system

	649.13.844	Regenbrause ½", ø 240 mm <ul style="list-style-type: none"> ■ Ausführung ganz in Metall ■ 3 mm ultra flach ■ mit Kugelgelenk ■ Anti-Kalk-System 	Rain shower head ½", ø 240 mm <ul style="list-style-type: none"> ■ full metal body ■ 3 mm ultra-thin ■ with ball joint ■ with anticalcareous system 	A	B	C	D	E
				499,-	1.098,-	1.289,-	1.372,-	1.622,-
				F	G	H	I	L
				1.452,-	1.289,-	1.599,-	1.927,-	2.529,-
	649.20.210	Steigrohr, Umstellung, Wandarm <ul style="list-style-type: none"> ■ zum Anschluß an die Brausebatterie ■ Ausladung 360 - 380 mm ■ in der Neigung und Höhe verstellbare Brausehalterung 	Supply pipe, diverter, wall bracket <ul style="list-style-type: none"> ■ to connect the exposed shower mixer ■ projection 360 - 380 mm ■ fitting for handshower adjustable in height and inclination 	A	B	C	D	E
				568,-	972,-	1.109,-	1.182,-	1.639,-
				F	G	H	I	L
				1.455,-	1.289,-	1.806,-	1.949,-	2.598,-
	632.13.705	Brausegarnitur <ul style="list-style-type: none"> ■ Metall-Handbrause mit Anti-Kalk-System und Rückflussverhinderer ■ Metall-Brauseschlauch 1500 mm, beidseitig mit drehbarem Konus 	Shower combination <ul style="list-style-type: none"> ■ metal hand shower with anticalc. system and backflow preventer ■ metal shower hose 1500 mm, both sides with turning cone 	A	B	C	D	E
				279,-	499,-	546,-	648,-	796,-
			F	G	H	I	L	
			784,-	598,-	896,-	1.138,-	1.379,-	
631.20.210	Brausebatterie ½" für Steigrohr-Montage <ul style="list-style-type: none"> ■ mit Porzellangriffen ■ 2 keramische Oberteile ½" ■ Brauseabgang ¾" ■ verdeckte S-Anschlüsse ½" x ¾" 	Exposed shower mixer ½" for supply pipe <ul style="list-style-type: none"> ■ with porcelain handles ■ 2 ceramic internal upper parts ½" ■ discharge ¾" ■ concealed S-connections ½" x ¾" 	A	B	C	D	E	
			1.354,-	1.562,-	1.676,-	1.745,-	2.429,-	
			F	G	H	I	L	
			2.126,-	1.784,-	2.042,-	2.649,-	3.487,-	
	Aufpreis für Applikation	Surcharge for application	450,-					

631.20.460 – Aufputz Set mit Steigrohr | Exposed set with shower system

	649.13.844	Regenbrause ½", ø 240 mm <ul style="list-style-type: none"> ■ Ausführung ganz in Metall ■ 3 mm ultra flach ■ mit Kugelgelenk ■ Anti-Kalk-System 	Rain shower head ½", ø 240 mm <ul style="list-style-type: none"> ■ full metal body ■ 3 mm ultra-thin ■ with ball joint ■ with anticalcareous system 	A	B	C	D	E
				499,-	1.098,-	1.289,-	1.372,-	1.622,-
				F	G	H	I	L
				1.452,-	1.289,-	1.599,-	1.927,-	2.529,-
	649.20.210	Steigrohr, Umstellung, Wandarm <ul style="list-style-type: none"> ■ zum Anschluß an die Brausebatterie ■ Ausladung 360 - 380 mm ■ in der Neigung und Höhe verstellbare Brausehalterung 	Supply pipe, diverter, wall bracket <ul style="list-style-type: none"> ■ to connect the exposed shower mixer ■ projection 360 - 380 mm ■ fitting for handshower adjustable in height and inclination 	A	B	C	D	E
				568,-	972,-	1.109,-	1.182,-	1.639,-
				F	G	H	I	L
				1.455,-	1.289,-	1.806,-	1.949,-	2.598,-
	630.13.700	Brausegarnitur <ul style="list-style-type: none"> ■ Metall-Handbrause mit Anti-Kalk-System und Rückflussverhinderer ■ Metall-Brauseschlauch 1500 mm, beidseitig mit drehbarem Konus 	Shower combination <ul style="list-style-type: none"> ■ metal hand shower with anticalc. system and backflow preventer ■ metal shower hose 1500 mm, both sides with turning cone 	A	B	C	D	E
				146,-	312,-	466,-	519,-	624,-
			F	G	H	I	L	
			566,-	586,-	929,-	1.149,-	1.643,-	
631.20.260	Brausethermostat ½" für Steigrohr-Montage <ul style="list-style-type: none"> ■ mit Porzellangriff ■ Dehnstoff-Thermoelement ■ Sicherheitssperre bei 38° C ■ Keramik-Innenoberteil ½" ■ verdeckte S-Anschlüsse ½" x ¾" 	Exposed shower thermostat ½" for supply pipe <ul style="list-style-type: none"> ■ with porcelain handle ■ cartridge with thermoelement ■ locking device at 38 °C ■ ceramic cartridge ½" ■ concealed S-connections ½" x ¾" 	A	B	C	D	E	
			1.338,-	1.799,-	1.992,-	2.132,-	2.864,-	
			F	G	H	I	L	
			2.566,-	2.095,-	2.572,-	3.205,-	3.764,-	
	Aufpreis für Applikation	Surcharge for application	225,-					

A chrom chrome	[.000]	E platin matt platinum matt	[.066]
B silbernickel polished nickel	[.035]	F nerz matt mink matt	[.096]
C nerz mink	[.095]	G schwarz-matt black matt	[.092]
C nickel matt satin nickel	[.036]	G weiß-matt white matt	[.052]
D edelmessing sunshine	[.040]	H bronze bronze	[.011]
D platin platinum	[.065]	I gold gold	[.020]
E edelmess.matt sunshine matt	[.041]	L roségold rosegold	[.022]
E gold matt gold matt	[.021]	L roségold matt rosegold matt	[.023]

-31 weiß white	mit Aufpreis / with surcharge
-35 schwarz black	-32 weiß/gold white/gold
	-33 weiß/platin white/platinum
	-36 schwarz/gold black/gold
	-36 schwarz/platin black/platinum

mit Aufpreis / with surcharge
-41 perlmutt mother of pearl
-42 gold gold
-43 platin platinum
-44 kobaltblau cobalt blue

631.20.465 – Aufputz Set mit Steigrohr | Exposed set with shower system

	649.13.844	Regenbrause ½", ø 240 mm <ul style="list-style-type: none"> Ausführung ganz in Metall 3 mm ultra flach mit Kugelgelenk Anti-Kalk-System 	Rain shower head ½", ø 240 mm <ul style="list-style-type: none"> full metal body 3 mm ultra-thin with ball joint with anticalcareous system 	A	B	C	D	E
				499,-	1.098,-	1.289,-	1.372,-	1.622,-
				F	G	H	I	L
				1.452,-	1.289,-	1.599,-	1.927,-	2.529,-
	649.20.210	Steigrohr, Umstellung, Wandarm <ul style="list-style-type: none"> zum Anschluß an die Brausebatterie Ausladung 360 - 380 mm in der Neigung und Höhe verstellbare Brausehalterung 	Supply pipe, diverter, wall bracket <ul style="list-style-type: none"> to connect the exposed shower mixer projection 360 - 380 mm fitting for handshower adjustable in height and inclination 	A	B	C	D	E
			568,-	972,-	1.109,-	1.182,-	1.639,-	
			F	G	H	I	L	
			1.455,-	1.289,-	1.806,-	1.949,-	2.598,-	
	632.13.705	Brausegarnitur <ul style="list-style-type: none"> Metall-Handbrause mit Anti-Kalk-System und Rückflussverhinderer Metall-Brauseschlauch 1500 mm, beidseitig mit drehbarem Konus 	Shower combination <ul style="list-style-type: none"> metal hand shower with anticalc. system and backflow preventer metal shower hose 1500 mm, both sides with turning cone 	A	B	C	D	E
			279,-	499,-	546,-	648,-	796,-	
			F	G	H	I	L	
			784,-	598,-	896,-	1.138,-	1.379,-	
	631.20.260	Brausethermostat ½" für Steigrohr-Montage <ul style="list-style-type: none"> mit Porzellangriff Dehnstoff-Thermoelement Sicherheitssperre bei 38° C Keramik-Innenoberteil ½" verdeckte S-Anschlüsse ½" x ¾" 	Exposed shower thermostat ½" for supply pipe <ul style="list-style-type: none"> with porcelain handle cartridge with thermoelement locking device at 38 °C ceramic cartridge ½" concealed S-connections ½" x ¾" 	A	B	C	D	E
			1.338,-	1.799,-	1.992,-	2.132,-	2.864,-	
			F	G	H	I	L	
			2.566,-	2.095,-	2.572,-	3.205,-	3.764,-	
	Aufpreis für Applikation		Surcharge for application	225,-				

Unterputz-Hebelmischer ½" | Concealed single lever mixer ½"

	631.20.125	1-Hand Wannenfüll- und Brausebatterie ½" für UP-Montage, Fertigmontageset <ul style="list-style-type: none"> manuelle, keramische Umstellung für druckunabhängige Funktion mit Sicherheitseinrichtung Durchflußrate 21 l/min bei 3 bar 	Concealed single lever wall tub and shower mixer ½", assembly set <ul style="list-style-type: none"> manual, ceramic diverter tub/shower for pressure-independent function with safety device flow rate 21 l/min at 3 bar 	A	B	C	D	E
				1.188,-	1.323,-	1.414,-	1.456,-	1.748,-
				F	G	H	I	L
				1.618,-	1.322,-	1.459,-	1.888,-	2.433,-
	Aufpreis für Applikation		Surcharge for application	130,-				
<u>Variante Alternative</u>								
	631.20.235	1-Hand Brausebatterie ½" für UP-Montage, Fertigmontageset <ul style="list-style-type: none"> ohne Umstellung Funktionseinheit mit ker. Scheiben Durchflußrate 20,4 l/min bei 3 bar 	Concealed single lever shower mixer ½", assembly set <ul style="list-style-type: none"> without diverter functional unit with ceramic discs flow rate 20,4 l/min at 3 bar 	A	B	C	D	E
				857,-	1.016,-	1.162,-	1.197,-	1.457,-
				F	G	H	I	L
				1.328,-	1.162,-	1.399,-	1.572,-	2.142,-
	Aufpreis für Applikation		Surcharge for application	130,-				
<u>Benötigt Required</u>								
	649.40.360	Unterputz-Einbaubox ½" <ul style="list-style-type: none"> zu Fertigmontageset 631.20.125 und 631.20.235 für Nass- und Trockenbau geeignet 	Concealed wall box ½" <ul style="list-style-type: none"> for assembly set 631.20.125 and 631.20.235 for wetwall and drywall construction 	A				
				168,-				

Maßzeichnungen unter www.joerger.de - Menü SERVICE.
 Technical specifications under www.joerger.de - menu SERVICE.

A chrom chrome	[.000]	E platin matt platinum matt	[.066]
B silbernickel polished nickel	[.035]	F nerz matt mink matt	[.096]
C nerz mink	[.095]	G schwarz-matt black matt	[.092]
C nickel matt satin nickel	[.036]	G weiß-matt white matt	[.052]
D edelmessing sunshine	[.040]	H bronze bronze	[.011]
D platin platinum	[.065]	I gold gold	[.020]
E edelmess.matt sunshine matt	[.041]	L roségold rosegold	[.022]
E gold matt gold matt	[.021]	L roségold matt rosegold matt	[.023]

-31 weiß white	mit Aufpreis / with surcharge	mit Aufpreis / with surcharge
-35 schwarz black	-32 weiß/gold white/gold	-41 perlmutt mother of pearl
	-33 weiß/platin white/platinum	-42 gold gold
	-36 schwarz/gold black/gold	-43 platin platinum
	-36 schwarz/platin black/platinum	-44 kobaltblau cobalt blue

Unterputz-Thermostate 1/2" | Wall thermostats, concealed 1/2"

	631.40.380	Unterputz-Thermostat 1/2" <u>mit</u> Mengenregulierung, Fertigmontageset	Concealed wall thermostat 1/2" <u>with</u> flow control, assembly set	A	B	C	D	E
		<ul style="list-style-type: none"> manuelle, keramische Umstellung Wanne/Brause, druckunabhängig mit Sicherheitseinrichtung Durchflussrate 20,4 l/min bei 3 bar 	<ul style="list-style-type: none"> manual, ceramic diverter tub/shower for pressure-independent function with safety device flow rate 20,4 l/min at 3 bar 	1.228,-	1.406,-	1.527,-	1.674,-	1.957,-
				F	G	H	I	L
				1.824,-	1.627,-	1.894,-	2.078,-	2.612,-
		Aufpreis für Applikation	Surcharge for application	130,-				

Variante | Alternative

	631.40.360	Unterputz-Thermostat 1/2" <u>mit</u> Mengenregulierung, Fertigmontageset	Concealed wall thermostat 1/2" <u>with</u> flow control, assembly set	A	B	C	D	E
		<ul style="list-style-type: none"> <u>ohne</u> Umstellung mit integrierter keramischer Mengenregulierung Durchflussrate 20,4 l/min bei 3 bar 	<ul style="list-style-type: none"> <u>without</u> diverter with integrated ceramic cartridge for volume control flow rate 20,4 l/min at 3 bar 	1.214,-	1.392,-	1.514,-	1.659,-	1.944,-
				F	G	H	I	L
				1.809,-	1.614,-	1.879,-	2.064,-	2.598,-
		Aufpreis für Applikation	Surcharge for application	130,-				

Variante | Alternative

	631.40.460	Unterputz-Thermostat 1/2" <u>ohne</u> Mengenregulierung, Fertigmontageset	Concealed wall thermostat 1/2" <u>without</u> flow control, assembly set	A	B	C	D	E
		<ul style="list-style-type: none"> Funktionseinheit <u>ohne</u> Umstellung und <u>ohne</u> Absperrung Durchflussrate 25,8 l/min bei 3 bar 	<ul style="list-style-type: none"> Functional unit <u>without</u> diverter and <u>without</u> shut-off flow rate 25,8 l/min at 3 bar 	926,-	1.125,-	1.222,-	1.339,-	1.565,-
				F	G	H	I	L
				1.459,-	1.299,-	1.515,-	1.714,-	2.089,-
		Aufpreis für Applikation	Surcharge for application	130,-				

Benötigt | Required

	649.40.360	Unterputz-Einbaubox 1/2"	Concealed wall box 1/2"	A				
		<ul style="list-style-type: none"> zu Fertigmontageset 631.40.360, 631.40.380 und 631.40.460 für Nass- und Trockenbau geeignet 	<ul style="list-style-type: none"> for assembly set 631.40.360, 631.40.380 and 631.40.460 for wetwall and drywall construction 	168,-				

Unterputz-Thermostat 3/4" mit hohem Durchfluß | Wall thermostat, concealed 3/4" with high flow

	631.40.555	Unterputz-Thermostat 3/4" <u>ohne</u> Mengenregulierung, Fertigmontageset	Concealed wall thermostat 3/4" <u>without</u> flow control, assembly set	A	B	C	D	E
		<ul style="list-style-type: none"> serienbezogener Temperiergriff Sicherheitsperre bei 38° C 	<ul style="list-style-type: none"> design handle for temp. control locking device at 38°C 	742,-	860,-	1.079,-	1.129,-	1.426,-
				F	G	H	I	L
				1.339,-	1.089,-	1.396,-	1.618,-	2.412,-
		Aufpreis für Applikation	Surcharge for application	130,-				

Benötigt | Required

	649.40.555	Unterputz-Einbaukörper 3/4"	Concealed thermostat body 3/4"	A				
		<ul style="list-style-type: none"> zu Fertigmontageset 631.40.555 Kartusche mit Schmutzfangsieben für Nass- und Trockenbau geeignet Durchflussrate 64,2 l/min bei 3 bar <u>ohne</u> Absperrung 	<ul style="list-style-type: none"> for assembly set 631.40.555 cartridge with filter screens for wetwall and drywall construction flow rate 64,2 l/min at 3 bar <u>without</u> shut-off 	1.636,-				

A chrom chrome	[.000]	E platin matt platinum matt	[.066]
B silbernickel polished nickel	[.035]	F nerz matt mink matt	[.096]
C nerz mink	[.095]	G schwarz-matt black matt	[.092]
C nickel matt satin nickel	[.036]	G weiß-matt white matt	[.052]
D edelmessing sunshine	[.040]	H bronze bronze	[.011]
D platin platinum	[.065]	I gold gold	[.020]
E edelmess.matt sunshine matt	[.041]	L roségold rosegold	[.022]
E gold matt gold matt	[.021]	L roségold matt rosegold matt	[.023]

-31 weiß | white
 -35 schwarz | black

mit Aufpreis / with surcharge
 -32 weiß/gold | white/gold
 -33 weiß/platin | white/platinum
 -36 schwarz/gold | black/gold
 -36 schwarz/platin | black/platinum

mit Aufpreis / with surcharge
 -41 perlmutt | mother of pearl
 -42 gold | gold
 -43 platin | platinum
 -44 kobaltblau | cobalt blue

Unterputz-Thermostat ¾" | Wall thermostat, concealed ¾"



631.40.520 Unterputz-Thermostat ¾"
ohne Mengenregulierung,
 Fertigmontageset
 ■ serienbezogener Temperiergriff
 ■ Sicherheitssperre bei 38° C

Concealed wall thermostat ¾"
without flow control,
 assembly set
 ■ design handle for temp. control
 ■ locking device at 38°C

A	B	C	D	E
742,-	860,-	1.079,-	1.129,-	1.426,-
F	G	H	I	L
1.339,-	1.089,-	1.396,-	1.618,-	2.412,-

Aufpreis für Applikation Surcharge for application 130,-

Benötigt | Required



649.40.520 Unterputz-Einbaukörper ¾"
 ■ zu Fertigmontageset 631.40.520
 ■ Kartusche mit Schmutzfangsiebern
 ■ für Nass- und Trockenbau geeignet
 ■ Durchflussrate 41 l/min bei 3 bar
 ■ ohne Absperrung

Concealed thermostat body ¾"
 ■ for assembly set 631.40.520
 ■ cartridge with filter screens
 ■ for wetwall and drywall construction
 ■ flow rate 41 l/min at 3 bar
 ■ without shut-off

A	B	C	D	E
498,-				

Unterputz-Umstellung | Diverter, concealed



631.40.650 Unterputz 3-Wege Umstellung
 Fertigmontageset
 ■ mit Porzellangriff
 ■ Schubrosette, Hülse

Concealed 3-position diverter
 assembly set
 ■ porcelain handle
 ■ socket with adjustable escutcheon

A	B	C	D	E
396,-	439,-	499,-	542,-	626,-
F	G	H	I	L
584,-	486,-	556,-	668,-	856,-

Aufpreis für Applikation Surcharge for application 225,-

Benötigt | Required



649.40.600 Unterputz 3-Wege Umstellung
 Einbaukörper ½"
 ■ zu Fertigmontageset 631.40.650

Concealed 3-position diverter
 diverter body ½"
 ■ for assembly set 631.40.650

A	B	C	D	E
236,-				

Unterputz-Ventile | Valves, concealed



631.50.234 Unterputz-Ventil
 Fertigmontageset
 ■ mit Porzellangriff
 ■ Schubrosette, Hülse

Concealed wall valve
 assembly set
 ■ porcelain handle
 ■ socket with adjustable escutcheon

A	B	C	D	E
396,-	439,-	499,-	542,-	626,-
F	G	H	I	L
584,-	486,-	556,-	668,-	856,-

Aufpreis für Applikation Surcharge for application 225,-

Benötigt | Required



649.20.350 Unterputz-Ventil ½", Einbaukörper
 ■ rechtsschließend, ker. Scheiben

Concealed wall valve ½", body
 ■ clockwise closure, ceramic discs

A	B	C	D	E
66,-				

649.20.355 Unterputz-Ventil ½", Einbaukörper
 ■ linksschließend, ker. Scheiben

Concealed wall valve ½", body
 ■ counter-clockwise closure, cer. discs



649.20.450 Unterputz-Ventil ¾", Einbaukörper
 ■ rechtsschließend, ker. Scheiben

Concealed wall valve ¾", body
 ■ clockwise closure, ceramic discs

A	B	C	D	E
99,-				

649.20.455 Unterputz-Ventil ¾", Einbaukörper
 ■ linksschließend, ker. Scheiben

Concealed wall valve ¾", body
 ■ counter-clockwise closure, cer. discs

Maßzeichnungen unter www.joerger.de - Menü SERVICE.
 Technical specifications under www.joerger.de - menu SERVICE.

A chrom chrome	[.000]	E platin matt platinum matt	[.066]
B silbernickel polished nickel	[.035]	F nerz matt mink matt	[.096]
C nerz mink	[.095]	G schwarz-matt black matt	[.092]
C nickel matt satin nickel	[.036]	G weiß-matt white matt	[.052]
D edelmessing sunshine	[.040]	H bronze bronze	[.011]
D platin platinum	[.065]	I gold gold	[.020]
E edelmess.matt sunshine matt	[.041]	L roségold rosegold	[.022]
E gold matt gold matt	[.021]	L roségold matt rosegold matt	[.023]

-31 weiß white	mit Aufpreis / with surcharge	mit Aufpreis / with surcharge
-35 schwarz black	-32 weiß/gold white/gold	-41 perlmutter mother of pearl
	-33 weiß/platin white/platinum	-42 gold gold
	-36 schwarz/gold black/gold	-43 platin platinum
	-36 schwarz/platin black/platinum	-44 kobaltblau cobalt blue

Unterputz-Thermostat/Ventil-Modul | Concealed thermostatic/wall-valve modul



631.60.432	Unterputz-Ventil-Modul Fertigmontageset <ul style="list-style-type: none"> mit Porzellangriff Rosette 	Concealed wall-valve-modul assembly set <ul style="list-style-type: none"> porcelain handle escutcheon 	A	B	C	D	E
			376,-	439,-	474,-	516,-	599,-
			F	G	H	I	L
			558,-	459,-	529,-	642,-	829,-
Aufpreis für Applikation		Surcharge for application	225,-				

Benötigt | Required



649.20.610	Unterputz-Ventil-Modul, 1-fach <ul style="list-style-type: none"> 1x Spindelventil 3/4", rechtsschließend mit keram. Scheiben 2 Abgänge 1/2", je 1x rechts/links möglich, gleichzeitig benutzbar 	Concealed wall-valve-modul, single <ul style="list-style-type: none"> 1x spindle valve 3/4", clockwise closure with ceramic discs 2 outlets 1/2", each 1x right/left possible, simultaneously usable 	A				
			229,-				



649.20.620	Unterputz-Ventil-Modul, 2-fach <ul style="list-style-type: none"> 2x Spindelventil 3/4", rechtsschließend mit keram. Scheiben 4 Abgänge 1/2", je 2x rechts/links möglich, gleichzeitig benutzbar im Verbund maßgenaue Montage erweiterbar mit 649.20.610 	Concealed wall-valve-modul, double <ul style="list-style-type: none"> 2x spindle valve 3/4", clockwise closure with ceramic discs 4 outlets 1/2", each 2x right/left possible, simultaneously usable precise assembly due to composite expandable with 649.20.610 	A				
			458,-				



649.20.630	Unterputz-Ventil-Modul, 3-fach <ul style="list-style-type: none"> 3x Spindelventil 3/4", rechtsschließend mit keram. Scheiben 6 Abgänge 1/2", je 3x rechts/links möglich, gleichzeitig benutzbar im Verbund maßgenauen Montage erweiterbar mit 649.20.610 	Concealed wall-valve-modul, triple <ul style="list-style-type: none"> 3x spindle valve 3/4", clockwise closure with ceramic discs 6 outlets 1/2", each 3x right/left possible, simultaneously usable precise assembly due to composite expandable with 649.20.610 	A				
			686,-				



631.40.460	Unterputz-Thermostat 1/2" ohne Mengenregulierung, Fertigmontageset <ul style="list-style-type: none"> Funktionseinheit ohne Umstellung und ohne Absperrung Durchflussrate 25,8 l/min bei 3 bar 	Concealed wall thermostat 1/2" without flow control, assembly set <ul style="list-style-type: none"> Functional unit without diverter and without shut-off flow rate 25,8 l/min at 3 bar 	A	B	C	D	E
			926,-	1.125,-	1.222,-	1.339,-	1.565,-
			F	G	H	I	L
			1.459,-	1.299,-	1.515,-	1.714,-	2.089,-
Aufpreis für Applikation		Surcharge for application	130,-				

Benötigt | Required

649.20.612	Anschlußadapter 1/2" <ul style="list-style-type: none"> Anschlußadapter, Abschlußstopfen passend zu Einbaubox 649.40.360 	Connection adapter 1/2" <ul style="list-style-type: none"> connection adapter, end plug matching to wall box 649.40.360 	A				
			122,-				



649.40.360	Unterputz-Einbaubox 1/2" <ul style="list-style-type: none"> zu Fertigmontageset 631.40.460 für Nass- und Trockenbau geeignet 	Concealed wall box 1/2" <ul style="list-style-type: none"> for assembly set 631.40.460 for wetwall and drywall construction 	A				
			168,-				

A chrom chrome	[.000]	E platin matt platinum matt	[.066]
B silbernickel polished nickel	[.035]	F nerz matt milk matt	[.096]
C nerz milk	[.095]	G schwarz-matt black matt	[.092]
C nickel matt satin nickel	[.036]	G weiß-matt white matt	[.052]
D edelmessing sunshine	[.040]	H bronze bronze	[.011]
D platin platinum	[.065]	I gold gold	[.020]
E edelmess.matt sunshine matt	[.041]	L roségold rosegold	[.022]
E gold matt gold matt	[.021]	L roségold matt rosegold matt	[.023]

- 31 weiß | white
- 35 schwarz | black
- mit Aufpreis / with surcharge
- 32 weiß/gold | white/gold
- 33 weiß/platin | white/platinum
- 36 schwarz/gold | black/gold
- 36 schwarz/platin | black/platinum

- mit Aufpreis / with surcharge
- 41 perlmutt | mother of pearl
- 42 gold | gold
- 43 platin | platinum
- 44 kobaltblau | cobalt blue

Unterputz-Thermostat/Ventil-Modul | Concealed thermostatic/wall-valve modul



631.40.555 Unterputz-Thermostat ¾“
ohne Mengenregulierung,
 Fertigmontageset

- serienbezogener Temperiergriff
- Sicherheitssperre bei 38° C

Concealed wall thermostat ¾“
without flow control,
 assembly set

- design handle for temp. control
- locking device at 38°C

A	B	C	D	E
742,-	860,-	1.079,-	1.129,-	1.426,-
F	G	H	I	L
1.339,-	1.089,-	1.396,-	1.618,-	2.412,-

Aufpreis für Applikation	Surcharge for application	130,-
--------------------------	---------------------------	-------

Benötigt | Required

649.20.634 Anschlußadapter ½“

- Anschlußadapter, Abschlußstopfen
- passend zu Einbaukörper 649.40.555



Connection adapter ½“

- connection adapter, end plug
- matching to concealed body 649.40.555

A	B	C	D	E
146,-				

649.40.555 Unterputz-Einbaukörper ¾“

- zu Fertigmontageset 638.40.555
- Kartusche mit Schmutzfangsieben
- für Nass- und Trockenbau geeignet
- Durchflußrate 64,2 l/min bei 3 bar
- ohne Absperrung



Concealed thermostat body ¾“

- for assembly set 638.40.555
- cartridge with filter screens
- for wetwall and drywall construction
- flow rate 64,2 l/min at 3 bar
- without shut-off

A	B	C	D	E
1.636,-				

Brausen | Showers



631.13.310 Duschgarnitur, komplett

- Wandrohr 795 mm, mit Schieber
- Metall-Handbrause mit Anti-Kalk-System und Rückflussverhinderer
- Metall-Brauseschlauch 1750 mm, beidseitig mit drehbarem Konus

Shower bar set, complete

- wall bar 795 mm, with slider
- metal hand shower with anticalc. system and backflow preventer
- metal shower hose 1750 mm, both sides with turning cone

A	B	C	D	E
759,-	1.069,-	1.226,-	1.312,-	1.739,-
F	G	H	I	L
1.556,-	1.379,-	1.859,-	2.429,-	3.189,-

631.13.350 Duschstange, lose

- Wandrohr 795 mm, mit Schieber

Shower bar, separate

- wall bar 795 mm, with slider

A	B	C	D	E
599,-	899,-	974,-	1.024,-	1.294,-
F	G	H	I	L
1.176,-	918,-	1.079,-	1.588,-	2.044,-



631.13.315 Duschgarnitur, komplett

- Wandrohr 795 mm, mit Schieber
- Metall-Handbrause mit Anti-Kalk-System und Rückflussverhinderer
- Metall-Brauseschlauch 1750 mm, beidseitig mit drehbarem Konus

Shower bar set, complete

- wall bar 795 mm, with slider
- metal hand shower with anticalc. system and backflow preventer
- metal shower hose 1750 mm, both sides with turning cone

A	B	C	D	E
854,-	1.229,-	1.439,-	1.548,-	2.068,-
F	G	H	I	L
1.846,-	1.450,-	1.926,-	2.489,-	3.250,-



631.13.200 Schlauchbrausegarnitur

- Wandanschlußbogen ½“, Schubrosette, Wand-Brausehalter
- Metall-Handbrause mit Anti-Kalk-System und Rückflussverhinderer
- Metall-Brauseschlauch 1500 mm

Shower combination

- wall elbow connection ½“
- wall fitting for hand shower
- metal hand shower with anticalc. system and backflow preventer
- flexible metal shower hose 1500 mm

A	B	C	D	E
363,-	529,-	622,-	669,-	926,-
F	G	H	I	L
818,-	776,-	1.094,-	1.212,-	1.628,-

A chrom chrome	[.000]	E platin matt platinum matt	[.066]
B silbernickel polished nickel	[.035]	F nerz matt mink matt	[.096]
C nerz mink	[.095]	G schwarz-matt black matt	[.092]
C nickel matt satin nickel	[.036]	G weiß-matt white matt	[.052]
D edelmessing sunshine	[.040]	H bronze bronze	[.011]
D platin platinum	[.065]	I gold gold	[.020]
E edelmess.matt sunshine matt	[.041]	L roségold rosegold	[.022]
E gold matt gold matt	[.021]	L roségold matt rosegold matt	[.023]

Maßzeichnungen unter www.joerger.de - Menü SERVICE.
 Technical specifications under www.joerger.de - menu SERVICE.

-31 weiß white	mit Aufpreis / with surcharge	mit Aufpreis / with surcharge
-35 schwarz black	-32 weiß/gold white/gold	-41 perlmutt mother of pearl
	-33 weiß/platin white/platinum	-42 gold gold
	-36 schwarz/gold black/gold	-43 platin platinum
	-36 schwarz/platin black/platinum	-44 kobaltblau cobalt blue

	631.13.205 Schlauchbrausegarnitur ■ Wandanschlußbogen ½", Schubrosette, Wand-Brausehalter ■ Metall-Handbrause mit Anti-Kalk-System und Rückflussverhinderer ■ Metall-Brauseschlauch 1500 mm	Shower combination ■ wall elbow connection ½" ■ wall fitting for hand shower ■ metal hand shower with anticalc. system and backflow preventer ■ flexible metal shower hose 1500 mm	A	B	C	D	E
			464,-	698,-	836,-	904,-	1.228,-
			F	G	H	I	L
			1.089,-	848,-	1.159,-	1.376,-	1.692,-

	631.13.150 Wandanschlußbogen ½", ohne Haken ■ Brauseabgang ½" ■ mit Rückflussverhinderer, Rosette	Wall elbow connection ½", without cradle ■ discharge ½" ■ with backflow preventer, escutcheon	A	B	C	D	E
			112,-	158,-	168,-	176,-	239,-
			F	G	H	I	L
			219,-	168,-	208,-	270,-	354,-

	649.13.260 Wand-Brausehalter	Wall fitting for hand shower	A	B	C	D	E
			149,-	191,-	198,-	208,-	269,-
			F	G	H	I	L
			246,-	198,-	234,-	299,-	359,-

	631.13.237 Hygienebrausegarnitur ■ Wandbrausehalter und -anschlußbogen ½", Schubrosette ■ Hygienebrause, klassisch (649.13.338), komplett aus Metall ■ einstrahlig, Bedienung über Druckhebel ■ Metall-Brauseschlauch 1250 mm	Ablution spray combination ■ wall fitting and elbow connection ½" ■ spray handshower, classical (649.13.338), completely metal ■ one jet, push-lever operation ■ flexible metal shower hose 1250 mm	A	B	C	D	E
			265,-	386,-	435,-	479,-	654,-
			F	G	H	I	L
			629,-	682,-	1.008,-	1.216,-	1.539,-

	631.20.237 1-Hand Batterie ½" für Hygiene-Brause, Fertigmontageset ■ Rosette, Griff	Concealed single lever ½" for abluition spray, assembly set ■ escutcheon, handle	A	B	C	D	E
			499,-	594,-	684,-	747,-	840,-
			F	G	H	I	L
			794,-	684,-	774,-	926,-	1.289,-

Aufpreis für Applikation	Surcharge for application	100,-
---------------------------------	----------------------------------	--------------

Benötigt | Required

	649.20.237 Unterputz 1-Hand Batterie ½", Einbaukörper ■ Kartusche mit keramischen Scheiben ■ zu Fertigmontageset 631.20.237	Single lever mixer ½", concealed body ■ cartridge with ceramic discs ■ for assembly set 631.20.237	A	B	C	D	E
			125,-	169,-	208,-	229,-	268,-
			F	G	H	I	L
			249,-	224,-	258,-	329,-	396,-

A chrom chrome	[.000]	E platin matt platinum matt	[.066]
B silbernickel polished nickel	[.035]	F nerz matt milk matt	[.096]
C nerz milk	[.095]	G schwarz-matt black matt	[.092]
C nickel matt satin nickel	[.036]	G weiß-matt white matt	[.052]
D edelmessing sunshine	[.040]	H bronze bronze	[.011]
D platin platinum	[.065]	I gold gold	[.020]
E edelmess.matt sunshine matt	[.041]	L roségold rosegold	[.022]
E gold matt gold matt	[.021]	L roségold matt rosegold matt	[.023]



649.13.930 Regenbrause 1/2", ø 300 mm

- Ausführung ganz in Metall
- mit Kugelgelenk
- Anti-Kalk-System
- ohne Wandarm

- weitere, zur Serie passende Kopfbrausen siehe Kapitel "Brausen"

Rain shower head 1/2", ø 300 mm

- full metal body
- with ball joint
- with anticalcareous system
- without wall bracket

- for further shower heads matching this collection see chapter "showers"

A	B	C	D	E
776,-	1.279,-	1.446,-	1.524,-	2.092,-
F	G	H	I	L
1.828,-	1.479,-	2.110,-	2.242,-	3.364,-

Empfohlen | Recommended



649.13.755 Wandarm 1/2"

- Ausladung 350 mm

- weitere, zur Serie passende Wandarme siehe Kapitel "Brausen"

Wall bracket 1/2"

- projection 350 mm

- for further wall brackets matching this collection see chapter "showers"

A	B	C	D	E
129,-	288,-	316,-	349,-	439,-
F	G	H	I	L
399,-	288,-	328,-	479,-	539,-



649.13.519 Seitenbrause 1/2"

- Rosette ø 130 mm, Wandmontage
- Brausekopf schwenkbar, 20°
- Anti-Kalk-System
- Ausführung Kunststoff

- weitere, zur Serie passende Seitenbrausen siehe Kapitel "Brausen"

Body spray side shower 1/2"

- escutcheon ø 130 mm, wall assembly
- swivel shower head, 20°
- anticalcareous system
- material: plastic

- for further side showers matching this collection see chapter "showers"

A	B	C	D	E
167,-	326,-	385,-	399,-	542,-
F	G	H	I	L
496,-	376,-	472,-	634,-	949,-



649.13.395 Handbrause 1/2"

- Anti-Kalk-System
- 3 Strahlarten: Normal, Massage, Soft
- Anschluß 1/2"
- Ausführung Kunststoff

- weitere, zur Serie passende Handbrausen siehe Kapitel "Brausen"

Hand shower 1/2"

- anticalcareous system
- 3 jets: normal, hydromassage, soft
- connection 1/2"
- plastic

- for further hand showers matching this collection see chapter "showers"

A	B	C	D	E
165,-	239,-	299,-	349,-	509,-
F	G	H	I	L
418,-	297,-	436,-	648,-	856,-



649.13.391 Handbrause 1/2"

- Anti-Kalk-System
- Anschluß 1/2"
- Ausführung Metall

- weitere, zur Serie passende Handbrausen siehe Kapitel "Brausen"

Hand shower 1/2"

- anticalcareous system
- connection 1/2"
- material metal

- for further hand showers matching this collection see chapter "showers"

A	B	C	D	E
208,-	398,-	426,-	464,-	578,-
F	G	H	I	L
546,-	394,-	586,-	718,-	956,-

A chrom chrome	[.000]	E platin matt platinum matt	[.066]
B silbernickel polished nickel	[.035]	F nerz matt milk matt	[.096]
C nerz milk	[.095]	G schwarz-matt black matt	[.092]
C nickel matt satin nickel	[.036]	G weiß-matt white matt	[.052]
D edelmessing sunshine	[.040]	H bronze bronze	[.011]
D platin platinum	[.065]	I gold gold	[.020]
E edelmess.matt sunshine matt	[.041]	L roségold rosegold	[.022]
E gold matt gold matt	[.021]	L roségold matt rosegold matt	[.023]

Maßzeichnungen unter www.joerger.de - Menü SERVICE.
 Technical specifications under www.joerger.de - menu SERVICE.

Accessoires für Handtücher | Accessories for towels

	631.00.002 Handtuchhalter, doppelt ■ Rohre schwenkbar, ca. 410 mm	Double towel bar ■ swivelling bars, approx. 410 mm	A	B	C	D	E
			326,-	459,-	499,-	549,-	679,-
			F	G	H	I	L
			599,-	594,-	699,-	746,-	1.189,-

	631.00.047 Handtuchring ■ ø ca. 190 mm ■ geschlossene Ausführung	Towel ring ■ ø approx. 190 mm ■ closed version	A	B	C	D	E
			267,-	349,-	406,-	436,-	578,-
			F	G	H	I	L
			518,-	385,-	460,-	644,-	861,-

	631.00.022 Handtuchhaken, doppelt	Double robe hanger	A	B	C	D	E
			156,-	198,-	243,-	256,-	331,-
			F	G	H	I	L
			294,-	248,-	304,-	360,-	540,-

	631.00.040 Badetuchhalter ■ ca. 800 mm	Bath towel bar ■ approx. 800 mm	A	B	C	D	E
			493,-	598,-	666,-	753,-	958,-
			F	G	H	I	L
			864,-	666,-	889,-	1.098,-	1.698,-







	631.00.031 Wannengriff ■ ca. 330 mm	Tub handle ■ approx. 330 mm	A	B	C	D	E
			422,-	498,-	551,-	622,-	755,-
			F	G	H	I	L
			677,-	551,-	699,-	898,-	1.310,-

	631.00.030 Duschtürgriff ■ ca. 550 mm	Shower door handle ■ approx. 550 mm	A	B	C	D	E
			815,-	1.024,-	1.165,-	1.265,-	1.585,-
			F	G	H	I	L
			1.432,-	1.233,-	1.587,-	1.930,-	2.634,-

	634.00.104 Gästehandtuchkorb, eckig ■ mit Ablage ■ Korbgröße 260 x 150 x 190 mm	Guest towel basket, angular ■ with shelf ■ basket size 260 x 150 x 190 mm	A	B	C	D	E
			230,-	314,-	356,-	389,-	528,-
			F	G	H	I	L
			466,-	492,-	675,-	849,-	1.499,-

A chrom chrome	[.000]	E platin matt platinum matt	[.066]
B silbernickel polished nickel	[.035]	F nerz matt milk matt	[.096]
C nerz milk	[.095]	G schwarz-matt black matt	[.092]
C nickel matt satin nickel	[.036]	G weiß-matt white matt	[.052]
D edelmessing sunshine	[.040]	H bronze bronze	[.011]
D platin platinum	[.065]	I gold gold	[.020]
E edelmess.matt sunshine matt	[.041]	L roségold rosegold	[.022]
E gold matt gold matt	[.021]	L roségold matt rosegold matt	[.023]

Accessoires für Waschplatz | Accessories for washstands

			A	B	C	D	E
	631.00.007 Seifenhalter, komplett	Soap dish holder, complete					
	<ul style="list-style-type: none"> Seifenschale aus Kristallglas, seidenmatt 	<ul style="list-style-type: none"> crystal glass dish, frosted 	198,-	228,-	244,-	276,-	318,-
			F	G	H	I	L
			299,-	275,-	334,-	346,-	519,-
			<hr/>				
			A				
			90,-				
			<hr/>				
	631.00.017 Seifenhalter, komplett	Soap dish holder, complete					
	<ul style="list-style-type: none"> Standmodell Seifenschale aus Kristallglas, seidenmatt 	<ul style="list-style-type: none"> free standing version crystal glass dish, frosted 	159,-	189,-	205,-	237,-	279,-
			F	G	H	I	L
			260,-	236,-	295,-	307,-	480,-
			<hr/>				
	634.00.105 Schwammkorb	Sponge basket					
	<ul style="list-style-type: none"> rechteckig, 260 x 130 mm 	<ul style="list-style-type: none"> rectangular, 260 x 130 mm 	199,-	238,-	279,-	332,-	462,-
			F	G	H	I	L
			396,-	348,-	459,-	589,-	859,-
			<hr/>				
	634.00.106 Eckschwammkorb	Corner sponge basket					
	<ul style="list-style-type: none"> 195 x 195 mm 	<ul style="list-style-type: none"> 195 x 195 mm 	195,-	234,-	275,-	328,-	458,-
			F	G	H	I	L
			390,-	344,-	455,-	585,-	855,-
			<hr/>				
	631.00.006 Lotionspender, komplett	Soap dispenser, complete					
	<ul style="list-style-type: none"> Glas aus Kristallglas, seidenmatt 	<ul style="list-style-type: none"> crystal glass, frosted 	230,-	263,-	281,-	316,-	362,-
			F	G	H	I	L
			341,-	324,-	410,-	487,-	738,-
			<hr/>				
			A				
			96,-				
			<hr/>				
	631.00.016 Lotionspender, komplett	Soap dispenser, complete					
	<ul style="list-style-type: none"> Standmodell Glas aus Kristallglas, seidenmatt 	<ul style="list-style-type: none"> free standing version crystal glass, frosted 	189,-	224,-	242,-	277,-	323,-
			F	G	H	I	L
			299,-	295,-	378,-	448,-	718,-

BELLEDDOR

A chrom chrome	[.000]	E platin matt platinum matt	[.066]
B silbernickel polished nickel	[.035]	F nerz matt mink matt	[.096]
C nerz mink	[.095]	G schwarz-matt black matt	[.092]
C nickel matt satin nickel	[.036]	G weiß-matt white matt	[.052]
D edelmessing sunshine	[.040]	H bronze bronze	[.011]
D platin platinum	[.065]	I gold gold	[.020]
E edelmess.matt sunshine matt	[.041]	L roségold rosegold	[.022]
E gold matt gold matt	[.021]	L roségold matt rosegold matt	[.023]

Maßzeichnungen unter www.joerger.de - Menü SERVICE.
 Technical specifications under www.joerger.de - menu SERVICE.

	631.00.036 Glashalter, komplett ■ Glas aus Kristallglas, seidenmatt	Tumbler holder, complete ■ crystal glass tumbler, frosted	A	B	C	D	E
			209,-	239,-	255,-	287,-	329,-
			F	G	H	I	L
			310,-	286,-	345,-	357,-	530,-
737.00.336 Mundglas, lose			Glass tumbler, separate				
			A				
			92,-				

	631.00.046 Glashalter, komplett ■ Standmodell ■ Glas aus Kristallglas, seidenmatt	Tumbler holder, complete ■ free standing version ■ crystal glass tumbler, frosted	A	B	C	D	E
			169,-	199,-	215,-	247,-	289,-
			F	G	H	I	L
			270,-	246,-	305,-	317,-	490,-

Accessoires für WC-Bereich | Accessories for w.c. area

	631.00.014 Papierhalter ■ mit Deckel	Toilet paper roll holder ■ with lid	A	B	C	D	E
			242,-	296,-	332,-	372,-	449,-
			F	G	H	I	L
			406,-	398,-	599,-	644,-	1.044,-

	631.00.015 Reserve-Papierhalter	Spare toilet paper roll holder	A	B	C	D	E
			229,-	282,-	316,-	352,-	426,-
			F	G	H	I	L
			385,-	378,-	569,-	616,-	986,-

	631.00.000 Klosettbürstengarnitur, komplett ■ Glas aus Kristallglas, seidenmatt	Toilet brush holder set, complete ■ crystal glass, frosted	A	B	C	D	E
			365,-	419,-	442,-	467,-	526,-
			F	G	H	I	L
			498,-	426,-	564,-	698,-	898,-

799.00.301 Bürstenglas, seidenmatt, lose			Brush glass, frosted, separate				
			A				
			29,-				

	687.00.053 Bürstenstange komplett, lose	Brush rod with brush, separate	A	B	C	D	E
			178,-	204,-	215,-	228,-	257,-
			F	G	H	I	L
			243,-	208,-	275,-	339,-	438,-

799.00.240 Bürstenkopf, lose			Brush, separate				
			A				
			19,-				

Maßzeichnungen unter www.joerger.de - Menü SERVICE.
 Technical specifications under www.joerger.de - menu SERVICE.

A chrom chrome	[.000]	E platin matt platinum matt	[.066]
B silbernickel polished nickel	[.035]	F nerz matt milk matt	[.096]
C nerz milk	[.095]	G schwarz-matt black matt	[.092]
C nickel matt satin nickel	[.036]	G weiß-matt white matt	[.052]
D edelmessing sunshine	[.040]	H bronze bronze	[.011]
D platin platinum	[.065]	I gold gold	[.020]
E edelmess.matt sunshine matt	[.041]	L roségold rosegold	[.022]
E gold matt gold matt	[.021]	L roségold matt rosegold matt	[.023]



631.00.001 Klosettbürstengarnitur, komplett
 ■ stehendes Modell
 ■ Bürstentopf aus Metall

Toilet brush holder set, complete
 ■ floor standing model
 ■ brush holder out of brass

A	B	C	D	E
292,-	335,-	354,-	399,-	556,-
F	G	H	I	L
492,-	444,-	684,-	924,-	1.289,-

Spiegel | Mirrors



649.00.414 Kosmetikspiegel, beleuchtet
 ■ schwenk- und ausziehbar
 ■ 3-fache Vergrößerung
 ■ Direktanschluss
 ■ Spiegeldurchmesser 185 mm
 ■ Rahmendurchmesser 250 mm
 ■ Kalt-, Warm- und Taglicht durch Piezzo-Schalter umschaltbar

Cosmetic mirror, incl. lighting
 ■ swivelling and extendable
 ■ magnification 3:1
 ■ direct connection
 ■ mirror diameter 185 mm
 ■ frame diameter 250 mm
 ■ cold, warm and day light switchable by Piezzo switch

A	B	C	D	E
556,-	988,-	1.214,-	1.418,-	1.828,-
F	G	H	I	L
1.684,-	1.214,-	1.549,-	2.138,-	2.998,-





Oberflächen | colours

Folgende Oberflächen sind bei dieser Serie möglich |
The following colours are possible with this collection

chrom		chrome	[.000]	PG A
chrom/gold		chrome/gold	[.002]	PG B
silbernickel		polished nickel	[.035]	PG B
nerz		mink	[.095]	PG C
nickel matt		satin nickel	[.036]	PG C
edelmessing		sunshine	[.040]	PG D
platin		platinum	[.065]	PG D
edelmessing matt		sunshine matt	[.041]	PG E
gold matt		gold matt	[.021]	PG E
platin matt		platinum matt	[.066]	PG E
nerz matt		mink matt	[.096]	PG F
schwarz matt		black matt	[.092]	PG G
weiß matt		white matt	[.052]	PG G
bronze		bronze	[.011]	PG H
gold		gold	[.020]	PG I
roségold		rosegold	[.022]	PG L
roségold matt		rosegold matt	[.023]	PG L

Andere Oberflächen auf Anfrage |
Different colours on request

Auf Anfrage können wir Produkte von Drittanbietern auch gerne passend zu unseren Oberflächen veredeln (vorbehaltlich der Eignungsprüfung) | Third-party products may be plated matching to our colours on request (subject to valuation of suitability)

Waschtisch | Washbasin

ab Seite | from page 152

Bidet | Bidet

ab Seite | from page 154

Wanne | Bath tub

ab Seite | from page 156

Dusche | Shower

ab Seite | from page 159











Accessoires | Accessories

ab Seite | from page 169

Maßzeichnungen unter www.joerger.de - Menü SERVICE.
 Technical specifications under www.joerger.de - menu SERVICE.

A chrom chrome	[.000]	E platin matt platinum matt	[.066]
B silbernickel polished nickel	[.035]	F nerz matt mink matt	[.096]
C nerz mink	[.095]	G schwarz-matt black matt	[.092]
C nickel matt satin nickel	[.036]	G weiß-matt white matt	[.052]
D edelmessing sunshine	[.040]	H bronze bronze	[.011]
D platin platinum	[.065]	I gold gold	[.020]
E edelmess.matt sunshine matt	[.041]	L roségold rosegold	[.022]
E gold matt gold matt	[.021]	L roségold matt rosegold matt	[.023]

Waschtisch Batterien | Washbasin mixer

	109.30.300 Waschtisch 3-Loch Batterie 1/2" <ul style="list-style-type: none"> ■ mit Kreuzgriffen ■ Ausladung 165 mm; Höhe 240 mm ■ Auslauf schwenkbar ■ mit keramischen Oberteilen 1/4" ■ Exzentergarnitur 1 1/4" ■ empfohlen: 2x 649.15.530 - Kupferrohr 300 mm 	Washbasin 3-hole mixer 1/2" <ul style="list-style-type: none"> ■ with cross handles ■ spout projection 165 mm; height 240 mm ■ swivel spout ■ ceramic internal upper parts 1/2" ■ pop-up waste 1 1/4" ■ recommended: 2x 649.15.530 - copper tube 300 mm 	A	B	C	D	E
			739,-	962,-	1.154,-	1.232,-	1.574,-
<u>Griffvariante Handle alternative</u>			F	G	H	I	L
	109.30.305 Waschtisch 3-Loch Batterie 1/2" <ul style="list-style-type: none"> ■ mit Hebelgriffen, weiß 	Washbasin 3-hole mixer 1/2" <ul style="list-style-type: none"> ■ with lever handles, white 	1.464,-	1.194,-	1.512,-	1.895,-	2.769,-
			<u>Griffvariante Handle alternative</u>				
	109.30.308 Waschtisch 3-Loch Batterie 1/2" <ul style="list-style-type: none"> ■ mit Porzellangriffen und Krakeleé 	Washbasin 3-hole mixer 1/2" <ul style="list-style-type: none"> ■ with porcelain handles and crackleé 					
			<u>Griffvariante Handle alternative</u>				
	109.30.304 Waschtisch 3-Loch Batterie 1/2" <ul style="list-style-type: none"> ■ mit Hebelgriffen, Metall 	Washbasin 3-hole mixer 1/2" <ul style="list-style-type: none"> ■ with lever handles, metal 					
			<u>Griffvariante Handle alternative</u>				
	109.10.300 Waschtisch 1-Loch Batterie 1/2" <ul style="list-style-type: none"> ■ mit Kreuzgriffen ■ Ausladung 165 mm; Höhe 236 mm ■ Auslauf schwenkbar, Exzentergarnitur ■ mit keramischen Oberteilen 1/2" ■ 2 Kupferrohre M10x1 x 400 mm 	Washbasin 1-hole mixer 1/2" <ul style="list-style-type: none"> ■ with cross handles ■ projection 165 mm; height 236 mm ■ swivel spout, pop-up waste ■ ceramic internal upper parts 1/2" ■ 2 copper tubes M10x1 x 400 mm 	A	B	C	D	E
			512,-	712,-	856,-	924,-	1.246,-
<u>Griffvariante Handle alternative</u>			F	G	H	I	L
	109.10.305 Waschtisch 1-Loch Batterie 1/2" <ul style="list-style-type: none"> ■ mit Hebelgriffen, weiß 	Washbasin 1-hole mixer 1/2" <ul style="list-style-type: none"> ■ with lever handles, white 	1.108,-	1.022,-	1.294,-	1.426,-	2.449,-
			<u>Griffvariante Handle alternative</u>				
	109.10.308 Waschtisch 1-Loch Batterie 1/2" <ul style="list-style-type: none"> ■ mit Porzellangriffen und Krakeleé 	Washbasin 1-hole mixer 1/2" <ul style="list-style-type: none"> ■ with porcelain handles and crackleé 					
			<u>Griffvariante Handle alternative</u>				
	109.10.304 Waschtisch 1-Loch Batterie 1/2" <ul style="list-style-type: none"> ■ mit Hebelgriffen, Metall 	Washbasin 1-hole mixer 1/2" <ul style="list-style-type: none"> ■ with lever handles, metal 					
			<u>Griffvariante Handle alternative</u>				
	109.10.333 Waschtisch 1-Hand Batterie <ul style="list-style-type: none"> ■ mit Hebelgriff, weiß ■ Ausladung 165 mm; Höhe 240 mm ■ Auslauf schwenkbar, Exzentergarnitur ■ Kartusche mit keramischen Scheiben ■ 2 Kupferrohre M10x1 x 400 mm 	Single lever washbasin mixer <ul style="list-style-type: none"> ■ with lever handle, white ■ spout projection 165 mm; height 240 mm ■ swivel spout, pop-up waste ■ cartridge with ceramic discs ■ 2 copper tubes M10x1 x 400 mm 	A	B	C	D	E
			524,-	738,-	832,-	946,-	1.282,-
<u>Griffvariante Handle alternative</u>			F	G	H	I	L
	109.10.368 Waschtisch 1-Hand Batterie <ul style="list-style-type: none"> ■ mit Porzellangriff und Krakeleé 	Single lever washbasin mixer <ul style="list-style-type: none"> ■ with porcelain handle and crackleé 	1.132,-	1.049,-	1.298,-	1.446,-	2.456,-
			<u>Griffvariante Handle alternative</u>				
	109.10.364 Waschtisch 1-Hand Batterie <ul style="list-style-type: none"> ■ mit Hebelgriff, Metall 	Single lever washbasin mixer <ul style="list-style-type: none"> ■ with lever handle, metal 					
			<u>Griffvariante Handle alternative</u>				

Maßzeichnungen unter www.joerger.de - Menü SERVICE.
 Technical specifications under www.joerger.de - menu SERVICE.

A chrom chrome	[.000]	E platin matt platinum matt	[.066]
B silbernickel polished nickel	[.035]	F nerz matt milk matt	[.096]
C nerz milk	[.095]	G schwarz-matt black matt	[.092]
C nickel matt satin nickel	[.036]	G weiß-matt white matt	[.052]
D edelmessing sunshine	[.040]	H bronze bronze	[.011]
D platin platinum	[.065]	I gold gold	[.020]
E edelmess.matt sunshine matt	[.041]	L roségold rosegold	[.022]
E gold matt gold matt	[.021]	L roségold matt rosegold matt	[.023]

Waschtisch Batterien mit Erhöhung | Washbasin mixer with extension



- | | |
|--|--|
| <p>109.10.332 Waschtisch 1-Hand Batterie</p> <ul style="list-style-type: none"> ■ mit Rohrverlängerung 140 mm ■ mit Hebelgriff, weiß ■ Ausladung 165 mm
Gesamthöhe 380 mm ■ Auslauf schwenkbar, Exzentergarnitur ■ Kartusche mit keramischen Scheiben ■ 2 Druckschläuche M10x1 x 600 mm | <p>Single lever washbasin mixer</p> <ul style="list-style-type: none"> ■ with body extension 140 mm ■ with lever handle, white ■ spout projection 165 mm
height 380 mm ■ swivel spout, pop-up waste ■ cartridge with ceramic discs ■ 2 pressure hoses M10x1 x 600 mm |
|--|--|

A	B	C	D	E
698,-	978,-	1.074,-	1.209,-	1.659,-
F	G	H	I	L
1.425,-	1.509,-	1.769,-	1.926,-	3.386,-

Griffvariante | Handle alternative



- | | |
|---|--|
| <p>109.10.335 Waschtisch 1-Hand Batterie</p> <ul style="list-style-type: none"> ■ mit Rohrverlängerung 140 mm ■ mit Porzellanriff und Krakeelé | <p>Single lever washbasin mixer</p> <ul style="list-style-type: none"> ■ with body extension 140 mm ■ with porcelain handle and crackleé |
|---|--|

Griffvariante | Handle alternative



- | | |
|---|--|
| <p>109.10.363 Waschtisch 1-Hand Batterie</p> <ul style="list-style-type: none"> ■ mit Rohrverlängerung 140 mm ■ mit Hebelgriff, Metall | <p>Single lever washbasin mixer</p> <ul style="list-style-type: none"> ■ with body extension 140 mm ■ with lever handle, metal |
|---|--|



- | | |
|--|--|
| <p>109.10.337 Waschtisch 1-Hand Batterie</p> <ul style="list-style-type: none"> ■ mit Rohrverlängerung 100 mm ■ mit Hebelgriff, weiß ■ Ausladung 165 mm
Gesamthöhe 340 mm ■ Auslauf schwenkbar, Exzentergarnitur ■ Kartusche mit keramischen Scheiben ■ 2 Druckschläuche M10x1 x 600 mm | <p>Single lever washbasin mixer</p> <ul style="list-style-type: none"> ■ with body extension 100 mm ■ with lever handle, white ■ spout projection 165 mm
height 340 mm ■ swivel spout, pop-up waste ■ cartridge with ceramic discs ■ 2 pressure hoses M10x1 x 600 mm |
|--|--|

A	B	C	D	E
694,-	967,-	1.062,-	1.198,-	1.648,-
F	G	H	I	L
1.415,-	1.486,-	1.750,-	1.914,-	3.366,-

Griffvariante | Handle alternative



- | | |
|---|--|
| <p>109.10.338 Waschtisch 1-Hand Batterie</p> <ul style="list-style-type: none"> ■ mit Rohrverlängerung 100 mm ■ mit Porzellanriff und Krakeelé | <p>Single lever washbasin mixer</p> <ul style="list-style-type: none"> ■ with body extension 100 mm ■ with porcelain handle and crackleé |
|---|--|

Griffvariante | Handle alternative



- | | |
|---|--|
| <p>109.10.367 Waschtisch 1-Hand Batterie</p> <ul style="list-style-type: none"> ■ mit Rohrverlängerung 100 mm ■ mit Hebelgriff, Metall | <p>Single lever washbasin mixer</p> <ul style="list-style-type: none"> ■ with body extension 100 mm ■ with lever handle, metal |
|---|--|



- | | |
|---|---|
| <p>109.10.400 Standventil 1/2"</p> <ul style="list-style-type: none"> ■ mit Kreuzgriff ■ Ausladung 105 mm; Höhe 95 mm ■ ohne Perlator | <p>Deck mount tap 1/2"</p> <ul style="list-style-type: none"> ■ with cross handle ■ spout projection 105 mm;
height 95 mm ■ no aerator |
|---|---|

A	B	C	D	E
294,-	356,-	479,-	638,-	834,-
F	G	H	I	L
798,-	628,-	629,-	992,-	846,-

Griffvariante | Handle alternative



- | | |
|--|---|
| <p>109.10.405 Standventil 1/2"</p> <ul style="list-style-type: none"> ■ mit Hebelgriff, weiß | <p>Deck mount tap 1/2"</p> <ul style="list-style-type: none"> ■ with lever handle, white |
|--|---|

Griffvariante | Handle alternative



- | | |
|--|---|
| <p>109.10.408 Standventil 1/2"</p> <ul style="list-style-type: none"> ■ mit Porzellanriff und Krakeelé | <p>Deck mount tap 1/2"</p> <ul style="list-style-type: none"> ■ with porcelain handle and crackleé |
|--|---|





Griffvariante | Handle alternative



- | | |
|--|---|
| <p>109.10.404 Standventil 1/2"</p> <ul style="list-style-type: none"> ■ mit Hebelgriff, Metall | <p>Deck mount tap 1/2"</p> <ul style="list-style-type: none"> ■ with lever handle, metal |
|--|---|

Maßzeichnungen unter www.joerger.de - Menü SERVICE.
 Technical specifications under www.joerger.de - menu SERVICE.

A chrom chrome	[.000]	E platin matt platinum matt	[.066]
B silbernickel polished nickel	[.035]	F nerz matt mink matt	[.096]
C nerz mink	[.095]	G schwarz-matt black matt	[.092]
C nickel matt satin nickel	[.036]	G weiß-matt white matt	[.052]
D edelmessing sunshine	[.040]	H bronze bronze	[.011]
D platin platinum	[.065]	I gold gold	[.020]
E edelmess.matt sunshine matt	[.041]	L roségold rosegold	[.022]
E gold matt gold matt	[.021]	L roségold matt rosegold matt	[.023]

	109.30.360 Wand-Waschtisch 3-Loch Batterie 1/2", Fertigmontageset	Wall washbasin 3-hole mixer 1/2" assembly set	A	B	C	D	E
	<ul style="list-style-type: none"> mit Kreuzgriffen Wand-Auslauf, Ausladung 212 - 224 mm Griff, Hülse, Schubrosette Oberteile 1/2", keramische Scheiben 	<ul style="list-style-type: none"> with cross handles wall spout, projection 212 - 224 mm design handle, adjustable escutcheons cartridges 1/2", with ceramic discs 	689,-	952,-	1.069,-	1.139,-	1.431,-
<u>Griffvariante Handle alternative</u>			F	G	H	I	L
	109.30.365 Wand-Waschtisch 3-Loch Batterie 1/2", Fertigmontageset	Wall washbasin 3-hole mixer 1/2" assembly set					
	<ul style="list-style-type: none"> mit Hebelgriffen, weiß 	<ul style="list-style-type: none"> with lever handles, white 	1.299,-	1.146,-	1.398,-	1.639,-	2.619,-
<u>Griffvariante Handle alternative</u>							
	109.30.368 Wand-Waschtisch 3-Loch Batterie 1/2", Fertigmontageset	Wall washbasin 3-hole mixer 1/2" assembly set					
	<ul style="list-style-type: none"> mit Porzellangriffen und Krakeelé 	<ul style="list-style-type: none"> with porcelain handles and crackleé 					
<u>Griffvariante Handle alternative</u>							
	109.30.364 Wand-Waschtisch 3-Loch Batterie 1/2", Fertigmontageset	Wall washbasin 3-hole mixer 1/2" assembly set					
	<ul style="list-style-type: none"> mit Hebelgriffen, Metall 	<ul style="list-style-type: none"> with lever handles, metal 					
<u>Benötigt Required</u>			A				
	649.30.380 Wand-Waschtisch 3-Loch Batterie 1/2", Einbaukörper	Wall washbasin 3-hole mixer 1/2" concealed body	296,-				
	<ul style="list-style-type: none"> 2 Anschlüsse, Stichmaß 204 mm zu Fertigmontageset 109.30.360, 109.30.365, 109.30.366 und 109.30.364 	<ul style="list-style-type: none"> 2 connections, center distance 204 mm for assembly set 109.30.360, 109.30.365, 109.30.366 and 109.30.364 					

Bidet Batterien | Bidet mixer

	109.30.100 Bidet 3-Loch Batterie 1/2"	Bidet 3-hole mixer 1/2"	A	B	C	D	E
	<ul style="list-style-type: none"> mit Kreuzgriffen Ausladung 145 mm; Höhe 150 mm Auslauf schwenkbar mit keramischen Oberteilen 1/2" Exzentergarnitur 1 1/4" empfohlen: 2x 649.15.530 - Kupferrohr 300 mm 	<ul style="list-style-type: none"> with cross handles spout projection 145 mm; height 150 mm swivel spout ceramic internal upper parts 1/2" pop-up waste 1 1/4" recommended: 2x 649.15.530 - copper tube 300 mm 	916,-	1.192,-	1.299,-	1.473,-	1.726,-
<u>Griffvariante Handle alternative</u>			F	G	H	I	L
	109.30.105 Bidet 3-Loch Batterie 1/2"	Bidet 3-hole mixer 1/2"					
	<ul style="list-style-type: none"> mit Hebelgriffen, weiß 	<ul style="list-style-type: none"> with lever handles, white 	1.624,-	1.299,-	1.579,-	2.034,-	2.949,-
<u>Griffvariante Handle alternative</u>							
	109.30.108 Bidet 3-Loch Batterie 1/2"	Bidet 3-hole mixer 1/2"					
	<ul style="list-style-type: none"> mit Porzellangriffen und Krakeelé 	<ul style="list-style-type: none"> with porcelain handles and crackleé 					
<u>Griffvariante Handle alternative</u>							
	109.30.104 Bidet 3-Loch Batterie 1/2"	Bidet 3-hole mixer 1/2"					
	<ul style="list-style-type: none"> mit Hebelgriffen, Metall 	<ul style="list-style-type: none"> with lever handles, metal 					

Maßzeichnungen unter www.joerger.de - Menü SERVICE.
 Technical specifications under www.joerger.de - menu SERVICE.

A chrom chrome	[.000]	E platin matt platinum matt	[.066]
B silbernickel polished nickel	[.035]	F nerz matt milk matt	[.096]
C nerz milk	[.095]	G schwarz-matt black matt	[.092]
C nickel matt satin nickel	[.036]	G weiß-matt white matt	[.052]
D edelmessing sunshine	[.040]	H bronze bronze	[.011]
D platin platinum	[.065]	I gold gold	[.020]
E edelmess.matt sunshine matt	[.041]	L roségold rosegold	[.022]
E gold matt gold matt	[.021]	L roségold matt rosegold matt	[.023]



109.10.111 Bidet 1-Hand Batterie
 ■ mit Hebelgriff, weiß
 ■ Ausladung 145 mm; Höhe 205 mm
 ■ Auslauf schwenkbar
 ■ Kartusche mit keramischen Scheiben
 ■ Exzentergarnitur 1 ¼"
 ■ 2 Kupferrohre M10x1 x 400 mm

Single lever bidet mixer
 ■ with lever handle, white
 ■ spout projection 145 mm; height 205 mm
 ■ swivel spout
 ■ cartridge with ceramic discs
 ■ pop-up waste 1 ¼"
 ■ 2 copper tubes M10x1 x 400 mm

A	B	C	D	E
612,-	812,-	933,-	1.055,-	1.410,-
F	G	H	I	L
1.286,-	1.092,-	1.362,-	1.518,-	2.579,-

Griffvariante | Handle alternative



109.10.118 Waschtisch 1-Loch Batterie ½"
 ■ mit Porzellangriff und Krakeelé

Washbasin 1-hole mixer ½"
 ■ with porcelain handle and crackleé

Griffvariante | Handle alternative



109.10.114 Waschtisch 1-Loch Batterie ½"
 ■ mit Hebelgriff, Metall

Washbasin 1-hole mixer ½"
 ■ with lever handle, metal



109.10.100 Bidet 1-Loch Batterie ½"
 ■ mit Kreuzgriffen
 ■ Ausladung 145 mm; Höhe 150 mm
 ■ Auslauf schwenkbar
 ■ mit keramischen Oberteilen ½"
 ■ Exzentergarnitur 1 ¼"
 ■ 2 Kupferrohre M10x1 x 400 mm

Bidet 1-hole mixer ½"
 ■ with cross handles
 ■ spout projection 145 mm; height 150 mm
 ■ swivel spout
 ■ ceramic internal upper parts ½"
 ■ pop-up waste 1 ¼"
 ■ 2 copper tubes M10x1 x 400 mm

A	B	C	D	E
608,-	783,-	929,-	1.049,-	1.308,-
F	G	H	I	L
1.224,-	1.072,-	1.359,-	1.529,-	2.569,-

Griffvariante | Handle alternative



109.10.105 Bidet 1-Loch Batterie ½"
 ■ mit Hebelgriffen, weiß

Bidet 1-hole mixer ½"
 ■ with lever handles, white

Griffvariante | Handle alternative



109.10.108 Bidet 1-Loch Batterie ½"
 ■ mit Porzellangriffen und Krakeelé

Bidet 1-hole mixer ½"
 ■ with porcelain handles and crackleé

Griffvariante | Handle alternative



109.10.104 Bidet 1-Loch Batterie ½"
 ■ mit Hebelgriffen, Metall

Bidet 1-hole mixer ½"
 ■ with lever handles, metal

Zubehör für Waschtisch- und Bidet-Batterien | Supplies for washbasin and bidet mixer



109.12.100 Eckventil ½"
 ■ Fettkammer-Innenoberteil ½"
 ■ Quetschverschraubung
 ■ Schubrosette

Angle valve ½"
 ■ cartridge ½"
 ■ compression joint
 ■ escutcheon

A	B	C	D	E
229,-	268,-	289,-	312,-	364,-
F	G	H	I	L
338,-	295,-	345,-	424,-	712,-

Griffvariante | Handle alternative



109.12.105 Eckventil ½"
 ■ mit Hebelgriffen, weiß

Angle valve ½"
 ■ with lever handles, white

Griffvariante | Handle alternative



109.12.108 Eckventil ½"
 ■ mit Hebelgriffen, weiß

Angle valve ½"
 ■ with lever handles, white

Griffvariante | Handle alternative







109.12.104 Eckventil ½"
 ■ mit Hebelgriffen, Metall





Angle valve ½"
 ■ with lever handles, metal

Maßzeichnungen unter www.joerger.de - Menü SERVICE.
 Technical specifications under www.joerger.de - menu SERVICE.

A chrom chrome	[.000]	E platin matt platinum matt	[.066]
B silbernickel polished nickel	[.035]	F nerz matt mink matt	[.096]
C nerz mink	[.095]	G schwarz-matt black matt	[.092]
C nickel matt satin nickel	[.036]	G weiß-matt white matt	[.052]
D edelmessing sunshine	[.040]	H bronze bronze	[.011]
D platin platinum	[.065]	I gold gold	[.020]
E edelmess.matt sunshine matt	[.041]	L roségold rosegold	[.022]
E gold matt gold matt	[.021]	L roségold matt rosegold matt	[.023]

		A	B	C	D	E	
	649.15.530 Kupferrohr, 300 mm ■ mit Bördel, für Quetschverschraubung	Copper tube, 300 mm ■ with flange, for compression joint	15,-	38,-	55,-	62,-	74,-
	<i>Variante Alternative</i>		F	G	H	I	L
			69,-	75,-	94,-	112,-	169,-
	649.15.550 Kupferrohr, 500 mm ■ mit Bördel, für Quetschverschraubung	Copper tube, 500 mm ■ with flange, for compression joint	20,-	58,-	77,-	87,-	102,-
	<i>Variante Alternative</i>		F	G	H	I	L
			97,-	77,-	96,-	134,-	219,-
	649.15.340 Waschtisch-Tassensiphon 1 ¼" ■ schwere Ausführung ■ Rosette ■ Abgangsrohr ø 32 mm ■ Tauchrohrlänge 165 mm	Washbasin cupped siphon trap 1 ¼" ■ heavy brass ■ escutcheon ■ outlet tube ø 32 mm ■ dip pipe 165 mm	195,-	296,-	368,-	429,-	568,-
	<i>Variante Alternative</i>		F	G	H	I	L
			498,-	378,-	539,-	686,-	832,-
	649.15.330 Bidet-Tassensiphon 1 ¼" ■ Rosette ■ Abgangsrohr ø 32 mm	Bidet cupped siphon trap 1 ¼" ■ escutcheon ■ outlet tube ø 32 mm	98,-	166,-	276,-	332,-	472,-
	<i>Variante Alternative</i>		F	G	H	I	L
			399,-	364,-	508,-	648,-	796,-

Badewanne, Stand-Batterien | Bath tub mixer sets, deck mount

		A	B	C	D	E	
	109.40.100 4-Loch Wannenfüll- und Brausebatterie ½", für Standmontage ■ mit Kreuzgriffen ■ Ausladung 206 mm; Höhe 252 mm ■ 2 Seitenrandventile mit keramischen Oberteilen ½" ■ Metall-Brauseschlauch 2000 mm ■ Metall-Handbrause mit Anti-Kalk-System und Rückflussverhinderer	Tub/shower mixer set ½" deck mount ■ with cross handles ■ spout projection 206 mm; height 252 mm ■ 2 side valves, ceramic internal upper parts ½" ■ metal shower hose 2000 mm ■ metal hand shower with anticalc. system and backflow preventer	1.694,-	1.996,-	2.312,-	2.599,-	3.062,-
	<i>Griffvariante Handle alternative</i>		F	G	H	I	L
			2.888,-	2.256,-	2.708,-	3.506,-	3.939,-
	109.40.105 4-Loch Wannenfüll- und Brausebatterie ½", für Standmontage ■ mit Hebelgriffen, weiß	Tub/shower mixer set ½" deck mount ■ with lever handles, white					
	<i>Griffvariante Handle alternative</i>						
	109.40.108 4-Loch Wannenfüll- und Brausebatterie ½", für Standmontage ■ mit Porzellangriffen und Krakeleé	Tub/shower mixer set ½" deck mount ■ with porcelain handles and crackleé					
	<i>Griffvariante Handle alternative</i>						
	109.40.104 4-Loch Wannenfüll- und Brausebatterie ½", für Standmontage ■ mit Hebelgriffen, Metall	Tub/shower mixer set ½" deck mount ■ with lever handles, metal					
	<i>Griffvariante Handle alternative</i>						
	649.40.160 Montageplatte, komplett ■ für 4-Loch Armaturen ■ Druckschläuche ½" x ½" x 600 mm ■ empfohlen: Schlauchkastensystem siehe Kapitel "Serienübergreifendes"	Assembly plate, complete ■ for deck mounted tub/shower mixer ■ pressure hoses ½" x ½" x 600 mm ■ recommended: system with hose box see chapter "universal products"	A				
	<i>Empfohlen Recommended</i>						
			308,-				



A chrom chrome	[.000]	E platin matt platinum matt	[.066]
B silbernickel polished nickel	[.035]	F nerz matt milk matt	[.096]
C nerz milk	[.095]	G schwarz-matt black matt	[.092]
C nickel matt satin nickel	[.036]	G weiß-matt white matt	[.052]
D edelmessing sunshine	[.040]	H bronze bronze	[.011]
D platin platinum	[.065]	I gold gold	[.020]
E edelmess.matt sunshine matt	[.041]	L roségold rosegold	[.022]
E gold matt gold matt	[.021]	L roségold matt rosegold matt	[.023]

	109.40.150 4-Loch Wannenrandkombi ½“ <ul style="list-style-type: none"> mit Kreuzgriffen für Ab- und Überlaufgarnitur mit Wanneneinlauf, ohne Rohrunterbrecher Seitenrandventile, 2-Wege Umstellung Metall-Brauseschlauch 2000 mm Metall-Handbrause mit Anti-Kalk-System und Rückflussverhinderer 	tub/shower combination ½“ <ul style="list-style-type: none"> with cross handles for waste and overflow set with bath tub filler spout, without pipe interrupter side valves, 2-position diverter metal shower hose 2000 mm metal hand shower with anticalc. system and backflow preventer 	<table border="1"> <thead> <tr> <th>A</th> <th>B</th> <th>C</th> <th>D</th> <th>E</th> </tr> </thead> <tbody> <tr> <td>1.356,-</td> <td>1.632,-</td> <td>2.122,-</td> <td>2.389,-</td> <td>2.638,-</td> </tr> </tbody> </table>	A	B	C	D	E	1.356,-	1.632,-	2.122,-	2.389,-	2.638,-
	A	B	C	D	E								
1.356,-	1.632,-	2.122,-	2.389,-	2.638,-									
Griffvariante Handle alternative 109.40.155 4-Loch Wannenrandkombi ½“ <ul style="list-style-type: none"> mit Hebelgriffen, weiß 	tub/shower combination ½“ <ul style="list-style-type: none"> with lever handles, white 	<table border="1"> <thead> <tr> <th>F</th> <th>G</th> <th>H</th> <th>I</th> <th>L</th> </tr> </thead> <tbody> <tr> <td>2.537,-</td> <td>2.069,-</td> <td>2.456,-</td> <td>2.729,-</td> <td>3.198,-</td> </tr> </tbody> </table>	F	G	H	I	L	2.537,-	2.069,-	2.456,-	2.729,-	3.198,-	
F	G	H	I	L									
2.537,-	2.069,-	2.456,-	2.729,-	3.198,-									

	Griffvariante Handle alternative 109.40.158 4-Loch Wannenrandkombi ½“ <ul style="list-style-type: none"> mit Porzellangriffen und Krakeleé 	tub/shower combination ½“ <ul style="list-style-type: none"> with porcelain handles and crackleé 	
	Griffvariante Handle alternative 109.40.154 4-Loch Wannenrandkombi ½“ <ul style="list-style-type: none"> mit Hebelgriffen, Metall 	tub/shower combination ½“ <ul style="list-style-type: none"> with lever handles, metal 	

	Empfohlen Recommended 649.40.160 Montageplatte, komplett <ul style="list-style-type: none"> für 4-Loch Armaturen Druckschläuche ½" x ½" x 600 mm empfohlen: Schlauchkastensystem siehe Kapitel "Serienübergreifendes" 	Assembly plate, complete <ul style="list-style-type: none"> for deck mounted tub/shower mixer pressure hoses ½"x ½" x 600 mm recommended: system with hose box see chapter "universal products" 	<table border="1"> <thead> <tr> <th>A</th> <th>B</th> <th>C</th> <th>D</th> <th>E</th> </tr> </thead> <tbody> <tr> <td>308,-</td> <td></td> <td></td> <td></td> <td></td> </tr> </tbody> </table>	A	B	C	D	E	308,-				
	A	B	C	D	E								
308,-													

Badewanne, Aufputz-Batterien | Bath tub mixer sets, exposed

	109.20.100 Aufputz Wannenfüll- und Brausebatterie ½“, mit Garnitur <ul style="list-style-type: none"> mit Kreuzgriffen Ausladung 145 mm 2 keramische Oberteile ½“ Metall-Handbrause mit Anti-Kalk-System und Rückflussverhinderer Metall-Brauseschlauch 1500 mm 	Exposed tub/shower mixer ½“, incl. shower set <ul style="list-style-type: none"> with cross handles spout projection 145 mm 2 ceramic internal upper parts ½“ metal hand shower with anticalc. system and backflow preventer metal shower hose 1500 mm 	<table border="1"> <thead> <tr> <th>A</th> <th>B</th> <th>C</th> <th>D</th> <th>E</th> </tr> </thead> <tbody> <tr> <td>876,-</td> <td>1.124,-</td> <td>1.524,-</td> <td>1.715,-</td> <td>2.019,-</td> </tr> </tbody> </table>	A	B	C	D	E	876,-	1.124,-	1.524,-	1.715,-	2.019,-
	A	B	C	D	E								
876,-	1.124,-	1.524,-	1.715,-	2.019,-									
Griffvariante Handle alternative 109.20.105 Aufputz Wannenfüll- und Brausebatterie ½“, mit Garnitur <ul style="list-style-type: none"> mit Hebelgriffen, weiß 	Exposed tub/shower mixer ½“, incl. shower set <ul style="list-style-type: none"> with lever handles, white 	<table border="1"> <thead> <tr> <th>F</th> <th>G</th> <th>H</th> <th>I</th> <th>L</th> </tr> </thead> <tbody> <tr> <td>1.869,-</td> <td>1.486,-</td> <td>1.796,-</td> <td>2.299,-</td> <td>2.996,-</td> </tr> </tbody> </table>	F	G	H	I	L	1.869,-	1.486,-	1.796,-	2.299,-	2.996,-	
F	G	H	I	L									
1.869,-	1.486,-	1.796,-	2.299,-	2.996,-									
	Griffvariante Handle alternative 109.20.108 Aufputz Wannenfüll- und Brausebatterie ½“, mit Garnitur <ul style="list-style-type: none"> mit Porzellangriffen und Krakeleé 	Exposed tub/shower mixer ½“, incl. shower set <ul style="list-style-type: none"> with porcelain handles and crackleé 											
	Griffvariante Handle alternative 109.20.104 Aufputz Wannenfüll- und Brausebatterie ½“, mit Garnitur <ul style="list-style-type: none"> mit Hebelgriffen, Metall 	Exposed tub/shower mixer ½“, incl. shower set <ul style="list-style-type: none"> with lever handles, metal 											

Maßzeichnungen unter www.joerger.de - Menü SERVICE.
 Technical specifications under www.joerger.de - menu SERVICE.

A chrom chrome	[.000]	E platin matt platinum matt	[.066]
B silbernickel polished nickel	[.035]	F nerz matt mink matt	[.096]
C nerz mink	[.095]	G schwarz-matt black matt	[.092]
C nickel matt satin nickel	[.036]	G weiß-matt white matt	[.052]
D edelmessing sunshine	[.040]	H bronze bronze	[.011]
D platin platinum	[.065]	I gold gold	[.020]
E edelmess.matt sunshine matt	[.041]	L roségold rosegold	[.022]
E gold matt gold matt	[.021]	L roségold matt rosegold matt	[.023]

Badewanne, Aufputz-Batterien | Bath tub mixer sets, exposed



109.20.140 Aufputz Wannenfüll- und Brausebatterie 1/2", mit Garnitur

- mit Kreuzgriffen
- Ausladung mit Steigrohren 182 mm
- 2 keramische Oberteile 1/2"
- Metall-Handbrause mit Anti-Kalk-System und Rückflussverhinderer
- Metall-Brauseschlauch 1500 mm

Exposed tub/shower mixer 1/2", incl. shower set

- with cross handles
- spout projection with supply pipes 182 mm
- 2 ceramic internal upper parts 1/2"
- metal hand shower with anticalc. system and backflow preventer
- metal shower hose 1500 mm

A	B	C	D	E
824,-	1.055,-	1.429,-	1.612,-	1.899,-
F	G	H	I	L
1.752,-	1.397,-	1.688,-	2.168,-	2.936,-

Griffvariante | Handle alternative



109.20.145 Aufputz Wannenfüll- und Brausebatterie 1/2", mit Garnitur

- mit Hebelgriffen, weiß

Exposed tub/shower mixer 1/2", incl. shower set

- with lever handles, white

Griffvariante | Handle alternative



109.20.148 Aufputz Wannenfüll- und Brausebatterie 1/2", mit Garnitur

- mit Porzellangriffen und Krakeleé

Exposed tub/shower mixer 1/2", incl. shower set

- with porcelain handles and crackleé

Griffvariante | Handle alternative



109.20.144 Aufputz Wannenfüll- und Brausebatterie 1/2", mit Garnitur

- mit Hebelgriffen, Metall

Exposed tub/shower mixer 1/2", incl. shower set

- with lever handles, metal

Empfohlen | Recommended

109.15.260 Wasserzufuhrstandrohre 1/2"

- 2 Stück
- in Boden einzuschrauben
- inkl. Winkelstück zum Anschluß der Wannenfüll- und Brausebatterie
- Höhe 775 - 800 mm
- für 109.20.100, 109.20.105, 109.20.106 und 109.20.104

Water supply pipes 1/2"

- 2 pieces
- floor installation
- incl. angle for connecting tub/shower mixer
- height 775 - 800 mm
- for 109.20.100, 109.20.105, 109.20.106 and 109.20.104

A	B	C	D	E
888,-	1.282,-	1.672,-	1.882,-	2.219,-
F	G	H	I	L
2.095,-	1.632,-	1.952,-	2.525,-	3.488,-

Empfohlen | Recommended

109.10.970 Bausatz-Vormontage

- Bodenplatte mit Befestigungsset
- für Wasserzufuhrstandrohre 109.15.260



Assembly set for pre-installation

- joint plate with fixing set
- for water supply pipes 109.15.260

A	B	C	D	E
459,-				



109.20.500 Aufputz 1-Hand Wannenfüll- und Brausebatterie 1/2", mit Garnitur

- mit Hebelgriff, weiß
- Ausladung 175 mm
- Kartusche mit keramischen Scheiben
- Metall-Handbrause mit Anti-Kalk-System und Rückflussverhinderer
- Metall-Brauseschlauch 1500 mm

Single lever exposed tub/shower mixer 1/2", incl. shower set

- with lever handles, white
- spout projection 175 mm
- cartridge with ceramic discs
- metal hand shower with anticalc. system and backflow preventer
- metal shower hose 1500 mm

A	B	C	D	E
842,-	1.078,-	1.459,-	1.648,-	1.939,-
F	G	H	I	L
1.789,-	1.428,-	1.629,-	2.216,-	2.998,-

Griffvariante | Handle alternative



109.20.508 Aufputz Wannenfüll- und Brausebatterie 1/2", mit Garnitur

- mit Porzellangriff und Krakeleé

Exposed tub/shower mixer 1/2", incl. shower set

- with porcelain handle and crackleé

Griffvariante | Handle alternative



109.20.504 Aufputz Wannenfüll- und Brausebatterie 1/2", mit Garnitur

- mit Hebelgriff, Metall





Exposed tub/shower mixer 1/2", incl. shower set

- with lever handle, metal



Maßzeichnungen unter www.joerger.de - Menü SERVICE.
 Technical specifications under www.joerger.de - menu SERVICE.

A chrom chrome	[.000]	E platin matt platinum matt	[.066]
B silbernickel polished nickel	[.035]	F nerz matt milk matt	[.096]
C nerz milk	[.095]	G schwarz-matt black matt	[.092]
C nickel matt satin nickel	[.036]	G weiß-matt white matt	[.052]
D edelmessing sunshine	[.040]	H bronze bronze	[.011]
D platin platinum	[.065]	I gold gold	[.020]
E edelmess.matt sunshine matt	[.041]	L roségold rosegold	[.022]
E gold matt gold matt	[.021]	L roségold matt rosegold matt	[.023]

109.20.39x – Aufputz Set mit Steigrohr | Exposed set with shower system





	649.13.920 Regenbrause ½", ø 200 mm <ul style="list-style-type: none"> ■ Ausführung ganz in Metall ■ mit Kugelgelenk ■ Anti-Kalk-System 	Rain shower head ½", ø 200 mm <ul style="list-style-type: none"> ■ full metal body ■ with ball joint ■ with anticalcareous system 	A	B	C	D	E
			260,-	619,-	824,-	895,-	1.268,-
			F	G	H	I	L
			1.085,-	821,-	1.098,-	1.389,-	2.189,-
<hr/>							
	649.20.810 Steigrohr, Umstellung, Wandarm <ul style="list-style-type: none"> ■ zum Anschluß an die Brausebatterie ■ Ausladung 595 - 615 mm 	Supply pipe, diverter, wall bracket <ul style="list-style-type: none"> ■ to connect the exposed shower mixer ■ projection 595 - 615 mm 	A	B	C	D	E
			1.029,-	1.315,-	1.849,-	2.072,-	2.889,-
			F	G	H	I	L
			2.560,-	2.052,-	2.760,-	3.247,-	3.624,-
<hr/>							
	Variante Alternative						
	649.20.830 Steigrohr, Umstellung, Wandarm <ul style="list-style-type: none"> ■ Ausladung 355 - 375 mm 	Supply pipe, diverter, wall bracket <ul style="list-style-type: none"> ■ projection 355 - 375 mm 	A	B	C	D	E
<hr/>							
	109.13.700 Brausegarnitur <ul style="list-style-type: none"> ■ Metall-Handbrause mit Anti-Kalk-System und Rückflussverhinderer ■ Metall-Brauseschlauch 1500 mm, beidseitig mit drehbarem Konus 	Shower combination <ul style="list-style-type: none"> ■ metal hand shower with anticalc. system and backflow preventer ■ metal shower hose 1500 mm, both sides with turning cone 	A	B	C	D	E
<hr/>							
			226,-	396,-	416,-	467,-	569,-
			F	G	H	I	L
			508,-	544,-	745,-	832,-	1.328,-
<hr/>							
	109.20.190 Aufputz-Wannenfüll- und Brausebatterie ½", ohne Garnitur <ul style="list-style-type: none"> ■ mit Kreuzgriffen ■ für Steigrohr, Ausladung 145 mm 	Exposed tub/shower mixer ½", without shower set <ul style="list-style-type: none"> ■ with cross handles ■ for supply pipe, projection 145 mm 	A	B	C	D	E
<hr/>							
			764,-	1.064,-	1.279,-	1.448,-	1.696,-
			F	G	H	I	L
			1.595,-	1.279,-	1.546,-	1.897,-	2.889,-
<hr/>							
	Griffvariante Handle alternative						
	109.20.195 Aufputz-Wannenfüll- und Brausebatterie ½", ohne Garnitur <ul style="list-style-type: none"> ■ mit Hebelgriffen, weiß 	Exposed tub/shower mixer ½", without shower set <ul style="list-style-type: none"> ■ with lever handles, white 	A	B	C	D	E
<hr/>							
			764,-	1.064,-	1.279,-	1.448,-	1.696,-
			F	G	H	I	L
			1.595,-	1.279,-	1.546,-	1.897,-	2.889,-
<hr/>							
	Griffvariante Handle alternative						
	109.20.198 Aufputz-Wannenfüll- und Brausebatterie ½", ohne Garnitur <ul style="list-style-type: none"> ■ mit Porzellangriffen und Krakeleé 	Exposed tub/shower mixer ½", without shower set <ul style="list-style-type: none"> ■ with porcelain handles and crackleé 	A	B	C	D	E
<hr/>							
			764,-	1.064,-	1.279,-	1.448,-	1.696,-
			F	G	H	I	L
			1.595,-	1.279,-	1.546,-	1.897,-	2.889,-
<hr/>							
	Griffvariante Handle alternative						
	109.20.194 Aufputz-Wannenfüll- und Brausebatterie ½", ohne Garnitur <ul style="list-style-type: none"> ■ mit Hebelgriffen, Metall 	Exposed tub/shower mixer ½", without shower set <ul style="list-style-type: none"> ■ with lever handles, metal 	A	B	C	D	E

Dusche, Aufputz-Batterien | Shower mixer sets, exposed





	109.20.600 1-Hand Brausebatterie ½" für Aufputzmontage <ul style="list-style-type: none"> ■ mit Hebelgriff, weiß ■ Keramik-Kartusche ■ Brauseabgang ½" ■ verdeckte S-Anschlüsse ½" x ¾" 	Single lever exposed shower mixer ½" <ul style="list-style-type: none"> ■ with lever handle, white ■ cartridge with ceramic discs ■ discharge ½" ■ concealed S-connections ½" x ¾" 	A	B	C	D	E
			589,-	723,-	915,-	1.035,-	1.214,-
			F	G	H	I	L
			1.168,-	915,-	1.118,-	1.386,-	2.089,-
<hr/>							
	Griffvariante Handle alternative						
	109.20.608 Aufputz-Wannenfüll- und Brausebatterie ½", ohne Garnitur <ul style="list-style-type: none"> ■ mit Porzellangriff und Krakeleé 	Exposed tub/shower mixer ½", without shower set <ul style="list-style-type: none"> ■ with porcelain handle and crackleé 	A	B	C	D	E
<hr/>							
			764,-	1.064,-	1.279,-	1.448,-	1.696,-
			F	G	H	I	L
			1.595,-	1.279,-	1.546,-	1.897,-	2.889,-
<hr/>							
	Griffvariante Handle alternative						
	109.20.604 Aufputz-Wannenfüll- und Brausebatterie ½", ohne Garnitur <ul style="list-style-type: none"> ■ mit Hebelgriff, Metall 	Exposed tub/shower mixer ½", without shower set <ul style="list-style-type: none"> ■ with lever handle, metal 	A	B	C	D	E

Maßzeichnungen unter www.joerger.de - Menü SERVICE.
 Technical specifications under www.joerger.de - menu SERVICE.

A chrom chrome	[.000]	E platin matt platinum matt	[.066]
B silbernickel polished nickel	[.035]	F nerz matt mink matt	[.096]
C nerz mink	[.095]	G schwarz-matt black matt	[.092]
C nickel matt satin nickel	[.036]	G weiß-matt white matt	[.052]
D edelmessing sunshine	[.040]	H bronze bronze	[.011]
D platin platinum	[.065]	I gold gold	[.020]
E edelmess.matt sunshine matt	[.041]	L roségold rosegold	[.022]
E gold matt gold matt	[.021]	L roségold matt rosegold matt	[.023]

	109.20.200 Brausebatterie 1/2" für Aufputzmontage	Exposed shower mixer 1/2"	A	B	C	D	E
	<ul style="list-style-type: none"> mit Kreuzgriffen 2 keramische Oberteile 1/2" Brauseabgang 1/2" verdeckte S-Anschlüsse 1/2" x 3/4" 	<ul style="list-style-type: none"> with cross handles 2 ceramic internal upper parts 1/2" discharge 1/2" concealed S-connections 1/2" x 3/4" 	397,-	533,-	596,-	672,-	824,-
<u>Griffvariante Handle alternative</u>			F	G	H	I	L
	109.20.205 Brausebatterie 1/2" für Aufputzmontage	Exposed shower mixer 1/2"	772,-	794,-	1.089,-	1.297,-	2.129,-
<u>Griffvariante Handle alternative</u>							
	109.20.208 Brausebatterie 1/2" für Aufputzmontage	Exposed shower mixer 1/2"					
<u>Griffvariante Handle alternative</u>							
	109.20.204 Brausebatterie 1/2" für Aufputzmontage	Exposed shower mixer 1/2"					
<u>Griffvariante Handle alternative</u>							

109.20.41x – Aufputz Set mit Steigrohr | Exposed set with shower system

	649.13.920 Regenbrause 1/2", ø 200 mm	Rain shower head 1/2", ø 200 mm	A	B	C	D	E	
	<ul style="list-style-type: none"> Ausführung ganz in Metall mit Kugelgelenk Anti-Kalk-System 	<ul style="list-style-type: none"> full metal body with ball joint with anticalcareous system 	260,-	619,-	824,-	895,-	1.268,-	
	<u>Griffvariante Handle alternative</u>			F	G	H	I	L
	649.20.280 Steigrohr, Umstellung, Wandarm	Supply pipe, diverter, wall bracket	589,-	932,-	1.198,-	1.362,-	1.741,-	
	<ul style="list-style-type: none"> zum Anschluß an die Brausebatterie Ausladung 360 - 380 mm in der Neigung und Höhe verstellbare Brausehalterung 	<ul style="list-style-type: none"> to connect the exposed shower mixer projection 360 - 380 mm fitting for handshower adjustable in height and inclination 	1.085,-	821,-	1.098,-	1.389,-	2.189,-	
<u>Griffvariante Handle alternative</u>								
109.13.700 Brausegarnitur	Shower combination	508,-	544,-	745,-	832,-	1.328,-		
<ul style="list-style-type: none"> Metall-Handbrause mit Anti-Kalk-System und Rückflussverhinderer Metall-Brauseschlauch 1500 mm, beidseitig mit drehbarem Konus 	<ul style="list-style-type: none"> metal hand shower with anticalc. system and backflow preventer metal shower hose 1500 mm, both sides with turning cone 							
<u>Griffvariante Handle alternative</u>								
109.20.210 Aufputz-Brausebatterie 1/2"	Exposed shower mixer 1/2"	397,-	533,-	596,-	672,-	824,-		
<ul style="list-style-type: none"> mit Kreuzgriffen für Steigrohr, Brauseabgang 3/4" 	<ul style="list-style-type: none"> with cross handles for supply pipe, discharge 3/4" 	F	G	H	I	L		
<u>Griffvariante Handle alternative</u>			772,-	794,-	1.089,-	1.297,-	2.129,-	
	109.20.215 Aufputz-Brausebatterie 1/2"	Exposed shower mixer 1/2"						
<u>Griffvariante Handle alternative</u>								
	109.20.218 Aufputz-Brausebatterie 1/2"	Exposed shower mixer 1/2"						
<u>Griffvariante Handle alternative</u>								
	109.20.214 Aufputz-Brausebatterie 1/2"	Exposed shower mixer 1/2"						
<u>Griffvariante Handle alternative</u>								

A chrom chrome	[.000]	E platin matt platinum matt	[.066]
B silbernickel polished nickel	[.035]	F nerz matt milk matt	[.096]
C nerz milk	[.095]	G schwarz-matt black matt	[.092]
C nickel matt satin nickel	[.036]	G weiß-matt white matt	[.052]
D edelmessing sunshine	[.040]	H bronze bronze	[.011]
D platin platinum	[.065]	I gold gold	[.020]
E edelmess.matt sunshine matt	[.041]	L roségold rosegold	[.022]
E gold matt gold matt	[.021]	L roségold matt rosegold matt	[.023]

	109.20.250 Brausethermostat 1/2" für Aufputzmontage	Exposed shower thermostat 1/2"	A	B	C	D	E
	<ul style="list-style-type: none"> mit Kreuzgriff Dehnstoff-Thermoelement Keramik-Innenoberteil 1/2" Brauseabgang 1/2" Sicherheitsperre bei 38° C 	<ul style="list-style-type: none"> with cross handle cartridge with thermoelement ceramic cartridge 1/2" discharge 1/2" heat scale and locking device at 38 °C 	929,-	1.262,-	1.399,-	1.499,-	2.029,-
			F	G	H	I	L
			1.815,-	1.476,-	1.819,-	2.275,-	2.678,-

	109.20.255 Brausethermostat 1/2" für Aufputzmontage	Exposed shower thermostat 1/2"
	<ul style="list-style-type: none"> mit Hebelgriff, weiß 	<ul style="list-style-type: none"> with lever handle, white

	109.20.258 Brausethermostat 1/2" für Aufputzmontage	Exposed shower thermostat 1/2"
	<ul style="list-style-type: none"> mit Porzellangriff und Krakeelé 	<ul style="list-style-type: none"> with porcelain handle and crackleé

	109.20.254 Brausethermostat 1/2" für Aufputzmontage	Exposed shower thermostat 1/2"
	<ul style="list-style-type: none"> mit Hebelgriff, Metall 	<ul style="list-style-type: none"> with lever handle, metal

109.20.46x – Aufputz Set mit Steigrohr | Exposed set with shower system

	649.13.920 Regenbrause 1/2", ø 200 mm	Rain shower head 1/2", ø 200 mm	A	B	C	D	E
	<ul style="list-style-type: none"> Ausführung ganz in Metall mit Kugelgelenk Anti-Kalk-System 	<ul style="list-style-type: none"> full metal body with ball joint with anticalcareous system 	260,-	619,-	824,-	895,-	1.268,-
			F	G	H	I	L
			1.085,-	821,-	1.098,-	1.389,-	2.189,-

	649.20.280 Steigrohr, Umstellung, Wandarm	Supply pipe, diverter, wall bracket	A	B	C	D	E
	<ul style="list-style-type: none"> zum Anschluß an die Brausebatterie Ausladung 360 - 380 mm in der Neigung und Höhe verstellbare Brausehalterung 	<ul style="list-style-type: none"> to connect the exposed shower mixer projection 360 - 380 mm fitting for handshower adjustable in height and inclination 	589,-	932,-	1.198,-	1.362,-	1.741,-
			F	G	H	I	L
			1.599,-	1.318,-	1.649,-	1.895,-	2.529,-

	109.13.700 Brausegarnitur	Shower combination	A	B	C	D	E
	<ul style="list-style-type: none"> Metall-Handbrause mit Anti-Kalk-System und Rückflussverhinderer Metall-Brauseschlauch 1500 mm, beidseitig mit drehbarem Konus 	<ul style="list-style-type: none"> metal hand shower with anticalc. system and backflow preventer metal shower hose 1500 mm, both sides with turning cone 	226,-	396,-	416,-	467,-	569,-
			F	G	H	I	L
			508,-	544,-	745,-	832,-	1.328,-

	109.20.260 Aufputz-Brausethermostat 1/2"	Exposed shower thermostat 1/2"	A	B	C	D	E
	<ul style="list-style-type: none"> mit Kreuzgriff für Steigrohr, Brauseabgang 3/4" 	<ul style="list-style-type: none"> with cross handle for supply pipe, discharge 3/4" 	977,-	1.310,-	1.447,-	1.547,-	2.077,-

	109.20.265 Aufputz-Brausethermostat 1/2"	Exposed shower thermostat 1/2"
	<ul style="list-style-type: none"> mit Hebelgriff, weiß 	<ul style="list-style-type: none"> with lever handle, white

	109.20.268 Aufputz-Brausethermostat 1/2"	Exposed shower thermostat 1/2"
	<ul style="list-style-type: none"> mit Porzellangriff und Krakeelé 	<ul style="list-style-type: none"> with porcelain handle and crackleé

	109.20.264 Aufputz-Brausethermostat 1/2"	Exposed shower thermostat 1/2"
	<ul style="list-style-type: none"> mit Hebelgriff, Metall 	<ul style="list-style-type: none"> with lever handle, metal

A chrom chrome	[.000]	E platin matt platinum matt	[.066]
B silbernickel polished nickel	[.035]	F nerz matt milk matt	[.096]
C nerz milk	[.095]	G schwarz-matt black matt	[.092]
C nickel matt satin nickel	[.036]	G weiß-matt white matt	[.052]
D edelmessing sunshine	[.040]	H bronze bronze	[.011]
D platin platinum	[.065]	I gold gold	[.020]
E edelmess.matt sunshine matt	[.041]	L roségold rosegold	[.022]
E gold matt gold matt	[.021]	L roségold matt rosegold matt	[.023]

Unterputz-Hebelmischer 1/2" | Concealed single lever mixer 1/2"

	109.20.125 1-Hand Wannenfüll- und Brausebatterie 1/2" für UP-Montage, Fertigmontageset	Concealed single lever wall tub and shower mixer 1/2", assembly set	A	B	C	D	E
	<ul style="list-style-type: none"> manuelle, keramische Umstellung für druckunabhängige Funktion mit Sicherheitseinrichtung Durchflussrate 21 l/min bei 3 bar 	<ul style="list-style-type: none"> manual, ceramic diverter tub/shower for pressure-independent function with safety device flow rate 21 l/min at 3 bar 	946,-	1.170,-	1.284,-	1.324,-	1.722,-
	<ul style="list-style-type: none"> manuelle, keramische Umstellung für druckunabhängige Funktion mit Sicherheitseinrichtung Durchflussrate 21 l/min bei 3 bar 	<ul style="list-style-type: none"> manual, ceramic diverter tub/shower for pressure-independent function with safety device flow rate 21 l/min at 3 bar 	F	G	H	I	L

Griffvariante | Handle alternative

	109.20.128 Brausebatterie 1/2" für Aufputzmontage	Exposed shower mixer 1/2"
<ul style="list-style-type: none"> mit Porzellangriff und Krakeleé 	<ul style="list-style-type: none"> with porcelain handle and crackleé 	

Griffvariante | Handle alternative

	109.20.124 Brausebatterie 1/2" für Aufputzmontage	Exposed shower mixer 1/2"
<ul style="list-style-type: none"> mit Hebelgriff, Metall 	<ul style="list-style-type: none"> with lever handle, metal 	

Benötigt | Required

	649.40.360 Unterputz-Einbaubox 1/2"	Concealed wall box 1/2"	A				
	<ul style="list-style-type: none"> zu Fertigmontageset 109.20.125, 109.20.126 und 109.20.124 für Nass- und Trockenbau geeignet 	<ul style="list-style-type: none"> for assembly set 109.20.125, 109.20.126 and 109.20.124 for wetwall and drywall construction 	168,-				

	109.20.235 1-Hand Brausebatterie 1/2" für UP-Montage, Fertigmontageset	Concealed single lever shower mixer 1/2", assembly set	A	B	C	D	E
	<ul style="list-style-type: none"> ohne Umstellung Funktionseinheit mit ker. Scheiben Durchflussrate 20,4 l/min bei 3 bar 	<ul style="list-style-type: none"> without diverter functional unit with ceramic discs flow rate 20,4 l/min at 3 bar 	689,-	833,-	1.033,-	1.088,-	1.359,-
	<ul style="list-style-type: none"> ohne Umstellung Funktionseinheit mit ker. Scheiben Durchflussrate 20,4 l/min bei 3 bar 	<ul style="list-style-type: none"> without diverter functional unit with ceramic discs flow rate 20,4 l/min at 3 bar 	F	G	H	I	L

Griffvariante | Handle alternative

	109.20.238 Brausebatterie 1/2" für Aufputzmontage	Exposed shower mixer 1/2"
<ul style="list-style-type: none"> mit Porzellangriff und Krakeleé 	<ul style="list-style-type: none"> with porcelain handle and crackleé 	

Griffvariante | Handle alternative

	109.20.234 Brausebatterie 1/2" für Aufputzmontage	Exposed shower mixer 1/2"
<ul style="list-style-type: none"> mit Hebelgriff, Metall 	<ul style="list-style-type: none"> with lever handle, metal 	

Benötigt | Required

	649.40.360 Unterputz-Einbaubox 1/2"	Concealed wall box 1/2"	A				
	<ul style="list-style-type: none"> zu Fertigmontageset 109.20.235, 109.20.236 und 109.20.234 für Nass- und Trockenbau geeignet 	<ul style="list-style-type: none"> for assembly set 109.20.235, 109.20.236 and 109.20.234 for wetwall and drywall construction 	168,-				

Unterputz-Thermostate 1/2" | Wall thermostats, concealed 1/2"

	109.40.380 Unterputz-Thermostat 1/2" mit Mengenregulierung, Fertigmontageset	Concealed wall thermostat 1/2" with flow control, assembly set	A	B	C	D	E
	<ul style="list-style-type: none"> manuelle, keramische Umstellung Wanne/Brause, druckunabhängig mit Sicherheitseinrichtung Durchflussrate 20,4 l/min bei 3 bar 	<ul style="list-style-type: none"> manual, ceramic diverter tub/shower for pressure-independent function with safety device flow rate 20,4 l/min at 3 bar 	1.092,-	1.294,-	1.476,-	1.522,-	1.805,-
	<ul style="list-style-type: none"> manuelle, keramische Umstellung Wanne/Brause, druckunabhängig mit Sicherheitseinrichtung Durchflussrate 20,4 l/min bei 3 bar 	<ul style="list-style-type: none"> manual, ceramic diverter tub/shower for pressure-independent function with safety device flow rate 20,4 l/min at 3 bar 	F	G	H	I	L

Benötigt | Required

	649.40.360 Unterputz-Einbaubox 1/2"	Concealed wall box 1/2"	A				
	<ul style="list-style-type: none"> zu Fertigmontageset 109.40.380 für Nass- und Trockenbau geeignet 	<ul style="list-style-type: none"> for assembly set 109.40.380 for wetwall and drywall construction 	168,-				

A chrom chrome	[.000]	E platin matt platinum matt	[.066]
B silbernickel polished nickel	[.035]	F nerz matt milk matt	[.096]
C nerz milk	[.095]	G schwarz-matt black matt	[.092]
C nickel matt satin nickel	[.036]	G weiß-matt white matt	[.052]
D edelmessing sunshine	[.040]	H bronze bronze	[.011]
D platin platinum	[.065]	I gold gold	[.020]
E edelmess.matt sunshine matt	[.041]	L roségold rosegold	[.022]
E gold matt gold matt	[.021]	L roségold matt rosegold matt	[.023]



109.40.360 Unterputz-Thermostat 1/2" mit Mengenregulierung, Fertigmontageset

- ohne Umstellung
- mit integrierter keramischer Mengenregulierung
- Durchflussrate 20,4 l/min bei 3 bar

Concealed wall thermostat 1/2" with flow control, assembly set

- without diverter
- with integrated ceramic cartridge for volume control
- flow rate 20,4 l/min at 3 bar

A	B	C	D	E
1.082,-	1.284,-	1.441,-	1.487,-	1.771,-
F	G	H	I	L
1.688,-	1.441,-	1.708,-	1.968,-	2.458,-

Variante | Alternative



109.40.460 Unterputz-Thermostat 1/2" ohne Mengenregulierung, Fertigmontageset

- Funktionseinheit ohne Umstellung und ohne Absperrung
- Durchflussrate 25,8 l/min bei 3 bar

Concealed wall thermostat 1/2" without flow control, assembly set

- Functional unit without diverter and without shut-off
- flow rate 25,8 l/min at 3 bar

A	B	C	D	E
874,-	1.018,-	1.214,-	1.334,-	1.664,-
F	G	H	I	L
1.509,-	1.212,-	1.455,-	1.834,-	2.118,-

Benötigt | Required



649.40.360 Unterputz-Einbaubox 1/2"

- zu Fertigmontageset 109.40.360 und 109.40.460
- für Nass- und Trockenbau geeignet

Concealed wall box 1/2"

- for assembly set 109.40.360 and 109.40.460
- for wetwall and drywall construction

A	B	C	D	E
168,-				

Unterputz-Thermostat 3/4" mit hohem Durchfluß | Wall thermostat, concealed 3/4" with high flow



109.40.560 Unterputz-Thermostat 3/4" ohne Mengenregulierung, Fertigmontageset

- serienbezogener Temperiergriff
- Sicherheitssperre bei 38° C

Concealed wall thermostat 3/4" without flow control, assembly set

- design handle for temp. control
- locking device at 38°C

A	B	C	D	E
536,-	872,-	996,-	1.041,-	1.349,-
F	G	H	I	L
1.218,-	972,-	1.294,-	1.509,-	1.929,-

Benötigt | Required



649.40.555 Unterputz-Einbaukörper 3/4"

- zu Fertigmontageset 109.40.560
- Kartusche mit Schmutzfangsieben
- für Nass- und Trockenbau geeignet
- Durchflussrate 64,2 l/min bei 3 bar
- ohne Absperrung

Concealed thermostat body 3/4"

- for assembly set 109.40.560
- cartridge with filter screens
- for wetwall and drywall construction
- flow rate 64,2 l/min at 3 bar
- without shut-off

A	B	C	D	E
1.636,-				

Unterputz-Thermostat 3/4" | Wall thermostat, concealed 3/4"



109.40.520 Unterputz-Thermostat 3/4" ohne Mengenregulierung, Fertigmontageset

- serienbezogener Temperiergriff
- Sicherheitssperre bei 38° C

Concealed wall thermostat 3/4" without flow control, assembly set

- design handle for temp. control
- locking device at 38°C

A	B	C	D	E
536,-	872,-	996,-	1.041,-	1.349,-
F	G	H	I	L
1.218,-	972,-	1.294,-	1.509,-	1.929,-

Benötigt | Required



649.40.520 Unterputz-Einbaukörper 3/4"

- zu Fertigmontageset 109.40.520
- Kartusche mit Schmutzfangsieben
- für Nass- und Trockenbau geeignet
- Durchflussrate 41 l/min bei 3 bar
- ohne Absperrung

Concealed thermostat body 3/4"

- for assembly set 109.40.520
- cartridge with filter screens
- for wetwall and drywall construction
- flow rate 41 l/min at 3 bar
- without shut-off

A	B	C	D	E
498,-				

Maßzeichnungen unter www.joerger.de - Menü SERVICE.
 Technical specifications under www.joerger.de - menu SERVICE.

A chrom chrome	[.000]	E platin matt platinum matt	[.066]
B silbernickel polished nickel	[.035]	F nerz matt mink matt	[.096]
C nerz mink	[.095]	G schwarz-matt black matt	[.092]
C nickel matt satin nickel	[.036]	G weiß-matt white matt	[.052]
D edelmessing sunshine	[.040]	H bronze bronze	[.011]
D platin platinum	[.065]	I gold gold	[.020]
E edelmess.matt sunshine matt	[.041]	L roségold rosegold	[.022]
E gold matt gold matt	[.021]	L roségold matt rosegold matt	[.023]

Unterputz-Thermostat/Ventil-Modul | Concealed thermostatic/wall-valve modul

			A	B	C	D	E
	109.60.432 Unterputz-Ventil-Modul Fertigmontageset <ul style="list-style-type: none"> mit Kreuzgriff Rosette 	Concealed wall-valve-modul assembly set <ul style="list-style-type: none"> with cross handle escutcheon 	198,-	224,-	277,-	316,-	380,-
Griffvariante Handle alternative							
	109.60.435 Unterputz-Ventil-Modul Fertigmontageset <ul style="list-style-type: none"> mit Hebelgriff, weiß 	Concealed wall-valve-modul assembly set <ul style="list-style-type: none"> with lever handle, white 		316,-	407,-	449,-	607,-
Griffvariante Handle alternative							
	109.60.438 Unterputz-Ventil-Modul Fertigmontageset <ul style="list-style-type: none"> mit Porzellangriff und Krakeleé 	Concealed wall-valve-modul assembly set <ul style="list-style-type: none"> with porcelain handle and crackleé 					
Griffvariante Handle alternative							
	109.60.434 Unterputz-Ventil-Modul Fertigmontageset <ul style="list-style-type: none"> mit Hebelgriff, Metall 	Concealed wall-valve-modul assembly set <ul style="list-style-type: none"> with lever handle, metal 					
Benötigt Required							
	649.20.610 Unterputz-Ventil-Modul, 1-fach <ul style="list-style-type: none"> 1x Spindelventil 3/4", rechtsschließend mit keram. Scheiben 2 Abgänge 1/2", je 1x rechts/links möglich, gleichzeitig benutzbar 	Concealed wall-valve-modul, single <ul style="list-style-type: none"> 1x spindle valve 3/4", clockwise closure with ceramic discs 2 outlets 1/2", each 1x right/left possible, simultaneously usable 	A 229,-				
	649.20.620 Unterputz-Ventil-Modul, 2-fach <ul style="list-style-type: none"> 2x Spindelventil 3/4", rechtsschließend mit keram. Scheiben 4 Abgänge 1/2", je 2x rechts/links möglich, gleichzeitig benutzbar im Verbund maßgenaue Montage erweiterbar mit 649.20.610 	Concealed wall-valve-modul, double <ul style="list-style-type: none"> 2x spindle valve 3/4", clockwise closure with ceramic discs 4 outlets 1/2", each 2x right/left possible, simultaneously usable precise assembly due to composite expandable with 649.20.610 	A 458,-				
	649.20.630 Unterputz-Ventil-Modul, 3-fach <ul style="list-style-type: none"> 3x Spindelventil 3/4", rechtsschließend mit keram. Scheiben 6 Abgänge 1/2", je 3x rechts/links möglich, gleichzeitig benutzbar im Verbund maßgenauen Montage erweiterbar mit 649.20.610 	Concealed wall-valve-modul, triple <ul style="list-style-type: none"> 3x spindle valve 3/4", clockwise closure with ceramic discs 6 outlets 1/2", each 3x right/left possible, simultaneously usable precise assembly due to composite expandable with 649.20.610 	A 686,-				
	109.40.460 Unterputz-Thermostat 1/2" <u>ohne</u> Mengenregulierung, Fertigmontageset <ul style="list-style-type: none"> Funktionseinheit <u>ohne</u> Umstellung und <u>ohne</u> Abspernung Durchflußrate 25,8 l/min bei 3 bar 	Concealed wall thermostat 1/2" <u>without</u> flow control, assembly set <ul style="list-style-type: none"> Functional unit <u>without</u> diverter and <u>without</u> shut-off flow rate 25,8 l/min at 3 bar 	A 874,-	B 1.018,-	C 1.214,-	D 1.334,-	E 1.664,-
Benötigt Required							
	649.20.612 Anschlußadapter 1/2" <ul style="list-style-type: none"> Anschlußadapter, Abschlußstopfen passend zu Einbaubox 649.40.360 	Connection adapter 1/2" <ul style="list-style-type: none"> connection adapter, end plug matching to wall box 649.40.360 	A 122,-				
	649.40.360 Unterputz-Einbaubox 1/2" <ul style="list-style-type: none"> zu Fertigmontageset 109.40.460 für Nass- und Trockenbau geeignet 	Concealed wall box 1/2" <ul style="list-style-type: none"> for assembly set 109.40.460 for wetwall and drywall construction 	A 168,-				

A chrom chrome	[.000]	E platin matt platinum matt	[.066]
B silbernickel polished nickel	[.035]	F nerz matt milk matt	[.096]
C nerz milk	[.095]	G schwarz-matt black matt	[.092]
C nickel matt satin nickel	[.036]	G weiß-matt white matt	[.052]
D edelmessing sunshine	[.040]	H bronze bronze	[.011]
D platin platinum	[.065]	I gold gold	[.020]
E edelmess.matt sunshine matt	[.041]	L roségold rosegold	[.022]
E gold matt gold matt	[.021]	L roségold matt rosegold matt	[.023]

	109.40.560 Unterputz-Thermostat ¾" ohne Mengenregulierung, Fertigmontageset <ul style="list-style-type: none"> ■ serienbezogener Temperiergriff ■ Sicherheitssperre bei 38° C 	Concealed wall thermostat ¾" without flow control, assembly set <ul style="list-style-type: none"> ■ design handle for temp. control ■ locking device at 38° C 	A	B	C	D	E
			536,-	872,-	996,-	1.041,-	1.349,-
			F	G	H	I	L
			1.218,-	972,-	1.294,-	1.509,-	1.929,-

Benötigt | Required

	649.20.634 Anschlußadapter ¾" <ul style="list-style-type: none"> ■ Anschlußadapter, Abschlußstopfen ■ passend zu Einbaukörper 649.40.555 	Connection adapter ¾" <ul style="list-style-type: none"> ■ connection adapter, end plug ■ matching to wall body 649.40.555 	A				
			146,-				

	649.40.555 Unterputz-Einbaukörper ¾" <ul style="list-style-type: none"> ■ zu Fertigmontageset 109.40.560 ■ Kartusche mit Schmutzfangsieben ■ für Nass- und Trockenbau geeignet ■ Durchflußrate 64,2 l/min bei 3 bar ■ ohne Absperrung 	Concealed thermostat body ¾" <ul style="list-style-type: none"> ■ for assembly set 109.40.560 ■ cartridge with filter screens ■ for wetwall and drywall construction ■ flow rate 64,2 l/min at 3 bar ■ without shut-off 	A				
			1.636,-				

Unterputz-Ventile | Valves, concealed

	109.50.234 Unterputz-Ventil Fertigmontageset <ul style="list-style-type: none"> ■ mit Kreuzgriff ■ Griff ■ Schubrosette, Hülse 	Concealed wall valve assembly set <ul style="list-style-type: none"> ■ with cross handle ■ design handle ■ socket with adjustable escutcheon 	A	B	C	D	E
			168,-	242,-	295,-	334,-	398,-
			F	G	H	I	L
			375,-	334,-	425,-	467,-	625,-

Variante | Alternative

	109.50.235 Unterputz-Ventil Fertigmontageset <ul style="list-style-type: none"> ■ mit Hebelgriff, weiß 	Concealed wall valve assembly set <ul style="list-style-type: none"> ■ with lever handle, white
---	--	---

Variante | Alternative

	109.50.238 Unterputz-Ventil Fertigmontageset <ul style="list-style-type: none"> ■ mit Porzellangriff und Krakeleé 	Concealed wall valve assembly set <ul style="list-style-type: none"> ■ with porcelain handle and crackleé
---	---	---

Variante | Alternative

	109.50.237 Unterputz-Ventil Fertigmontageset <ul style="list-style-type: none"> ■ mit Hebelgriff, Metall 	Concealed wall valve assembly set <ul style="list-style-type: none"> ■ with lever handle, metal
---	--	---

Benötigt | Required

	649.20.350 Unterputz-Ventil ½", Einbaukörper <ul style="list-style-type: none"> ■ rechtsschließend, ker. Scheiben 	Concealed wall valve ½", body <ul style="list-style-type: none"> ■ clockwise closure, ceramic discs 	A				
			66,-				

	649.20.355 Unterputz-Ventil ½", Einbaukörper <ul style="list-style-type: none"> ■ linksschließend, ker. Scheiben 	Concealed wall valve ½", body <ul style="list-style-type: none"> ■ counter-clockwise closure, cer. discs 	A				
			99,-				





	649.20.450 Unterputz-Ventil ¾", Einbaukörper <ul style="list-style-type: none"> ■ rechtsschließend, ker. Scheiben 	Concealed wall valve ¾", body <ul style="list-style-type: none"> ■ clockwise closure, ceramic discs 	A				
			99,-				

	649.20.455 Unterputz-Ventil ¾", Einbaukörper <ul style="list-style-type: none"> ■ linksschließend, ker. Scheiben 	Concealed wall valve ¾", body <ul style="list-style-type: none"> ■ counter-clockwise closure, cer. discs 	A				
			99,-				



Maßzeichnungen unter www.joerger.de - Menü SERVICE.
 Technical specifications under www.joerger.de - menu SERVICE.

A chrom chrome	[.000]	E platin matt platinum matt	[.066]
B silbernickel polished nickel	[.035]	F nerz matt mink matt	[.096]
C nerz mink	[.095]	G schwarz-matt black matt	[.092]
C nickel matt satin nickel	[.036]	G weiß-matt white matt	[.052]
D edelmessing sunshine	[.040]	H bronze bronze	[.011]
D platin platinum	[.065]	I gold gold	[.020]
E edelmess.matt sunshine matt	[.041]	L roségold rosegold	[.022]
E gold matt gold matt	[.021]	L roségold matt rosegold matt	[.023]

Unterputz-Umstellung | Diverter, concealed

	109.40.650 Unterputz 3-Wege Umstellung Fertigmontageset <ul style="list-style-type: none"> mit Kreuzgriff Griff Schubrosette, Hülse 	Concealed 3-position diverter assembly set <ul style="list-style-type: none"> with cross handle design handle socket with adjustable escutcheon 	A	B	C	D	E
			236,-	262,-	315,-	354,-	418,-
	Griffvariante Handle alternative		F	G	H	I	L
	109.40.655 Unterputz 3-Wege Umstellung Fertigmontageset <ul style="list-style-type: none"> mit Hebelgriff, weiß 	Concealed 3-position diverter assembly set <ul style="list-style-type: none"> with lever handle, white 					
	Griffvariante Handle alternative						
	109.40.658 Unterputz 3-Wege Umstellung Fertigmontageset <ul style="list-style-type: none"> mit Porzellangriff und Krakeleé 	Concealed 3-position diverter assembly set <ul style="list-style-type: none"> with porcelain handle and crackleé 					
	Griffvariante Handle alternative						
	109.40.654 Unterputz 3-Wege Umstellung Fertigmontageset <ul style="list-style-type: none"> mit Hebelgriff, Metall 	Concealed 3-position diverter assembly set <ul style="list-style-type: none"> with lever handle, metal 					
	Benötigt Required		A				
	649.40.600 Unterputz 3-Wege Umstellung Einbaukörper 1/2" <ul style="list-style-type: none"> zu Fertigmontageset 109.40.650, 109.40.655, 109.40.656 und 109.40.654 	Concealed 3-position diverter diverter body 1/2" <ul style="list-style-type: none"> for assembly set 109.40.650, 109.40.655, 109.40.656 and 109.40.654 	236,-				

Brausen | Showers

	109.13.300 Duschgarnitur, komplett <ul style="list-style-type: none"> Wandrohr 900 mm, mit Schieber Metall-Handbrause mit Anti-Kalk-System und Rückflussverhinderer Metall-Brauseschlauch 1750 mm, beidseitig mit drehbarem Konus 	Shower bar set, complete <ul style="list-style-type: none"> wall bar 900 mm, with slider metal hand shower with anticalc. system and backflow preventer metal shower hose 1750 mm, both sides with turning cone 	A	B	C	D	E
			498,-	884,-	1.098,-	1.179,-	1.598,-
			F	G	H	I	L
			1.484,-	1.179,-	1.734,-	1.916,-	2.926,-
	109.13.350 Duschstange, lose <ul style="list-style-type: none"> Wandrohr 900 mm, mit Schieber 	Shower bar, separate <ul style="list-style-type: none"> wall bar 900 mm, with slider 	A	B	C	D	E
			314,-	546,-	670,-	714,-	925,-
			F	G	H	I	L
			848,-	670,-	1.108,-	1.242,-	1.719,-
	109.13.200 Schlauchbrausegarnitur <ul style="list-style-type: none"> Wandanschlußbogen 1/2", Schubrosette, Wand-Brausehalter Metall-Handbrause mit Anti-Kalk-System und Rückflussverhinderer Metall-Brauseschlauch 1500 mm 	Shower combination <ul style="list-style-type: none"> wall elbow connection 1/2" wall fitting for hand shower metal hand shower with anticalc. system and backflow preventer flexible metal shower hose 1500 mm 	A	B	C	D	E
			364,-	486,-	596,-	672,-	862,-
			F	G	H	I	L
			772,-	755,-	1.075,-	1.069,-	1.610,-
	109.13.237 Hygienebrausegarnitur <ul style="list-style-type: none"> Wandbrausehalter und -anschlußbogen 1/2", Schubrosette Hygienebrause, klassisch (649.13.338), komplett aus Metall einstrahlig, Bedienung über Druckhebel Metall-Brauseschlauch 1250 mm 	Ablution spray combination <ul style="list-style-type: none"> wall fitting and elbow connection 1/2" spray handshower, classical (649.13.338), completely metal one jet, push-lever operation flexible metal shower hose 1250 mm 	A	B	C	D	E
			309,-	473,-	598,-	629,-	859,-
			F	G	H	I	L
			739,-	659,-	996,-	1.049,-	1.529,-

A chrom chrome	[.000]	E platin matt platinum matt	[.066]
B silbernickel polished nickel	[.035]	F nerz matt milk matt	[.096]
C nerz milk	[.095]	G schwarz-matt black matt	[.092]
C nickel matt satin nickel	[.036]	G weiß-matt white matt	[.052]
D edelmessing sunshine	[.040]	H bronze bronze	[.011]
D platin platinum	[.065]	I gold gold	[.020]
E edelmess.matt sunshine matt	[.041]	L roségold rosegold	[.022]
E gold matt gold matt	[.021]	L roségold matt rosegold matt	[.023]



109.20.237 1-Hand Batterie 1/2" für Hygiene-Brause, Fertigmontageset
 ■ Rosette, Griff
 ■ mit Hebelgriff, weiß

Concealed single lever 1/2" for abluion spray, assembly set
 ■ escutcheon, handle
 ■ with lever handle, white

A	B	C	D	E
249,-	309,-	397,-	446,-	525,-
F	G	H	I	L
494,-	446,-	532,-	586,-	872,-

Griffvariante | Handle alternative



109.20.287 1-Hand Batterie 1/2" für Hygiene-Brause, Fertigmontageset
 ■ mit Porzellanriff und Krakeelé

Concealed single lever 1/2" for abluion spray, assembly set
 ■ with porcelain handle and crackleé

Griffvariante | Handle alternative



109.20.247 1-Hand Batterie 1/2" für Hygiene-Brause, Fertigmontageset
 ■ mit Hebelgriff, Metall

Concealed single lever 1/2" for abluion spray, assembly set
 ■ with lever handle, metal

Benötigt | Required



649.20.237 Unterputz 1-Hand Batterie 1/2", Einbaukörper
 ■ Kartusche mit keramischen Scheiben
 ■ zu Fertigmontageset 109.20.237, 109.20.267 und 109.20.247

Single lever mixer 1/2", concealed body
 ■ cartridge with ceramic discs
 ■ for assembly set 109.20.237, 109.20.267 and 109.20.247

A	B	C	D	E
125,-	169,-	208,-	229,-	268,-
F	G	H	I	L
249,-	224,-	258,-	329,-	396,-



109.13.150 Wandanschlußbogen 1/2", ohne Haken
 ■ Brauseabgang 1/2"
 ■ mit Rückflussverhinderer, Rosette

Wall elbow connection 1/2", without cradle
 ■ discharge 1/2"
 ■ with backflow preventer, escutcheon

A	B	C	D	E
118,-	146,-	170,-	190,-	234,-
F	G	H	I	L
212,-	166,-	196,-	246,-	309,-



649.13.210 Wand-Brausehalter

Wall fitting for hand shower

A	B	C	D	E
178,-	214,-	266,-	287,-	337,-
F	G	H	I	L
299,-	256,-	325,-	374,-	459,-



649.13.615 Stachelkopfbrause 1/2"
 ■ ø 230 mm, 75 Düsen
 ■ Metall, Anti-Kalk-System
 ■ Brausekopf schwenkbar
 ■ ohne Wandarm
 ■ weitere, zur Serie passende Kopfbrausen siehe Kapitel "Brausen"

Body spray shower head 1/2"
 ■ ø 230 mm, 75 jets
 ■ full metal, anticalcareous system
 ■ swivel shower head
 ■ without wall bracket
 ■ for further shower heads matching this collection see chapter "showers"

A	B	C	D	E
969,-	1.232,-	1.359,-	1.416,-	1.659,-
F	G	H	I	L
1.496,-	1.399,-	1.718,-	2.262,-	2.739,-

Empfohlen | Recommended



649.13.625 Wandarm 1/2"
 ■ Ausladung 162 mm
 ■ weitere, zur Serie passende Wandarme siehe Kapitel "Brausen"

Wall bracket 1/2"
 ■ projection 162 mm
 ■ for further wall brackets matching this collection see chapter "showers"

A	B	C	D	E
126,-	145,-	171,-	189,-	250,-
F	G	H	I	L
229,-	192,-	296,-	286,-	499,-

DELPHI

Maßzeichnungen unter www.joerger.de - Menü SERVICE.
 Technical specifications under www.joerger.de - menu SERVICE.

A chrom chrome	[.000]	E platin matt platinum matt	[.066]
B silbernickel polished nickel	[.035]	F nerz matt mink matt	[.096]
C nerz mink	[.095]	G schwarz-matt black matt	[.092]
C nickel matt satin nickel	[.036]	G weiß-matt white matt	[.052]
D edelmessing sunshine	[.040]	H bronze bronze	[.011]
D platin platinum	[.065]	I gold gold	[.020]
E edelmess.matt sunshine matt	[.041]	L roségold rosegold	[.022]
E gold matt gold matt	[.021]	L roségold matt rosegold matt	[.023]



- 649.13.519 Seitenbrause 1/2"**
- Rosette ø 130 mm, Wandmontage
 - Brausekopf schwenkbar, 20°
 - Anti-Kalk-System
 - Material: Kunststoff
- weitere, zur Serie passende Seitenbrausen siehe Kapitel "Brausen"

- Body spray side shower 1/2"**
- escutcheon ø 130 mm, wall assembly
 - swivel shower head, 20°
 - anticalcareous system
 - material: plastic
- for further side showers matching this collection see chapter "showers"

A	B	C	D	E
167,-	326,-	385,-	399,-	542,-
F	G	H	I	L
496,-	376,-	472,-	634,-	949,-











- 649.13.335 Handbrause**
- Anti-Kalk-System
 - Ausführung Metall
 - Anschluss 1/2"
- weitere, zur Serie passende Handbrausen siehe Kapitel "Brausen"

- Hand shower**
- anticalcareous system
 - brass
 - connection 1/2"
- for further hand showers matching this collection see chapter "showers"

A	B	C	D	E
216,-	269,-	316,-	327,-	402,-
F	G	H	I	L
363,-	336,-	538,-	628,-	919,-

A chrom chrome	[.000]	E platin matt platinum matt	[.066]
B silbernickel polished nickel	[.035]	F nerz matt milk matt	[.096]
C nerz milk	[.095]	G schwarz-matt black matt	[.092]
C nickel matt satin nickel	[.036]	G weiß-matt white matt	[.052]
D edelmessing sunshine	[.040]	H bronze bronze	[.011]
D platin platinum	[.065]	I gold gold	[.020]
E edelmess.matt sunshine matt	[.041]	L roségold rosegold	[.022]
E gold matt gold matt	[.021]	L roségold matt rosegold matt	[.023]

Accessoires für Handtücher | Accessories for towels

		A	B	C	D	E
	109.00.002 Handtuchhalter, doppelt	Double towel bar				
	<ul style="list-style-type: none"> ■ Rohre schwenkbar ■ ca. 450 mm 	<ul style="list-style-type: none"> ■ swivelling bars ■ approx. 450 mm 				
		196,-	258,-	318,-	342,-	426,-
		F	G	H	I	L
		384,-	379,-	468,-	679,-	1.038,-
	109.00.047 Handtuchring	Towel ring				
	<ul style="list-style-type: none"> ■ ø ca. 205 mm ■ geschlossene Ausführung 	<ul style="list-style-type: none"> ■ ø approx. 205 mm ■ closed version 				
		134,-	157,-	189,-	208,-	258,-
		F	G	H	I	L
		229,-	246,-	268,-	292,-	728,-
	109.00.022 Handtuchhaken, doppelt	Double robe hanger				
		99,-	127,-	158,-	186,-	236,-
		F	G	H	I	L
		205,-	218,-	246,-	279,-	398,-
	109.00.040 Badetuchhalter	Bath towel bar				
	<ul style="list-style-type: none"> ■ ca. 710 mm 	<ul style="list-style-type: none"> ■ approx. 710 mm 				
		208,-	286,-	358,-	397,-	544,-
		F	G	H	I	L
		466,-	399,-	658,-	684,-	1.474,-
	109.00.030 Duschtürgriff	Shower door handle				
	<ul style="list-style-type: none"> ■ ca. 610 mm 	<ul style="list-style-type: none"> ■ approx. 610 mm 				
		466,-	584,-	709,-	789,-	1.016,-
		F	G	H	I	L
		884,-	856,-	1.118,-	1.208,-	2.075,-
	109.00.031 Wannengriff	Tub handle				
	<ul style="list-style-type: none"> ■ ca. 510 mm 	<ul style="list-style-type: none"> ■ approx. 510 mm 				
		184,-	229,-	289,-	326,-	410,-
		F	G	H	I	L
		372,-	352,-	528,-	516,-	926,-
	109.00.041 Badetuchhalter, doppelt	Bath towel bar, double				
	<ul style="list-style-type: none"> ■ ca. 710 mm 	<ul style="list-style-type: none"> ■ approx. 710 mm 				
		316,-	480,-	556,-	634,-	979,-
		F	G	H	I	L
		818,-	626,-	869,-	1.072,-	2.118,-
	109.00.104 Gästehandtuchkorb, eckig	Guest towel basket, angular				
	<ul style="list-style-type: none"> ■ mit Ablage ■ Korbgröße 260 x 150 x 190 mm 	<ul style="list-style-type: none"> ■ with shelf ■ basket size 260 x 150 x 190 mm 				
		359,-	456,-	606,-	672,-	792,-
		F	G	H	I	L
		724,-	592,-	972,-	1.049,-	1.879,-

Maßzeichnungen unter www.joerger.de - Menü SERVICE.
 Technical specifications under www.joerger.de - menu SERVICE.

A chrom chrome	[.000]	E platin matt platinum matt	[.066]
B silbernickel polished nickel	[.035]	F nerz matt mink matt	[.096]
C nerz mink	[.095]	G schwarz-matt black matt	[.092]
C nickel matt satin nickel	[.036]	G weiß-matt white matt	[.052]
D edelmessing sunshine	[.040]	H bronze bronze	[.011]
D platin platinum	[.065]	I gold gold	[.020]
E edelmess.matt sunshine matt	[.041]	L roségold rosegold	[.022]
E gold matt gold matt	[.021]	L roségold matt rosegold matt	[.023]

Accessoires für Waschplatz | Accessories for washstands

		A	B	C	D	E
	109.00.007 Seifenhalter, komplett ■ Kristallglas	Soap dish holder, complete ■ crystal glass dish		216,-	264,-	318,-
		338,-	394,-			
		F	G	H	I	L
		368,-	319,-	338,-	469,-	679,-
	109.00.307 Seifenschale, lose	Glass dish, separate		A		
		98,-				
	109.00.017 Seifenhalter, komplett ■ Standmodell ■ Seifenschale aus Kristallglas	Soap dish holder, complete ■ free standing version ■ crystal glass dish		189,-	232,-	278,-
		322,-	279,-	296,-	410,-	594,-
		F	G	H	I	L
		322,-	279,-	296,-	410,-	594,-
	109.00.006 Lotionspender, komplett	Soap dispenser, complete		309,-	336,-	376,-
		458,-	418,-	484,-	568,-	819,-
		F	G	H	I	L
		458,-	418,-	484,-	568,-	819,-
	713.00.306 Lotionspenderglas, lose ■ seidenmatt, ohne Pumpe	Soap dispenser glass, separate ■ frosted, without pump		A		
		78,-				
	109.00.016 Lotionspender, komplett ■ Standmodell ■ Glas aus Kristallglas, seidenmatt	Soap dispenser, complete ■ free standing version ■ crystal glass, frosted		246,-	294,-	329,-
		399,-	366,-	424,-	497,-	717,-
		F	G	H	I	L
		399,-	366,-	424,-	497,-	717,-
	109.00.105 Schwammkorb ■ rechteckig, 260 x 130 mm	Sponge basket ■ rectangular, 260 x 130 mm		344,-	440,-	509,-
		618,-	544,-	732,-	852,-	1.249,-
		F	G	H	I	L
		618,-	544,-	732,-	852,-	1.249,-
	109.00.106 Eckschwammkorb ■ 195 x 195 mm	Corner sponge basket ■ 195 x 195 mm		339,-	415,-	474,-
		589,-	539,-	689,-	793,-	1.149,-
		F	G	H	I	L
		589,-	539,-	689,-	793,-	1.149,-
	109.00.036 Glashalter, komplett ■ Glas aus Kristallglas	Tumbler holder, complete ■ crystal glass tumbler		259,-	306,-	359,-
		412,-	362,-	380,-	512,-	722,-
		F	G	H	I	L
		412,-	362,-	380,-	512,-	722,-
	713.00.336 Mundglas, lose	Glass tumbler, separate		A		
		78,-				

Maßzeichnungen unter www.joerger.de - Menü SERVICE.
 Technical specifications under www.joerger.de - menu SERVICE.

A chrom chrome	[.000]	E platin matt platinum matt	[.066]
B silbernickel polished nickel	[.035]	F nerz matt milk matt	[.096]
C nerz milk	[.095]	G schwarz-matt black matt	[.092]
C nickel matt satin nickel	[.036]	G weiß-matt white matt	[.052]
D edelmessing sunshine	[.040]	H bronze bronze	[.011]
D platin platinum	[.065]	I gold gold	[.020]
E edelmess.matt sunshine matt	[.041]	L roségold rosegold	[.022]
E gold matt gold matt	[.021]	L roségold matt rosegold matt	[.023]

	109.00.046 Glashalter, komplett ■ Standmodell ■ Glas aus Kristallglas, seidenmatt	Tumbler holder, complete ■ free standing version ■ crystal glass tumbler, frosted	A	B	C	D	E
			196,-	238,-	285,-	302,-	352,-
			F	G	H	I	L
			329,-	286,-	306,-	417,-	599,-

	109.00.009 Ablage, 600 mm ■ Glasplatte aus Kristallglas	Shelf holder with glass, 600 mm ■ crystal glass shelf	A	B	C	D	E
			412,-	490,-	569,-	642,-	757,-
			F	G	H	I	L
			698,-	495,-	684,-	849,-	1.059,-

Accessoires für WC-Bereich | Accessories for w.c. area

	109.00.014 Papierhalter ■ mit Deckel	Toilet paper roll holder ■ with lid	A	B	C	D	E
			159,-	229,-	261,-	292,-	384,-
			F	G	H	I	L
			346,-	299,-	485,-	489,-	974,-

	109.00.015 Reserve-Papierhalter	Spare toilet paper roll holder	A	B	C	D	E
			110,-	158,-	196,-	235,-	305,-
			F	G	H	I	L
			269,-	194,-	308,-	356,-	548,-

	109.00.001 Klosettbürstengarnitur, komplett ■ stehendes Modell	Toilet brush holder set, complete ■ floor standing model	A	B	C	D	E
			229,-	299,-	375,-	422,-	508,-
			F	G	H	I	L
			486,-	399,-	536,-	679,-	1.339,-

	109.00.000 Klosettbürstengarnitur, komplett ■ wandhängendes Modell	Toilet brush holder set, complete ■ suspended model	A	B	C	D	E
			289,-	374,-	448,-	496,-	589,-
			F	G	H	I	L
			529,-	454,-	585,-	778,-	1.398,-



	159.00.053 Bürstenstange komplett, lose	Brush rod with brush, separate	A	B	C	D	E
			136,-	138,-	222,-	248,-	294,-
			F	G	H	I	L
			284,-	178,-	224,-	342,-	379,-

799.00.236 Bürstenkopf, lose	Brush, separate	A				
		22,-				

Maßzeichnungen unter www.joerger.de - Menü SERVICE.
 Technical specifications under www.joerger.de - menu SERVICE.

A chrom chrome	[.000]	E platin matt platinum matt	[.066]
B silbernickel polished nickel	[.035]	F nerz matt mink matt	[.096]
C nerz mink	[.095]	G schwarz-matt black matt	[.092]
C nickel matt satin nickel	[.036]	G weiß-matt white matt	[.052]
D edelmessing sunshine	[.040]	H bronze bronze	[.011]
D platin platinum	[.065]	I gold gold	[.020]
E edelmess.matt sunshine matt	[.041]	L roségold rosegold	[.022]
E gold matt gold matt	[.021]	L roségold matt rosegold matt	[.023]

Spiegel und Leuchten | Mirrors and lamps

	109.00.061 Wandleuchte, komplett Leuchtenglas matt ■ mit Leuchtmittel, 40 W	Wall lamp, complete Glass frosted ■ light bulb included, 40 W	A	C	D	E	F
			459,-	549,-	711,-	799,-	942,-
			G	H	I	K	L
			859,-	709,-	926,-	1.096,-	1.634,-
			A				
	109.00.361 Leuchtenglas, lose ■ Leuchtenglas matt	Glass, separate ■ glass frosted	119,-				
	649.00.414 Kosmetikspiegel, beleuchtet ■ schwenk- und ausziehbar ■ 3-fache Vergrößerung ■ Direktanschluss ■ Spiegeldurchmesser 185 mm ■ Rahmendurchmesser 250 mm ■ Kalt-, Warm- und Taglicht durch Piezzo-Schalter umschaltbar	Cosmetic mirror, incl. lighting ■ swivelling and extendable ■ magnification 3:1 ■ direct connection ■ mirror diameter 185 mm ■ frame diameter 250 mm ■ cold, warm and day light switchable by Piezzo switch	A	B	C	D	E
			556,-	988,-	1.214,-	1.418,-	1.828,-
			F	G	H	I	L
			1.684,-	1.214,-	1.549,-	2.138,-	2.998,-



Oberflächen | colours

Folgende Oberflächen sind bei dieser Serie möglich |
The following colours are possible with this collection

chrom		chrome	[.000]	PG A
chrom/gold		chrome/gold	[.002]	PG B
silbernickel		polished nickel	[.035]	PG B
nerz		mink	[.095]	PG C
nickel matt		satin nickel	[.036]	PG C
edelmessing		sunshine	[.040]	PG D
platin		platinum	[.065]	PG D
edelmessing matt		sunshine matt	[.041]	PG E
gold matt		gold matt	[.021]	PG E
platin matt		platinum matt	[.066]	PG E
nerz matt		mink matt	[.096]	PG F
schwarz matt		black matt	[.092]	PG G
weiß matt		white matt	[.052]	PG G
bronze		bronze	[.011]	PG H
gold		gold	[.020]	PG I
roségold		rosegold	[.022]	PG L
roségold matt		rosegold matt	[.023]	PG L

Andere Oberflächen auf Anfrage |
Different colours on request

Auf Anfrage können wir Produkte von Drittanbietern auch gerne passend zu unseren Oberflächen veredeln (vorbehaltlich der Eignungsprüfung) | Third-party products may be plated matching to our colours on request (subject to valuation of suitability)

Waschtisch | Washbasin

ab Seite | from page 174

Bidet | Bidet

ab Seite | from page 174

Wanne | Bath tub

ab Seite | from page 175

Dusche | Shower

ab Seite | from page 177

Maßzeichnungen unter www.joerger.de - Menü SERVICE.
 Technical specifications under www.joerger.de - menu SERVICE.

A chrom chrome	[.000]	E platin matt platinum matt	[.066]
B silbernickel polished nickel	[.035]	F nerz matt mink matt	[.096]
C nerz mink	[.095]	G schwarz-matt black matt	[.092]
C nickel matt satin nickel	[.036]	G weiß-matt white matt	[.052]
D edelmessing sunshine	[.040]	H bronze bronze	[.011]
D platin platinum	[.065]	I gold gold	[.020]
E edelmess.matt sunshine matt	[.041]	L roségold rosegold	[.022]
E gold matt gold matt	[.021]	L roségold matt rosegold matt	[.023]

- 11 kristallklar | clear as crystal
- 12 schwarz | black

Die Artikelnummer wird um weitere 2 Ziffern erweitert. Beispiel:
 Waschtisch 3-Loch Batterie in chrom mit Hebelgriffen in kristallklar:

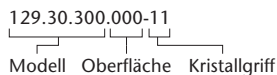

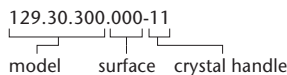

The article number needs to be added by 2 additional figures. For example:
 washbasin 3-hole mixer in chrome with lever handles in clear as crystal:



Waschtisch Batterien | Washbasin mixer

	129.30.300 Waschtisch 3-Loch Batterie ½" <ul style="list-style-type: none"> ■ Ausladung 150 mm; Höhe 125 mm ■ 2 Seitenrandventile mit keramischen Oberteilen ½" ■ Exzenter-Ablaufgarnitur 1 ¼" ■ empfohlen: 2x 649.15.530 - Kupferrohr 300 mm 	Washbasin 3-hole mixer ½" <ul style="list-style-type: none"> ■ spout projection 150 mm; height 125 mm ■ 2 side valves with ceramic internal upper parts ½", pop-up waste ■ recommended: 2x 649.15.530 - copper tube 300 mm 	A	B	C	D	E
			949,-	1.240,-	1.365,-	1.536,-	1.811,-
			F	G	H	I	L
			1.667,-	1.332,-	1.599,-	1.973,-	2.690,-

	129.10.333 Waschtisch 1-Hand Batterie <ul style="list-style-type: none"> ■ Ausladung 110 mm; Höhe 150 mm ■ Kartusche mit keramischen Scheiben ■ Exzenter-Ablaufgarnitur 1 ¼" ■ 2 Kupferrohre M10x1 x 400 mm 	Single lever washbasin mixer <ul style="list-style-type: none"> ■ spout projection 110 mm; height 150 mm ■ cartridge with ceramic discs ■ pop-up waste 1 ¼" ■ 2 copper tubes M10x1 x 400 mm 	A	B	C	D	E
			598,-	821,-	909,-	1.023,-	1.253,-
			F	G	H	I	L
			1.123,-	978,-	1.208,-	1.416,-	2.392,-

	129.30.360 Wand-Waschtisch 3-Loch Batterie ½", Fertigmontageset <ul style="list-style-type: none"> ■ Wand-Auslauf, Ausladung 200 - 212 mm ■ Griff, Hülse, Rosette ■ Oberteile ½", keramische Scheiben 	Wall washbasin 3-hole mixer ½" assembly set <ul style="list-style-type: none"> ■ wall spout, projection 200 - 212 mm ■ design handle, sleeve, escutcheon ■ cartridges ½", with ceramic discs 	A	B	C	D	E
			956,-	1.108,-	1.190,-	1.338,-	1.576,-
			F	G	H	I	L
			1.438,-	1.324,-	1.554,-	1.718,-	2.768,-

Benötigt | Required

	649.30.380 Wand-Waschtisch 3-Loch Batterie ½", Einbaukörper <ul style="list-style-type: none"> ■ 2 Anschlüsse, Stichmaß 204 mm ■ zu Fertigmontageset 129.30.360 	Wall washbasin 3-hole mixer ½" concealed body <ul style="list-style-type: none"> ■ 2 connections, center distance 204 mm ■ for assembly set 129.30.360 	A				
			296,-				

Bidet Batterien | Bidet mixer

	129.10.111 Bidet 1-Hand Batterie <ul style="list-style-type: none"> ■ Ausladung 125 mm; Höhe 150 mm ■ Kartusche mit keramischen Scheiben ■ Exzenter-Ablaufgarnitur 1 ¼" ■ 2 Kupferrohre M10x1 x 400 mm 	Single lever bidet mixer <ul style="list-style-type: none"> ■ spout projection 125 mm; height 150 mm ■ cartridge with ceramic discs ■ pop-up waste 1 ¼" ■ 2 copper tubes M10x1 x 400 mm 	A	B	C	D	E
			759,-	926,-	1.102,-	1.240,-	1.519,-
			F	G	H	I	L
			1.382,-	1.166,-	1.384,-	1.685,-	2.578,-

Zubehör für Waschtisch- und Bidet-Batterien | Supplies for washbasin and bidet mixer

	649.15.340 Waschtisch-Tassensiphon 1 ¼" <ul style="list-style-type: none"> ■ schwere Ausführung ■ Rosette ■ Abgangsrohr ø 32 mm ■ Tauchrohrlänge 165 mm 	Washbasin cupped siphon trap 1 ¼" <ul style="list-style-type: none"> ■ heavy brass ■ escutcheon ■ outlet tube ø 32 mm ■ dip pipe 165 mm 	A	B	C	D	E
			195,-	296,-	368,-	429,-	568,-
			F	G	H	I	L
			498,-	378,-	539,-	686,-	832,-

Maßzeichnungen unter www.joerger.de - Menü SERVICE.
 Technical specifications under www.joerger.de - menu SERVICE.

A chrom chrome	[.000]	E platin matt platinum matt	[.066]
B silbernickel polished nickel	[.035]	F nerz matt milk matt	[.096]
C nerz milk	[.095]	G schwarz-matt black matt	[.092]
C nickel matt satin nickel	[.036]	G weiß-matt white matt	[.052]
D edelmessing sunshine	[.040]	H bronze bronze	[.011]
D platin platinum	[.065]	I gold gold	[.020]
E edelmess.matt sunshine matt	[.041]	L roségold rosegold	[.022]
E gold matt gold matt	[.021]	L roségold matt rosegold matt	[.023]

- 11 kristallklar | clear as crystal
- 12 schwarz | black

Die Artikelnummer wird um weitere 2 Ziffern erweitert. Beispiel:
 Waschtisch 3-Loch Batterie in chrom mit Hebelgriffen in kristallklar:

129.30.300.000-11
 Modell Oberfläche Kristallgriff

The article number needs to be added by 2 additional figures. For example:
 washbasin 3-hole mixer in chrome with lever handles in clear as crystal:

129.30.300.000-11
 model surface crystal handle



- 649.15.330** Bidet-Tassensiphon 1 1/4"
 ■ Rosette
 ■ Abgangsrohr ø 32 mm

- Bidet cupped siphon trap 1 1/4"**
 ■ escutcheon
 ■ outlet tube ø 32 mm

A	B	C	D	E
98,-	166,-	276,-	332,-	472,-
F	G	H	I	L
399,-	364,-	508,-	648,-	796,-



- 129.12.100** Eckventil 1/2"
 ■ Ausladung 116 mm
 ■ Fettkammer-Innenoberteil 1/2"
 ■ Quetschverschraubung
 ■ Schubrossette

- Angle valve 1/2"**
 ■ projection 116 mm
 ■ cartridge 1/2"
 ■ compression joint
 ■ escutcheon

A	B	C	D	E
339,-	384,-	446,-	503,-	589,-
F	G	H	I	L
545,-	436,-	546,-	654,-	789,-



- 649.15.530** Kupferrohr, 300 mm
 ■ mit Bördel, für Quetschverschraubung

- Copper tube, 300 mm**
 ■ with flange, for compression joint

A	B	C	D	E
15,-	38,-	55,-	62,-	74,-
F	G	H	I	L
69,-	75,-	94,-	112,-	169,-

Variante | Alternative



- 649.15.550** Kupferrohr, 500 mm
 ■ mit Bördel, für Quetschverschraubung

- Copper tube, 500 mm**
 ■ with flange, for compression joint

A	B	C	D	E
20,-	58,-	77,-	87,-	102,-
F	G	H	I	L
97,-	77,-	96,-	134,-	219,-

Badewanne, Stand-Batterien | Bath tub mixer sets, deck mount



- 129.40.100** 4-Loch Wannenfüll- und Brausebatterie 1/2", für Standmontage
 ■ Ausladung 195 mm; Höhe 146 mm
 ■ 2 Seitenrandventile mit ker. Oberteilen 1/2"
 ■ Metall-Brauseschlauch 2000 mm
 ■ Metall-Handbrause mit Anti-Kalk-System und Rückflussverhinderer

- Tub/shower mixer set 1/2", deck mount**
 ■ spout projection 195 mm; height 146 mm
 ■ 2 side valves, cer. internal upper parts 1/2"
 ■ metal shower hose 2000 mm
 ■ metal hand shower with anticalc. system and backflow preventer

A	B	C	D	E
1.694,-	1.996,-	2.312,-	2.599,-	3.062,-
F	G	H	I	L
2.888,-	2.256,-	2.708,-	3.506,-	3.939,-

Empfohlen | Recommended



- 649.40.160** Montageplatte, komplett
 ■ für 4-Loch Armaturen
 ■ Druckschläuche 1/2" x 1/2" x 600 mm
 ■ empfohlen: Schlauchkastensystem siehe Kapitel "Serienübergreifendes"

- Assembly plate, complete**
 ■ for deck mounted tub/shower mixer
 ■ pressure hoses 1/2" x 1/2" x 600 mm
 ■ recommended: system with hose box see chapter "universal products"

A	B	C	D	E
308,-				

Maßzeichnungen unter www.joerger.de - Menü SERVICE.
 Technical specifications under www.joerger.de - menu SERVICE.

A chrom chrome	[.000]	E platin matt platinum matt	[.066]
B silbernickel polished nickel	[.035]	F nerz matt mink matt	[.096]
C nerz mink	[.095]	G schwarz-matt black matt	[.092]
C nickel matt satin nickel	[.036]	G weiß-matt white matt	[.052]
D edelmessing sunshine	[.040]	H bronze bronze	[.011]
D platin platinum	[.065]	I gold gold	[.020]
E edelmess.matt sunshine matt	[.041]	L roségold rosegold	[.022]
E gold matt gold matt	[.021]	L roségold matt rosegold matt	[.023]

- 11 kristallklar | clear as crystal
- 12 schwarz | black

Die Artikelnummer wird um weitere 2 Ziffern erweitert. Beispiel:
 Waschtisch 3-Loch Batterie in chrom mit Hebelgriffen in kristallklar:

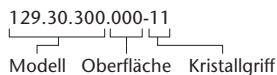

The article number needs to be added by 2 additional figures. For example:
 washbasin 3-hole mixer in chrome with lever handles in clear as crystal:

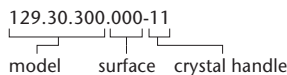

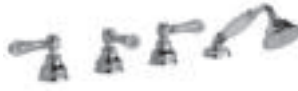

	129.40.150 4-Loch Wannenrandkombination 1/2" ■ für Ab- und Überlaufgarnitur mit Wanneneinlauf, ohne Rohrunterbrecher ■ Seitenrandventile, 2-Wege Umstellung ■ Metall-Brauseschlauch 2000 mm ■ Metall-Handbrause mit Anti-Kalk-System und Rückflussverhinderer	tub/shower combination 1/2" ■ for waste and overflow set with bath tub filler spout, without pipe interrupter ■ side valves, 2-position diverter ■ metal shower hose 2000 mm ■ metal hand shower with anticalc. system and backflow preventer	<table border="1" style="width: 100%; border-collapse: collapse;"> <tr> <th>A</th> <th>B</th> <th>C</th> <th>D</th> <th>E</th> </tr> <tr> <td style="text-align: center;">1.356,-</td> <td style="text-align: center;">1.632,-</td> <td style="text-align: center;">2.122,-</td> <td style="text-align: center;">2.389,-</td> <td style="text-align: center;">2.638,-</td> </tr> <tr> <th>F</th> <th>G</th> <th>H</th> <th>I</th> <th>L</th> </tr> <tr> <td style="text-align: center;">2.537,-</td> <td style="text-align: center;">2.069,-</td> <td style="text-align: center;">2.456,-</td> <td style="text-align: center;">2.729,-</td> <td style="text-align: center;">3.198,-</td> </tr> </table>	A	B	C	D	E	1.356,-	1.632,-	2.122,-	2.389,-	2.638,-	F	G	H	I	L	2.537,-	2.069,-	2.456,-	2.729,-	3.198,-
	A	B	C	D	E																		
1.356,-	1.632,-	2.122,-	2.389,-	2.638,-																			
F	G	H	I	L																			
2.537,-	2.069,-	2.456,-	2.729,-	3.198,-																			

Empfohlen | Recommended

	649.40.160 Montageplatte, komplett ■ für 4-Loch Armaturen ■ Druckschläuche 1/2" x 1/2" x 600 mm ■ empfohlen: Schlauchkastensystem siehe Kapitel "Serienübergreifendes"	Assembly plate, complete ■ for deck mounted tub/shower mixer ■ pressure hoses 1/2"x 1/2" x 600 mm ■ recommended: system with hose box see chapter "universal products"	<table border="1" style="width: 100%; border-collapse: collapse;"> <tr> <th>A</th> <th>B</th> <th>C</th> <th>D</th> <th>E</th> </tr> <tr> <td style="text-align: center;">308,-</td> <td></td> <td></td> <td></td> <td></td> </tr> </table>	A	B	C	D	E	308,-				
A	B	C	D	E									
308,-													

Badewanne, Aufputz-Batterien | Bath tub mixer sets, exposed

	129.20.100 Aufputz Wannenfüll- und Brausebatterie 1/2", mit Garnitur ■ Ausladung 145 mm ■ 2 keramische Oberteile 1/2" ■ Metall-Handbrause mit Anti-Kalk-System und Rückflussverhinderer ■ Metall-Brauseschlauch 1500 mm	Exposed tub/shower mixer 1/2", incl. shower set ■ spout projection 145 mm ■ 2 ceramic internal upper parts 1/2" ■ metal hand shower with anticalc. system and backflow preventer ■ metal shower hose 1500 mm	<table border="1" style="width: 100%; border-collapse: collapse;"> <tr> <th>A</th> <th>B</th> <th>C</th> <th>D</th> <th>E</th> </tr> <tr> <td style="text-align: center;">1.112,-</td> <td style="text-align: center;">1.312,-</td> <td style="text-align: center;">1.842,-</td> <td style="text-align: center;">2.073,-</td> <td style="text-align: center;">2.442,-</td> </tr> <tr> <th>F</th> <th>G</th> <th>H</th> <th>I</th> <th>L</th> </tr> <tr> <td style="text-align: center;">2.183,-</td> <td style="text-align: center;">1.798,-</td> <td style="text-align: center;">1.889,-</td> <td style="text-align: center;">2.659,-</td> <td style="text-align: center;">3.190,-</td> </tr> </table>	A	B	C	D	E	1.112,-	1.312,-	1.842,-	2.073,-	2.442,-	F	G	H	I	L	2.183,-	1.798,-	1.889,-	2.659,-	3.190,-
A	B	C	D	E																			
1.112,-	1.312,-	1.842,-	2.073,-	2.442,-																			
F	G	H	I	L																			
2.183,-	1.798,-	1.889,-	2.659,-	3.190,-																			

	129.20.140 Wannenfüll- und Brausebatterie für Standrohrmontage, mit Garnitur ■ Ausladung mit Standrohren 182 mm ■ 2 keramische Oberteile 1/2" ■ Metall-Handbrause mit Anti-Kalk-System und Rückflussverhinderer ■ Metall-Brauseschlauch 1500 mm	Tub/shower mixer for supply pipes, incl. shower set ■ spout projection with pipes 182 mm ■ 2 ceramic internal upper parts 1/2" ■ metal hand shower with anticalc. system and backflow preventer ■ metal shower hose 1500 mm	<table border="1" style="width: 100%; border-collapse: collapse;"> <tr> <th>A</th> <th>B</th> <th>C</th> <th>D</th> <th>E</th> </tr> <tr> <td style="text-align: center;">1.055,-</td> <td style="text-align: center;">1.246,-</td> <td style="text-align: center;">1.750,-</td> <td style="text-align: center;">1.970,-</td> <td style="text-align: center;">2.319,-</td> </tr> <tr> <th>F</th> <th>G</th> <th>H</th> <th>I</th> <th>L</th> </tr> <tr> <td style="text-align: center;">2.163,-</td> <td style="text-align: center;">1.708,-</td> <td style="text-align: center;">2.096,-</td> <td style="text-align: center;">2.529,-</td> <td style="text-align: center;">3.429,-</td> </tr> </table>	A	B	C	D	E	1.055,-	1.246,-	1.750,-	1.970,-	2.319,-	F	G	H	I	L	2.163,-	1.708,-	2.096,-	2.529,-	3.429,-
A	B	C	D	E																			
1.055,-	1.246,-	1.750,-	1.970,-	2.319,-																			
F	G	H	I	L																			
2.163,-	1.708,-	2.096,-	2.529,-	3.429,-																			

Benötigt | Required

	109.15.260 Wasserzufuhrstandrohre 1/2" ■ 2 Stück ■ in Boden einzuschrauben ■ inkl. Winkelstück zum Anschluß der Wannenfüll- und Brausebatterie ■ Höhe 775 - 800 mm	Water supply pipes 1/2" ■ 2 pieces ■ floor installation ■ incl. angle for connecting tub/shower mixer ■ height 775 - 800 mm	<table border="1" style="width: 100%; border-collapse: collapse;"> <tr> <th>A</th> <th>B</th> <th>C</th> <th>D</th> <th>E</th> </tr> <tr> <td style="text-align: center;">888,-</td> <td style="text-align: center;">1.282,-</td> <td style="text-align: center;">1.672,-</td> <td style="text-align: center;">1.882,-</td> <td style="text-align: center;">2.219,-</td> </tr> <tr> <th>F</th> <th>G</th> <th>H</th> <th>I</th> <th>L</th> </tr> <tr> <td style="text-align: center;">2.095,-</td> <td style="text-align: center;">1.632,-</td> <td style="text-align: center;">1.952,-</td> <td style="text-align: center;">2.525,-</td> <td style="text-align: center;">3.488,-</td> </tr> </table>	A	B	C	D	E	888,-	1.282,-	1.672,-	1.882,-	2.219,-	F	G	H	I	L	2.095,-	1.632,-	1.952,-	2.525,-	3.488,-
A	B	C	D	E																			
888,-	1.282,-	1.672,-	1.882,-	2.219,-																			
F	G	H	I	L																			
2.095,-	1.632,-	1.952,-	2.525,-	3.488,-																			

Empfohlen | Recommended

	109.10.970 Bausatz-Vormontage ■ Bodenplatte mit Befestigungsset ■ für Wasserzufuhrstandrohre 109.15.260	Assembly set for pre-installation ■ joint plate with fixing set ■ for water supply pipes 109.15.260	<table border="1" style="width: 100%; border-collapse: collapse;"> <tr> <th>A</th> <th>B</th> <th>C</th> <th>D</th> <th>E</th> </tr> <tr> <td style="text-align: center;">459,-</td> <td></td> <td></td> <td></td> <td></td> </tr> </table>	A	B	C	D	E	459,-				
A	B	C	D	E									
459,-													

Maßzeichnungen unter www.joerger.de - Menü SERVICE.
 Technical specifications under www.joerger.de - menu SERVICE.

A chrom chrome	[.000]	E platin matt platinum matt	[.066]
B silbernickel polished nickel	[.035]	F nerz matt milk matt	[.096]
C nerz milk	[.095]	G schwarz-matt black matt	[.092]
C nickel matt satin nickel	[.036]	G weiß-matt white matt	[.052]
D edelmessing sunshine	[.040]	H bronze bronze	[.011]
D platin platinum	[.065]	I gold gold	[.020]
E edelmess.matt sunshine matt	[.041]	L roségold rosegold	[.022]
E gold matt gold matt	[.021]	L roségold matt rosegold matt	[.023]

- 11 kristallklar | clear as crystal
- 12 schwarz | black

Die Artikelnummer wird um weitere 2 Ziffern erweitert. Beispiel:
 Waschtisch 3-Loch Batterie in chrom mit Hebelgriffen in kristallklar:

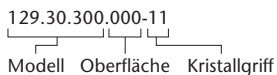

The article number needs to be added by 2 additional figures. For example:
 washbasin 3-hole mixer in chrome with lever handles in clear as crystal:

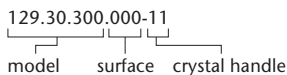

129.20.390 – Aufputz Set mit Steigrohr | Exposed set with shower system



649.13.920 Regenbrause ½“, ø 200 mm <ul style="list-style-type: none"> ■ Ausführung ganz in Metall ■ mit Kugelgelenk ■ Anti-Kalk-System 	Rain shower head ½“, ø 200 mm <ul style="list-style-type: none"> ■ full metal body ■ with ball joint ■ with anticalcareous system 	A	B	C	D	E
		260,-	619,-	824,-	895,-	1.268,-
		F	G	H	I	L
		1.085,-	821,-	1.098,-	1.389,-	2.189,-
649.20.810 Steigrohr, Umstellung, Wandarm <ul style="list-style-type: none"> ■ zum Anschluß an die Brausebatterie ■ Ausladung 595 - 615 mm ■ in der Neigung verstellbare Brausehalterung 	Supply pipe, diverter, wall bracket <ul style="list-style-type: none"> ■ to connect the exposed shower mixer ■ projection 595 - 615 mm ■ fitting for handshower adjustable in inclination 	A	B	C	D	E
		1.029,-	1.315,-	1.849,-	2.072,-	2.889,-
		F	G	H	I	L
		2.560,-	2.052,-	2.760,-	3.247,-	3.624,-
Variante Alternative						
649.20.830 Steigrohr, Umstellung, Wandarm <ul style="list-style-type: none"> ■ Ausladung 355 - 375 mm 	Supply pipe, diverter, wall bracket <ul style="list-style-type: none"> ■ projection 355 - 375 mm 	A	B	C	D	E
		226,-	396,-	416,-	467,-	569,-
		F	G	H	I	L
		508,-	544,-	745,-	832,-	1.328,-
109.13.700 Brausegarnitur <ul style="list-style-type: none"> ■ Metall-Handbrause mit Anti-Kalk-System und Rückflussverhinderer ■ Metall-Brauseschlauch 1500 mm, beidseitig mit drehbarem Konus 	Shower combination <ul style="list-style-type: none"> ■ metal hand shower with anticalc. system and backflow preventer ■ metal shower hose 1500 mm, both sides with turning cone 	A	B	C	D	E
		984,-	1.186,-	1.629,-	1.834,-	2.161,-
		F	G	H	I	L
		1.999,-	1.590,-	1.922,-	2.357,-	3.039,-
129.20.190 Aufputz-Wannenfüll- und Brausebatterie ½“, ohne Garnitur <ul style="list-style-type: none"> ■ für Steigrohr, Ausladung 145 mm ■ 2 keramische Oberteile ½“ 	Exposed tub/shower mixer ½“, without shower set <ul style="list-style-type: none"> ■ for supply pipe, projection 145 mm ■ 2 ceramic internal upper parts ½“ 	A	B	C	D	E
		594,-	728,-	799,-	897,-	1.057,-
		F	G	H	I	L
		958,-	999,-	1.259,-	1.285,-	2.289,-

Dusche, Aufputz-Batterien | Shower mixer sets, exposed



129.20.200 Brausebatterie ½“ für Aufputzmontage <ul style="list-style-type: none"> ■ 2 keramische Oberteile ½“ ■ verdeckte S-Anschlüsse ½“ x ¾“ 	Exposed shower mixer ½“ <ul style="list-style-type: none"> ■ 2 ceramic internal upper parts ½“ ■ concealed S-connections ½“ x ¾“ 	A	B	C	D	E
		976,-	1.326,-	1.469,-	1.577,-	2.132,-
		F	G	H	I	L
		1.907,-	1.549,-	1.911,-	2.390,-	2.813,-
129.20.250 Brausethermostat ½“ für Aufputzmontage <ul style="list-style-type: none"> ■ Dehnstoff-Thermoelement ■ Keramik-Innenoberteil ½“ 	Exposed shower thermostat ½“ <ul style="list-style-type: none"> ■ cartridge with thermoelement ■ ceramic cartridge ½“ 	A	B	C	D	E
		976,-	1.326,-	1.469,-	1.577,-	2.132,-
		F	G	H	I	L
		1.907,-	1.549,-	1.911,-	2.390,-	2.813,-

DELPHI DECO

Maßzeichnungen unter www.joerger.de - Menü SERVICE.
 Technical specifications under www.joerger.de - menu SERVICE.

A chrom chrome	[.000]	E platin matt platinum matt	[.066]
B silbernickel polished nickel	[.035]	F nerz matt mink matt	[.096]
C nerz mink	[.095]	G schwarz-matt black matt	[.092]
C nickel matt satin nickel	[.036]	G weiß-matt white matt	[.052]
D edelmessing sunshine	[.040]	H bronze bronze	[.011]
D platin platinum	[.065]	I gold gold	[.020]
E edelmess.matt sunshine matt	[.041]	L roségold rosegold	[.022]
E gold matt gold matt	[.021]	L roségold matt rosegold matt	[.023]

- 11 kristallklar | clear as crystal
- 12 schwarz | black

Die Artikelnummer wird um weitere 2 Ziffern erweitert. Beispiel:
 Waschtisch 3-Loch Batterie in chrom mit Hebelgriffen in kristallklar:

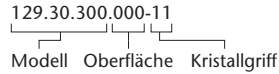

The article number needs to be added by 2 additional figures. For example:
 washbasin 3-hole mixer in chrome with lever handles in clear as crystal:

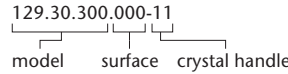

129.20.410 – Aufputz Set mit Steigrohr | Exposed set with shower system



- 649.13.920 Regenbrause 1/2", ø 200 mm
- Ausführung ganz in Metall
 - mit Kugelgelenk

- Rain shower head 1/2", ø 200 mm
- full metal body
 - with ball joint

A	B	C	D	E
260,-	619,-	824,-	895,-	1.268,-
F	G	H	I	L
1.085,-	821,-	1.098,-	1.389,-	2.189,-

- 649.20.280 Steigrohr, Umstellung, Wandarm
- zum Anschluß an die Brausebatterie
 - Ausladung 360 - 380 mm
 - in der Neigung und Höhe verstellbare Brausehalterung

- Supply pipe, diverter, wall bracket
- to connect the exposed shower mixer
 - projection 360 - 380 mm
 - fitting for handshower adjustable in height and inclination

A	B	C	D	E
589,-	932,-	1.198,-	1.362,-	1.741,-
F	G	H	I	L
1.599,-	1.318,-	1.649,-	1.895,-	2.529,-

- 109.13.700 Brausegarnitur
- Metall-Handbrause mit Anti-Kalk-System und Rückflussverhinderer
 - Metall-Brauseschlauch 1500 mm, beidseitig mit drehbarem Konus

- Shower combination
- metal hand shower with anticalc. system and backflow preventer
 - metal shower hose 1500 mm, both sides with turning cone

A	B	C	D	E
226,-	396,-	416,-	467,-	569,-
F	G	H	I	L
508,-	544,-	745,-	832,-	1.328,-

- 129.20.210 Aufputz-Brausebatterie 1/2"
- für Steigrohr, Brauseabgang 3/4"

- Exposed shower mixer 1/2"
- for supply pipe, discharge 3/4"

A	B	C	D	E
594,-	728,-	799,-	897,-	1.057,-
F	G	H	I	L
958,-	999,-	1.259,-	1.285,-	2.289,-

129.20.460 – Aufputz Set mit Steigrohr | Exposed set with shower system



- 649.13.920 Regenbrause 1/2", ø 200 mm
- Ausführung ganz in Metall
 - mit Kugelgelenk

- Rain shower head 1/2", ø 200 mm
- full metal body
 - with ball joint

A	B	C	D	E
260,-	619,-	824,-	895,-	1.268,-
F	G	H	I	L
1.085,-	821,-	1.098,-	1.389,-	2.189,-

- 649.20.280 Steigrohr, Umstellung, Wandarm
- zum Anschluß an die Brausebatterie
 - Ausladung 360 - 380 mm
 - in der Neigung und Höhe verstellbare Brausehalterung

- Supply pipe, diverter, wall bracket
- to connect the exposed shower mixer
 - projection 360 - 380 mm
 - fitting for handshower adjustable in height and inclination

A	B	C	D	E
589,-	932,-	1.198,-	1.362,-	1.741,-
F	G	H	I	L
1.599,-	1.318,-	1.649,-	1.895,-	2.529,-

- 109.13.700 Brausegarnitur
- Metall-Handbrause mit Anti-Kalk-System und Rückflussverhinderer
 - Metall-Brauseschlauch 1500 mm, beidseitig mit drehbarem Konus

- Shower combination
- metal hand shower with anticalc. system and backflow preventer
 - metal shower hose 1500 mm, both sides with turning cone

A	B	C	D	E
226,-	396,-	416,-	467,-	569,-
F	G	H	I	L
508,-	544,-	745,-	832,-	1.328,-

- 129.20.260 Aufputz-Brausethermostat 1/2"
- für Steigrohr, Brauseabgang 3/4"

- Exposed shower thermostat 1/2"
- for supply pipe, discharge 3/4"

A	B	C	D	E
1.024,-	1.374,-	1.517,-	1.625,-	2.180,-
F	G	H	I	L
1.955,-	1.597,-	1.959,-	2.438,-	2.861,-

Maßzeichnungen unter www.joerg.de - Menü SERVICE.
 Technical specifications under www.joerg.de - menu SERVICE.

A chrom chrome	[.000]	E platin matt platinum matt	[.066]
B silbernickel polished nickel	[.035]	F nerz matt milk matt	[.096]
C nerz milk	[.095]	G schwarz-matt black matt	[.092]
C nickel matt satin nickel	[.036]	G weiß-matt white matt	[.052]
D edelmessing sunshine	[.040]	H bronze bronze	[.011]
D platin platinum	[.065]	I gold gold	[.020]
E edelmess.matt sunshine matt	[.041]	L roségold rosegold	[.022]
E gold matt gold matt	[.021]	L roségold matt rosegold matt	[.023]

- 11 kristallklar | clear as crystal
- 12 schwarz | black

Die Artikelnummer wird um weitere 2 Ziffern erweitert. Beispiel:
 Waschtisch 3-Loch Batterie in chrom mit Hebelgriffen in kristallklar:

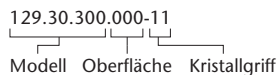

The article number needs to be added by 2 additional figures. For example:
 washbasin 3-hole mixer in chrome with lever handles in clear as crystal:

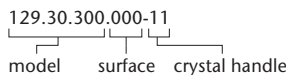

Unterputz-Hebelmischer 1/2" | Concealed single lever mixer 1/2"



- 129.20.125 1-Hand Wannenfüll- und Brausebatterie 1/2" für UP-Montage, Fertigmontageset
- manuelle, keramische Umstellung für druckunabhängige Funktion
 - mit Sicherheitseinrichtung

- Concealed single lever wall tub and shower mixer 1/2", assembly set
- manual, ceramic diverter tub/shower for pressure-independent function
 - with safety device

A	B	C	D	E
1.068,-	1.269,-	1.383,-	1.423,-	1.720,-
F	G	H	I	L
1.579,-	1.350,-	1.348,-	1.799,-	1.952,-

Variante | Alternative



- 129.20.235 1-Hand Brausebatterie 1/2" für UP-Montage, Fertigmontageset
- ohne Umstellung
 - Funktionseinheit mit ker. Scheiben

- Concealed single lever shower mixer 1/2", assembly set
- without diverter
 - functional unit with ceramic discs

A	B	C	D	E
812,-	1.049,-	1.157,-	1.187,-	1.459,-
F	G	H	I	L
1.324,-	1.129,-	1.069,-	1.539,-	1.669,-

Benötigt | Required



- 649.40.360 Unterputz-Einbaubox 1/2"
- zu Fertigmontageset 129.20.125 und 129.20.235
 - für Nass- und Trockenbau geeignet

- Concealed wall box 1/2"
- for assembly set 129.20.125 and 129.20.235
 - for wetwall and drywall construction

A	B	C	D	E
168,-				

Unterputz-Thermostate 1/2" | Wall thermostats, concealed 1/2"



- 109.40.380 Unterputz-Thermostat 1/2" mit Mengenregulierung, Fertigmontageset
- manuelle, keramische Umstellung Wanne/Brause, druckunabhängig
 - mit Sicherheitseinrichtung

- Concealed wall thermostat 1/2" with flow control, assembly set
- manual, ceramic diverter tub/shower for pressure-independent function
 - with safety device

A	B	C	D	E
1.092,-	1.294,-	1.476,-	1.522,-	1.805,-
F	G	H	I	L
1.698,-	1.476,-	1.742,-	1.978,-	2.468,-

Variante | Alternative



- 109.40.360 Unterputz-Thermostat 1/2" mit Mengenregulierung, Fertigmontageset
- ohne Umstellung
 - mit integrierter keramischer Mengenregulierung

- Concealed wall thermostat 1/2" with flow control, assembly set
- without diverter
 - with integrated ceramic cartridge for volume control

A	B	C	D	E
1.082,-	1.284,-	1.441,-	1.487,-	1.771,-
F	G	H	I	L
1.688,-	1.441,-	1.708,-	1.968,-	2.458,-

Variante | Alternative



- 109.40.460 Unterputz-Thermostat 1/2" ohne Mengenregulierung, Fertigmontageset
- Funktionseinheit ohne Umstellung und ohne Absperrung

- Concealed wall thermostat 1/2" without flow control, assembly set
- Functional unit without diverter and without shut-off

A	B	C	D	E
874,-	1.018,-	1.214,-	1.334,-	1.664,-
F	G	H	I	L
1.509,-	1.212,-	1.455,-	1.834,-	2.118,-

Benötigt | Required



- 649.40.360 Unterputz-Einbaubox 1/2"
- zu Fertigmontageset 109.40.360, 109.40.380 und 109.40.460
 - für Nass- und Trockenbau geeignet

- Concealed wall box 1/2"
- for assembly set 109.40.360, 109.40.380 and 109.40.460
 - for wetwall and drywall construction

A	B	C	D	E
168,-				

Unterputz-Thermostat 3/4" | Wall thermostat, concealed 3/4"



- 129.40.560 Unterputz-Thermostat 3/4" ohne Mengenregulierung, Fertigmontageset
- serienbezogener Temperiergriff
 - Sicherheitssperre bei 38°C

- Concealed wall thermostat 3/4" without flow control, assembly set
- design handle for temp. control
 - locking device at 38°C

A	B	C	D	E
529,-	784,-	906,-	944,-	1.213,-
F	G	H	I	L
1.084,-	884,-	869,-	1.349,-	1.476,-

Benötigt | Required



- 649.40.555 Unterputz-Einbaukörper 3/4"
- zu Fertigmontageset 129.40.560
 - Kartusche mit Schmutzfangsieben
 - für Nass- und Trockenbau geeignet

- Concealed thermostat body 3/4"
- for assembly set 129.40.560
 - cartridge with filter screens
 - for wetwall and drywall construction

A	B	C	D	E
1.636,-				

Maßzeichnungen unter www.joerger.de - Menü SERVICE.
 Technical specifications under www.joerger.de - menu SERVICE.

A chrom chrome	[.000]	E platin matt platinum matt	[.066]
B silbernickel polished nickel	[.035]	F nerz matt milk matt	[.096]
C nerz milk	[.095]	G schwarz-matt black matt	[.092]
C nickel matt satin nickel	[.036]	G weiß-matt white matt	[.052]
D edelmessing sunshine	[.040]	H bronze bronze	[.011]
D platin platinum	[.065]	I gold gold	[.020]
E edelmess.matt sunshine matt	[.041]	L roségold rosegold	[.022]
E gold matt gold matt	[.021]	L roségold matt rosegold matt	[.023]

- 11 kristallklar | clear as crystal
- 12 schwarz | black

Die Artikelnummer wird um weitere 2 Ziffern erweitert. Beispiel:
 Waschtisch 3-Loch Batterie in chrom mit Hebelgriffen in kristallklar:

129.30.300.000-11
 Modell Oberfläche Kristallgriff

The article number needs to be added by 2 additional figures. For example:
 washbasin 3-hole mixer in chrome with lever handles in clear as crystal:

129.30.300.000-11
 model surface crystal handle

Unterputz-Thermostat/Ventil-Modul | Concealed thermostatic/wall-valve modul



129.60.432 Unterputz-Ventil-Modul Fertigmontageset
 ■ Griff
 ■ Schubrosette, Hülse

Concealed wall-valve-modul assembly set
 ■ design handle
 ■ socket with adjustable escutcheon

A	B	C	D	E
309,-	364,-	389,-	451,-	542,-
F	G	H	I	L
497,-	389,-	469,-	592,-	659,-

Benötigt | Required



649.20.610 Unterputz-Ventil-Modul, 1-fach
 ■ 1x Spindelventil 3/4", rechtsschließend mit keram. Scheiben
 ■ 2 Abgänge 1/2", je 1x rechts/links möglich, gleichzeitig benutzbar

Concealed wall-valve-modul, single
 ■ 1x spindle valve 3/4", clockwise closure with ceramic discs
 ■ 2 outlets 1/2", each 1x right/left possible, simultaneously usable

A				
229,-				



649.20.620 Unterputz-Ventil-Modul, 2-fach
 ■ 2x Spindelventil 3/4", rechtsschließend mit keram. Scheiben
 ■ 4 Abgänge 1/2", je 2x rechts/links möglich, gleichzeitig benutzbar
 ■ im Verbund maßgenaue Montage
 ■ erweiterbar mit 649.20.610

Concealed wall-valve-modul, double
 ■ 2x spindle valve 3/4", clockwise closure with ceramic discs
 ■ 4 outlets 1/2", each 2x right/left possible, simultaneously usable
 ■ precise assembly due to composite
 ■ expandable with 649.20.610

A				
458,-				



649.20.630 Unterputz-Ventil-Modul, 3-fach
 ■ 3x Spindelventil 3/4", rechtsschließend mit keram. Scheiben
 ■ 6 Abgänge 1/2", je 3x rechts/links möglich, gleichzeitig benutzbar
 ■ im Verbund maßgenauen Montage
 ■ erweiterbar mit 649.20.610

Concealed wall-valve-modul, triple
 ■ 3x spindle valve 3/4", clockwise closure with ceramic discs
 ■ 6 outlets 1/2", each 3x right/left possible, simultaneously usable
 ■ precise assembly due to composite
 ■ expandable with 649.20.610

A				
686,-				



109.40.460 Unterputz-Thermostat 1/2" ohne Mengenregulierung, Fertigmontageset
 ■ Funktionseinheit ohne Umstellung und ohne Absperrung
 ■ Durchflussrate 25,8 l/min bei 3 bar

Concealed wall thermostat 1/2" without flow control, assembly set
 ■ Functional unit without diverter and without shut-off
 ■ flow rate 25,8 l/min at 3 bar

A	B	C	D	E
874,-	1.018,-	1.214,-	1.334,-	1.664,-
F	G	H	I	L
1.509,-	1.212,-	1.455,-	1.834,-	2.118,-

Benötigt | Required



649.20.612 Anschlußadapter 1/2"
 ■ Anschlußadapter, Abschlußstopfen
 ■ passend zu Einbaubox 649.40.360

Connection adapter 1/2"
 ■ connection adapter, end plug
 ■ matching to wall box 649.40.360

A				
122,-				



649.40.360 Unterputz-Einbaubox 1/2"
 ■ zu Fertigmontageset 109.40.460
 ■ für Nass- und Trockenbau geeignet

Concealed wall box 1/2"
 ■ for assembly set 109.40.460
 ■ for wetwall and drywall construction

A				
168,-				

Maßzeichnungen unter www.joerger.de - Menü SERVICE.
 Technical specifications under www.joerger.de - menu SERVICE.

A chrom chrome	[.000]	E platin matt platinum matt	[.066]
B silbernickel polished nickel	[.035]	F nerz matt mink matt	[.096]
C nerz mink	[.095]	G schwarz-matt black matt	[.092]
C nickel matt satin nickel	[.036]	G weiß-matt white matt	[.052]
D edelmessing sunshine	[.040]	H bronze bronze	[.011]
D platin platinum	[.065]	I gold gold	[.020]
E edelmess.matt sunshine matt	[.041]	L roségold rosegold	[.022]
E gold matt gold matt	[.021]	L roségold matt rosegold matt	[.023]

- 11 kristallklar | clear as crystal
- 12 schwarz | black

Die Artikelnummer wird um weitere 2 Ziffern erweitert. Beispiel:
 Waschtisch 3-Loch Batterie in chrom mit Hebelgriffen in kristallklar:

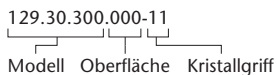

The article number needs to be added by 2 additional figures. For example:
 washbasin 3-hole mixer in chrome with lever handles in clear as crystal:

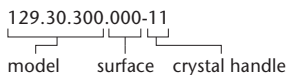

129.40.560 Unterputz-Thermostat ¾" ohne Mengenregulierung, Fertigmontageset
 ■ serienbezogener Temperiergriff
 ■ Sicherheitssperre bei 38° C

Concealed wall thermostat ¾" without flow control, assembly set
 ■ design handle for temp. control
 ■ locking device at 38° C

A	B	C	D	E
529,-	784,-	906,-	944,-	1.213,-
F	G	H	I	L
1.084,-	884,-	869,-	1.349,-	1.476,-

Benötigt | Required

649.20.634 Anschlußadapter ¾"
 ■ Anschlußadapter, Abschlußstopfen
 ■ passend zu Einbaukörper 649.40.555



Connection adapter ¾"
 ■ connection adapter, end plug
 ■ matching to wall body 649.40.555

A	B	C	D	E
146,-				



649.40.555 Unterputz-Einbaukörper ¾"
 ■ zu Fertigmontageset 615.40.555
 ■ Kartusche mit Schmutzfangsieben
 ■ für Nass- und Trockenbau geeignet
 ■ Durchflußrate 64,2 l/min bei 3 bar
 ■ ohne Absperrung

Concealed thermostat body ¾"
 ■ for assembly set 615.40.555
 ■ cartridge with filter screens
 ■ for wetwall and drywall construction
 ■ flow rate 64,2 l/min at 3 bar
 ■ without shut-off

A	B	C	D	E
1.636,-				

Unterputz-Umstellung und Ventile | Diverter and valves concealed



129.40.650 Unterputz 3-Wege Umstellung ½" Fertigmontageset
 ■ Griff
 ■ Hülse, Schubrosette

Concealed 3-position diverter ½" assembly set
 ■ design handle
 ■ socket with adjustable escutcheon

A	B	C	D	E
348,-	399,-	428,-	496,-	596,-
F	G	H	I	L
547,-	456,-	529,-	651,-	725,-

Benötigt | Required

649.40.600 Unterputz 3-Wege Umstellung ½" Einbaukörper
 ■ zu Fertigmontageset 129.40.650

Concealed 3-position diverter ½" diverter body
 ■ for assembly set 129.40.650

A	B	C	D	E
236,-				



129.50.234 Unterputz-Ventil Fertigmontageset
 ■ Griff
 ■ Hülse, Schubrosette

Concealed wall valve assembly set
 ■ design handle
 ■ socket with adjustable escutcheon

A	B	C	D	E
278,-	320,-	342,-	398,-	478,-
F	G	H	I	L
438,-	398,-	476,-	586,-	674,-

Benötigt | Required

649.20.350 Unterputz-Ventil ½", Einbaukörper
 ■ rechtsschließend, ker. Scheiben

Concealed wall valve ½", body
 ■ clockwise closure, ceramic discs

A	B	C	D	E
66,-				



649.20.355 Unterputz-Ventil ½", Einbaukörper
 ■ linksschließend, ker. Scheiben

Concealed wall valve ½", body
 ■ counter-clockwise closure, cer. discs

A	B	C	D	E



649.20.450 Unterputz-Ventil ¾", Einbaukörper
 ■ rechtsschließend, ker. Scheiben

Concealed wall valve ¾", body
 ■ clockwise closure, ceramic discs

A	B	C	D	E
99,-				

649.20.455 Unterputz-Ventil ¾", Einbaukörper
 ■ linksschließend, ker. Scheiben

Concealed wall valve ¾", body
 ■ counter-clockwise closure, cer. discs

A	B	C	D	E

DELPHI DECO

Maßzeichnungen unter www.joerger.de - Menü SERVICE.
 Technical specifications under www.joerger.de - menu SERVICE.

A chrom chrome	[.000]	E platin matt platinum matt	[.066]
B silbernickel polished nickel	[.035]	F nerz matt mink matt	[.096]
C nerz mink	[.095]	G schwarz-matt black matt	[.092]
C nickel matt satin nickel	[.036]	G weiß-matt white matt	[.052]
D edelmessing sunshine	[.040]	H bronze bronze	[.011]
D platin platinum	[.065]	I gold gold	[.020]
E edelmess.matt sunshine matt	[.041]	L roségold rosegold	[.022]
E gold matt gold matt	[.021]	L roségold matt rosegold matt	[.023]

Brausen | Showers

	109.13.300 Duschgarnitur, komplett <ul style="list-style-type: none"> Wandrohr 900 mm, mit Schieber Metall-Handbrause mit Anti-Kalk-System und Rückflussverhinderer Metall-Brauseschlauch 1750 mm, beidseitig mit drehbarem Konus 	Shower bar set, complete <ul style="list-style-type: none"> wall bar 900 mm, with slider metal hand shower with anticalc. system and backflow preventer metal shower hose 1750 mm, both sides with turning cone 	A	B	C	D	E	
				498,-	884,-	1.098,-	1.179,-	1.598,-
				F	G	H	I	L
			1.484,-	1.179,-	1.734,-	1.916,-	2.926,-	
	109.13.200 Schlauchbrausegarnitur <ul style="list-style-type: none"> Wandanschlußbogen 1/2", Schubrosette, Wand-Brausehalter Metall-Handbrause mit Anti-Kalk-System und Rückflussverhinderer Metall-Brauseschlauch 1500 mm 	Shower combination <ul style="list-style-type: none"> wall elbow connection 1/2" wall fitting for hand shower metal hand shower with anticalc. system and backflow preventer flexible metal shower hose 1500 mm 	A	B	C	D	E	
				364,-	486,-	596,-	672,-	862,-
				F	G	H	I	L
			772,-	755,-	1.075,-	1.069,-	1.610,-	
	649.13.615 Stachelkopfbrause 1/2" <ul style="list-style-type: none"> ø 230 mm, 75 Düsen Metall, Anti-Kalk-System Brausekopf schwenkbar ohne Wandarm 	Body spray shower head 1/2" <ul style="list-style-type: none"> ø 230 mm, 75 jets full metal, anticalcareous system swivel shower head without wall bracket 	A	B	C	D	E	
				969,-	1.232,-	1.359,-	1.416,-	1.659,-
				F	G	H	I	L
			1.496,-	1.399,-	1.718,-	2.262,-	2.739,-	
Empfohlen Recommended								
	649.13.625 Wandarm 1/2" <ul style="list-style-type: none"> Ausladung 162 mm 	Wall bracket 1/2" <ul style="list-style-type: none"> projection 162 mm 	A	B	C	D	E	
				126,-	145,-	171,-	189,-	250,-
				F	G	H	I	L
			229,-	192,-	296,-	286,-	499,-	
	109.13.237 Hygienebrausegarnitur <ul style="list-style-type: none"> Wandbrausehalter und -anschlußbogen 1/2", Schubrosette Hygienebrause, klassisch (649.13.338), komplett aus Metall einstrahlig, Bedienung über Druckhebel Metall-Brauseschlauch 1250 mm 	Ablution spray combination <ul style="list-style-type: none"> wall fitting and elbow connection 1/2" spray handshower, classical (649.13.338), completely metal one jet, push-lever operation flexible metal shower hose 1250 mm 	A	B	C	D	E	
				309,-	473,-	598,-	629,-	859,-
				F	G	H	I	L
			739,-	659,-	996,-	1.049,-	1.529,-	
	129.20.237 1-Hand Batterie 1/2" für Hygiene-Brause, Fertigmontageset <ul style="list-style-type: none"> Rosette, Griff mit Kristallgriff 	Concealed single lever 1/2" for ablution spray, assembly set <ul style="list-style-type: none"> escutcheon, handle with crystal handle 	A	B	C	D	E	
				319,-	429,-	529,-	595,-	699,-
				F	G	H	I	L
			648,-	549,-	624,-	814,-	929,-	
Benötigt Required								
	649.20.237 Unterputz 1-Hand Batterie 1/2", Einbaukörper <ul style="list-style-type: none"> Kartusche mit keramischen Scheiben zu Fertigmontageset 129.20.237 	Single lever mixer 1/2", concealed body <ul style="list-style-type: none"> cartridge with ceramic discs for assembly set 129.20.237 	A	B	C	D	E	
				125,-	169,-	208,-	229,-	268,-
				F	G	H	I	L
			249,-	224,-	258,-	329,-	396,-	
	649.13.519 Seitenbrause 1/2" <ul style="list-style-type: none"> Rosette ø 130 mm, Wandmontage Brausekopf schwenkbar, 20° Anti-Kalk-System Ausführung: Kunststoff 	Body spray side shower 1/2" <ul style="list-style-type: none"> escutcheon ø 130 mm, wall assembly swivel shower head, 20° anticalcareous system plastic 	A	B	C	D	E	
				167,-	326,-	385,-	399,-	542,-
				F	G	H	I	L
			496,-	376,-	472,-	634,-	949,-	



Oberflächen | colours

Folgende Oberflächen sind bei dieser Serie möglich |
The following colours are possible with this collection

chrom	chrome	[.000]	PG A
silbernickel	polished nickel	[.035]	PG B
nerz	mink	[.095]	PG C
nickel matt	satin nickel	[.036]	PG C
edelmessing	sunshine	[.040]	PG D
platin	platinum	[.065]	PG D
edelmessing matt	sunshine matt	[.041]	PG E
gold matt	gold matt	[.021]	PG E
platin matt	platinum matt	[.066]	PG E
schwarz matt	black matt	[.092]	PG G
weiß matt	white matt	[.052]	PG G
bronze	bronze	[.011]	PG H
gold	gold	[.020]	PG I
alt-gold	antique-gold	[.025]	PG K
roségold	rosegold	[.022]	PG L
roségold matt	rosegold matt	[.023]	PG L

Andere Oberflächen auf Anfrage |
Different colours on request

Auf Anfrage können wir Produkte von Drittanbietern auch gerne passend zu unseren Oberflächen veredeln (vorbehaltlich der Eignungsprüfung) | Third-party products may be plated matching to our colours on request (subject to valuation of suitability)

Waschtisch | Washbasin

ab Seite | from page 184

Bidet | Bidet

ab Seite | from page 184

Wanne | Bath tub

ab Seite | from page 185

Dusche | Shower

ab Seite | from page 187

Accessoires | Accessories

ab Seite | from page 194

CRONOS

Maßzeichnungen unter www.joerger.de - Menü SERVICE.
 Technical specifications under www.joerger.de - menu SERVICE.

A chrom chrome	[.000]	E platin matt platinum matt	[.066]
B silbernickel polished nickel	[.035]	G schwarz-matt black matt	[.092]
C nerz milk	[.095]	G weiß-matt white matt	[.052]
C nickel matt satin nickel	[.036]	H bronze bronze	[.011]
D edelmessing sunshine	[.040]	I gold gold	[.020]
D platin platinum	[.065]	K alt-gold antique-gold	[.025]
E edelmess.matt sunshine matt	[.041]	L roségold rosegold	[.022]
E gold matt gold matt	[.021]	L roségold matt rosegold matt	[.023]

Waschtisch Batterien | Washbasin mixer



637.30.305 Waschtisch 3-Loch Batterie 1/2"
 ■ mit Hebelgriffen
 ■ Ausladung 160 mm; Höhe 280 mm
 ■ 2 Seitenrandventile mit keramischen Oberteilen 1/2", rechts und links schließend
 ■ Ablaufventil mit Klickverschluss 1 1/4"
 ■ empfohlen:
 2x 649.15.530 - Kupferrohr 300 mm

Washbasin 3-hole mixer 1/2"
 ■ with lever handles
 ■ spout projection 160 mm; height 280 mm
 ■ 2 side valves with ceramic internal upper parts 1/2", clockwise and counter-clockwise closure
 ■ push-open waste 1 1/4"
 ■ recommended:
 2x 649.15.530 - copper tube 300 mm

A	B	C	D	E
1.199,-	1.434,-	1.576,-	1.774,-	2.088,-
G	H	I	K	L
1.732,-	1.994,-	2.574,-	2.832,-	3.465,-

Griffvariante | Handle alternative



637.30.300 Waschtisch 3-Loch Batterie 1/2"
 ■ mit Kreuzgriffen

Washbasin 3-hole mixer 1/2"
 ■ with cross handles

Wand-Waschtisch 3-Loch Batterie | Wall-Washbasin 3-hole mixer



637.30.365 Wand-Waschtisch 3-Loch Batterie 1/2", Fertigmontageset
 ■ mit Hebelgriffen
 ■ Wand-Auslauf, Ausladung 200 - 212 mm
 ■ Griff, Rosette
 ■ Oberteile 1/2", keramische Scheiben

Wall washbasin 3-hole mixer 1/2" assembly set
 ■ with lever handles
 ■ wall spout, projection 200 - 212 mm
 ■ design handle, escutcheon
 ■ cartridges 1/2", with ceramic discs

A	B	C	D	E
1.116,-	1.239,-	1.342,-	1.382,-	1.625,-
G	H	I	K	L
1.445,-	1.665,-	2.172,-	2.390,-	2.878,-

Griffvariante | Handle alternative



637.30.360 Wand-Waschtisch 3-Loch Batterie 1/2", Fertigmontageset
 ■ mit Kreuzgriffen

Wall washbasin 3-hole mixer 1/2" assembly set
 ■ with cross handles

Benötigt | Required



649.30.380 Wand-Waschtisch 3-Loch Batterie 1/2", Einbaukörper
 ■ 2 Anschlüsse, Stichmaß 204 mm
 ■ zu Fertigmontageset 637.30.360 und 637.30.365

Wall washbasin 3-hole mixer 1/2" concealed body
 ■ 2 connections, center distance 204 mm
 ■ for assembly set 637.30.360 and 637.30.365

A	B	C	D	E
296,-				

Bidet Batterien | Bidet mixer



637.10.105 Bidet 1-Loch Batterie 1/2"
 ■ mit Hebelgriffen
 ■ Ausladung 125 mm; Höhe 160 mm
 ■ Exzenter-Ablaufgarnitur 1 1/4"
 ■ 2 Kupferrohre M10x1 x 400 mm

Bidet 1-hole mixer 1/2"
 ■ with lever handles
 ■ spout projection 125 mm; height 160 mm
 ■ pop-up waste 1 1/4"
 ■ 2 copper tubes M10x1 x 400 mm

A	B	C	D	E
1.153,-	1.299,-	1.364,-	1.463,-	1.822,-
G	H	I	K	L
1.464,-	1.659,-	2.245,-	2.470,-	2.846,-

Griffvariante | Handle alternative



637.10.100 Bidet 1-Loch Batterie 1/2"
 ■ mit Kreuzgriffen

Bidet 1-hole mixer 1/2"
 ■ with cross handles

CRONOS

Maßzeichnungen unter www.joerger.de - Menü SERVICE.
 Technical specifications under www.joerger.de - menu SERVICE.

A chrom chrome	[.000]	E platin matt platinum matt	[.066]
B silbernickel polished nickel	[.035]	G schwarz-matt black matt	[.092]
C nerz milk	[.095]	G weiß-matt white matt	[.052]
C nickel matt satin nickel	[.036]	H bronze bronze	[.011]
D edelmessing sunshine	[.040]	I gold gold	[.020]
D platin platinum	[.065]	K alt-gold antique-gold	[.025]
E edelmess.matt sunshine matt	[.041]	L roségold rosegold	[.022]
E gold matt gold matt	[.021]	L roségold matt rosegold matt	[.023]

Zubehör für Waschtisch- und Bidet-Batterien | Supplies for washbasin and bidet mixer

	637.12.105 Eckventil ½" ■ mit Hebelgriff ■ Ausladung 106 mm ■ Fettkammer-Innenoberteil ½" ■ Quetschverschraubung ■ Schubrossette	Angle valve ½" ■ with lever handle ■ projection 106 mm ■ cartridge ½" ■ compression joint ■ escutcheon	A	B	C	D	E
			324,-	377,-	399,-	435,-	586,-
			G	H	I	K	L
			445,-	599,-	696,-	766,-	848,-

Griffvariante | Handle alternative

	637.12.100 Eckventil ½" ■ mit Kreuzgriff	Angle valve ½" ■ with cross handle	A	B	C	D	E

	649.15.530 Kupferrohr, 300 mm ■ mit Bördel, für Quetschverschraubung	Copper tube, 300 mm ■ with flange, for compression joint	A	B	C	D	E
			15,-	38,-	55,-	62,-	74,-
			G	H	I	K	L
			75,-	94,-	112,-	124,-	169,-

Variante | Alternative

	649.15.550 Kupferrohr, 500 mm ■ mit Bördel, für Quetschverschraubung	Copper tube, 500 mm ■ with flange, for compression joint	A	B	C	D	E
			20,-	58,-	77,-	87,-	102,-
			G	H	I	K	L
			77,-	96,-	134,-	148,-	219,-

	649.15.340 Waschtisch-Tassensiphon 1 ¼" ■ schwere Ausführung ■ Rosette ■ Abgangsrohr ø 32 mm ■ Tauchrohrlänge 165 mm	Washbasin cupped siphon trap 1 ¼" ■ heavy brass ■ escutcheon ■ outlet tube ø 32 mm ■ dip pipe 165 mm	A	B	C	D	E
			195,-	296,-	368,-	429,-	568,-
			G	H	I	K	L
			378,-	539,-	686,-	755,-	832,-

	649.15.330 Bidet-Tassensiphon 1 ¼" ■ Rosette ■ Abgangsrohr ø 32 mm	Bidet cupped siphon trap 1 ¼" ■ escutcheon ■ outlet tube ø 32 mm	A	B	C	D	E
			98,-	166,-	276,-	332,-	472,-
			G	H	I	K	L
			364,-	508,-	648,-	713,-	796,-

Badewanne, Stand-Batterien | Bath tub mixer sets, deck mount

	637.40.107 4-Loch Wannenfüll- u. Brause- batterie ½", Standmontage ■ mit Hebelgriffen ■ Ausladung 172 mm; Höhe 275 mm ■ 2 Seitenrandventile mit keramischen Oberteilen ½" ■ Metall-Brauseschlauch 2000 mm ■ Metall-Handbrause mit Anti-Kalk- System und Rückflussverhinderer	Tub/shower mixer set ½" deck mount ■ with lever handles ■ spout projection 172 mm; height 275 mm ■ 2 side valves, ceramic internal upper parts ½" ■ metal shower hose 2000 mm ■ metal hand shower with anticalc. system and backflow preventer	A	B	C	D	E
			2.035,-	2.274,-	2.460,-	2.768,-	3.260,-
			G	H	I	K	L
			2.348,-	3.032,-	3.829,-	4.212,-	4.925,-

Griffvariante | Handle alternative

	637.40.102 4-Loch Wannenfüll- u. Brause- batterie ½", Standmontage ■ mit Kreuzgriffe	Tub/shower mixer set ½" deck mount ■ with cross handles	A	B	C	D	E

CRONOS

Maßzeichnungen unter www.joerger.de - Menü SERVICE.
 Technical specifications under www.joerger.de - menu SERVICE.

A chrom chrome	[.000]	E platin matt platinum matt	[.066]
B silbernickel polished nickel	[.035]	G schwarz-matt black matt	[.092]
C nerz milk	[.095]	G weiß-matt white matt	[.052]
C nickel matt satin nickel	[.036]	H bronze bronze	[.011]
D edelmessing sunshine	[.040]	I gold gold	[.020]
D platin platinum	[.065]	K alt-gold antique-gold	[.025]
E edelmess.matt sunshine matt	[.041]	L roségold rosegold	[.022]
E gold matt gold matt	[.021]	L roségold matt rosegold matt	[.023]

	637.40.157 4-Loch Wannenrandkombi 1/2" <ul style="list-style-type: none"> mit Hebelgriffen für Ab- und Überlaufgarnitur mit Wanneneinlauf, ohne Rohrunterbrecher Seitenrandventile, 2-Wege Umstellung Metall-Brauseschlauch 2000 mm Metall-Handbrause mit Anti-Kalk-System und Rückflussverhinderer 	Tub/shower combination 1/2" <ul style="list-style-type: none"> with lever handles for waste and overflow set with bath tub filler spout, without pipe interrupter side valves, 2-position diverter metal shower hose 2000 mm metal hand shower with anticalc. system and backflow preventer 	A	B	C	D	E	
				1.609,-	2.209,-	2.345,-	2.532,-	2.939,-
				G	H	I	K	L
				2.195,-	2.785,-	3.296,-	3.626,-	4.615,-

Griffvariante | Handle alternative

	637.40.152 4-Loch Wannenrandkombi 1/2" <ul style="list-style-type: none"> mit Kreuzgriffen 	Tub/shower combination 1/2" <ul style="list-style-type: none"> with cross handles 					

Empfohlen | Recommended

	649.40.160 Montageplatte, komplett <ul style="list-style-type: none"> für 4-Loch Armaturen Druckschläuche 1/2" x 1/2" x 600 mm empfohlen: Schlauchkastensystem siehe Kapitel "Serienübergreifendes" 	Assembly plate, complete <ul style="list-style-type: none"> for deck mounted tub/shower mixer pressure hoses 1/2" x 1/2" x 600 mm recommended: system with hose box see chapter "universal products" 	A				
				308,-			

Badewanne, Aufputz-Batterien | Bath tub mixer sets, exposed

	637.20.107 Aufputz Wannenfüll- und Brausebatterie 1/2", mit Garnitur <ul style="list-style-type: none"> mit Hebelgriff Ausladung 224 mm Metall-Handbrause mit Anti-Kalk-System und Rückflussverhinderer Metall-Brauseschlauch 1500 mm 	Exposed tub/shower mixer 1/2", incl. shower set <ul style="list-style-type: none"> with lever handle spout projection 224 mm metal hand shower with anticalc. system and backflow preventer metal shower hose 1500 mm 	A	B	C	D	E	
				1.389,-	1.794,-	1.878,-	1.958,-	2.315,-
				G	H	I	K	L
				1.809,-	2.289,-	2.928,-	3.221,-	3.499,-

Griffvariante | Handle alternative

	637.20.102 Aufputz Wannenfüll- und Brausebatterie 1/2", mit Garnitur <ul style="list-style-type: none"> mit Kreuzgriff 	Exposed tub/shower mixer 1/2", incl. shower set <ul style="list-style-type: none"> with cross handle 					

	637.20.147 Wannenfüll- und Brausebatterie für Standrohrmontage, mit Garnitur <ul style="list-style-type: none"> mit Hebelgriff Ausladung mit Standrohren 256 mm Metall-Handbrause und -Brauseschlauch 	Tub/shower mixer for supply pipes, incl. shower set <ul style="list-style-type: none"> with lever handle spout projection with pipes 256 mm metal hand shower and shower hose 	A	B	C	D	E	
				1.187,-	1.489,-	1.544,-	1.639,-	1.866,-
				G	H	I	K	L
				1.625,-	2.089,-	2.738,-	3.012,-	3.339,-

Griffvariante | Handle alternative

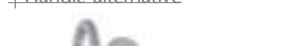
	637.20.142 Wannenfüll- und Brausebatterie für Standrohrmontage, mit Garnitur <ul style="list-style-type: none"> mit Kreuzgriff 	Tub/shower mixer for supply pipes, incl. shower set <ul style="list-style-type: none"> with cross handle 					

Benötigt | Required

	600.15.260 Wasserzufuhrstandrohre 1/2" <ul style="list-style-type: none"> 2 Stück, in Boden einzuschrauben inkl. Winkelstück zum Anschluß der Wannenfüll- und Brausebatterie Höhe 775 - 800 mm für 637.20.145 und 637.20.140 	Water supply pipes 1/2" <ul style="list-style-type: none"> 2 pieces, floor installation incl. angle for connecting tub/shower mixer height 775 - 800 mm for 637.20.145 and 637.20.140 	A	B	C	D	E	
				935,-	1.484,-	1.718,-	1.944,-	2.280,-
				G	H	I	K	L
				1.718,-	2.056,-	2.449,-	2.694,-	3.385,-

Empfohlen | Recommended

	109.10.970 Bausatz-Vormontage <ul style="list-style-type: none"> Bodenplatte mit Befestigungsset für Wasserzufuhrstandrohre 600.15.260 	Assembly set for pre-installation <ul style="list-style-type: none"> joint plate with fixing set for water supply pipes 600.15.260 	A				
				459,-			

CRONOS

Maßzeichnungen unter www.joerger.de - Menü SERVICE.
 Technical specifications under www.joerger.de - menu SERVICE.

A chrom chrome	[.000]	E platin matt platinum matt	[.066]
B silbernickel polished nickel	[.035]	G schwarz-matt black matt	[.092]
C nerz mink	[.095]	G weiß-matt white matt	[.052]
C nickel matt satin nickel	[.036]	H bronze bronze	[.011]
D edelmessing sunshine	[.040]	I gold gold	[.020]
D platin platinum	[.065]	K alt-gold antique-gold	[.025]
E edelmess.matt sunshine matt	[.041]	L roségold rosegold	[.022]
E gold matt gold matt	[.021]	L roségold matt rosegold matt	[.023]

	637.11.100 Wand-Wanneneinlauf ¾" <ul style="list-style-type: none"> ■ Ausladung 215 - 225 mm ■ Steckanschluß-Montage 	Tub wall spout ¾" <ul style="list-style-type: none"> ■ spout projection 215 - 225 mm ■ special concealed wall attachment 	A	B	C	D	E	
				556,-	684,-	754,-	852,-	998,-
				G	H	I	K	L
				749,-	963,-	1.152,-	1.268,-	1.728,-

Dusche, Aufputz-Batterien | Shower mixer sets, exposed

	637.20.205 Brausebatterie ½" für Aufputzmontage <ul style="list-style-type: none"> ■ mit Hebelgriffen ■ 2 keramische Oberteile ½" ■ Brauseabgang ½" ■ verdeckte S-Anschlüsse ½" x ¾" 	Exposed shower mixer ½" <ul style="list-style-type: none"> ■ with lever handles ■ 2 ceramic internal upper parts ½" ■ discharge ½" ■ concealed S-connections ½" x ¾" 	A	B	C	D	E	
				699,-	747,-	849,-	889,-	1.042,-
				G	H	I	K	L
				1.084,-	1.332,-	1.209,-	1.330,-	2.359,-

Griffvariante | Handle alternative

	637.20.200 Brausebatterie ½" für Aufputzmontage <ul style="list-style-type: none"> ■ mit Kreuzgriffen 	Exposed shower mixer ½" <ul style="list-style-type: none"> ■ with cross handles 	A	B	C	D	E	

	637.20.255 Brausethermostat ½" für Aufputzmontage <ul style="list-style-type: none"> ■ mit Hebelgriff ■ Dehnstoff-Thermoelement ■ Sicherheitssperre bei 38° C ■ Keramik-Innenoberteil ½" 	Exposed shower thermostat ½" <ul style="list-style-type: none"> ■ with lever handle ■ cartridge with thermoelement ■ locking device at 38 °C ■ ceramic cartridge ½" 	A	B	C	D	E	
				998,-	1.138,-	1.260,-	1.390,-	1.570,-
				G	H	I	K	L
				1.346,-	1.659,-	2.090,-	2.299,-	3.204,-

Griffvariante | Handle alternative

	637.20.250 Brausethermostat ½" für Aufputzmontage <ul style="list-style-type: none"> ■ mit Kreuzgriff 	Exposed shower thermostat ½" <ul style="list-style-type: none"> ■ with cross handle 	A	B	C	D	E	

637.20.41x – Aufputz Set mit Steigrohr | Exposed set with shower system

	649.13.920 Regenbrause ½", ø 200 mm <ul style="list-style-type: none"> ■ Ausführung ganz in Metall ■ mit Kugelgelenk ■ Anti-Kalk-System 	Rain shower head ½", ø 200 mm <ul style="list-style-type: none"> ■ full metal body ■ with ball joint ■ with anticalcareous system 	A	B	C	D	E	
				260,-	619,-	824,-	895,-	1.268,-
				G	H	I	K	L
				821,-	1.098,-	1.389,-	1.528,-	2.189,-

	649.20.281 Steigrohr, Umstellung, Wandarm <ul style="list-style-type: none"> ■ zum Anschluß an die Brausebatterie ■ in der Neigung und Höhe verstellbare Brausehalterung ■ Ausladung 360 - 380 mm 	Supply pipe, diverter, wall bracket <ul style="list-style-type: none"> ■ to connect the exposed shower mixer ■ fitting for handshower adjustable in height and inclination ■ projection 360 - 380 mm 	A	B	C	D	E	
				568,-	925,-	1.161,-	1.235,-	1.710,-
				G	H	I	K	L
				1.314,-	1.649,-	1.957,-	2.153,-	2.796,-

	632.13.705 Brausegarnitur <ul style="list-style-type: none"> ■ Metall-Handbrause mit Anti-Kalk-System und Rückflussverhinderer ■ Metall-Brauseschlauch 1500 mm, beidseitig mit drehbarem Konus 	Shower combination <ul style="list-style-type: none"> ■ metal hand shower with anticalc. system and backflow preventer ■ metal shower hose 1500 mm, both sides with turning cone 	A	B	C	D	E	
				279,-	499,-	546,-	648,-	796,-
				G	H	I	K	L
				598,-	896,-	1.138,-	1.252,-	1.379,-

Griffvariante | Handle alternative

	637.20.215 Aufputz-Brausebatterie ½" <ul style="list-style-type: none"> ■ mit Hebelgriffen ■ für Steigrohr, Brauseabgang ¾" 	Exposed shower mixer ½" <ul style="list-style-type: none"> ■ with lever handles ■ for supply pipe, discharge ¾" 	A	B	C	D	E	
				576,-	747,-	849,-	889,-	1.042,-
				G	H	I	K	L
				1.084,-	1.332,-	1.209,-	1.330,-	2.359,-

Griffvariante | Handle alternative

	637.20.210 Aufputz-Brausebatterie ½" <ul style="list-style-type: none"> ■ mit Kreuzgriffen 	Exposed shower mixer ½" <ul style="list-style-type: none"> ■ with cross handles 	A	B	C	D	E	

CRONOS

Maßzeichnungen unter www.joerger.de - Menü SERVICE.
 Technical specifications under www.joerger.de - menu SERVICE.

A chrom chrome	[.000]	E platin matt platinum matt	[.066]
B silbernickel polished nickel	[.035]	G schwarz-matt black matt	[.092]
C nerz milk	[.095]	G weiß-matt white matt	[.052]
C nickel matt satin nickel	[.036]	H bronze bronze	[.011]
D edelmessing sunshine	[.040]	I gold gold	[.020]
D platin platinum	[.065]	K alt-gold antique-gold	[.025]
E edelmess.matt sunshine matt	[.041]	L roségold rosegold	[.022]
E gold matt gold matt	[.021]	L roségold matt rosegold matt	[.023]

637.20.46x – Aufputz Set mit Steigrohr | Exposed set with shower system



Griffvariante
| Handle alternative



649.13.920 Regenbrause ½", ø 200 mm ■ Ausführung ganz in Metall ■ mit Kugelgelenk ■ Anti-Kalk-System	Rain shower head ½", ø 200 mm ■ full metal body ■ with ball joint ■ with anticalcareous system	A	B	C	D	E
		260,-	619,-	824,-	895,-	1.268,-
		G	H	I	K	L
		821,-	1.098,-	1.389,-	1.528,-	2.189,-
<hr/>						
649.20.281 Steigrohr, Umstellung, Wandarm ■ zum Anschluß an die Brausebatterie ■ in der Neigung und Höhe verstellbare Brausehalterung ■ Ausladung 360 - 380 mm	Supply pipe, diverter, wall bracket ■ to connect the exposed shower mixer ■ fitting for handshower adjustable in height and inclination ■ projection 360 - 380 mm	A	B	C	D	E
		568,-	925,-	1.161,-	1.235,-	1.710,-
		G	H	I	K	L
		1.314,-	1.649,-	1.957,-	2.153,-	2.796,-
<hr/>						
632.13.705 Brausegarnitur ■ Metall-Handbrause mit Anti-Kalk-System und Rückflussverhinderer ■ Metall-Brauseschlauch 1500 mm, beidseitig mit drehbarem Konus	Shower combination ■ metal hand shower with anticalc. system and backflow preventer ■ metal shower hose 1500 mm, both sides with turning cone	A	B	C	D	E
		279,-	499,-	546,-	648,-	796,-
		G	H	I	K	L
		598,-	896,-	1.138,-	1.252,-	1.379,-
<hr/>						
637.20.265 Aufputz-Brausethermostat ½" ■ mit Hebelgriff ■ für Steigrohr, Brauseabgang ¾"	Exposed shower thermostat ½" ■ with lever handle ■ for supply pipe, discharge ¾"	A	B	C	D	E
		886,-	1.039,-	1.175,-	1.216,-	1.468,-
		G	H	I	K	L
		1.328,-	1.619,-	1.986,-	2.185,-	3.048,-
<hr/>						
637.20.260 Aufputz-Brausethermostat ½" ■ mit Kreuzgriff	Exposed shower thermostat ½" ■ with cross handle	A	B	C	D	E
		886,-	1.039,-	1.175,-	1.216,-	1.468,-
		G	H	I	K	L
		1.328,-	1.619,-	1.986,-	2.185,-	3.048,-

Unterputz-Thermostate ½" | Wall thermostats, concealed ½"



637.40.380 Unterputz-Thermostat ½" mit Mengenregulierung, Fertigmontageset ■ manuelle, keramische Umstellung Wanne/Brause, druckunabhängig ■ mit Sicherheitseinrichtung ■ Durchflussrate 20,4 l/min bei 3 bar	Concealed wall thermostat ½" with flow control, assembly set ■ manual, ceramic diverter tub/shower for pressure-independent function ■ with safety device ■ flow rate 20,4 l/min at 3 bar	A	B	C	D	E
		1.225,-	1.399,-	1.519,-	1.560,-	1.859,-
		G	H	I	K	L
		1.492,-	1.764,-	2.157,-	2.373,-	2.595,-

Variante | Alternative



637.40.360 Unterputz-Thermostat ½" mit Mengenregulierung, Fertigmontageset ■ ohne Umstellung ■ mit integrierter keramischer Mengenregulierung ■ Durchflussrate 20,4 l/min bei 3 bar	Concealed wall thermostat ½" with flow control, assembly set ■ without diverter ■ with integrated ceramic cartridge for volume control ■ flow rate 20,4 l/min at 3 bar	A	B	C	D	E
		1.212,-	1.354,-	1.485,-	1.525,-	1.823,-
		G	H	I	K	L
		1.484,-	1.754,-	2.122,-	2.335,-	2.529,-

Variante | Alternative



637.40.460 Unterputz-Thermostat ½" ohne Mengenregulierung, Fertigmontageset ■ Funktionseinheit ohne Umstellung und ohne Absperrung ■ Durchflussrate 25,8 l/min bei 3 bar	Concealed wall thermostat ½" without flow control, assembly set ■ Functional unit without diverter and without shut-off ■ flow rate 25,8 l/min at 3 bar	A	B	C	D	E
		884,-	1.038,-	1.220,-	1.279,-	1.539,-
		G	H	I	K	L
		1.196,-	1.462,-	1.710,-	1.881,-	2.018,-

Benötigt | Required



649.40.360 Unterputz-Einbaubox ½" ■ zu Fertigmontageset 637.40.360, 637.40.380 und 637.40.460 ■ für Nass- und Trockenbau geeignet	Concealed wall box ½" ■ for assembly set 637.40.360, 637.40.380 and 637.40.460 ■ for wetwall and drywall construction	A				
		168,-				

Maßzeichnungen unter www.joerger.de - Menü SERVICE.
 Technical specifications under www.joerger.de - menu SERVICE.

A chrom chrome	[.000]	E platin matt platinum matt	[.066]
B silbernickel polished nickel	[.035]	G schwarz-matt black matt	[.092]
C nerz milk	[.095]	G weiß-matt white matt	[.052]
C nickel matt satin nickel	[.036]	H bronze bronze	[.011]
D edelmessing sunshine	[.040]	I gold gold	[.020]
D platin platinum	[.065]	K alt-gold antique-gold	[.025]
E edelmess.matt sunshine matt	[.041]	L roségold rosegold	[.022]
E gold matt gold matt	[.021]	L roségold matt rosegold matt	[.023]

Unterputz-Thermostat ¾" mit hohem Durchfluß | Wall thermostat, concealed ¾" with high flow



637.40.560 Unterputz-Thermostat ¾" **ohne** Mengenregulierung, Fertigmontageset

- serienbezogener Temperiergriff
- Sicherheitsperre bei 38° C

Concealed wall thermostat ¾" **without** flow control, assembly set

- design handle for temp. control
- locking device at 38°C

A	B	C	D	E
524,-	619,-	961,-	1.009,-	1.306,-
G	H	I	K	L
961,-	1.228,-	1.497,-	1.647,-	1.934,-

Benötigt | Required



649.40.555 Unterputz-Einbaukörper ¾"

- zu Fertigmontageset 637.40.555
- Kartusche mit Schmutzfangsieben
- für Nass- und Trockenbau geeignet
- Durchflussrate 64,2 l/min bei 3 bar
- **ohne** Absperrung

Concealed thermostat body ¾"

- for assembly set 637.40.555
- cartridge with filter screens
- for wetwall and drywall construction
- flow rate 64,2 l/min at 3 bar
- **without** shut-off

A	B	C	D	E
1.636,-				

Unterputz-Thermostat ¾" | Wall thermostat, concealed ¾"



637.40.520 Unterputz-Thermostat ¾" **ohne** Mengenregulierung, Fertigmontageset

- serienbezogener Temperiergriff
- Sicherheitsperre bei 38° C

Concealed wall thermostat ¾" **without** flow control, assembly set

- design handle for temp. control
- locking device at 38°C

A	B	C	D	E
524,-	619,-	961,-	1.009,-	1.306,-
G	H	I	K	L
961,-	1.228,-	1.497,-	1.647,-	1.934,-

Benötigt | Required



649.40.520 Unterputz-Einbaukörper ¾"

- zu Fertigmontageset 637.40.520
- Kartusche mit Schmutzfangsieben
- für Nass- und Trockenbau geeignet
- Durchflussrate 41 l/min bei 3 bar
- **ohne** Absperrung

Concealed thermostat body ¾"

- for assembly set 637.40.520
- cartridge with filter screens
- for wetwall and drywall construction
- flow rate 41 l/min at 3 bar
- **without** shut-off

A	B	C	D	E
498,-				

Unterputz-Ventile | Valves, concealed



637.50.235 Unterputz-Ventil Fertigmontageset

- mit Hebelgriff
- Griff
- Schubrosette, Hülse

Concealed wall valve assembly set

- with lever handle
- design handle
- socket with adjustable escutcheon

A	B	C	D	E
426,-	479,-	495,-	512,-	615,-
G	H	I	K	L
496,-	576,-	732,-	806,-	976,-

Griffvariante | Handle alternative



637.50.234 Unterputz-Ventil Fertigmontageset

- mit Kreuzgriff

Concealed wall valve assembly set

- with cross handle

Benötigt | Required



649.20.350 Unterputz-Ventil ½", Einbaukörper

- rechtsschließend, ker. Scheiben

Concealed wall valve ½", body

- clockwise closure, ceramic discs

A	B	C	D	E
66,-				



649.20.355 Unterputz-Ventil ½", Einbaukörper

- linksschließend, ker. Scheiben

Concealed wall valve ½", body

- counter-clockwise closure, cer. discs

A	B	C	D	E



649.20.450 Unterputz-Ventil ¾", Einbaukörper

- rechtsschließend, ker. Scheiben

Concealed wall valve ¾", body

- clockwise closure, ceramic discs

A	B	C	D	E
99,-				

649.20.455 Unterputz-Ventil ¾", Einbaukörper

- linksschließend, ker. Scheiben

Concealed wall valve ¾", body

- counter-clockwise closure, cer. discs

A	B	C	D	E

Maßzeichnungen unter www.joerger.de - Menü SERVICE.
 Technical specifications under www.joerger.de - menu SERVICE.

A chrom chrome	[.000]	E platin matt platinum matt	[.066]
B silbernickel polished nickel	[.035]	G schwarz-matt black matt	[.092]
C nerz milk	[.095]	G weiß-matt white matt	[.052]
C nickel matt satin nickel	[.036]	H bronze bronze	[.011]
D edelmessing sunshine	[.040]	I gold gold	[.020]
D platin platinum	[.065]	K alt-gold antique-gold	[.025]
E edelmess.matt sunshine matt	[.041]	L roségold rosegold	[.022]
E gold matt gold matt	[.021]	L roségold matt rosegold matt	[.023]

Unterputz-Thermostat/Ventil-Modul | Concealed thermostatic/wall-valve modul



637.60.435 Unterputz-Ventil-Modul
 Fertigmontageset

- mit Hebelgriff
- Rosette

Concealed wall-valve-modul
 assembly set

- with lever handle
- escutcheon

A	B	C	D	E
378,-	405,-	416,-	429,-	479,-
G	H	I	K	L
459,-	559,-	668,-	735,-	844,-

Griffvariante | Handle alternative



637.60.432 Unterputz-Ventil-Modul
 Fertigmontageset

- mit Kreuzgriff

Concealed wall-valve-modul
 assembly set

- with cross handle

Benötigt | Required



649.20.610 Unterputz-Ventil-Modul, 1-fach

- 1x Spindelventil 3/4", rechtsschließend mit keram. Scheiben
- 2 Abgänge 1/2", je 1x rechts/links möglich, gleichzeitig benutzbar

Concealed wall-valve-modul, single

- 1x spindle valve 3/4", clockwise closure with ceramic discs
- 2 outlets 1/2", each 1x right/left possible, simultaneously usable

A	B	C	D	E
229,-				



649.20.620 Unterputz-Ventil-Modul, 2-fach

- 2x Spindelventil 3/4", rechtsschließend mit keram. Scheiben
- 4 Abgänge 1/2", je 2x rechts/links möglich, gleichzeitig benutzbar
- im Verbund maßgenaue Montage
- erweiterbar mit 649.20.610

Concealed wall-valve-modul, double

- 2x spindle valve 3/4", clockwise closure with ceramic discs
- 4 outlets 1/2", each 2x right/left possible, simultaneously usable
- precise assembly due to composite
- expandable with 649.20.610

A	B	C	D	E
458,-				



649.20.630 Unterputz-Ventil-Modul, 3-fach

- 3x Spindelventil 3/4", rechtsschließend mit keram. Scheiben
- 6 Abgänge 1/2", je 3x rechts/links möglich, gleichzeitig benutzbar
- im Verbund maßgenauen Montage
- erweiterbar mit 649.20.610

Concealed wall-valve-modul, triple

- 3x spindle valve 3/4", clockwise closure with ceramic discs
- 6 outlets 1/2", each 3x right/left possible, simultaneously usable
- precise assembly due to composite
- expandable with 649.20.610

A	B	C	D	E
686,-				



637.40.460 Unterputz-Thermostat 1/2"
ohne Mengenregulierung,
 Fertigmontageset

- Funktionseinheit ohne Umstellung und ohne Absperrung
- Durchflußrate 25,8 l/min bei 3 bar

Concealed wall thermostat 1/2"
without flow control,
 assembly set

- Functional unit without diverter and without shut-off
- flow rate 25,8 l/min at 3 bar

A	B	C	D	E
884,-	1.038,-	1.220,-	1.279,-	1.539,-
G	H	I	K	L
1.196,-	1.462,-	1.710,-	1.881,-	2.018,-

Benötigt | Required



649.20.612 Anschlußadapter 1/2"

- Anschlußadapter, Abschlußstopfen
- passend zu Einbaubox 649.40.360

Connection adapter 1/2"

- connection adapter, end plug
- matching to wall box 649.40.360

A	B	C	D	E
122,-				



649.40.360 Unterputz-Einbaubox 1/2"

- zu Fertigmontageset 637.40.460
- für Nass- und Trockenbau geeignet

Concealed wall box 1/2"

- for assembly set 637.40.460
- for wetwall and drywall construction

A	B	C	D	E
168,-				

CRONOS

Maßzeichnungen unter www.joerger.de - Menü SERVICE.
 Technical specifications under www.joerger.de - menu SERVICE.

A chrom chrome	[.000]	E platin matt platinum matt	[.066]
B silbernickel polished nickel	[.035]	G schwarz-matt black matt	[.092]
C nerz mink	[.095]	G weiß-matt white matt	[.052]
C nickel matt satin nickel	[.036]	H bronze bronze	[.011]
D edelmessing sunshine	[.040]	I gold gold	[.020]
D platin platinum	[.065]	K alt-gold antique-gold	[.025]
E edelmess.matt sunshine matt	[.041]	L roségold rosegold	[.022]
E gold matt gold matt	[.021]	L roségold matt rosegold matt	[.023]



637.40.560 Unterputz-Thermostat ¾" ohne Mengenregulierung, Fertigmontageset

- serienbezogener Temperiergriff
- Sicherheitssperre bei 38° C

Concealed wall thermostat ¾" without flow control, assembly set

- design handle for temp. control
- locking device at 38° C

A	B	C	D	E
524,-	619,-	961,-	1.009,-	1.306,-
G	H	I	K	L
961,-	1.228,-	1.497,-	1.647,-	1.934,-

Benötigt | Required



649.20.634 Anschlußadapter ¾"

- Anschlußadapter, Abschlußstopfen
- passend zu Einbaukörper 649.40.555

Connection adapter ¾"

- connection adapter, end plug
- matching to wall body 649.40.555

A	B	C	D	E
146,-				



649.40.555 Unterputz-Einbaukörper ¾"

- zu Fertigmontageset 637.40.555
- Kartusche mit Schmutzfangsieben
- für Nass- und Trockenbau geeignet
- Durchflussrate 64,2 l/min bei 3 bar
- ohne Absperrung

Concealed thermostat body ¾"

- for assembly set 637.40.555
- cartridge with filter screens
- for wetwall and drywall construction
- flow rate 64,2 l/min at 3 bar
- without shut-off

A	B	C	D	E
1.636,-				

Unterputz-Umstellung | Diverter, concealed



637.40.655 Unterputz 3-Wege Umstellung Fertigmontageset

- mit Hebelgriff
- Rosette

Concealed 3-position diverter assembly set

- with lever handle
- escutcheon

A	B	C	D	E
426,-	479,-	495,-	512,-	615,-
G	H	I	K	L
496,-	576,-	732,-	806,-	976,-

Griffvariante | Handle alternative



637.40.650 Unterputz 3-Wege Umstellung Fertigmontageset

- mit Kreuzgriff

Concealed 3-position diverter assembly set

- with cross handle

Benötigt | Required



649.40.600 Unterputz 3-Wege Umstellung Einbaukörper ½"

- zu Fertigmontageset 637.40.650 and 637.40.655

Concealed 3-position diverter diverter body ½"

- for assembly set 637.40.650 and 637.40.655

A	B	C	D	E
236,-				

Brausen | Showers



637.13.302 Duschgarnitur, komplett

- Wandrohr 780 mm, mit Schieber
- Metall-Handbrause mit Anti-Kalk-System und Rückflussverhinderer
- Metall-Brauseschlauch 1750 mm, beidseitig mit drehbarem Konus

Shower bar set, complete

- wall bar 780 mm, with slider
- metal hand shower with anticalc. system and backflow preventer
- metal shower hose 1750 mm, both sides with turning cone

A	B	C	D	E
998,-	1.462,-	1.568,-	1.764,-	2.029,-
G	H	I	K	L
1.638,-	2.078,-	2.284,-	2.513,-	3.246,-

637.13.350 Duschstange, lose

- Wandrohr 780 mm, mit Schieber

Shower bar, separate

- wall bar 780 mm, with slider

A	B	C	D	E
808,-	1.032,-	1.129,-	1.274,-	1.464,-
G	H	I	K	L
1.204,-	1.374,-	1.692,-	1.862,-	2.149,-



637.13.202 Schlauchbrausegarnitur

- Wandanschlußbogen ½", Schubrosette, Wand-Brausehalter
- Metall-Handbrause mit Anti-Kalk-System und Rückflussverhinderer
- Metall-Brauseschlauch 1500 mm

Shower combination

- wall elbow connection ½"
- wall fitting for hand shower
- metal hand shower with anticalc. system and backflow preventer
- flexible metal shower hose 1500 mm

A	B	C	D	E
509,-	738,-	798,-	887,-	1.046,-
G	H	I	K	L
884,-	1.286,-	1.166,-	1.283,-	1.819,-

CRONOS

Maßzeichnungen unter www.joerger.de - Menü SERVICE.
 Technical specifications under www.joerger.de - menu SERVICE.

A chrom chrome	[.000]	E platin matt platinum matt	[.066]
B silbernickel polished nickel	[.035]	G schwarz-matt black matt	[.092]
C nerz milk	[.095]	G weiß-matt white matt	[.052]
C nickel matt satin nickel	[.036]	H bronze bronze	[.011]
D edelmessing sunshine	[.040]	I gold gold	[.020]
D platin platinum	[.065]	K alt-gold antique-gold	[.025]
E edelmess.matt sunshine matt	[.041]	L roségold rosegold	[.022]
E gold matt gold matt	[.021]	L roségold matt rosegold matt	[.023]

	637.13.150 Wandanschlußbogen 1/2", ohne Haken <ul style="list-style-type: none"> ■ Brauseabgang 1/2" ■ mit Rückflussverhinderer, Rosette 	Wall elbow connection 1/2", without cradle <ul style="list-style-type: none"> ■ discharge 1/2" ■ with backflow preventer, escutcheon 	A	B	C	D	E
			136,-	144,-	155,-	174,-	206,-
			G	H	I	K	L
			186,-	224,-	237,-	261,-	339,-

	649.13.270 Wand-Brausehalter	Wall fitting for hand shower	A	B	C	D	E
			178,-	233,-	254,-	279,-	306,-
			G	H	I	K	L
			218,-	252,-	352,-	388,-	476,-

	637.13.237 Hygienebrausegarnitur <ul style="list-style-type: none"> ■ Wandbrausehalter und -anschlußbogen 1/2", Schubrossette ■ Hygienebrause, klassisch (649.13.338), komplett aus Metall ■ einstrahlig, Bedienung über Druckhebel ■ Metall-Brauseschlauch 1250 mm 	Ablution spray combination <ul style="list-style-type: none"> ■ wall fitting and elbow connection 1/2" ■ spray handshower, classical (649.13.338), completely metal ■ one jet, push-lever operation ■ flexible metal shower hose 1250 mm 	A	B	C	D	E
			321,-	383,-	624,-	654,-	872,-
			G	H	I	K	L
			699,-	1.028,-	1.113,-	1.225,-	1.559,-

	637.20.237 1-Hand Batterie 1/2" für Hygiene-Brause, Fertigmontageset <ul style="list-style-type: none"> ■ Rosette, Griff 	Concealed single lever 1/2" for ablution spray, assembly set <ul style="list-style-type: none"> ■ escutcheon, handle 	A	B	C	D	E
			319,-	469,-	529,-	595,-	699,-
			G	H	I	K	L
			446,-	532,-	814,-	896,-	939,-

Benötigt | Required

	649.20.237 Unterputz 1-Hand Batterie 1/2", Einbaukörper <ul style="list-style-type: none"> ■ Kartusche mit keramischen Scheiben ■ zu Fertigmontageset 637.20.237 	Single lever mixer 1/2", concealed body <ul style="list-style-type: none"> ■ cartridge with ceramic discs ■ for assembly set 637.20.237 	A	B	C	D	E
			125,-	169,-	208,-	229,-	268,-
			G	H	I	K	L
			224,-	258,-	329,-	362,-	396,-

	649.13.930 Regenbrause 1/2", ø 300 mm <ul style="list-style-type: none"> ■ Ausführung ganz in Metall ■ mit Kugelgelenk ■ Anti-Kalk-System ■ ohne Wandarm 	Rain shower head 1/2", ø 300 mm <ul style="list-style-type: none"> ■ full metal body ■ with ball joint ■ with anticalcareous system ■ without wall bracket 	A	B	C	D	E
			776,-	1.279,-	1.446,-	1.524,-	2.092,-
			G	H	I	K	L
			1.479,-	2.110,-	2.242,-	2.467,-	3.364,-

Empfohlen | Recommended

	637.13.625 Wandarm 1/2" <ul style="list-style-type: none"> ■ Ausladung 400 mm 	Wall bracket 1/2" <ul style="list-style-type: none"> ■ projection 400 mm 	A	B	C	D	E
			294,-	547,-	648,-	728,-	929,-
			G	H	I	K	L
			496,-	569,-	947,-	1.042,-	1.179,-

CRONOS

Maßzeichnungen unter www.joerger.de - Menü SERVICE.
 Technical specifications under www.joerger.de - menu SERVICE.

A chrom chrome	[.000]	E platin matt platinum matt	[.066]
B silbernickel polished nickel	[.035]	G schwarz-matt black matt	[.092]
C nerz milk	[.095]	G weiß-matt white matt	[.052]
C nickel matt satin nickel	[.036]	H bronze bronze	[.011]
D edelmessing sunshine	[.040]	I gold gold	[.020]
D platin platinum	[.065]	K alt-gold antique-gold	[.025]
E edelmess.matt sunshine matt	[.041]	L roségold rosegold	[.022]
E gold matt gold matt	[.021]	L roségold matt rosegold matt	[.023]



- 649.13.615 Stachelkopfbrause 1/2"**
- ø 230 mm, 75 Düsen
 - Ausführung ganz in Metall
 - Anti-Kalk-System
 - Brausekopf schwenkbar
 - ohne Wandarm
- weitere, zur Serie passende Kopfbrausen siehe Kapitel "Brausen"

- Body spray shower head 1/2"**
- ø 230 mm, 75 jets
 - full metal body
 - anticalcareous system
 - swivel shower head
 - without wall bracket
- for further shower heads matching this collection see chapter "showers"

A	B	C	D	E
969,-	1.232,-	1.359,-	1.416,-	1.659,-
G	H	I	K	L
1.399,-	1.718,-	2.262,-	2.489,-	2.739,-

Empfohlen | Recommended



- 649.13.625 Wandarm 1/2"**
- Ausladung 162 mm
- weitere, zur Serie passende Wandarme siehe Kapitel "Brausen"

- Wall bracket 1/2"**
- projection 162 mm
- for further wall brackets matching this collection see chapter "showers"

A	B	C	D	E
126,-	145,-	171,-	189,-	250,-
G	H	I	K	L
192,-	296,-	286,-	315,-	499,-



- 649.13.519 Seitenbrause 1/2"**
- Rosette ø 130 mm, Wandmontage
 - Brausekopf schwenkbar, 20°
 - Anti-Kalk-System
 - Ausführung Kunststoff
- weitere, zur Serie passende Seitenbrausen siehe Kapitel "Brausen"

- Body spray side shower 1/2"**
- escutcheon ø 130 mm, wall assembly
 - swivel shower head, 20°
 - anticalcareous system
 - plastic
- for further side showers matching this collection see chapter "showers"

A	B	C	D	E
167,-	326,-	385,-	399,-	542,-
G	H	I	K	L
376,-	472,-	634,-	698,-	949,-



- 649.13.395 Handbrause 1/2"**
- Anti-Kalk-System
 - 3 Strahlarten: Normal, Massage, Soft
 - Anschluß 1/2"
- weitere, zur Serie passende Handbrausen siehe Kapitel "Brausen"

- Hand shower 1/2"**
- anticalcareous system
 - with 3 jets: normal, hydromassage, soft
 - connection 1/2"
- for further hand showers matching this collection see chapter "showers"

A	B	C	D	E
165,-	239,-	299,-	349,-	509,-
G	H	I	L	
297,-	436,-	648,-	713,-	856,-



- 649.13.391 Handbrause 1/2"**
- Anti-Kalk-System
 - 3 Strahlarten: Normal, Massage, Soft
 - Anschluß 1/2"
- weitere, zur Serie passende Handbrausen siehe Kapitel "Brausen"







- Hand shower 1/2"**
- anticalcareous system
 - with 3 jets: normal, hydromassage, soft
 - connection 1/2"
- for further hand showers matching this collection see chapter "showers"

A	B	C	D	E
208,-	398,-	426,-	464,-	578,-
G	H	I	L	
394,-	586,-	718,-	790,-	956,-

Maßzeichnungen unter www.joerger.de - Menü SERVICE.
 Technical specifications under www.joerger.de - menu SERVICE.

A chrom chrome	[.000]	E platin matt platinum matt	[.066]
B silbernickel polished nickel	[.035]	G schwarz-matt black matt	[.092]
C nerz mink	[.095]	G weiß-matt white matt	[.052]
C nickel matt satin nickel	[.036]	H bronze bronze	[.011]
D edelmessing sunshine	[.040]	I gold gold	[.020]
D platin platinum	[.065]	K alt-gold antique-gold	[.025]
E edelmess.matt sunshine matt	[.041]	L roségold rosegold	[.022]
E gold matt gold matt	[.021]	L roségold matt rosegold matt	[.023]

Accessoires für Handtücher | Accessories for towels







		A	B	C	D	E
	637.00.002 Handtuchhalter, doppelt ■ Rohre schwenkbar, ca. 430 mm	Double towel bar ■ swivelling bars, approx. 430 mm				
		342,-	482,-	524,-	576,-	712,-
		G	H	I	K	L
		624,-	746,-	783,-	862,-	1.248,-
	637.00.047 Handtuchring ■ ø ca. 190 mm ■ geschlossene Ausführung	Towel ring ■ ø approx. 190 mm ■ closed version				
		279,-	366,-	426,-	458,-	607,-
		G	H	I	K	L
		415,-	490,-	676,-	744,-	848,-
	637.00.022 Handtuchhaken, doppelt	Double robe hanger				
		164,-	208,-	255,-	269,-	348,-
		G	H	I	K	L
		268,-	322,-	378,-	416,-	559,-
	637.00.040 Badetuchhalter ■ ca. 800 mm	Bath towel bar ■ approx. 800 mm				
		499,-	610,-	679,-	768,-	976,-
		G	H	I	K	L
		679,-	878,-	1.120,-	1.232,-	1.696,-
	637.00.030 Duschtürgriff ■ ca. 580 mm	Shower door handle ■ approx. 580 mm				
		855,-	1.039,-	1.205,-	1.319,-	1.646,-
		G	H	I	K	L
		1.229,-	1.525,-	1.886,-	2.075,-	2.769,-
	637.00.031 Wannengriff ■ ca. 370 mm	Tub handle ■ approx. 370 mm				
		439,-	519,-	579,-	652,-	792,-
		G	H	I	K	L
		579,-	734,-	942,-	1.037,-	1.376,-
	637.00.104 Gästehandtuchkorb, eckig ■ mit Ablage ■ Korbgröße 260 x 150 x 190 mm	Guest towel basket, angular ■ with shelf ■ basket size 260 x 150 x 190 mm				
		494,-	639,-	693,-	783,-	916,-
		G	H	I	K	L
		693,-	949,-	1.022,-	1.125,-	1.858,-

CRONOS

Maßzeichnungen unter www.joerger.de - Menü SERVICE.
 Technical specifications under www.joerger.de - menu SERVICE.

A chrom chrome	[.000]	E platin matt platinum matt	[.066]
B silbernickel polished nickel	[.035]	G schwarz-matt black matt	[.092]
C nerz milk	[.095]	G weiß-matt white matt	[.052]
C nickel matt satin nickel	[.036]	H bronze bronze	[.011]
D edelmessing sunshine	[.040]	I gold gold	[.020]
D platin platinum	[.065]	K alt-gold antique-gold	[.025]
E edelmess.matt sunshine matt	[.041]	L roségold rosegold	[.022]
E gold matt gold matt	[.021]	L roségold matt rosegold matt	[.023]

Accessoires für Waschplatz | Accessories for washstands

	637.00.007 Seifenhalter, komplett ■ Seifenschale aus Kristallglas, seidenmatt	Soap dish holder, complete ■ crystal glass dish, frosted	A	B	C	D	E
			234,-	279,-	305,-	334,-	362,-
			G	H	I	K	L
			296,-	354,-	442,-	487,-	552,-
	737.00.307 Seifenschale, lose	Glass dish, separate	A				
			90,-				
	631.00.017 Seifenhalter, komplett ■ Standmodell ■ Seifenschale aus Kristallglas	Soap dish holder, complete ■ free standing version ■ crystal glass dish	A	B	C	D	E
			159,-	189,-	205,-	237,-	279,-
			G	H	I	K	L
			236,-	295,-	307,-	338,-	480,-
	637.00.105 Schwammkorb ■ rechteckig, 260 x 130 mm	Sponge basket ■ rectangular, 260 x 130 mm	A	B	C	D	E
			388,-	497,-	544,-	615,-	719,-
			G	H	I	K	L
			519,-	709,-	799,-	879,-	1.219,-
	637.00.106 Eckschwammkorb ■ 195 x 195 mm	Corner sponge basket ■ 195 x 195 mm	A	B	C	D	E
			417,-	518,-	566,-	640,-	748,-
			G	H	I	K	L
			534,-	734,-	838,-	922,-	1.199,-
	637.00.006 Lotionsspender, komplett ■ Glas aus Kristallglas, seidenmatt	Soap dispenser, complete ■ crystal glass, frosted	A	B	C	D	E
			299,-	326,-	355,-	398,-	426,-
			G	H	I	K	L
			340,-	429,-	497,-	547,-	759,-
	737.00.306 Lotionsspenderglas, lose ■ seidenmatt, ohne Pumpe	Soap dispenser glass, separate ■ frosted, without pump	A				
			96,-				
	631.00.016 Lotionsspender, komplett ■ Standmodell ■ Glas aus Kristallglas, seidenmatt	Soap dispenser, complete ■ free standing version ■ crystal glass, frosted	A	B	C	D	E
			189,-	224,-	242,-	277,-	323,-
			G	H	I	K	L
			295,-	378,-	448,-	493,-	718,-

CRONOS

Maßzeichnungen unter www.joerger.de - Menü SERVICE.
 Technical specifications under www.joerger.de - menu SERVICE.

A chrom chrome	[.000]	E platin matt platinum matt	[.066]
B silbernickel polished nickel	[.035]	G schwarz-matt black matt	[.092]
C nerz mink	[.095]	G weiß-matt white matt	[.052]
C nickel matt satin nickel	[.036]	H bronze bronze	[.011]
D edelmessing sunshine	[.040]	I gold gold	[.020]
D platin platinum	[.065]	K alt-gold antique-gold	[.025]
E edelmess.matt sunshine matt	[.041]	L roségold rosegold	[.022]
E gold matt gold matt	[.021]	L roségold matt rosegold matt	[.023]



637.00.036 Glashalter, komplett
 ■ Glas aus Kristallglas, seidenmatt

Tumbler holder, complete
 ■ crystal glass tumbler, frosted

A	B	C	D	E
246,-	284,-	308,-	339,-	367,-
G	H	I	K	L
298,-	357,-	445,-	490,-	557,-

737.00.336 Mundglas, lose

Glass tumbler, separate

A	B	C	D	E
92,-				



631.00.046 Glashalter, komplett
 ■ Standmodell
 ■ Glas aus Kristallglas, seidenmatt

Tumbler holder, complete
 ■ free standing version
 ■ crystal glass tumbler, frosted

A	B	C	D	E
169,-	199,-	215,-	247,-	289,-
G	H	I	K	L
246,-	305,-	317,-	349,-	490,-

Accessoires für WC-Bereich | Accessories for w.c. area



637.00.014 Papierhalter
 ■ mit Deckel

Toilet paper roll holder
 ■ with lid

A	B	C	D	E
257,-	312,-	349,-	392,-	472,-
G	H	I	K	L
418,-	629,-	676,-	744,-	1.096,-



637.00.015 Reserve-Papierhalter

Spare toilet paper roll holder

A	B	C	D	E
239,-	296,-	332,-	369,-	447,-
G	H	I	K	L
397,-	597,-	647,-	712,-	1.035,-



631.00.001 Klosettbürstengarnitur, komplett
 ■ stehendes Modell
 ■ Bürstentopf aus Metall

Toilet brush holder set, complete
 ■ floor standing model
 ■ brush holder out of brass

A	B	C	D	E
292,-	335,-	354,-	399,-	556,-
G	H	I	K	L
444,-	684,-	924,-	1.017,-	1.289,-

CRONOS

Maßzeichnungen unter www.joerger.de - Menü SERVICE.
 Technical specifications under www.joerger.de - menu SERVICE.

A chrom chrome	[.000]	E platin matt platinum matt	[.066]
B silbernickel polished nickel	[.035]	G schwarz-matt black matt	[.092]
C nerz milk	[.095]	G weiß-matt white matt	[.052]
C nickel matt satin nickel	[.036]	H bronze bronze	[.011]
D edelmessing sunshine	[.040]	I gold gold	[.020]
D platin platinum	[.065]	K alt-gold antique-gold	[.025]
E edelmess.matt sunshine matt	[.041]	L roségold rosegold	[.022]
E gold matt gold matt	[.021]	L roségold matt rosegold matt	[.023]



637.00.000 Klosettbürstengarnitur, komplett ■ Glas aus Kristallglas, seidenmatt	Toilet brush holder set, complete ■ crystal glass, frosted	A	B	C	D	E
		382,-	439,-	464,-	490,-	552,-
		G	H	I	K	L
		447,-	592,-	760,-	836,-	942,-

799.00.301 Bürstenglas, seidenmatt, lose	Brush glass, frosted, separate	A				
		29,-				

687.00.053 Bürstenstange komplett, lose	Brush rod with brush, separate	A	B	C	D	E
		178,-	204,-	215,-	228,-	257,-
		G	H	I	K	L
		208,-	275,-	339,-	373,-	438,-

799.00.240 Bürstenkopf, lose	Brush, separate	A				
		19,-				

Leuchten und Spiegel | Lamps and mirrors



637.00.061 Wandleuchte, komplett ■ mit Leuchtmittel, 40 W	Wall lamp, complete ■ light bulb included, 40 W	A	B	C	D	E
		792,-	839,-	868,-	895,-	1.054,-
		G	H	I	K	L
		1.059,-	1.159,-	1.352,-	1.488,-	1.768,-

710.00.361 Leuchtenglas <u>gewolkt</u> , lose	<u>Clouded</u> glass, separate	A				
		216,-				



649.00.414 Kosmetikspiegel, beleuchtet ■ schwenk- und ausziehbar ■ 3-fache Vergrößerung ■ Direktanschluss ■ Spiegeldurchmesser 185 mm ■ Rahmendurchmesser 250 mm ■ Kalt-, Warm- und Taglicht durch Piezzo-Schalter umschaltbar	Cosmetic mirror, incl. lighting ■ swivelling and extendable ■ magnification 3:1 ■ direct connection ■ mirror diameter 185 mm ■ frame diameter 250 mm ■ cold, warm and day light switchable by Piezzo switch	A	B	C	D	E
		556,-	988,-	1.214,-	1.418,-	1.828,-
		G	H	I	K	L
		1.214,-	1.549,-	2.138,-	2.352,-	2.998,-



CRONOS CRYSTAL



Oberflächen | colours

Folgende Oberflächen sind bei dieser Serie möglich |
The following colours are possible with this collection

chrom		chrome	[.000]	PG A
silbernickel		polished nickel	[.035]	PG B
nerz		mink	[.095]	PG C
nickel matt		satin nickel	[.036]	PG C
edelmessing		sunshine	[.040]	PG D
platin		platinum	[.065]	PG D
edelmessing matt		sunshine matt	[.041]	PG E
gold matt		gold matt	[.021]	PG E
platin matt		platinum matt	[.066]	PG E
schwarz matt		black matt	[.092]	PG G
weiß matt		white matt	[.052]	PG G
bronze		bronze	[.011]	PG H
gold		gold	[.020]	PG I
alt-gold		antique-gold	[.025]	PG K
roségold		rosegold	[.022]	PG L
roségold matt		rosegold matt	[.023]	PG L

Andere Oberflächen auf Anfrage |
Different colours on request

Auf Anfrage können wir Produkte von Drittanbietern auch gerne passend zu unseren Oberflächen veredeln (vorbehaltlich der Eignungsprüfung) | Third-party products may be plated matching to our colours on request (subject to valuation of suitability)

Waschtisch | Washbasin

ab Seite | from page 200

Bidet | Bidet

ab Seite | from page 200

Wanne | Bath tub

ab Seite | from page 201

Dusche | Shower

ab Seite | from page 202

Accessoires | Accessories

ab Seite | from page 209

CRONOS CRYSTAL

Maßzeichnungen unter www.joerger.de - Menü SERVICE.
 Technical specifications under www.joerger.de - menu SERVICE.

A chrom chrome	[.000]	E platin matt platinum matt	[.066]
B silbernickel polished nickel	[.035]	G schwarz-matt black matt	[.092]
C nerz milk	[.095]	G weiß-matt white matt	[.052]
C nickel matt satin nickel	[.036]	H bronze bronze	[.011]
D edelmessing sunshine	[.040]	I gold gold	[.020]
D platin platinum	[.065]	K alt-gold antique-gold	[.025]
E edelmess.matt sunshine matt	[.041]	L roségold rosegold	[.022]
E gold matt gold matt	[.021]	L roségold matt rosegold matt	[.023]

-11 kristallklar | clear as crystal

Die Artikelnummer wird um weitere 2 Ziffern erweitert. Beispiel:
 Waschtisch 3-Loch Batterie in chrom mit Griffen in kristallklar:

637.30.300.000-11
 Modell Oberfläche Kristallgriff

The article number needs to be added by 2 additional figures. For example:
 washbasin 3-hole mixer in chrome with handles in clear as crystal:

637.30.300.000-11
 model surface crystal handle

Waschtisch Batterien | Washbasin mixer

	637.30.300 Waschtisch 3-Loch Batterie 1/2" <ul style="list-style-type: none"> ■ Ausladung 160 mm; Höhe 280 mm ■ 2 Seitenrandventile mit keramischen Oberteilen 1/2", rechts und links schließend ■ Ablaufventil mit Klickverschluß 1 1/4" ■ empfohlen: 2x 649.15.530 - Kupferrohr 300 mm 	Washbasin 3-hole mixer 1/2" <ul style="list-style-type: none"> ■ spout projection 180 mm; height 260 mm ■ 2 side valves with ceramic internal upper parts 1/2" ■ push-open waste 1 1/4" ■ recommended: 2x 649.15.530 - copper tube 300 mm 	A	B	C	D	E	
				1.199,-	1.434,-	1.576,-	1.774,-	2.088,-
				G	H	I	K	L
			1.732,-	1.994,-	2.574,-	2.832,-	3.465,-	

Wand-Waschtisch 3-Loch Batterie | Wall-Washbasin 3-hole mixer

	637.30.360 Wand-Waschtisch 3-Loch Batterie 1/2", Fertigmontageset <ul style="list-style-type: none"> ■ Wand-Auslauf, Ausladung 200 - 212 mm ■ Griff, Rosette ■ Oberteile 1/2", keramische Scheiben 	Wall washbasin 3-hole mixer 1/2" assembly set <ul style="list-style-type: none"> ■ wall spout, projection 200 - 212 mm ■ design handle, escutcheon ■ cartridges 1/2", with ceramic discs 	A	B	C	D	E	
				1.116,-	1.239,-	1.342,-	1.382,-	1.625,-
				G	H	I	K	L
			1.445,-	1.665,-	2.172,-	2.390,-	2.878,-	

Benötigt | Required

	649.30.380 Wand-Waschtisch 3-Loch Batterie 1/2", Einbaukörper <ul style="list-style-type: none"> ■ 2 Anschlüsse, Stichmaß 204 mm ■ zu Fertigmontageset 637.30.360 	Wall washbasin 3-hole mixer 1/2" concealed body <ul style="list-style-type: none"> ■ 2 connections, center distance 204 mm ■ for assembly set 637.30.360 	A					
				296,-				

Bidet Batterien | Bidet mixer

	637.10.100 Bidet 1-Loch Batterie 1/2" <ul style="list-style-type: none"> ■ Ausladung 125 mm; Höhe 162 mm ■ Exzenter-Ablaufgarnitur 1 1/4" ■ 2 Kupferrohre M10x1 x 400 mm 	Bidet 1-hole mixer 1/2" <ul style="list-style-type: none"> ■ spout projection 125 mm; height 162 mm ■ pop-up waste 1 1/4" ■ 2 copper tubes M10x1 x 400 mm 	A	B	C	D	E	
				1.153,-	1.299,-	1.364,-	1.498,-	1.822,-
				G	H	I	K	L
			1.464,-	1.659,-	2.245,-	2.470,-	2.846,-	

Zubehör für Waschtisch- und Bidet-Batterien | Supplies for washbasin and bidet mixer

	637.12.100 Eckventil 1/2" <ul style="list-style-type: none"> ■ Ausladung 138 mm ■ Fettkammer-Innenoberteil 1/2" ■ Quetschverschraubung 1/2" ■ Schubrosette 	Angle valve 1/2" <ul style="list-style-type: none"> ■ projection 138 mm ■ cartridge 1/2" ■ compression joint 1/2" ■ escutcheon 	A	B	C	D	E	
				324,-	377,-	399,-	437,-	586,-
				G	H	I	K	L
			445,-	599,-	696,-	766,-	848,-	

	649.15.530 Kupferrohr, 300 mm <ul style="list-style-type: none"> ■ mit Bördel, für Quetschverschraubung 	Copper tube, 300 mm <ul style="list-style-type: none"> ■ with flange, for compression joint 	A	B	C	D	E	
				15,-	38,-	55,-	62,-	74,-
				G	H	I	K	L
			75,-	94,-	112,-	124,-	169,-	

CRONOS CRYSTAL

Maßzeichnungen unter www.joerger.de - Menü SERVICE.
 Technical specifications under www.joerger.de - menu SERVICE.

A chrom chrome	[.000]	E platin matt platinum matt	[.066]
B silbernickel polished nickel	[.035]	G schwarz-matt black matt	[.092]
C nerz mink	[.095]	G weiß-matt white matt	[.052]
C nickel matt satin nickel	[.036]	H bronze bronze	[.011]
D edelmessing sunshine	[.040]	I gold gold	[.020]
D platin platinum	[.065]	K alt-gold antique-gold	[.025]
E edelmess.matt sunshine matt	[.041]	L roségold rosegold	[.022]
E gold matt gold matt	[.021]	L roségold matt rosegold matt	[.023]

-11 Kristallklar | clear as crystal

Die Artikelnummer wird um weitere 2 Ziffern erweitert. Beispiel:
 Waschtisch 3-Loch Batterie in chrom mit Griffen in kristallklar:

637.30.300.000-11
 Modell Oberfläche Kristallgriff

The article number needs to be added by 2 additional figures. For example:
 washbasin 3-hole mixer in chrome with handles in clear as crystal:

637.30.300.000-11
 model surface crystal handle

Variante | Alternative

649.15.550 Kupferrohr, 500 mm
 ■ mit Bördel, für Quetschverschraubung

Copper tube, 500 mm
 ■ with flange, for compression joint



A	B	C	D	E
20,-	58,-	77,-	87,-	102,-
G	H	I	K	L
77,-	96,-	134,-	148,-	219,-



649.15.340 Waschtisch-Tassensiphon 1 ¼"
 ■ schwere Ausführung
 ■ Rosette
 ■ Abgangsrohr ø 32 mm
 ■ Tauchrohrlänge 165 mm

Washbasin cupped siphon trap 1 ¼"
 ■ heavy brass
 ■ escutcheon
 ■ outlet tube ø 32 mm
 ■ dip pipe 165 mm

A	B	C	D	E
195,-	296,-	368,-	429,-	568,-
G	H	I	K	L
378,-	539,-	686,-	755,-	832,-



649.15.330 Bidet-Tassensiphon 1 ¼"
 ■ Rosette
 ■ Abgangsrohr ø 32 mm

Bidet cupped siphon trap 1 ¼"
 ■ escutcheon
 ■ outlet tube ø 32 mm

A	B	C	D	E
98,-	166,-	276,-	332,-	472,-
G	H	I	K	L
364,-	508,-	648,-	713,-	796,-

Badewanne, Stand-Batterien | Bath tub mixer sets, deck mount



637.40.102 4-Loch Wannenfüll- u. Brause-
 batterie ½", Standmontage
 ■ Ausladung 172 mm; Höhe 275 mm
 ■ 2 Seitenrandventile mit keramischen
 Oberteilen ½"
 ■ Metall-Brauseschlauch 2000 mm
 ■ Metall-Handbrause mit Anti-Kalk-
 System und Rückflussverhinderer

Tub/shower mixer set ½"
 deck mount
 ■ spout projection 172 mm;
 height 275 mm
 ■ 2 side valves, ceramic internal upper
 parts ½"
 ■ metal shower hose 2000 mm
 ■ metal hand shower with anticalc.
 system and backflow preventer

A	B	C	D	E
2.035,-	2.274,-	2.460,-	2.778,-	3.260,-
G	H	I	K	L
2.348,-	2.932,-	3.829,-	4.212,-	4.925,-

Variante | Alternative



637.40.152 4-Loch Wannenrandkombi ½"
 ■ für Ab- und Überlaufgarnitur mit
 Wanneneinlauf, ohne
 Rohrunterbrecher
 ■ Seitenrandventile, 2-Wege
 Umstellung
 ■ Metall-Brauseschlauch 2000 mm
 ■ Metall-Handbrause mit Anti-Kalk-
 System und Rückflussverhinderer
 ■ empfohlen:
 649.40.160 - Montageplatte

Tub/shower combination ½"
 ■ for waste and overflow set with bath
 tub filler spout, without pipe
 interrupter
 ■ side valves, 2-position diverter
 ■ metal shower hose 2000 mm
 ■ metal hand shower with anticalc.
 system and backflow preventer
 ■ recommended:
 649.40.160 - assembly plate

A	B	C	D	E
1.609,-	2.209,-	2.345,-	2.578,-	2.957,-
G	H	I	K	L
2.195,-	2.685,-	3.425,-	3.768,-	4.615,-

Empfohlen | Recommended



649.40.160 Montageplatte, komplett
 ■ für 4-Loch Armaturen
 ■ Druckschläuche ½" x ½" x 600 mm
 ■ empfohlen: Schlauchkastensystem
 siehe Kapitel "Serienübergreifendes"

Assembly plate, complete
 ■ for deck mounted tub/shower mixer
 ■ pressure hoses ½" x ½" x 600 mm
 ■ recommended: system with hose
 box see chapter "universal products"

A	B	C	D	E
308,-				

CRONOS CRYSTAL

Maßzeichnungen unter www.joerger.de - Menü SERVICE.
 Technical specifications under www.joerger.de - menu SERVICE.

A chrom chrome	[.000]	E platin matt platinum matt	[.066]
B silbernickel polished nickel	[.035]	G schwarz-matt black matt	[.092]
C nerz mink	[.095]	G weiß-matt white matt	[.052]
C nickel matt satin nickel	[.036]	H bronze bronze	[.011]
D edelmessing sunshine	[.040]	I gold gold	[.020]
D platin platinum	[.065]	K alt-gold antique-gold	[.025]
E edelmess.matt sunshine matt	[.041]	L roségold rosegold	[.022]
E gold matt gold matt	[.021]	L roségold matt rosegold matt	[.023]

-11 kristallklar | clear as crystal

Die Artikelnummer wird um weitere 2 Ziffern erweitert. Beispiel:
 Waschtisch 3-Loch Batterie in chrom mit Griffen in kristallklar:

637.30.300.000-11
 Modell Oberfläche Kristallgriff

The article number needs to be added by 2 additional figures. For example:
 washbasin 3-hole mixer in chrome with handles in clear as crystal:

637.30.300.000-11
 model surface crystal handle

Badewanne, Aufputz-Batterien | Bath tub mixer sets, exposed

	637.20.102	Aufputz Wannenfüll- und Brausebatterie 1/2", mit Garnitur <ul style="list-style-type: none"> ■ Ausladung 224 mm ■ Metall-Handbrause mit Anti-Kalk-System und Rückflussverhinderer ■ Metall-Brauseschlauch 1500 mm 	Exposed tub/shower mixer 1/2", incl. shower set <ul style="list-style-type: none"> ■ spout projection 224 mm ■ metal hand shower with anticalc. system and backflow preventer ■ metal shower hose 1500 mm 	A	B	C	D	E
				1.389,-	1.794,-	1.878,-	1.958,-	2.315,-
				G	H	I	K	L
				1.809,-	2.289,-	2.928,-	3.221,-	3.499,-

	637.20.142	Wannenfüll- und Brausebatterie für Standrohrmontage, mit Garnitur <ul style="list-style-type: none"> ■ Ausladung mit Standrohren 256 mm ■ Metall-Handbrause und -Brauseschlauch 	Tub/shower mixer for supply pipes, incl. shower set <ul style="list-style-type: none"> ■ spout projection with pipes 256 mm ■ metal hand shower and shower hose 	A	B	C	D	E
				1.187,-	1.489,-	1.544,-	1.639,-	1.866,-
				G	H	I	K	L
				1.625,-	2.089,-	2.738,-	3.012,-	3.339,-

Benötigt | Required

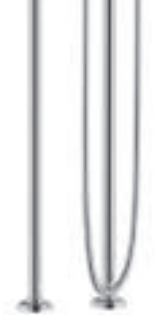
	600.15.260	Wasserzufuhrstandrohre 1/2" <ul style="list-style-type: none"> ■ 2 Stück, in Boden einzuschrauben ■ inkl. Winkelstück zum Anschluß der Wannenfüll- und Brausebatterie ■ Höhe 775 - 800 mm ■ für 637.20.145 und 637.20.140 	Water supply pipes 1/2" <ul style="list-style-type: none"> ■ 2 pieces, floor installation ■ incl. angle for connecting tub/shower mixer ■ height 775 - 800 mm ■ for 637.20.145 and 637.20.140 	A	B	C	D	E
				935,-	1.484,-	1.718,-	1.944,-	2.280,-
				G	H	I	K	L
				1.718,-	2.056,-	2.449,-	2.694,-	3.385,-

Empfohlen | Recommended

	109.10.970	Bausatz-Vormontage <ul style="list-style-type: none"> ■ Bodenplatte mit Befestigungsset ■ für Wasserzufuhrstandrohre 600.15.260 	Assembly set for pre-installation <ul style="list-style-type: none"> ■ joint plate with fixing set ■ for water supply pipes 600.15.260 	A				
				459,-				

Badewanne, Aufputz-Batterien | Bath tub mixer sets, exposed

	637.11.100	Wand-Wanneneinlauf 3/4" <ul style="list-style-type: none"> ■ Ausladung 215 - 225 mm ■ Steckanschluß-Montage 	Tub wall spout 3/4" <ul style="list-style-type: none"> ■ spout projection 215 - 225 mm ■ special concealed wall attachment 	A	B	C	D	E
				556,-	684,-	754,-	852,-	998,-
				G	H	I	K	L
				749,-	963,-	1.152,-	1.268,-	1.728,-

	637.20.200	Brausebatterie 1/2" für Aufputzmontage <ul style="list-style-type: none"> ■ 2 keramische Oberteile 1/2" ■ Brauseabgang 1/2" ■ verdeckte S-Anschlüsse 1/2" x 3/4" 	Exposed shower mixer 1/2" <ul style="list-style-type: none"> ■ 2 ceramic internal upper parts 1/2" ■ discharge 1/2" ■ concealed S-connections 1/2" x 3/4" 	A	B	C	D	E
				699,-	747,-	849,-	930,-	1.075,-
				G	H	I	K	L
				1.084,-	1.332,-	1.215,-	1.337,-	2.359,-

	637.20.250	Brausethermostat 1/2" für Aufputzmontage <ul style="list-style-type: none"> ■ Dehnstoff-Thermoelement ■ Sicherheitssperre bei 38° C ■ Keramik-Innenoberteil 1/2" 	Exposed shower thermostat 1/2" <ul style="list-style-type: none"> ■ cartridge with thermoelement ■ locking device at 38 °C ■ ceramic cartridge 1/2" 	A	B	C	D	E
				1.152,-	1.565,-	1.736,-	1.861,-	2.516,-
				G	H	I	K	L
				1.830,-	2.256,-	2.821,-	3.104,-	3.321,-

CRONOS CRYSTAL

Maßzeichnungen unter www.joerger.de - Menü SERVICE.
 Technical specifications under www.joerger.de - menu SERVICE.

A chrom chrome	[.000]	E platin matt platinum matt	[.066]
B silbernickel polished nickel	[.035]	G schwarz-matt black matt	[.092]
C nerz milk	[.095]	G weiß-matt white matt	[.052]
C nickel matt satin nickel	[.036]	H bronze bronze	[.011]
D edelmessing sunshine	[.040]	I gold gold	[.020]
D platin platinum	[.065]	K alt-gold antique-gold	[.025]
E edelmess.matt sunshine matt	[.041]	L roségold rosegold	[.022]
E gold matt gold matt	[.021]	L roségold matt rosegold matt	[.023]

-11 kristallklar | clear as crystal

Die Artikelnummer wird um weitere 2 Ziffern erweitert. Beispiel:
 Waschtisch 3-Loch Batterie in chrom mit Griffen in kristallklar:

637.30.300.000-11
 Modell Oberfläche Kristallgriff

The article number needs to be added by 2 additional figures. For example:
 washbasin 3-hole mixer in chrome with handles in clear as crystal:

637.30.300.000-11
 model surface crystal handle

637.20.410 – Set mit Steigrohr (bestehend aus:) | set with shower system (consisting of:)

	649.13.920 Regenbrause ½", ø 200 mm <ul style="list-style-type: none"> ■ Ausführung ganz in Metall ■ mit Kugelgelenk ■ Anti-Kalk-System 	Rain shower head ½", ø 200 mm <ul style="list-style-type: none"> ■ full metal body ■ with ball joint ■ with anticalcareous system 	A	B	C	D	E
			260,-	619,-	824,-	895,-	1.268,-
			G	H	I	K	L
			821,-	1.098,-	1.389,-	1.528,-	2.189,-
	649.20.281 Steigrohr, Umstellung, Wandarm <ul style="list-style-type: none"> ■ zum Anschluß an die Brausebatterie ■ in der Neigung und Höhe verstellbare Brausehalterung ■ Ausladung 360 - 380 mm 	Supply pipe, diverter, wall bracket <ul style="list-style-type: none"> ■ to connect the exposed shower mixer ■ fitting for handshower adjustable in height and inclination ■ projection 360 - 380 mm 	A	B	C	D	E
			568,-	925,-	1.161,-	1.235,-	1.710,-
			G	H	I	K	L
			1.314,-	1.649,-	1.957,-	2.153,-	2.796,-
	632.13.705 Brausegarnitur <ul style="list-style-type: none"> ■ Metall-Handbrause mit Anti-Kalk-System und Rückflussverhinderer ■ Metall-Brauseschlauch 1.500 mm, einseitig mit drehbarem Konus 	Shower combination <ul style="list-style-type: none"> ■ metal hand shower with anticalc. system and backflow preventer ■ metal shower hose 1.500 mm, one side with turning cone 	A	B	C	D	E
			279,-	499,-	546,-	648,-	796,-
			G	H	I	K	L
			598,-	896,-	1.138,-	1.252,-	1.379,-
	637.20.210 Aufputz-Brausebatterie ½" <ul style="list-style-type: none"> ■ für Steigrohr, Brauseabgang ¾" 	Exposed shower mixer ½" <ul style="list-style-type: none"> ■ for supply pipe, discharge ¾" 	A	B	C	D	E
			590,-	747,-	849,-	930,-	1.075,-
			G	H	I	K	L
			1.084,-	1.332,-	1.215,-	1.337,-	2.359,-

637.20.460 – Set mit Steigrohr (bestehend aus:) | set with shower system (consisting of:)

	649.13.920 Regenbrause ½", ø 200 mm <ul style="list-style-type: none"> ■ Ausführung ganz in Metall ■ mit Kugelgelenk ■ Anti-Kalk-System 	Rain shower head ½", ø 200 mm <ul style="list-style-type: none"> ■ full metal body ■ with ball joint ■ with anticalcareous system 	A	B	C	D	E
			260,-	619,-	824,-	895,-	1.268,-
			G	H	I	K	L
			821,-	1.098,-	1.389,-	1.528,-	2.189,-
	649.20.281 Steigrohr, Umstellung, Wandarm <ul style="list-style-type: none"> ■ zum Anschluß an die Brausebatterie ■ in der Neigung und Höhe verstellbare Brausehalterung ■ Ausladung 360 - 380 mm 	Supply pipe, diverter, wall bracket <ul style="list-style-type: none"> ■ to connect the exposed shower mixer ■ fitting for handshower adjustable in height and inclination ■ projection 360 - 380 mm 	A	B	C	D	E
			568,-	925,-	1.161,-	1.235,-	1.710,-
			G	H	I	K	L
			1.314,-	1.649,-	1.957,-	2.153,-	2.796,-
	632.13.705 Brausegarnitur <ul style="list-style-type: none"> ■ Metall-Handbrause mit Anti-Kalk-System und Rückflussverhinderer ■ Metall-Brauseschlauch 1.500 mm, einseitig mit drehbarem Konus 	Shower combination <ul style="list-style-type: none"> ■ metal hand shower with anticalc. system and backflow preventer ■ metal shower hose 1.500 mm, one side with turning cone 	A	B	C	D	E
			279,-	499,-	546,-	648,-	796,-
			G	H	I	K	L
			598,-	896,-	1.138,-	1.252,-	1.379,-
	637.20.260 Aufputz-Brausethermostat ½" <ul style="list-style-type: none"> ■ für Steigrohr, Brauseabgang ¾" 	Exposed shower thermostat ½" <ul style="list-style-type: none"> ■ for supply pipe, discharge ¾" 	A	B	C	D	E
			1.199,-	1.614,-	1.784,-	1.909,-	2.564,-
			G	H	I	K	L
			1.878,-	2.304,-	2.869,-	3.156,-	3.369,-

CRONOS CRYSTAL

Maßzeichnungen unter www.joerger.de - Menü SERVICE.
 Technical specifications under www.joerger.de - menu SERVICE.

A chrom chrome	[.000]	E platin matt platinum matt	[.066]
B silbernickel polished nickel	[.035]	G schwarz-matt black matt	[.092]
C nerz milk	[.095]	G weiß-matt white matt	[.052]
C nickel matt satin nickel	[.036]	H bronze bronze	[.011]
D edelmessing sunshine	[.040]	I gold gold	[.020]
D platin platinum	[.065]	K alt-gold antique-gold	[.025]
E edelmess.matt sunshine matt	[.041]	L roségold rosegold	[.022]
E gold matt gold matt	[.021]	L roségold matt rosegold matt	[.023]

-11 kristallklar | clear as crystal

Die Artikelnummer wird um weitere 2 Ziffern erweitert. Beispiel:
 Waschtisch 3-Loch Batterie in chrom mit Griffen in kristallklar:

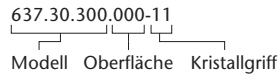

The article number needs to be added by 2 additional figures. For example:
 washbasin 3-hole mixer in chrome with handles in clear as crystal:

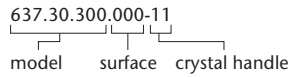

Unterputz-Thermostate 1/2" | Wall thermostats, concealed 1/2"



637.40.380 Unterputz-Thermostat 1/2"
mit Mengenregulierung,
 Fertigmontageset

- manuelle, keramische Umstellung Wanne/Brause, druckunabhängig
- mit Sicherheitseinrichtung
- Durchflussrate 20,4 l/min bei 3 bar

Concealed wall thermostat 1/2"
with flow control,
 assembly set

- manual, ceramic diverter tub/shower for pressure-independent function
- with safety device
- flow rate 20,4 l/min at 3 bar

A	B	C	D	E
1.225,-	1.399,-	1.519,-	1.560,-	1.859,-
G	H	I	K	L
1.492,-	1.764,-	2.157,-	2.373,-	2.595,-

Variante | Alternative



637.40.360 Unterputz-Thermostat 1/2"
mit Mengenregulierung,
 Fertigmontageset

- ohne Umstellung
- mit integrierter keramischer Mengenregulierung
- Durchflussrate 20,4 l/min bei 3 bar

Concealed wall thermostat 1/2"
with flow control,
 assembly set

- without diverter
- with integrated ceramic cartridge for volume control
- flow rate 20,4 l/min at 3 bar

A	B	C	D	E
1.212,-	1.354,-	1.485,-	1.525,-	1.823,-
G	H	I	K	L
1.484,-	1.754,-	2.122,-	2.335,-	2.529,-

Variante | Alternative



637.40.460 Unterputz-Thermostat 1/2"
ohne Mengenregulierung,
 Fertigmontageset

- Funktionseinheit ohne Umstellung und ohne Absperrung
- Durchflussrate 25,8 l/min bei 3 bar

Concealed wall thermostat 1/2"
without flow control,
 assembly set

- Functional unit without diverter and without shut-off
- flow rate 25,8 l/min at 3 bar

A	B	C	D	E
884,-	1.038,-	1.220,-	1.279,-	1.539,-
G	H	I	K	L
1.196,-	1.462,-	1.710,-	1.881,-	2.018,-

Benötigt | Required



649.40.360 Unterputz-Einbaubox 1/2"

- zu Fertigmontageset 637.40.360, 637.40.380 und 637.40.460
- für Nass- und Trockenbau geeignet

Concealed wall box 1/2"

- for assembly set 637.40.360, 637.40.380 and 637.40.460
- for wetwall and drywall construction

A	B	C	D	E
168,-				

Unterputz-Thermostat 3/4" mit hohem Durchfluß | Wall thermostat, concealed 3/4" with high flow



637.40.555 Unterputz-Thermostat 3/4"
ohne Mengenregulierung,
 Fertigmontageset

- serienbezogener Temperiergriff
- Sicherheitssperre bei 38° C

Concealed wall thermostat 3/4"
without flow control,
 assembly set

- design handle for temp. control
- locking device at 38° C

A	B	C	D	E
599,-	619,-	985,-	1.096,-	1.338,-
G	H	I	K	L
961,-	829,-	1.642,-	1.807,-	1.934,-

Benötigt | Required



649.40.555 Unterputz-Einbaukörper 3/4"

- zu Fertigmontageset 637.40.555
- Kartusche mit Schmutzfangsieben
- für Nass- und Trockenbau geeignet
- Durchflussrate 64,2 l/min bei 3 bar
- ohne Absperrung

Concealed thermostat body 3/4"

- for assembly set 637.40.555
- cartridge with filter screens
- for wetwall and drywall construction
- flow rate 64,2 l/min at 3 bar
- without shut-off

A	B	C	D	E
1.636,-				

CRONOS CRYSTAL

Maßzeichnungen unter www.joerger.de - Menü SERVICE.
 Technical specifications under www.joerger.de - menu SERVICE.

A chrom chrome	[.000]	E platin matt platinum matt	[.066]
B silbernicked polished nickel	[.035]	G schwarz-matt black matt	[.092]
C nerz milk	[.095]	G weiß-matt white matt	[.052]
C nickel matt satin nickel	[.036]	H bronze bronze	[.011]
D edelmessing sunshine	[.040]	I gold gold	[.020]
D platin platinum	[.065]	K alt-gold antique-gold	[.025]
E edelmess.matt sunshine matt	[.041]	L roségold rosegold	[.022]
E gold matt gold matt	[.021]	L roségold matt rosegold matt	[.023]

-11 kristallklar | clear as crystal

Die Artikelnummer wird um weitere 2 Ziffern erweitert. Beispiel:
 Waschtisch 3-Loch Batterie in chrom mit Griffen in kristallklar:

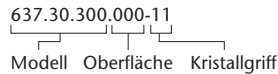

The article number needs to be added by 2 additional figures. For example:
 washbasin 3-hole mixer in chrome with handles in clear as crystal:

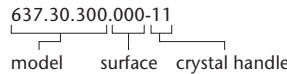

Unterputz-Thermostat 3/4" | Wall thermostat, concealed 3/4"



637.40.520 Unterputz-Thermostat 3/4"
ohne Mengenregulierung,
 Fertigmontageset

- serienbezogener Temperiergriff
- Sicherheitsperre bei 38° C

Concealed wall thermostat 3/4"
without flow control,
 assembly set

- design handle for temp. control
- locking device at 38°C

A	B	C	D	E
599,-	619,-	985,-	1.096,-	1.338,-
G	H	I	K	L
961,-	829,-	1.642,-	1.807,-	1.934,-

Benötigt | Required



649.40.520 Unterputz-Einbaukörper 3/4"
 zu Fertigmontageset 637.40.520

- Kartusche mit Schmutzfangsieben
- für Nass- und Trockenbau geeignet
- Durchflussrate 41 l/min bei 3 bar
- ohne Absperrung

Concealed thermostat body 3/4"
 for assembly set 637.40.520

- cartridge with filter screens
- for wetwall and drywall construction
- flow rate 41 l/min at 3 bar
- without shut-off

A	B	C	D	E
498,-				

Unterputz-Umstellung | Diverter, concealed



637.40.650 Unterputz 3-Wege Umstellung
 Fertigmontageset

- mit Kristallgriff
- Hülse
- Schubrosette

Concealed 3-position diverter
 assembly set

- with crystal handle
- socket with adjustable escutcheon

A	B	C	D	E
426,-	479,-	495,-	512,-	615,-
G	H	I	K	L
496,-	576,-	732,-	806,-	976,-

Benötigt | Required



649.40.600 Unterputz 3-Wege Umstellung
 Einbaukörper 1/2"

- zu Fertigmontageset 637.40.650

Concealed 3-position diverter
 diverter body 1/2"

- for assembly set 637.40.650

A	B	C	D	E
236,-				

Unterputz-Ventile | Valves, concealed



637.50.234 Unterputz-Ventil
 Fertigmontageset

- mit Kristallgriff
- Hülse
- Schubrosette

Concealed wall valve
 assembly set

- with crystal handle
- socket with adjustable escutcheon

A	B	C	D	E
426,-	479,-	495,-	512,-	615,-
G	H	I	K	L
496,-	576,-	732,-	806,-	976,-

Benötigt | Required



649.20.350 Unterputz-Ventil 1/2", Einbaukörper
 rechtsschließend, ker. Scheiben

Concealed wall valve 1/2", body
 clockwise closure, ceramic discs

A	B	C	D	E
66,-				

649.20.355 Unterputz-Ventil 1/2", Einbaukörper
 linksschließend, ker. Scheiben

Concealed wall valve 1/2", body
 counter-clockwise closure, cer. discs



649.20.450 Unterputz-Ventil 3/4", Einbaukörper
 rechtsschließend, ker. Scheiben

Concealed wall valve 3/4", body
 clockwise closure, ceramic discs

A	B	C	D	E
99,-				

649.20.455 Unterputz-Ventil 3/4", Einbaukörper
 linksschließend, ker. Scheiben

Concealed wall valve 3/4", body
 counter-clockwise closure, cer. discs

CRONOS CRYSTAL

Maßzeichnungen unter www.joerger.de - Menü SERVICE.
 Technical specifications under www.joerger.de - menu SERVICE.

A chrom chrome	[.000]	E platin matt platinum matt	[.066]
B silbernickel polished nickel	[.035]	G schwarz-matt black matt	[.092]
C nerz mink	[.095]	G weiß-matt white matt	[.052]
C nickel matt satin nickel	[.036]	H bronze bronze	[.011]
D edelmessing sunshine	[.040]	I gold gold	[.020]
D platin platinum	[.065]	K alt-gold antique-gold	[.025]
E edelmess.matt sunshine matt	[.041]	L roségold rosegold	[.022]
E gold matt gold matt	[.021]	L roségold matt rosegold matt	[.023]

-11 kristallklar | clear as crystal

Die Artikelnummer wird um weitere 2 Ziffern erweitert. Beispiel: Waschtisch 3-Loch Batterie in chrom mit Griffen in kristallklar:

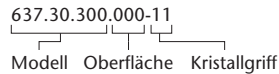

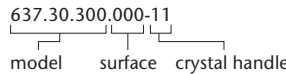

The article number needs to be added by 2 additional figures. For example: washbasin 3-hole mixer in chrome with handles in clear as crystal:



Unterputz-Thermostat/Ventil-Modul | Concealed thermostatic/wall-valve modul



	637.60.432 Unterputz-Ventil-Modul Fertigmontageset	Concealed wall-valve-modul assembly set	A	B	C	D	E
			378,-	405,-	416,-	429,-	479,-
	<ul style="list-style-type: none"> mit Kristallgriff Rosette 	<ul style="list-style-type: none"> with crystal handle escutcheon 	G	H	I	K	L
			459,-	559,-	668,-	735,-	844,-

Benötigt | Required

	649.20.610 Unterputz-Ventil-Modul, 1-fach	Concealed wall-valve-modul, single	A				
			229,-				
	<ul style="list-style-type: none"> 1x Spindelventil 3/4", rechtsschließend mit keram. Scheiben 2 Abgänge 1/2", je 1x rechts/links möglich, gleichzeitig benutzbar 	<ul style="list-style-type: none"> 1x spindle valve 3/4", clockwise closure with ceramic discs 2 outlets 1/2", each 1x right/left possible, simultaneously usable 					
	649.20.620 Unterputz-Ventil-Modul, 2-fach	Concealed wall-valve-modul, double	A				
			458,-				
	<ul style="list-style-type: none"> 2x Spindelventil 3/4", rechtsschließend mit keram. Scheiben 4 Abgänge 1/2", je 2x rechts/links möglich, gleichzeitig benutzbar im Verbund maßgenaue Montage erweiterbar mit 649.20.610 	<ul style="list-style-type: none"> 2x spindle valve 3/4", clockwise closure with ceramic discs 4 outlets 1/2", each 2x right/left possible, simultaneously usable precise assembly due to composite expandable with 649.20.610 					
	649.20.630 Unterputz-Ventil-Modul, 3-fach	Concealed wall-valve-modul, triple	A				
			686,-				
	<ul style="list-style-type: none"> 3x Spindelventil 3/4", rechtsschließend mit keram. Scheiben 6 Abgänge 1/2", je 3x rechts/links möglich, gleichzeitig benutzbar im Verbund maßgenauen Montage erweiterbar mit 649.20.610 	<ul style="list-style-type: none"> 3x spindle valve 3/4", clockwise closure with ceramic discs 6 outlets 1/2", each 3x right/left possible, simultaneously usable precise assembly due to composite expandable with 649.20.610 					

	637.40.460 Unterputz-Thermostat 1/2" ohne Mengenregulierung, Fertigmontageset	Concealed wall thermostat 1/2" without flow control, assembly set	A	B	C	D	E
			884,-	1.038,-	1.220,-	1.279,-	1.539,-
	<ul style="list-style-type: none"> Funktionseinheit <u>ohne</u> Umstellung und <u>ohne</u> Absperrung Durchflussrate 25,8 l/min bei 3 bar 	<ul style="list-style-type: none"> Functional unit <u>without</u> diverter and <u>without</u> shut-off flow rate 25,8 l/min at 3 bar 	G	H	I	K	L
			1.196,-	1.462,-	1.710,-	1.881,-	2.018,-

Benötigt | Required

	649.20.612 Anschlußadapter 1/2"	Connection adapter 1/2"	A				
			122,-				
	<ul style="list-style-type: none"> Anschlußadapter, Abschlußstopfen passend zu Einbaubox 649.40.360 	<ul style="list-style-type: none"> connection adapter, end plug matching to wall box 649.40.360 					
	649.40.360 Unterputz-Einbaubox 1/2"	Concealed wall box 1/2"	A				
			168,-				
	<ul style="list-style-type: none"> zu Fertigmontageset 637.40.460 für Nass- und Trockenbau geeignet 	<ul style="list-style-type: none"> for assembly set 637.40.460 for wetwall and drywall construction 					

CRONOS CRYSTAL

Maßzeichnungen unter www.joerger.de - Menü SERVICE.
 Technical specifications under www.joerger.de - menu SERVICE.

A chrom chrome	[.000]	E platin matt platinum matt	[.066]
B silbernickel polished nickel	[.035]	G schwarz-matt black matt	[.092]
C nerz mink	[.095]	G weiß-matt white matt	[.052]
C nickel matt satin nickel	[.036]	H bronze bronze	[.011]
D edelmessing sunshine	[.040]	I gold gold	[.020]
D platin platinum	[.065]	K alt-gold antique-gold	[.025]
E edelmess.matt sunshine matt	[.041]	L roségold rosegold	[.022]
E gold matt gold matt	[.021]	L roségold matt rosegold matt	[.023]

-11 kristallklar | clear as crystal

Die Artikelnummer wird um weitere 2 Ziffern erweitert. Beispiel:
 Waschtisch 3-Loch Batterie in chrom
 mit Griffen in kristallklar:

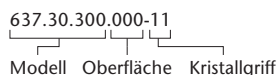

The article number needs to be added
 by 2 additional figures. For example:
 washbasin 3-hole mixer in chrome with
 handles in clear as crystal:

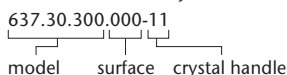

Unterputz-Thermostat/Ventil-Modul | Concealed thermostatic/wall-valve modul



637.40.555 Unterputz-Thermostat ¾"
ohne Mengenregulierung,
 Fertigmontageset

- serienbezogener Temperiergriff
- Sicherheitsperre bei 38° C

Concealed wall thermostat ¾"
without flow control,
 assembly set

- design handle for temp. control
- locking device at 38° C

A	B	C	D	E
599,-	619,-	985,-	1.096,-	1.338,-
G	H	I	K	L
961,-	829,-	1.642,-	1.807,-	1.934,-

Benötigt | Required



649.20.634 Anschlußadapter ¾"
 ■ Anschlußadapter, Abschlußstopfen
 ■ passend zu Einbaukörper 649.40.555

Connection adapter ¾"
 ■ connection adapter, end plug
 ■ matching to wall body 649.40.555

A	B	C	D	E
146,-				



649.40.555 Unterputz-Einbaukörper ¾"
 ■ zu Fertigmontageset 637.40.555
 ■ Kartusche mit Schmutzfangsieben
 ■ für Nass- und Trockenbau geeignet
 ■ Durchflußrate 64,2 l/min bei 3 bar
 ■ ohne Absperrung

Concealed thermostat body ¾"
 ■ for assembly set 637.40.555
 ■ cartridge with filter screens
 ■ for wetwall and drywall construction
 ■ flow rate 64,2 l/min at 3 bar
 ■ without shut-off

A	B	C	D	E
1.636,-				

Brausen | Showers



637.13.302 Duschgarnitur, komplett
 ■ Wandrohr 780 mm, mit Schieber
 ■ Metall-Handbrause mit Anti-Kalk-System und Rückflussverhinderer
 ■ Metall-Brauseschlauch 1750 mm, beidseitig mit drehbarem Konus

Shower bar set, complete
 ■ wall bar 780 mm, with slider
 ■ metal hand shower with anticalc. system and backflow preventer
 ■ metal shower hose 1750 mm, both sides with turning cone

A	B	C	D	E
998,-	1.462,-	1.568,-	1.764,-	2.029,-
G	H	I	K	L
1.638,-	2.078,-	2.284,-	2.513,-	3.246,-

637.13.350 Duschstange, lose
 ■ Wandrohr 780 mm, mit Schieber

Shower bar, separate
 ■ wall bar 780 mm, with slider

A	B	C	D	E
808,-	1.032,-	1.129,-	1.274,-	1.464,-
G	H	I	K	L
1.204,-	1.374,-	1.692,-	1.862,-	2.149,-

637.13.202 Schlauchbrausegarnitur
 ■ Wandanschlußbogen ½", Schubrossette, Wand-Brausehalter
 ■ Metall-Handbrause mit Anti-Kalk-System und Rückflussverhinderer
 ■ Metall-Brauseschlauch 1500 mm

Shower combination
 ■ wall elbow connection ½"
 ■ wall fitting for hand shower
 ■ metal hand shower with anticalc. system and backflow preventer
 ■ flexible metal shower hose 1500 mm

A	B	C	D	E
509,-	738,-	798,-	887,-	1.046,-
G	H	I	K	L
884,-	1.286,-	1.166,-	1.283,-	1.819,-



637.13.237 Hygienebrausegarnitur
 ■ Wandbrausehalter und -anschlußbogen ½", Schubrossette
 ■ Hygienebrause, klassisch (649.13.338), komplett aus Metall
 ■ einstrahlig, Bedienung über Druckhebel
 ■ Metall-Brauseschlauch 1250 mm

Ablution spray combination
 ■ wall fitting and elbow connection ½"
 ■ spray handshower, classical (649.13.338), completely metal
 ■ one jet, push-lever operation
 ■ flexible metal shower hose 1250 mm

A	B	C	D	E
321,-	383,-	624,-	654,-	872,-
G	H	I	K	L
699,-	1.028,-	1.113,-	1.225,-	1.559,-

CRONOS CRYSTAL

Maßzeichnungen unter www.joerger.de - Menü SERVICE.
 Technical specifications under www.joerger.de - menu SERVICE.

A chrom chrome	[.000]	E platin matt platinum matt	[.066]
B silbernickel polished nickel	[.035]	G schwarz-matt black matt	[.092]
C nerz milk	[.095]	G weiß-matt white matt	[.052]
C nickel matt satin nickel	[.036]	H bronze bronze	[.011]
D edelmessing sunshine	[.040]	I gold gold	[.020]
D platin platinum	[.065]	K alt-gold antique-gold	[.025]
E edelmess.matt sunshine matt	[.041]	L roségold rosegold	[.022]
E gold matt gold matt	[.021]	L roségold matt rosegold matt	[.023]







	637.20.237 1-Hand Batterie 1/2" für Hygiene-Brause, Fertigmontageset <ul style="list-style-type: none"> ■ Rosette, Griff ■ mit Kristallgriff 	Concealed single lever 1/2" for ablution spray, assembly set <ul style="list-style-type: none"> ■ escutcheon, handle ■ with crystal handle 	A	B	C	D	E	
			344,-	494,-	554,-	619,-	724,-	
	Benötigt Required		G	H	I	K	L	
		469,-	624,-	839,-	923,-	964,-		
	649.20.237 Unterputz 1-Hand Batterie 1/2", Einbaukörper <ul style="list-style-type: none"> ■ Kartusche mit keramischen Scheiben ■ zu Fertigmontageset 129.20.237 	Single lever mixer 1/2", concealed body <ul style="list-style-type: none"> ■ cartridge with ceramic discs ■ for assembly set 129.20.237 	A	B	C	D	E	
			125,-	169,-	208,-	229,-	268,-	
			G	H	I	K	L	
		224,-	258,-	329,-	362,-	396,-		
	649.13.930 Regenbrause 1/2", ø 300 mm <ul style="list-style-type: none"> ■ Ausführung ganz in Metall ■ mit Kugelgelenk ■ Anti-Kalk-System ■ ohne Wandarm 	Rain shower head 1/2", ø 300 mm <ul style="list-style-type: none"> ■ full metal body ■ with ball joint ■ with anticalcareous system ■ without wall bracket 	A	B	C	D	E	
			776,-	1.279,-	1.446,-	1.524,-	2.092,-	
			G	H	I	K	L	
		1.479,-	2.110,-	2.242,-	2.467,-	3.364,-		
	637.13.625 Wandarm 1/2" <ul style="list-style-type: none"> ■ Ausladung 400 mm ■ weitere, zur Serie passende Kopfbrausen und Wandarme siehe Kapitel "Brausen" 	Wall bracket 1/2" <ul style="list-style-type: none"> ■ projection 400 mm ■ for further shower heads and wall brackets matching this collection see chapter "showers" 	A	B	C	D	E	
			294,-	547,-	648,-	728,-	929,-	
			G	H	I	K	L	
		496,-	569,-	947,-	1.042,-	1.179,-		
	649.13.615 Stachelkopfbrause 1/2" <ul style="list-style-type: none"> ■ ø 230 mm, 75 Düsen ■ Ausführung ganz in Metall ■ Anti-Kalk-System ■ Brausekopf schwenkbar ■ ohne Wandarm 	Body spray shower head 1/2" <ul style="list-style-type: none"> ■ ø 230 mm, 75 jets ■ full metal body ■ anticalcareous system ■ swivel shower head ■ without wall bracket 	A	B	C	D	E	
			969,-	1.232,-	1.359,-	1.416,-	1.659,-	
			G	H	I	K	L	
		1.399,-	1.718,-	2.262,-	2.489,-	2.739,-		
	649.13.625 Wandarm 1/2" <ul style="list-style-type: none"> ■ Ausladung 162 mm ■ weitere, zur Serie passende Kopfbrausen und Wandarme siehe Kapitel "Brausen" 	Wall bracket 1/2" <ul style="list-style-type: none"> ■ projection 162 mm ■ for further shower heads and wall brackets matching this collection see chapter "showers" 	A	B	C	D	E	
			126,-	145,-	171,-	189,-	250,-	
			G	H	I	K	L	
		192,-	296,-	286,-	315,-	499,-		
	649.13.519 Seitenbrause 1/2" <ul style="list-style-type: none"> ■ Rosette ø 130 mm, Wandmontage ■ Brausekopf schwenkbar, 20° ■ Anti-Kalk-System ■ Ausführung Kunststoff ■ weitere, zur Serie passende Seitenbrausen siehe Kapitel "Brausen" 	Body spray side shower 1/2" <ul style="list-style-type: none"> ■ escutcheon ø 130 mm, wall assembly ■ swivel shower head, 20° ■ anticalcareous system ■ plastic ■ for further side showers matching this collection see chapter "showers" 	A	B	C	D	E	
			167,-	326,-	385,-	399,-	542,-	
			G	H	I	K	L	
		376,-	472,-	634,-	698,-	949,-		

CRONOS CRYSTAL

Maßzeichnungen unter www.joerger.de - Menü SERVICE.
 Technical specifications under www.joerger.de - menu SERVICE.

A chrom chrome	[.000]	E platin matt platinum matt	[.066]
B silbernickel polished nickel	[.035]	G schwarz-matt black matt	[.092]
C nerz nick	[.095]	G weiß-matt white matt	[.052]
C nickel matt satin nickel	[.036]	H bronze bronze	[.011]
D edelmessing sunshine	[.040]	I gold gold	[.020]
D platin platinum	[.065]	K alt-gold antique-gold	[.025]
E edelmess.matt sunshine matt	[.041]	L roségold rosegold	[.022]
E gold matt gold matt	[.021]	L roségold matt rosegold matt	[.023]

Accessoires für Handtücher | Accessories for towels







		A	B	C	D	E
	637.00.002 Handtuchhalter, doppelt ■ Rohre schwenkbar, ca. 430 mm	Double towel bar ■ swivelling bars, approx. 430 mm				
		342,-	482,-	524,-	576,-	712,-
		624,-	746,-	783,-	862,-	1.248,-
	637.00.047 Handtuchring ■ ø ca. 190 mm ■ geschlossene Ausführung	Towel ring ■ ø approx. 190 mm ■ closed version				
		279,-	366,-	426,-	458,-	607,-
		415,-	490,-	676,-	744,-	848,-
	637.00.022 Handtuchhaken, doppelt	Double robe hanger				
		164,-	208,-	255,-	269,-	348,-
		268,-	322,-	378,-	416,-	559,-
	637.00.040 Badetuchhalter ■ ca. 800 mm	Bath towel bar ■ approx. 800 mm				
		499,-	610,-	679,-	768,-	976,-
		679,-	878,-	1.120,-	1.232,-	1.696,-
	637.00.030 Duschtürgriff ■ ca. 580 mm	Shower door handle ■ approx. 580 mm				
		855,-	1.039,-	1.205,-	1.319,-	1.646,-
		1.229,-	1.525,-	1.886,-	2.075,-	2.769,-
	637.00.031 Wannengriff ■ ca. 370 mm	Tub handle ■ approx. 370 mm				
		439,-	519,-	579,-	652,-	792,-
		579,-	734,-	942,-	1.037,-	1.376,-
	637.00.104 Gästehandtuchkorb, eckig ■ mit Ablage ■ Korbgröße 260 x 150 x 190 mm	Guest towel basket, angular ■ with shelf ■ basket size 260 x 150 x 190 mm				
		494,-	639,-	693,-	783,-	916,-
		693,-	949,-	1.022,-	1.125,-	1.858,-

CRONOS CRYSTAL

Maßzeichnungen unter www.joerger.de - Menü SERVICE.
 Technical specifications under www.joerger.de - menu SERVICE.

A chrom chrome	[.000]	E platin matt platinum matt	[.066]
B silbernickel polished nickel	[.035]	G schwarz-matt black matt	[.092]
C nerz milk	[.095]	G weiß-matt white matt	[.052]
C nickel matt satin nickel	[.036]	H bronze bronze	[.011]
D edelmessing sunshine	[.040]	I gold gold	[.020]
D platin platinum	[.065]	K alt-gold antique-gold	[.025]
E edelmess.matt sunshine matt	[.041]	L roségold rosegold	[.022]
E gold matt gold matt	[.021]	L roségold matt rosegold matt	[.023]

Accessoires für Waschplatz | Accessories for washstands

	637.00.007 Seifenhalter, komplett	Soap dish holder, complete	A	B	C	D	E
	<ul style="list-style-type: none"> Seifenschale aus Kristallglas, seidenmatt 	<ul style="list-style-type: none"> crystal glass dish, frosted 	234,-	279,-	305,-	334,-	362,-
			G	H	I	K	L
			296,-	354,-	442,-	487,-	552,-
			A				
			90,-				
			A	B	C	D	E
	631.00.017 Seifenhalter, komplett	Soap dish holder, complete	159,-	189,-	205,-	237,-	279,-
	<ul style="list-style-type: none"> Standmodell Seifenschale aus Kristallglas 	<ul style="list-style-type: none"> free standing version crystal glass dish 	G	H	I	K	L
			236,-	295,-	307,-	338,-	480,-
			A	B	C	D	E
	637.00.105 Schwammkorb	Sponge basket	388,-	497,-	544,-	615,-	719,-
	<ul style="list-style-type: none"> rechteckig, 260 x 130 mm 	<ul style="list-style-type: none"> rectangular, 260 x 130 mm 	G	H	I	K	L
			519,-	709,-	799,-	879,-	1.219,-
			A	B	C	D	E
	637.00.106 Eckschwammkorb	Corner sponge basket	417,-	518,-	566,-	640,-	748,-
	<ul style="list-style-type: none"> 195 x 195 mm 	<ul style="list-style-type: none"> 195 x 195 mm 	G	H	I	K	L
			534,-	734,-	838,-	922,-	1.199,-
			A	B	C	D	E
	637.00.006 Lotionsspender, komplett	Soap dispenser, complete	299,-	326,-	355,-	398,-	426,-
	<ul style="list-style-type: none"> Glas aus Kristallglas, seidenmatt 	<ul style="list-style-type: none"> crystal glass, frosted 	G	H	I	K	L
			340,-	429,-	497,-	547,-	759,-
			A				
			96,-				
			A	B	C	D	E
	631.00.016 Lotionsspender, komplett	Soap dispenser, complete	189,-	224,-	242,-	277,-	323,-
	<ul style="list-style-type: none"> Standmodell Glas aus Kristallglas, seidenmatt 	<ul style="list-style-type: none"> free standing version crystal glass, frosted 	G	H	I	K	L
			295,-	378,-	448,-	493,-	718,-

CRONOS CRYSTAL

Maßzeichnungen unter www.joerger.de - Menü SERVICE.
 Technical specifications under www.joerger.de - menu SERVICE.

A chrom chrome	[.000]	E platin matt platinum matt	[.066]
B silbernickel polished nickel	[.035]	G schwarz-matt black matt	[.092]
C nerz milk	[.095]	H weiß-matt white matt	[.052]
C nickel matt satin nickel	[.036]	H bronze bronze	[.011]
D edelmessing sunshine	[.040]	I gold gold	[.020]
D platin platinum	[.065]	K alt-gold antique-gold	[.025]
E edelmess.matt sunshine matt	[.041]	L roségold rosegold	[.022]
E gold matt gold matt	[.021]	L roségold matt rosegold matt	[.023]



637.00.036 Glashalter, komplett
 ■ Glas aus Kristallglas, seidenmatt

Tumbler holder, complete
 ■ crystal glass tumbler, frosted

A	B	C	D	E
246,-	284,-	308,-	339,-	367,-
G	H	I	K	L
298,-	357,-	445,-	490,-	557,-

737.00.336 Mundglas, lose

Glass tumbler, separate

A	B	C	D	E
92,-				



631.00.046 Glashalter, komplett
 ■ Standmodell
 ■ Glas aus Kristallglas, seidenmatt

Tumbler holder, complete
 ■ free standing version
 ■ crystal glass tumbler, frosted

A	B	C	D	E
169,-	199,-	215,-	247,-	289,-
G	H	I	K	L
246,-	305,-	317,-	349,-	490,-

Accessoires für WC-Bereich | Accessories for w.c. area



637.00.014 Papierhalter
 ■ mit Deckel

Toilet paper roll holder
 ■ with lid

A	B	C	D	E
257,-	312,-	349,-	392,-	472,-
G	H	I	K	L
418,-	629,-	676,-	744,-	1.096,-



637.00.015 Reserve-Papierhalter

Spare toilet paper roll holder

A	B	C	D	E
239,-	296,-	332,-	369,-	447,-
G	H	I	K	L
397,-	597,-	647,-	712,-	1.035,-



631.00.001 Klosettbürstengarnitur, komplett
 ■ stehendes Modell
 ■ Bürstentopf aus Metall

Toilet brush holder set, complete
 ■ floor standing model
 ■ brush holder out of brass

A	B	C	D	E
292,-	335,-	354,-	399,-	556,-
G	H	I	K	L
444,-	684,-	924,-	1.017,-	1.289,-

CRONOS CRYSTAL

Maßzeichnungen unter www.joerger.de - Menü SERVICE.
 Technical specifications under www.joerger.de - menu SERVICE.

A chrom chrome	[.000]	E platin matt platinum matt	[.066]
B silbernickel polished nickel	[.035]	G schwarz-matt black matt	[.092]
C nerz mink	[.095]	G weiß-matt white matt	[.052]
C nickel matt satin nickel	[.036]	H bronze bronze	[.011]
D edelmessing sunshine	[.040]	I gold gold	[.020]
D platin platinum	[.065]	K alt-gold antique-gold	[.025]
E edelmess.matt sunshine matt	[.041]	L roségold rosegold	[.022]
E gold matt gold matt	[.021]	L roségold matt rosegold matt	[.023]

	637.00.000 Klosettbürstengarnitur, komplett ■ Glas aus Kristallglas, seidenmatt	Toilet brush holder set, complete ■ crystal glass, frosted	A	B	C	D	E
			382,-	439,-	464,-	490,-	552,-
			G	H	I	K	L
			447,-	592,-	760,-	836,-	942,-
799.00.301 Bürstenglas, seidenmatt, lose			Brush glass, frosted, separate				
		A					
		29,-					
687.00.053 Bürstenstange komplett, lose			Brush rod with brush, separate				
		A	B	C	D	E	
		178,-	204,-	215,-	228,-	257,-	
		G	H	I	K	L	
		208,-	275,-	339,-	373,-	438,-	
799.00.240 Bürstenkopf, lose			Brush, separate				
		A					
		19,-					

Leuchten und Spiegel | Lamps and mirrors

	637.00.061 Wandleuchte, komplett ■ mit Leuchtmittel, 40 W	Wall lamp, complete ■ light bulb included, 40 W	A	B	C	D	E
			792,-	839,-	868,-	895,-	1.054,-
			G	H	I	K	L
			1.059,-	1.159,-	1.352,-	1.488,-	1.768,-
710.00.361 Leuchtenglas <u>gewolkt</u> , lose			<u>Clouded</u> glass, separate				
		A					
		216,-					

	649.00.414 Kosmetikspiegel, beleuchtet ■ schwenk- und ausziehbar ■ 3-fache Vergrößerung ■ Direktanschluss ■ Spiegeldurchmesser 185 mm ■ Rahmendurchmesser 250 mm ■ Kalt-, Warm- und Taglicht durch Piezzo-Schalter umschaltbar	Cosmetic mirror, incl. lighting ■ swivelling and extendable ■ magnification 3:1 ■ direct connection ■ mirror diameter 185 mm ■ frame diameter 250 mm ■ cold, warm and day light switchable by Piezzo switch	A	B	C	D	E
			556,-	988,-	1.214,-	1.418,-	1.828,-
			G	H	I	K	L
			1.214,-	1.549,-	2.138,-	2.352,-	2.998,-

FLORALE CRYSTAL



Oberflächen | colours

Folgende Oberflächen sind bei dieser Serie möglich |
The following colours are possible with this collection

chrom	chrome	[.000]	PG A
silbernickel	polished nickel	[.035]	PG B
nerz	mink	[.095]	PG C
nickel matt	satin nickel	[.036]	PG C
edelmessing	sunshine	[.040]	PG D
platin	platinum	[.065]	PG D
edelmessing matt	sunshine matt	[.041]	PG E
gold matt	gold matt	[.021]	PG E
platin matt	platinum matt	[.066]	PG E
nerz matt	mink matt	[.096]	PG F
schwarz matt	black matt	[.092]	PG G
weiß matt	white matt	[.052]	PG G
bronze	bronze	[.011]	PG H
gold	gold	[.020]	PG I
roségold	rosegold	[.022]	PG L
roségold matt	rosegold matt	[.023]	PG L

Andere Oberflächen auf Anfrage |
Different colours on request

Auf Anfrage können wir Produkte von Drittanbietern auch gerne passend zu unseren Oberflächen veredeln (vorbehaltlich der Eignungsprüfung) | Third-party products may be plated matching to our colours on request (subject to valuation of suitability)

Waschtisch | Washbasin

ab Seite | from page 214

Bidet | Bidet

ab Seite | from page 214

Wanne | Bath tub

ab Seite | from page 215

Dusche | Shower

ab Seite | from page 216

Accessoires | Accessories

ab Seite | from page 222

FLORALE CRYSTAL

Maßzeichnungen unter www.joerger.de - Menü SERVICE.
 Technical specifications under www.joerger.de - menu SERVICE.

A chrom chrome	[.000]	E platin matt platinum matt	[.066]
B silbernickel polished nickel	[.035]	F nerz matt mink matt	[.096]
C nerz mink	[.095]	G schwarz-matt black matt	[.092]
C nickel matt satin nickel	[.036]	G weiß-matt white matt	[.052]
D edelmessing sunshine	[.040]	H bronze bronze	[.011]
D platin platinum	[.065]	I gold gold	[.020]
E edelmess.matt sunshine matt	[.041]	L roségold rosegold	[.022]
E gold matt gold matt	[.021]	L roségold matt rosegold matt	[.023]

-11 kristallklar clear as crystal -12 schwarz black -16 bernstein amber -17 amethyst amethyst	Die Artikelnummer wird um weitere 2 Ziffern erweitert. Beispiel: Waschtisch 3-Loch Batterie in chrom mit Griffen in kristallklar: 600.30.300.000-11 Modell Oberfläche Kristallgriff	The article number needs to be added by 2 additional figures. For example: washbasin 3-hole mixer in chrome with handles in clear as crystal: 600.30.300.000-11 model surface crystal handle
--	--	---

Waschtisch Batterien | Washbasin mixer

	600.30.300 Waschtisch 3-Loch Batterie 1/2" <ul style="list-style-type: none"> Ausladung 130 mm; Höhe 165 mm 2 Seitenrandventile mit keramischen Oberteilen 1/2" Exzenter-Ablaufgarnitur 1 1/4" empfohlen: 2x 649.15.530 - Kupferrohr 300 mm 	Washbasin 3-hole mixer 1/2" <ul style="list-style-type: none"> spout projection 130 mm; height 165 mm 2 side valves with ceramic internal upper parts 1/2" pop-up waste 1 1/4" recommended: 2x 649.15.530 - copper tube 300 mm 	<table border="1"> <tr><th>A</th><th>B</th><th>C</th><th>D</th><th>E</th></tr> <tr><td>1.239,-</td><td>1.477,-</td><td>1.698,-</td><td>1.922,-</td><td>2.173,-</td></tr> <tr><th>F</th><th>G</th><th>H</th><th>I</th><th>L</th></tr> <tr><td>2.029,-</td><td>1.666,-</td><td>1.871,-</td><td>2.387,-</td><td>2.899,-</td></tr> </table>	A	B	C	D	E	1.239,-	1.477,-	1.698,-	1.922,-	2.173,-	F	G	H	I	L	2.029,-	1.666,-	1.871,-	2.387,-	2.899,-
	A	B	C	D	E																		
	1.239,-	1.477,-	1.698,-	1.922,-	2.173,-																		
F	G	H	I	L																			
2.029,-	1.666,-	1.871,-	2.387,-	2.899,-																			

	600.10.300 Waschtisch 1-Loch Batterie 1/2" <ul style="list-style-type: none"> Ausladung 125 mm; Höhe 165 mm Keramik-Innenoberteile 1/2" Exzenter-Ablaufgarnitur 1 1/4" 2 Kupferrohre M10x1 x 400 mm 	Washbasin 1-hole mixer 1/2" <ul style="list-style-type: none"> spout projection 125 mm; height 165mm ceramic internal upper parts 1/2" pop-up waste 1 1/4" 2 copper tubes M10x1 x 400 mm 	<table border="1"> <tr><th>A</th><th>B</th><th>C</th><th>D</th><th>E</th></tr> <tr><td>1.128,-</td><td>1.366,-</td><td>1.587,-</td><td>1.811,-</td><td>2.062,-</td></tr> <tr><th>F</th><th>G</th><th>H</th><th>I</th><th>L</th></tr> <tr><td>1.918,-</td><td>1.555,-</td><td>1.760,-</td><td>2.276,-</td><td>2.788,-</td></tr> </table>	A	B	C	D	E	1.128,-	1.366,-	1.587,-	1.811,-	2.062,-	F	G	H	I	L	1.918,-	1.555,-	1.760,-	2.276,-	2.788,-
	A	B	C	D	E																		
	1.128,-	1.366,-	1.587,-	1.811,-	2.062,-																		
F	G	H	I	L																			
1.918,-	1.555,-	1.760,-	2.276,-	2.788,-																			

	600.30.360 Wand-Waschtisch 3-Loch Batterie 1/2", Fertigmontageset <ul style="list-style-type: none"> Wand-Auslauf, Ausladung 160 - 175 mm Griff, Hülse, Schubrosette Oberteile 1/2", keramische Scheiben 	Wall washbasin 3-hole mixer 1/2" assembly set <ul style="list-style-type: none"> wall spout, projection 160 - 175 mm design handle, socket with adjustable escutcheon cartridges 1/2", with ceramic discs 	<table border="1"> <tr><th>A</th><th>B</th><th>C</th><th>D</th><th>E</th></tr> <tr><td>1.174,-</td><td>1.412,-</td><td>1.633,-</td><td>1.857,-</td><td>2.108,-</td></tr> <tr><th>F</th><th>G</th><th>H</th><th>I</th><th>L</th></tr> <tr><td>1.964,-</td><td>1.599,-</td><td>1.806,-</td><td>2.322,-</td><td>2.834,-</td></tr> </table>	A	B	C	D	E	1.174,-	1.412,-	1.633,-	1.857,-	2.108,-	F	G	H	I	L	1.964,-	1.599,-	1.806,-	2.322,-	2.834,-
	A	B	C	D	E																		
	1.174,-	1.412,-	1.633,-	1.857,-	2.108,-																		
F	G	H	I	L																			
1.964,-	1.599,-	1.806,-	2.322,-	2.834,-																			

Benötigt | Required

	649.30.380 Wand-Waschtisch 3-Loch Batterie 1/2", Einbaukörper <ul style="list-style-type: none"> 2 Anschlüsse, Stichmaß 204 mm zu Fertigmontageset 600.30.360 	Wall washbasin 3-hole mixer 1/2" concealed body <ul style="list-style-type: none"> 2 connections, center distance 204 mm for assembly set 600.30.360 	<table border="1"> <tr><th>A</th><th>B</th><th>C</th><th>D</th><th>E</th></tr> <tr><td>296,-</td><td></td><td></td><td></td><td></td></tr> </table>	A	B	C	D	E	296,-				
	A	B	C	D	E								
	296,-												

Bidet Batterien | Bidet mixer

	600.10.100 Bidet 1-Loch Batterie 1/2" <ul style="list-style-type: none"> Ausladung 76 mm; Höhe 95 mm Keramik-Innenoberteile 1/2" Exzenter-Ablaufgarnitur 1 1/4" 2 Kupferrohre M10x1 x 400 mm 	Bidet 1-hole mixer 1/2" <ul style="list-style-type: none"> spout projection 76 mm; height 95 mm ceramic internal upper parts 1/2" pop-up waste 1 1/4" 2 copper tubes M10x1 x 400 mm 	<table border="1"> <tr><th>A</th><th>B</th><th>C</th><th>D</th><th>E</th></tr> <tr><td>1.220,-</td><td>1.432,-</td><td>1.709,-</td><td>1.923,-</td><td>2.265,-</td></tr> <tr><th>F</th><th>G</th><th>H</th><th>I</th><th>L</th></tr> <tr><td>2.110,-</td><td>1.568,-</td><td>1.658,-</td><td>2.555,-</td><td>2.598,-</td></tr> </table>	A	B	C	D	E	1.220,-	1.432,-	1.709,-	1.923,-	2.265,-	F	G	H	I	L	2.110,-	1.568,-	1.658,-	2.555,-	2.598,-
	A	B	C	D	E																		
	1.220,-	1.432,-	1.709,-	1.923,-	2.265,-																		
F	G	H	I	L																			
2.110,-	1.568,-	1.658,-	2.555,-	2.598,-																			

Zubehör für Waschtisch- und Bidet-Batterien | Supplies for washbasin and bidet mixer

	600.12.100 Eckventil 1/2" <ul style="list-style-type: none"> Ausladung 140 mm Fettkammer-Innenoberteil 1/2" Quetschverschraubung Schubrosette 	Angle valve 1/2" <ul style="list-style-type: none"> projection 140 mm cartridge 1/2" compression joint escutcheon 	<table border="1"> <tr><th>A</th><th>B</th><th>C</th><th>D</th><th>E</th></tr> <tr><td>340,-</td><td>385,-</td><td>417,-</td><td>458,-</td><td>523,-</td></tr> <tr><th>F</th><th>G</th><th>H</th><th>I</th><th>L</th></tr> <tr><td>488,-</td><td>406,-</td><td>485,-</td><td>572,-</td><td>739,-</td></tr> </table>	A	B	C	D	E	340,-	385,-	417,-	458,-	523,-	F	G	H	I	L	488,-	406,-	485,-	572,-	739,-
	A	B	C	D	E																		
	340,-	385,-	417,-	458,-	523,-																		
F	G	H	I	L																			
488,-	406,-	485,-	572,-	739,-																			

FLORALE CRYSTAL

Maßzeichnungen unter www.joerger.de - Menü SERVICE.
 Technical specifications under www.joerger.de - menu SERVICE.

A chrom chrome	[.000]	E platin matt platinum matt	[.066]
B silbernickel polished nickel	[.035]	F nerz matt milk matt	[.096]
C nerz milk	[.095]	G schwarz-matt black matt	[.092]
C nickel matt satin nickel	[.036]	G weiß-matt white matt	[.052]
D edelmessing sunshine	[.040]	H bronze bronze	[.011]
D platin platinum	[.065]	I gold gold	[.020]
E edelmess.matt sunshine matt	[.041]	L roségold rosegold	[.022]
E gold matt gold matt	[.021]	L roségold matt rosegold matt	[.023]

- 11 kristallklar | clear as crystal
- 12 schwarz | black
- 16 bernstein | amber
- 17 amethyst | amethyst

Die Artikelnummer wird um weitere 2 Ziffern erweitert. Beispiel:
 Waschtisch 3-Loch Batterie in chrom mit Griffen in kristallklar:

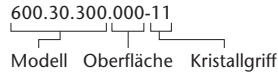

The article number needs to be added by 2 additional figures. For example:
 washbasin 3-hole mixer in chrome with handles in clear as crystal:

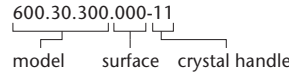

649.15.530 Kupferrohr, 300 mm
 ■ mit Bördel, für Quetschverschraubung



Copper tube, 300 mm
 ■ with flange, for compression joint

A	B	C	D	E
15,-	38,-	55,-	62,-	74,-
F	G	H	I	L
69,-	75,-	94,-	112,-	169,-

Variante | Alternative

649.15.550 Kupferrohr, 500 mm
 ■ mit Bördel, für Quetschverschraubung



Copper tube, 500 mm
 ■ with flange, for compression joint

A	B	C	D	E
20,-	58,-	77,-	87,-	102,-
F	G	H	I	L
97,-	77,-	96,-	134,-	219,-



649.15.340 Waschtisch-Tassensiphon 1 ¼"
 ■ schwere Ausführung
 ■ Rosette
 ■ Abgangsrohr ø 32 mm
 ■ Tauchrohrlänge 165 mm

Washbasin cupped siphon trap 1 ¼"
 ■ heavy brass
 ■ escutcheon
 ■ outlet tube ø 32 mm
 ■ dip pipe 165 mm

A	B	C	D	E
195,-	296,-	368,-	429,-	568,-
F	G	H	I	L
498,-	378,-	539,-	686,-	832,-



649.15.330 Bidet-Tassensiphon 1 ¼"
 ■ Rosette
 ■ Abgangsrohr ø 32 mm

Bidet cupped siphon trap 1 ¼"
 ■ escutcheon
 ■ outlet tube ø 32 mm

A	B	C	D	E
98,-	166,-	276,-	332,-	472,-
F	G	H	I	L
399,-	364,-	508,-	648,-	796,-

Badewanne, Stand-Batterien | Bath tub mixer sets, deck mount



600.40.100 4-Loch Wannenfäll- und Brausebatterie ½", für Standmontage
 ■ Ausladung 220 mm; Höhe 188 mm
 ■ 2 Seitenrandventile mit keramischen Oberteilen ½"
 ■ Metall-Brauseschlauch 2000 mm
 ■ Metall-Handbrause mit Anti-Kalk-System und Rückflussverhinderer

Tub/shower mixer set ½", deck mount
 ■ spout projection 220 mm; height 188 mm
 ■ 2 side valves, ceramic internal upper parts ½"
 ■ metal shower hose 2000 mm
 ■ metal hand shower with anticalc. system and backflow preventer

A	B	C	D	E
2.124,-	2.364,-	2.816,-	3.282,-	3.709,-
F	G	H	I	L
3.519,-	2.845,-	3.355,-	4.116,-	4.956,-

Empfohlen | Recommended



649.40.160 Montageplatte, komplett
 ■ für 4-Loch Armaturen
 ■ Druckschläuche ½" x ½" x 600 mm
 ■ empfohlen: Schlauchkastensystem siehe Kapitel "Serienübergreifendes"

Assembly plate, complete
 ■ for deck mounted tub/shower mixer
 ■ pressure hoses ½" x ½" x 600 mm
 ■ recommended: system with hose box see chapter "universal products"

A	B	C	D	E
308,-				



600.11.100 Wand-Wanneneinlauf ¾"
 ■ Ausladung 175 mm
 ■ Steckanschluß-Montage

Tub wall spout ¾"
 ■ spout projection 175 mm
 ■ special concealed wall attachment

A	B	C	D	E
729,-	799,-	864,-	916,-	1.124,-
F	G	H	I	L
1.014,-	896,-	970,-	1.393,-	1.564,-

FLORALE CRYSTAL

Maßzeichnungen unter www.joerger.de - Menü SERVICE.
 Technical specifications under www.joerger.de - menu SERVICE.

A chrom chrome	[.000]	E platin matt platinum matt	[.066]
B silbernickel polished nickel	[.035]	F nerz matt mink matt	[.096]
C nerz mink	[.095]	G schwarz-matt black matt	[.092]
C nickel matt satin nickel	[.036]	G weiß-matt white matt	[.052]
D edelmessing sunshine	[.040]	H bronze bronze	[.011]
D platin platinum	[.065]	I gold gold	[.020]
E edelmess.matt sunshine matt	[.041]	L roségold rosegold	[.022]
E gold matt gold matt	[.021]	L roségold matt rosegold matt	[.023]

- 11 kristallklar | clear as crystal
- 12 schwarz | black
- 16 bernstein | amber
- 17 amethyst | amethyst

Die Artikelnummer wird um weitere 2 Ziffern erweitert. Beispiel: Waschtisch 3-Loch Batterie in chrom mit Griffen in kristallklar:

600.30.300.000-11
 Modell Oberfläche Kristallgriff

The article number needs to be added by 2 additional figures. For example: washbasin 3-hole mixer in chrome with handles in clear as crystal:

600.30.300.000-11
 model surface crystal handle

Badewanne, Aufputz-Batterien | Bath tub mixer sets, exposed

600.20.109 Wannenfüll- und Brausebatterie ½" für Aufputzmontage, mit Garnitur



- Ausladung 145 mm
- 2 keramische Oberteile ½"
- Metall-Handbrause mit Anti-Kalk-System und Rückflussverhinderer
- Metall-Brauseschlauch 1.500 mm, beidseitig mit drehbarem Konus

Exposed tub/shower mixer ½", incl. shower set

- spout projection 145 mm
- 2 ceramic internal upper parts ½"
- metal hand shower with anticalc. system and backflow preventer
- metal shower hose 1.500 mm, both sides with turning cone

A	B	C	D	E
1.298,-	1.559,-	1.699,-	1.913,-	2.294,-
F	G	H	I	L
2.139,-	1.746,-	2.053,-	2.457,-	3.449,-

600.20.149 Wannenfüll- und Brausebatterie für Standrohrmontage, mit Garnitur



- Ausladung mit Standrohren 182 mm
- Metall-Handbrause mit Anti-Kalk-System und Rückflussverhinderer
- Metall-Brauseschlauch 1.500 mm, beidseitig mit drehbarem Konus

Tub/shower mixer for supply pipes, incl. shower set

- spout projection with pipes 182 mm
- metal hand shower with anticalc. system and backflow preventer
- metal shower hose 1.500 mm, both sides with turning cone

A	B	C	D	E
948,-	1.118,-	1.478,-	1.667,-	1.964,-
F	G	H	I	L
1.817,-	1.442,-	1.784,-	2.140,-	3.149,-

Benötigt | Required

109.15.260 Wasserzufuhrstandrohre ½"
 ■ 2 Stück, in Boden einzuschrauben
 ■ inkl. Winkelstück zum Anschluß der Wannenfüll- und Brausebatterie
 ■ Höhe 775 - 800 mm

Water supply pipes ½"
 ■ 2 pieces, floor installation
 ■ incl. angle for connecting tub/shower mixer
 ■ height 775 - 800 mm

A	B	C	D	E
888,-	1.282,-	1.672,-	1.882,-	2.219,-
F	G	H	I	L
2.095,-	1.632,-	1.952,-	2.525,-	3.488,-

Empfohlen | Recommended

109.10.970 Bausatz-Vormontage
 ■ Bodenplatte mit Befestigungsset
 ■ für Wasserzufuhrstandrohre 600.15.260



Assembly set for pre-installation
 ■ joint plate with fixing set
 ■ for water supply pipes 600.15.260

A	B	C	D	E
459,-				

Dusche, Aufputz-Batterien | Shower mixer sets, exposed

600.20.200 Brausebatterie ½" für Aufputzmontage
 ■ 2 keramische Oberteile ½"
 ■ verdeckte S-Anschlüsse ½" x ¾"



Exposed shower mixer ½"
 ■ 2 ceramic internal upper parts ½"
 ■ concealed S-connections ½" x ¾"

A	B	C	D	E
646,-	787,-	968,-	1.090,-	1.284,-
F	G	H	I	L
1.194,-	945,-	1.164,-	1.423,-	2.159,-

600.20.250 Brausethermostat ½" für Aufputzmontage
 ■ Dehnstoff-Thermoelement
 ■ Sicherheitssperre bei 38° C
 ■ Keramik-Innenoberteil ½"
 ■ verdeckte S-Anschlüsse ½" x ¾"



Exposed shower thermostat ½"
 ■ cartridge with thermoelement
 ■ heat scale, locking device at 38 °C
 ■ ceramic cartridge ½"
 ■ concealed S-connections ½" x ¾"

A	B	C	D	E
1.132,-	1.538,-	1.706,-	1.829,-	2.472,-
F	G	H	I	L
2.211,-	1.798,-	2.217,-	2.772,-	3.263,-

FLORALE CRYSTAL

Maßzeichnungen unter www.joerger.de - Menü SERVICE.
 Technical specifications under www.joerger.de - menu SERVICE.

A chrom chrome	[.000]	E platin matt platinum matt	[.066]
B silbernickel polished nickel	[.035]	F nerz matt milk matt	[.096]
C nerz milk	[.095]	G schwarz-matt black matt	[.092]
C nickel matt satin nickel	[.036]	G weiß-matt white matt	[.052]
D edelmessing sunshine	[.040]	H bronze bronze	[.011]
D platin platinum	[.065]	I gold gold	[.020]
E edelmess.matt sunshine matt	[.041]	L roségold rosegold	[.022]
E gold matt gold matt	[.021]	L roségold matt rosegold matt	[.023]

- 11 kristallklar | clear as crystal
- 12 schwarz | black
- 16 bernstein | amber
- 17 amethyst | amethyst

Die Artikelnummer wird um weitere 2 Ziffern erweitert. Beispiel:
 Waschtisch 3-Loch Batterie in chrom mit Griffen in kristallklar:

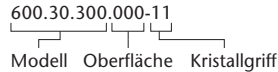

The article number needs to be added by 2 additional figures. For example:
 washbasin 3-hole mixer in chrome with handles in clear as crystal:

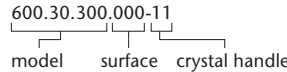

600.20.410 – Aufputz Set mit Steigrohr | Exposed set with shower system

	649.13.920 Regenbrause ½", ø 200 mm	Rain shower head ½", ø 200 mm	A	B	C	D	E
	<ul style="list-style-type: none"> ■ Ausführung ganz in Metall ■ mit Kugelgelenk ■ Anti-Kalk-System 	<ul style="list-style-type: none"> ■ full metal body ■ with ball joint ■ with anticalcareous system 	260,-	619,-	824,-	895,-	1.268,-
			F	G	H	I	L
			1.085,-	821,-	1.098,-	1.389,-	2.189,-
649.20.280 Steigrohr, Umstellung, Wandarm	Supply pipe, diverter, wall bracket	A	B	C	D	E	
<ul style="list-style-type: none"> ■ zum Anschluß an die Brausebatterie ■ Ausladung 360-380 mm ■ in der Neigung und Höhe verstellbare Brausehalterung 	<ul style="list-style-type: none"> ■ to connect the exposed shower mixer ■ projection 360-380 mm ■ fitting for handshower adjustable in height and inclination 	589,-	932,-	1.198,-	1.362,-	1.741,-	
		F	G	H	I	L	
		1.599,-	1.318,-	1.649,-	1.895,-	2.529,-	
600.13.700 Brausegarnitur	Shower combination	A	B	C	D	E	
<ul style="list-style-type: none"> ■ Metall-Handbrause mit Anti-Kalk-System und Rückflussverhinderer ■ Brauseschlauch 1.500 mm, beidseitig mit drehbarem Konus 	<ul style="list-style-type: none"> ■ metal hand shower with anticalc. system and backflow preventer ■ metal shower hose 1.500 mm, both sides with turning cone 	369,-	449,-	551,-	608,-	750,-	
		F	G	H	I	L	
		695,-	734,-	1.019,-	844,-	1.499,-	
600.20.210 Aufputz-Brausebatterie ½"	Exposed shower mixer ½"	A	B	C	D	E	
<ul style="list-style-type: none"> ■ für Steigrohr ■ Brauseabgang ¾" ■ 2 keramische Oberteile ½" ■ verdeckte S-Anschlüsse ½" x ¾" 	<ul style="list-style-type: none"> ■ for supply pipe ■ discharge ¾" ■ 2 ceramic internal upper parts ½" ■ concealed S-connections ½" x ¾" 	646,-	787,-	968,-	1.090,-	1.284,-	
		F	G	H	I	L	
		1.194,-	945,-	1.164,-	1.423,-	2.160,-	

600.20.460 – Aufputz Set mit Steigrohr | Exposed set with shower system

	649.13.920 Regenbrause ½", ø 200 mm	Rain shower head ½", ø 200 mm	A	B	C	D	E
	<ul style="list-style-type: none"> ■ Ausführung ganz in Metall ■ mit Kugelgelenk ■ Anti-Kalk-System 	<ul style="list-style-type: none"> ■ full metal body ■ with ball joint ■ with anticalcareous system 	260,-	619,-	824,-	895,-	1.268,-
			F	G	H	I	L
			1.085,-	821,-	1.098,-	1.389,-	2.189,-
649.20.280 Steigrohr, Umstellung, Wandarm	Supply pipe, diverter, wall bracket	A	B	C	D	E	
<ul style="list-style-type: none"> ■ zum Anschluß an die Brausebatterie ■ Ausladung 360-380 mm ■ in der Neigung und Höhe verstellbare Brausehalterung 	<ul style="list-style-type: none"> ■ to connect the exposed shower mixer ■ projection 360-380 mm ■ fitting for handshower adjustable in height and inclination 	589,-	932,-	1.198,-	1.362,-	1.741,-	
		F	G	H	I	L	
		1.599,-	1.318,-	1.649,-	1.895,-	2.529,-	
600.13.700 Brausegarnitur	Shower combination	A	B	C	D	E	
<ul style="list-style-type: none"> ■ Metall-Handbrause mit Anti-Kalk-System und Rückflussverhinderer ■ Brauseschlauch 1.500 mm, beidseitig mit drehbarem Konus 	<ul style="list-style-type: none"> ■ metal hand shower with anticalc. system and backflow preventer ■ metal shower hose 1.500 mm, both sides with turning cone 	369,-	449,-	551,-	608,-	750,-	
		F	G	H	I	L	
		695,-	734,-	1.019,-	844,-	1.499,-	
600.20.260 Aufputz-Brausethermostat ½"	Exposed shower thermostat ½"	A	B	C	D	E	
<ul style="list-style-type: none"> ■ für Steigrohr ■ Brauseabgang ¾" ■ Dehnstoff-Thermoelement ■ Sicherheitssperre bei 38° C ■ Keramik-Innenoberteil ½" 	<ul style="list-style-type: none"> ■ for supply pipe ■ discharge ¾" ■ cartridge with thermoelement ■ heat scale, locking device at 38 °C ■ ceramic cartridge ½" 	1.179,-	1.586,-	1.754,-	1.877,-	2.519,-	
		F	G	H	I	L	
		2.259,-	1.845,-	2.265,-	2.819,-	3.311,-	

FLORALE CRYSTAL

Maßzeichnungen unter www.joerger.de - Menü SERVICE.
 Technical specifications under www.joerger.de - menu SERVICE.

A chrom chrome	[.000]	E platin matt platinum matt	[.066]
B silbernickel polished nickel	[.035]	F nerz matt milk matt	[.096]
C nerz milk	[.095]	G schwarz-matt black matt	[.092]
C nickel matt satin nickel	[.036]	G weiß-matt white matt	[.052]
D edelmessing sunshine	[.040]	H bronze bronze	[.011]
D platin platinum	[.065]	I gold gold	[.020]
E edelmess.matt sunshine matt	[.041]	L roségold rosegold	[.022]
E gold matt gold matt	[.021]	L roségold matt rosegold matt	[.023]

- 11 kristallklar | clear as crystal
- 12 schwarz | black
- 16 bernstein | amber
- 17 amethyst | amethyst

Die Artikelnummer wird um weitere 2 Ziffern erweitert. Beispiel:
 Waschtisch 3-Loch Batterie in chrom mit Griffen in kristallklar:

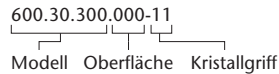

The article number needs to be added by 2 additional figures. For example:
 washbasin 3-hole mixer in chrome with handles in clear as crystal:

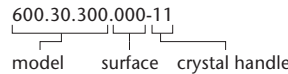

Unterputz-Thermostate 1/2" | Wall thermostats, concealed 1/2"



600.40.380 Unterputz-Thermostat 1/2" mit Mengenregulierung, Fertigmontageset

- manuelle, keramische Umstellung Wanne/Brause, druckunabhängig
- mit Sicherheitseinrichtung
- Durchflussrate 20,4 l/min bei 3 bar

Concealed wall thermostat 1/2" with flow control, assembly set

- manual, ceramic diverter tub/shower for pressure-independent function
- with safety device
- flow rate 20,4 l/min at 3 bar

A	B	C	D	E
1.175,-	1.306,-	1.594,-	1.673,-	1.972,-
F	G	H	I	L
1.842,-	1.594,-	1.861,-	2.045,-	2.499,-

Variante | Alternative



600.40.360 Unterputz-Thermostat 1/2" mit Mengenregulierung, Fertigmontageset

- ohne Umstellung
- mit integrierter keramischer Mengenregulierung
- Durchflussrate 20,4 l/min bei 3 bar

Concealed wall thermostat 1/2" with flow control, assembly set

- without diverter
- with integrated ceramic cartridge for volume control
- flow rate 20,4 l/min at 3 bar

A	B	C	D	E
1.154,-	1.294,-	1.560,-	1.652,-	1.951,-
F	G	H	I	L
1.821,-	1.573,-	1.826,-	2.024,-	2.490,-

Benötigt | Required



649.40.360 Unterputz-Einbaubox 1/2"

- zu Fertigmontageset 600.40.360, 600.40.380
- für Nass- und Trockenbau geeignet

Concealed wall box 1/2"

- for assembly set 600.40.360, 600.40.380
- for wetwall and drywall construction

A	B	C	D	E
168,-				

Unterputz-Thermostat 3/4" | Wall thermostat, concealed 3/4"



600.40.560 Unterputz-Thermostat 3/4" ohne Mengenregulierung, Fertigmontageset

- serienbezogener Temperiergriff
- Sicherheitssperre bei 38° C

Concealed wall thermostat 3/4" without flow control, assembly set

- design handle for temp. control
- locking device at 38° C

A	B	C	D	E
629,-	764,-	992,-	1.136,-	1.486,-
F	G	H	I	L
1.411,-	1.066,-	1.369,-	1.632,-	1.994,-

Benötigt | Required



649.40.555 Unterputz-Einbaukörper 3/4"

- zu Fertigmontageset 600.40.555
- Kartusche mit Schmutzfangsieben
- für Nass- und Trockenbau geeignet
- Durchflussrate 64,2 l/min bei 3 bar
- ohne Absperrung

Concealed thermostat body 3/4"

- for assembly set 600.40.555
- cartridge with filter screens
- for wetwall and drywall construction
- flow rate 64,2 l/min at 3 bar
- without shut-off

A	B	C	D	E
1.636,-				

Unterputz-Thermostat 3/4" | Wall thermostat, concealed 3/4"



600.40.520 Unterputz-Thermostat 3/4" ohne Mengenregulierung, Fertigmontageset

- serienbezogener Temperiergriff
- Sicherheitssperre bei 38° C

Concealed wall thermostat 3/4" without flow control, assembly set

- design handle for temp. control
- locking device at 38° C

A	B	C	D	E
629,-	764,-	992,-	1.136,-	1.486,-
F	G	H	I	L
1.411,-	1.066,-	1.369,-	1.632,-	1.994,-

Benötigt | Required



649.40.520 Unterputz-Einbaukörper 3/4"

- zu Fertigmontageset 600.40.520
- Kartusche mit Schmutzfangsieben
- für Nass- und Trockenbau geeignet
- Durchflussrate 41 l/min bei 3 bar
- ohne Absperrung

Concealed thermostat body 3/4"

- for assembly set 600.40.520
- cartridge with filter screens
- for wetwall and drywall construction
- flow rate 41 l/min at 3 bar
- without shut-off

A	B	C	D	E
498,-				

FLORALE CRYSTAL

Maßzeichnungen unter www.joerg.de - Menü SERVICE.
 Technical specifications under www.joerg.de - menu SERVICE.

A chrom chrome	[.000]	E platin matt platinum matt	[.066]
B silbernickel polished nickel	[.035]	F nerz matt milk matt	[.096]
C nerz milk	[.095]	G schwarz-matt black matt	[.092]
C nickel matt satin nickel	[.036]	G weiß-matt white matt	[.052]
D edelmessing sunshine	[.040]	H bronze bronze	[.011]
D platin platinum	[.065]	I gold gold	[.020]
E edelmess.matt sunshine matt	[.041]	L roségold rosegold	[.022]
E gold matt gold matt	[.021]	L roségold matt rosegold matt	[.023]

- 11 kristallklar | clear as crystal
- 12 schwarz | black
- 16 bernstein | amber
- 17 amethyst | amethyst

Die Artikelnummer wird um weitere 2 Ziffern erweitert. Beispiel:
 Waschtisch 3-Loch Batterie in chrom mit Griffen in kristallklar:

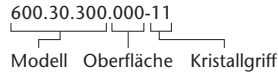

The article number needs to be added by 2 additional figures. For example:
 washbasin 3-hole mixer in chrome with handles in clear as crystal:

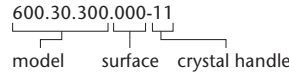

Unterputz-Thermostat/Ventil-Modul | Concealed thermostatic/wall-valve modul



600.60.432 Unterputz-Ventil-Modul
 Fertigmontageset

- Kristallgriff
- Rosette

Concealed wall-valve-modul
 assembly set

- crystal handle
- escutcheon

A	B	C	D	E
284,-	315,-	344,-	372,-	439,-
F	G	H	I	L
418,-	339,-	432,-	568,-	822,-

Benötigt | Required



649.20.610 Unterputz-Ventil-Modul, 1-fach

- 1x Spindelventil 3/4", rechtsschließend mit keram. Scheiben
- 2 Abgänge 1/2", je 1x rechts/links möglich, gleichzeitig benutzbar

Concealed wall-valve-modul, single

- 1x spindle valve 3/4", clockwise closure with ceramic discs
- 2 outlets 1/2", each 1x right/left possible, simultaneously usable

A	B	C	D	E
229,-				



649.20.620 Unterputz-Ventil-Modul, 2-fach

- 2x Spindelventil 3/4", rechtsschließend mit keram. Scheiben
- 4 Abgänge 1/2", je 2x rechts/links möglich, gleichzeitig benutzbar
- im Verbund maßgenaue Montage
- erweiterbar mit 649.20.610

Concealed wall-valve-modul, double

- 2x spindle valve 3/4", clockwise closure with ceramic discs
- 4 outlets 1/2", each 2x right/left possible, simultaneously usable
- precise assembly due to composite
- expandable with 649.20.610

A	B	C	D	E
458,-				



649.20.630 Unterputz-Ventil-Modul, 3-fach

- 3x Spindelventil 3/4", rechtsschließend mit keram. Scheiben
- 6 Abgänge 1/2", je 3x rechts/links möglich, gleichzeitig benutzbar
- im Verbund maßgenauen Montage
- erweiterbar mit 649.20.610

Concealed wall-valve-modul, triple

- 3x spindle valve 3/4", clockwise closure with ceramic discs
- 6 outlets 1/2", each 3x right/left possible, simultaneously usable
- precise assembly due to composite
- expandable with 649.20.610

A	B	C	D	E
686,-				



637.40.460 Unterputz-Thermostat 1/2"
ohne Mengenregulierung,
 Fertigmontageset

- Funktionseinheit ohne Umstellung und ohne Absperrung
- Durchflussrate 25,8 l/min bei 3 bar

Concealed wall thermostat 1/2"
without flow control,
 assembly set

- Functional unit without diverter and without shut-off
- flow rate 25,8 l/min at 3 bar

A	B	C	D	E
884,-	1.038,-	1.220,-	1.279,-	1.539,-
F	G	H	I	L
1.382,-	1.196,-	1.462,-	1.710,-	2.018,-

Benötigt | Required

649.20.612 Anschlußadapter 1/2"

- Anschlußadapter, Abschlußstopfen
- passend zu Einbaubox 649.40.360

Connection adapter 1/2"

- connection adapter, end plug
- matching to wall box 649.40.360

A	B	C	D	E
122,-				



649.40.360 Unterputz-Einbaubox 1/2"

- zu Fertigmontageset 600.40.460
- für Nass- und Trockenbau geeignet

Concealed wall box 1/2"

- for assembly set 600.40.460
- for wetwall and drywall construction

A	B	C	D	E
168,-				

FLORALE CRYSTAL

Maßzeichnungen unter www.joerger.de - Menü SERVICE.
 Technical specifications under www.joerger.de - menu SERVICE.

A chrom chrome	[.000]	E platin matt platinum matt	[.066]
B silbernickel polished nickel	[.035]	F nerz matt milk matt	[.096]
C nerz milk	[.095]	G schwarz-matt black matt	[.092]
C nickel matt satin nickel	[.036]	G weiß-matt white matt	[.052]
D edelmessing sunshine	[.040]	H bronze bronze	[.011]
D platin platinum	[.065]	I gold gold	[.020]
E edelmess.matt sunshine matt	[.041]	L roségold rosegold	[.022]
E gold matt gold matt	[.021]	L roségold matt rosegold matt	[.023]

- 11 kristallklar | clear as crystal
- 12 schwarz | black
- 16 bernstein | amber
- 17 amethyst | amethyst

Die Artikelnummer wird um weitere 2 Ziffern erweitert. Beispiel:
 Waschtisch 3-Loch Batterie in chrom mit Griffen in kristallklar:

600.30.300.000-11
 Modell Oberfläche Kristallgriff

The article number needs to be added by 2 additional figures. For example:
 washbasin 3-hole mixer in chrome with handles in clear as crystal:

600.30.300.000-11
 model surface crystal handle



600.40.560 Unterputz-Thermostat ¾" ohne Mengenregulierung, Fertigmontageset
 ■ serienbezogener Temperiergriff
 ■ Sicherheitssperre bei 38° C

Concealed wall thermostat ¾" without flow control, assembly set
 ■ design handle for temp. control
 ■ locking device at 38° C

A	B	C	D	E
629,-	764,-	992,-	1.136,-	1.486,-
F	G	H	I	L
1.411,-	1.066,-	1.369,-	1.632,-	1.994,-

Benötigt | Required



649.20.634 Anschlußadapter ¾"
 ■ Anschlußadapter, Abschlußstopfen
 ■ passend zu Einbaukörper 649.40.555

Connection adapter ¾"
 ■ connection adapter, end plug
 ■ matching to wall body 649.40.555

A	B	C	D	E
146,-				



649.40.555 Unterputz-Einbaukörper ¾"
 ■ zu Fertigmontageset 600.40.555
 ■ Kartusche mit Schmutzfangsieben
 ■ für Nass- und Trockenbau geeignet
 ■ Durchflussrate 64,2 l/min bei 3 bar
 ■ ohne Absperrung

Concealed thermostat body ¾"
 ■ for assembly set 600.40.555
 ■ cartridge with filter screens
 ■ for wetwall and drywall construction
 ■ flow rate 64,2 l/min at 3 bar
 ■ without shut-off

A	B	C	D	E
1.636,-				

Unterputz-Umstellung und Ventile | Diverter and valves concealed



600.40.650 Unterputz 3-Wege Umstellung ½" Fertigmontageset
 ■ Kristallgriff
 ■ Hülse, Schubrosette

Concealed 3-position diverter ½" assembly set
 ■ crystal handle
 ■ socket with adjustable escutcheon

A	B	C	D	E
294,-	336,-	376,-	406,-	483,-
F	G	H	I	L
466,-	346,-	438,-	605,-	829,-

Benötigt | Required



649.40.600 Unterputz 3-Wege Umstellung ½" Einbaukörper
 ■ zu Fertigmontageset 600.40.650

Concealed 3-position diverter ½" diverter body
 ■ for assembly set 600.40.650

A	B	C	D	E
236,-				



600.50.234 Unterputz-Ventil Fertigmontageset
 ■ Kristallgriff
 ■ Hülse, Schubrosette

Concealed wall valve assembly set
 ■ crystal handle
 ■ socket with adjustable escutcheon

A	B	C	D	E
264,-	299,-	338,-	366,-	435,-
F	G	H	I	L
419,-	311,-	398,-	542,-	746,-

Benötigt | Required



649.20.340 Unterputz-Ventil ½", Einbaukörper
 ■ rechtsschließend, ker. Scheiben

Concealed wall valve ½", body
 ■ clockwise closure, ceramic discs

A	B	C	D	E
62,-				



649.20.345 Unterputz-Ventil ½", Einbaukörper
 ■ linksschließend, ker. Scheiben

Concealed wall valve ½", body
 ■ counter-clockwise closure, cer. discs

649.20.440 Unterputz-Ventil ¾", Einbaukörper
 ■ rechtsschließend, ker. Scheiben

Concealed wall valve ¾", body
 ■ clockwise closure, ceramic discs

A	B	C	D	E
106,-				

649.20.445 Unterputz-Ventil ¾", Einbaukörper
 ■ linksschließend, ker. Scheiben

Concealed wall valve ¾", body
 ■ counter-clockwise closure, cer. discs

FLORALE CRYSTAL

Maßzeichnungen unter www.joerg.de - Menü SERVICE.
 Technical specifications under www.joerg.de - menu SERVICE.

A chrom chrome	[.000]	E platin matt platinum matt	[.066]
B silbernickel polished nickel	[.035]	F nerz matt milk matt	[.096]
C nerz milk	[.095]	G schwarz-matt black matt	[.092]
C nickel matt satin nickel	[.036]	G weiß-matt white matt	[.052]
D edelmessing sunshine	[.040]	H bronze bronze	[.011]
D platin platinum	[.065]	I gold gold	[.020]
E edelmess.matt sunshine matt	[.041]	L roségold rosegold	[.022]
E gold matt gold matt	[.021]	L roségold matt rosegold matt	[.023]

- 11 kristallklar | clear as crystal
- 12 schwarz | black
- 16 bernstein | amber
- 17 amethyst | amethyst









Die Artikelnummer wird um weitere 2 Ziffern erweitert. Beispiel:
 Waschtisch 3-Loch Batterie in chrom mit Griffen in kristallklar:

600.30.300.000-11
 Modell Oberfläche Kristallgriff

The article number needs to be added by 2 additional figures. For example:
 washbasin 3-hole mixer in chrome with handles in clear as crystal:

600.30.300.000-11
 model surface crystal handle

Brausen | Showers

	600.13.310	Duschgarnitur, komplett <ul style="list-style-type: none"> ■ Wandrohr 780 mm, mit Schieber ■ Metall-Handbrause mit Anti-Kalk-System und Rückflussverhinderer ■ Metall-Brauseschlauch 1750 mm, beidseitig mit drehbarem Konus 	Shower bar set, complete <ul style="list-style-type: none"> ■ wall bar 780 mm, with slider ■ metal hand shower with anticalc. system and backflow preventer ■ metal shower hose 1750 mm, both sides with turning cone 	A	B	C	D	E
				1.246,-	1.605,-	1.902,-	2.140,-	2.521,-
				F	G	H	I	L
			2.260,-	1.856,-	2.199,-	2.770,-	3.529,-	
	600.13.350	Duschstange, lose <ul style="list-style-type: none"> ■ Wandrohr 780 mm, mit Schieber 	Shower bar, separate <ul style="list-style-type: none"> ■ wall bar 780 mm, with slider 	A	B	C	D	E
				874,-	1.019,-	1.126,-	1.266,-	1.492,-
				F	G	H	I	L
			1.356,-	1.099,-	1.189,-	1.682,-	2.247,-	
	600.13.200	Schlauchbrausegarnitur <ul style="list-style-type: none"> ■ Wandanschlußbogen 1/2" ■ Wand-Brausehalter ■ Metall-Handbrause mit Anti-Kalk-System und Rückflussverhinderer ■ Metall-Brauseschlauch 1500 mm, beidseitig mit drehbarem Konus 	Shower combination <ul style="list-style-type: none"> ■ Wall elbow connection 1/2" ■ Wall fitting for hand shower ■ metal hand shower with anticalc. system and backflow preventer ■ flexible metal shower hose 1500 mm, both sides with turning cone 	A	B	C	D	E
				592,-	727,-	809,-	910,-	1.072,-
				F	G	H	I	L
			946,-	948,-	1.259,-	1.139,-	1.784,-	
	600.13.150	Wandanschlußbogen 1/2", ohne Haken <ul style="list-style-type: none"> ■ Brauseabgang 1/2" ■ mit Rückflussverhinderer, Rosette 	Wall elbow connection 1/2", without cradle <ul style="list-style-type: none"> ■ discharge 1/2" ■ with backflow preventer, escutcheon 	A	B	C	D	E
				99,-	134,-	139,-	157,-	185,-
				F	G	H	I	L
			169,-	158,-	198,-	208,-	314,-	
	649.13.210	Wand-Brausehalter	Wall fitting for hand shower	A	B	C	D	E
				178,-	214,-	266,-	287,-	337,-
				F	G	H	I	L
			299,-	256,-	325,-	374,-	459,-	
	600.13.237	Hygienebrausegarnitur <ul style="list-style-type: none"> ■ Wandbrausehalter und -anschlußbogen 1/2", Schubrosette ■ Hygienebrause, klassisch (649.13.338), komplett aus Metall ■ einstrahlig, Bedienung über Druckhebel ■ Metall-Brauseschlauch 1250 mm 	Ablution spray combination <ul style="list-style-type: none"> ■ wall fitting and elbow connection 1/2" ■ spray handshower, classical (649.13.338), completely metal ■ one jet, push-lever operation ■ flexible metal shower hose 1250 mm 	A	B	C	D	E
				332,-	404,-	645,-	676,-	893,-
				F	G	H	I	L
			772,-	669,-	998,-	1.081,-	1.529,-	
	605.20.237	1-Hand Batterie 1/2" für Hygiene-Brause, Fertigmontageset <ul style="list-style-type: none"> ■ Rosette, Griff ■ mit Kristallgriff 	Concealed single lever 1/2" for ablution spray, assembly set <ul style="list-style-type: none"> ■ escutcheon, handle ■ with crystal handle 	A	C	D	E	F
				319,-	434,-	529,-	595,-	699,-
				G	H	I	K	L
			648,-	556,-	632,-	775,-	839,-	
	649.20.237	Unterputz 1-Hand Batterie 1/2", Einbaukörper <ul style="list-style-type: none"> ■ Kartusche mit keramischen Scheiben ■ zu Fertigmontageset 605.20.237 	Single lever mixer 1/2", concealed body <ul style="list-style-type: none"> ■ cartridge with ceramic discs ■ for assembly set 605.20.237 	A	C	D	E	F
				125,-	169,-	208,-	229,-	268,-
				G	H	I	K	L
			249,-	224,-	258,-	329,-	396,-	

Benötigt | Required

FLORALE CRYSTAL

Maßzeichnungen unter www.joerger.de - Menü SERVICE.
 Technical specifications under www.joerger.de - menu SERVICE.

A chrom chrome	[.000]	E platin matt platinum matt	[.066]
B silbernickel polished nickel	[.035]	F nerz matt milk matt	[.096]
C nerz milk	[.095]	G schwarz-matt black matt	[.092]
C nickel matt satin nickel	[.036]	G weiß-matt white matt	[.052]
D edelmessing sunshine	[.040]	H bronze bronze	[.011]
D platin platinum	[.065]	I gold gold	[.020]
E edelmess.matt sunshine matt	[.041]	L roségold rosegold	[.022]
E gold matt gold matt	[.021]	L roségold matt rosegold matt	[.023]

- 11 kristallklar | clear as crystal
- 12 schwarz | black
- 16 bernstein | amber
- 17 amethyst | amethyst

Die Artikelnummer wird um weitere 2 Ziffern erweitert. Beispiel: Waschtisch 3-Loch Batterie in chrom mit Griffen in kristallklar:

600.30.300.000-11
 Modell Oberfläche Kristallgriff

The article number needs to be added by 2 additional figures. For example: washbasin 3-hole mixer in chrome with handles in clear as crystal:

600.30.300.000-11
 model surface crystal handle

	649.13.615 Stachelkopfbrause ½“ ■ ø 230 mm, 75 Düsen ■ Ausführung ganz in Metall ■ Anti-Kalk-System ■ Brausekopf schwenkbar ■ <u>ohne Wandarm</u> ■ weitere, zur Serie passende Kopfbrausen siehe Kapitel "Brausen"	Body spray shower head ½“ ■ ø 230 mm, 75 jets ■ full metal body ■ anticalcareous system ■ swivel shower head ■ <u>without wall bracket</u> ■ for further shower heads matching this collection see chapter "showers"	A	B	C	D	E
			969,-	1.232,-	1.359,-	1.416,-	1.659,-
			F	G	H	I	L
			1.496,-	1.399,-	1.718,-	2.262,-	2.739,-

Empfohlen | Recommended

	649.13.625 Wandarm ½“ ■ Ausladung 162 mm ■ weitere, zur Serie passende Wandarme siehe Kapitel "Brausen"	Wall bracket ½“ ■ projection 162 mm ■ for further wall brackets matching this collection see chapter "showers"	A	B	C	D	E
			126,-	145,-	171,-	189,-	250,-
			F	G	H	I	L
			229,-	192,-	296,-	286,-	499,-

	649.13.519 Seitenbrause ½“ ■ Rosette ø 130 mm, Wandmontage ■ Brausekopf schwenkbar, 20° ■ Anti-Kalk-System ■ Ausführung Kunststoff ■ weitere, zur Serie passende Seitenbrausen siehe Kapitel "Brausen"	Body spray side shower ½“ ■ escutcheon ø 130 mm, wall assembly ■ swivel shower head, 20° ■ anticalcareous system ■ plastic ■ for further side showers matching this collection see chapter "showers"	A	B	C	D	E
			167,-	326,-	385,-	399,-	542,-
			F	G	H	I	L
			496,-	376,-	472,-	634,-	949,-

Accessoires für Handtücher | Accessories for towels

	600.00.002 Handtuchhalter, doppelt ■ Rohre schwenkbar, ca. 430 mm	Double towel bar ■ swivelling bars, approx. 430 mm	A	B	C	D	E
			479,-	635,-	705,-	790,-	958,-
	600.00.012 Handtuchhalter, doppelt ■ verkürzt, ca. 300 mm	Double towle bar ■ shortened, approx. 300 mm	F	G	H	I	L
			832,-	688,-	784,-	1.117,-	1.268,-

	600.00.047 Handtuchring ■ ø ca. 190 mm ■ geschlossene Ausführung	Towel ring ■ ø approx. 190 mm ■ closed version	A	B	C	D	E
			385,-	467,-	515,-	565,-	678,-
			F	G	H	I	L
			599,-	506,-	574,-	756,-	929,-

FLORALE CRYSTAL

A chrom chrome	[.000]	E platin matt platinum matt	[.066]
B silbernickel polished nickel	[.035]	F nerz matt milk matt	[.096]
C nerz milk	[.095]	G schwarz-matt black matt	[.092]
C nickel matt satin nickel	[.036]	G weiß-matt white matt	[.052]
D edelmessing sunshine	[.040]	H bronze bronze	[.011]
D platin platinum	[.065]	I gold gold	[.020]
E edelmess.matt sunshine matt	[.041]	L roségold rosegold	[.022]
E gold matt gold matt	[.021]	L roségold matt rosegold matt	[.023]

Maßzeichnungen unter www.joerger.de - Menü SERVICE.
 Technical specifications under www.joerger.de - menu SERVICE.

- 11 kristallklar | clear as crystal
- 12 schwarz | black
- 16 bernstein | amber
- 17 amethyst | amethyst

Die Artikelnummer wird um weitere 2 Ziffern erweitert. Beispiel:
 Waschtisch 3-Loch Batterie in chrom mit Griffen in kristallklar:

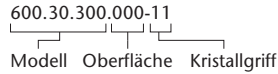

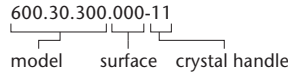

The article number needs to be added by 2 additional figures. For example:
 washbasin 3-hole mixer in chrome with handles in clear as crystal:



	600.00.022 Handtuchhaken	Robe hanger	A	B	C	D	E
			259,-	334,-	391,-	435,-	525,-
			F	G	H	I	L
			476,-	382,-	472,-	603,-	765,-

	600.00.040 Badetuchhalter ■ ca. 800 mm	Bath towel bar ■ approx. 800 mm	A	B	C	D	E
			689,-	797,-	867,-	967,-	1.125,-
			F	G	H	I	L
			1.074,-	866,-	1.108,-	1.249,-	1.919,-

	600.00.031 Wannengriff ■ ca. 300 mm	Tub handle ■ approx. 300 mm	A	B	C	D	E
			619,-	709,-	773,-	864,-	1.004,-
			F	G	H	I	L
			946,-	755,-	874,-	1.055,-	1.328,-

	600.00.104 Gästehandtuchkorb, eckig ■ mit Ablage ■ Korbgröße 260 x 150 x 190 mm	Guest towel basket, angular ■ with shelf ■ basket size 260 x 150 x 190 mm	A	B	C	D	E
			443,-	505,-	626,-	701,-	817,-
			F	G	H	I	L
			764,-	611,-	1.008,-	889,-	1.915,-

Accessoires für Seife | Accessories for soap

	600.00.007 Seifenhalter, komplett ■ Seifenschale aus Kristallglas	Soap dish holder, complete ■ crystal glass dish	A	B	C	D	E
			373,-	506,-	566,-	634,-	761,-
			F	G	H	I	L
			705,-	553,-	496,-	875,-	939,-

700.00.307 Seifenschale, lose	Glass dish, separate	A				
		99,-				

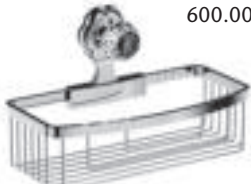
	600.00.105 Schwammkorb ■ rechteckig, 260 x 130 mm	Sponge basket ■ rectangular, 260 x 130 mm	A	B	C	D	E
			394,-	484,-	530,-	594,-	714,-
			F	G	H	I	L
			652,-	582,-	768,-	822,-	1.279,-

FLORALE CRYSTAL

Maßzeichnungen unter www.joerger.de - Menü SERVICE.
 Technical specifications under www.joerger.de - menu SERVICE.

A chrom chrome	[.000]	E platin matt platinum matt	[.066]
B silbernickel polished nickel	[.035]	F nerz matt milk matt	[.096]
C nerz milk	[.095]	G schwarz-matt black matt	[.092]
C nickel matt satin nickel	[.036]	G weiß-matt white matt	[.052]
D edelmessing sunshine	[.040]	H bronze bronze	[.011]
D platin platinum	[.065]	I gold gold	[.020]
E edelmess.matt sunshine matt	[.041]	L roségold rosegold	[.022]
E gold matt gold matt	[.021]	L roségold matt rosegold matt	[.023]

- 11 kristallklar | clear as crystal
- 12 schwarz | black
- 16 bernstein | amber
- 17 amethyst | amethyst

Die Artikelnummer wird um weitere 2 Ziffern erweitert. Beispiel: Waschtisch 3-Loch Batterie in chrom mit Griffen in kristallklar:

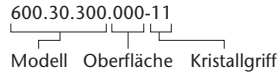

The article number needs to be added by 2 additional figures. For example: washbasin 3-hole mixer in chrome with handles in clear as crystal:

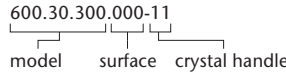

600.00.106 Eckschwammkorb
 ■ 195 x 195 mm

Corner sponge basket
 ■ 195 x 195 mm

A	B	C	D	E
389,-	432,-	486,-	543,-	650,-
F	G	H	I	L
572,-	578,-	692,-	748,-	1.186,-



600.00.006 Lotionsspender, komplett

Soap dispenser, complete

A	B	C	D	E
478,-	534,-	571,-	640,-	769,-
F	G	H	I	L
712,-	565,-	628,-	885,-	958,-

713.00.306 Lotionsspenderglas, lose
 ■ seidenmatt, ohne Pumpe

Soap dispenser glass, separate
 ■ frosted, without pump

A	B	C	D	E
78,-				

Accessoires für Waschplatz | Accessories for washstands



600.00.036 Glshalter, komplett
 ■ Glas aus Kristallglas

Tumbler holder, complete
 ■ crystal glass tumbler

A	B	C	D	E
398,-	504,-	562,-	630,-	756,-
F	G	H	I	L
692,-	549,-	569,-	871,-	968,-

700.00.336 Mundglas, lose

Glass tumbler, separate

A	B	C	D	E
96,-				



600.00.009 Ablage, 600 mm
 ■ Glasplatte aus Kristallglas

Shelf holder with glass, 600 mm
 ■ crystal glass shelf

A	B	C	D	E
652,-	738,-	769,-	858,-	998,-
F	G	H	I	L
925,-	752,-	828,-	1.152,-	1.229,-

Accessoires für WC-Bereich | Accessories for w.c. area



600.00.014 Papierhalter
 ■ mit Deckel

Toilet paper roll holder
 ■ with lid

A	B	C	D	E
434,-	500,-	675,-	755,-	917,-
F	G	H	I	L
812,-	659,-	689,-	1.066,-	1.178,-



600.00.015 Reserve-Papierhalter

Spare toilet paper roll holder

A	B	C	D	E
340,-	437,-	513,-	574,-	687,-
F	G	H	I	L
614,-	499,-	428,-	791,-	879,-

FLORALE CRYSTAL

Maßzeichnungen unter www.joerger.de - Menü SERVICE.
 Technical specifications under www.joerger.de - menu SERVICE.

A chrom chrome	[.000]	E platin matt platinum matt	[.066]
B silbernickel polished nickel	[.035]	F nerz matt milk matt	[.096]
C nerz milk	[.095]	G schwarz-matt black matt	[.092]
C nickel matt satin nickel	[.036]	G weiß-matt white matt	[.052]
D edelmessing sunshine	[.040]	H bronze bronze	[.011]
D platin platinum	[.065]	I gold gold	[.020]
E edelmess.matt sunshine matt	[.041]	L roségold rosegold	[.022]
E gold matt gold matt	[.021]	L roségold matt rosegold matt	[.023]

- 11 kristallklar | clear as crystal
- 12 schwarz | black
- 16 bernstein | amber
- 17 amethyst | amethyst

Die Artikelnummer wird um weitere 2 Ziffern erweitert. Beispiel:
 Waschtisch 3-Loch Batterie in chrom mit Griffen in kristallklar:

600.30.300.000-11
 Modell Oberfläche Kristallgriff

The article number needs to be added by 2 additional figures. For example:
 washbasin 3-hole mixer in chrome with handles in clear as crystal:

600.30.300.000-11
 model surface crystal handle



600.00.000 Klosettbürstengarnitur, komplett ■ Glas aus Kristallglas, seidenmatt	Toilet brush holder set, complete ■ crystal glass, frosted	A	B	C	D	E
		648,-	699,-	740,-	795,-	929,-
		F	G	H	I	L
		864,-	784,-	982,-	1.059,-	1.319,-
<hr/>						
799.00.300 Bürstenglas, seidenmatt, lose	Brush glass, frosted, separate	A				
		48,-				
<hr/>						
650.00.053 Bürstenstange komplett, lose	Brush rod with brush, separate	A	B	C	D	E
		139,-	189,-	215,-	242,-	296,-
		F	G	H	I	L
		269,-	179,-	224,-	349,-	476,-
<hr/>						
799.00.238 Bürstenkopf, lose	Brush, separate	A				
		19,-				

Leuchten und Spiegel | Lamps and mirrors



600.00.061 Wandleuchte, komplett ■ mit Leuchtmittel, 40 W	Wall lamp, complete ■ light bulb included, 40 W	A	B	C	D	E
		778,-	848,-	904,-	996,-	1.198,-
		F	G	H	I	L
		1.069,-	1.049,-	1.159,-	1.452,-	1.857,-
<hr/>						
700.00.361 Leuchtenglas, lose ■ Leuchtenglas klar	Glass, separate ■ glass clear	A				
		199,-				



649.00.414 Kosmetikspiegel, beleuchtet ■ schwenk- und ausziehbar ■ 3-fache Vergrößerung ■ Direktanschluss ■ Spiegeldurchmesser 185 mm ■ Rahmendurchmesser 250 mm ■ Kalt-, Warm- und Taglicht durch Piezzo-Schalter umschaltbar	Cosmetic mirror, incl. lighting ■ swivelling and extendable ■ magnification 3:1 ■ direct connection ■ mirror diameter 185 mm ■ frame diameter 250 mm ■ cold, warm and day light switchable by Piezzo switch	A	B	C	D	E
		556,-	988,-	1.214,-	1.418,-	1.828,-
		F	G	H	I	L
		1.684,-	1.214,-	1.549,-	2.138,-	2.998,-



RAINHEAVEN | BRAUSEN | SHOWERS



Oberflächen | colours

Folgende Oberflächen sind bei dieser Serie möglich |
The following colours are possible with this collection

chrom		chrome	[.000]	PG A
silbernickel		polished nickel	[.035]	PG B
nerz		mink	[.095]	PG C
nickel matt		satin nickel	[.036]	PG C
edelmessing		sunshine	[.040]	PG D
platin		platinum	[.065]	PG D
edelmessing matt		sunshine matt	[.041]	PG E
gold matt		gold matt	[.021]	PG E
platin matt		platinum matt	[.066]	PG E
nerz matt		mink matt	[.096]	PG F
schwarz matt		black matt	[.092]	PG G
weiß matt		white matt	[.052]	PG G
bronze		bronze	[.011]	PG H
gold		gold	[.020]	PG I
roségold		rosegold	[.022]	PG L
roségold matt		rosegold matt	[.023]	PG L

Andere Oberflächen auf Anfrage |
Different colours on request

Auf Anfrage können wir Produkte von Drittanbietern auch gerne passend zu unseren Oberflächen veredeln (vorbehaltlich der Eignungsprüfung) | Third-party products may be plated matching to our colours on request (subject to valuation of suitability)

Regenhimmel | Rainheaven

ab Seite | from page 228

Regenbrausen | Rain Showers

ab Seite | from page 230

Zubehör | Suplies

ab Seite | from page 232

Seitenbrausen | Sideshowers

ab Seite | from page 233

Handbrausen | Handshowers

ab Seite | from page 234

Hygienebrausen | Spray handshowers

ab Seite | from page 235

A chrom chrome	[.000]	E platin matt platinum matt	[.066]
B silbernickel polished nickel	[.035]	F nerz matt mink matt	[.096]
C nerz mink	[.095]	G schwarz-matt black matt	[.092]
C nickel matt satin nickel	[.036]	G weiß-matt white matt	[.052]
D edelmessing sunshine	[.040]	H bronze bronze	[.011]
D platin platinum	[.065]	I gold gold	[.020]
E edelmess.matt sunshine matt	[.041]	L roségold rosegold	[.022]
E gold matt gold matt	[.021]	L roségold matt rosegold matt	[.023]

Regenhimmel 610 x 610 | Rain heaven 610 x 610

- 605 Düsen mit Anti-Kalk-System
- 2 mm ultra-dünner Edelstahl
- Empfohlener Wasserfluss: über 20 l/min.
- anwählbar (über Unterputz-Modul-System): mittleres und/oder äußere Segmente
- montagefreundlich und wartbar
- zum Einbau an die Decke

- 605 jets with anticalcareous system
- 2 mm ultra-thin stainless steel
- recommended water flow above 20 l / min.
- selectable (via concealed Wall-valve module system): middle and/or external segments
- easy to mount and maintain
- ceiling built-in version

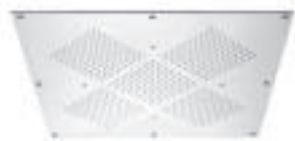
	649.14.640 Regenhimmel 610 x 610 mm <ul style="list-style-type: none"> ■ Strahlart: Regenstrahl, Zerstäuber (Nebel) ■ Strahlzonen: Körperzone - äußere Deckenbrausezone, Regenzone - innere Deckenbrausezone, Kompletzone, Zerstäuberzone ■ Ansteuerung der 3 Strahlzonen muss über 3 Ventile erfolgen 	Rain heaven 610 x 610 mm <ul style="list-style-type: none"> ■ jet types: rainfall, atomizer ■ jet zones: body zone - perimetral rain shower zone, rain zone - internal rain shower zone, complete zone, atomizer zone ■ control of the 3 jet zones must be carried out by 3 valves 	A	B	C	D	E
			3.755,-	4.799,-	5.848,-	6.282,-	7.884,-
			F	G	H	I	L
			7.239,-	5.615,-	7.672,-	8.568,-	10.478,-

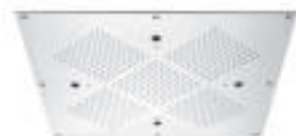
	649.14.650 Regenhimmel 610 x 610 mm <ul style="list-style-type: none"> ■ Strahlart: Regenstrahl ■ Strahlzonen: Körperzone - äußere Deckenbrausezone, Regenzone - innere Deckenbrausezone, Kompletzone ■ Ansteuerung der 2 Strahlzonen muss über 2 Ventile erfolgen 	Rain heaven 610 x 610 mm <ul style="list-style-type: none"> ■ jet types: rainfall ■ jet zones: body zone - perimetral rain shower zone, rain zone - internal rain shower zone, complete zone ■ control of the 2 jet zones must be carried out by 2 valves 	A	B	C	D	E
			3.232,-	4.279,-	5.324,-	5.758,-	7.359,-
			F	G	H	I	L
			6.717,-	5.855,-	7.892,-	8.044,-	9.955,-

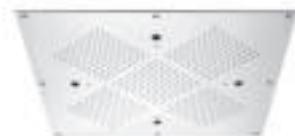
	649.14.645 Regenhimmel 610 x 610 mm <ul style="list-style-type: none"> ■ mit Chromotherapie (bitte Schalter hierzu separat bestellen: 649.14.745.xxx) ■ Spannungsversorgung LED: Eingangsspannung 85-260 Volt AC ■ Strahlart: Regenstrahl, Zerstäuber (Nebel) ■ Strahlzonen: Körperzone - äußere Deckenbrausezone, Regenzone - innere Deckenbrausezone, Kompletzone, Zerstäuberzone ■ Ansteuerung der 3 Strahlzonen muss über 3 Ventile erfolgen 	Rain heaven 610 x 610 mm <ul style="list-style-type: none"> ■ with chromotherapy (switch control not included; please order switch separate: 649.14.745.xxx) ■ power LED: input voltage 85-260 V AC ■ jet types: rainfall, atomizer ■ jet zones: body zone - perimetral rain shower zone, rain zone - internal rain shower zone, complete zone, atomizer zone ■ control of the 3 jet zones must be carried out by 3 valves 	A	B	C	D	E
			4.882,-	5.928,-	6.974,-	7.408,-	9.009,-
			F	G	H	I	L
			8.367,-	8.184,-	10.034,-	9.694,-	11.605,-

	649.14.655 Regenhimmel 610 x 610 mm <ul style="list-style-type: none"> ■ mit Chromotherapie (bitte Schalter hierzu separat bestellen: 649.14.745.xxx) ■ Strahlart: Regenstrahl ■ Strahlzonen: Körperzone - äußere Deckenbrausezone, Regenzone - innere Deckenbrausezone, Kompletzone ■ Ansteuerung der 2 Strahlzonen muss über 2 Ventile erfolgen 	Rain heaven 610 x 610 mm <ul style="list-style-type: none"> ■ with chromotherapy (switch control not included; please order switch separate: 649.14.745.xxx) ■ jet types: rainfall ■ jet zones: body zone - perimetral rain shower zone, rain zone - internal rain shower zone, complete zone ■ control of the 2 jet zones must be carried out by 2 valves 	A	B	C	D	E
			4.348,-	5.394,-	6.439,-	6.874,-	8.475,-
			F	G	H	I	L
			7.832,-	8.096,-	9.954,-	9.158,-	11.069,-

	649.14.745 Schalter für Chromotherapie <ul style="list-style-type: none"> ■ mit einem Knopf ■ bestehend aus Metall 	Switch control for chromotherapy <ul style="list-style-type: none"> ■ with 1 button ■ composed of brass plate 	A	B	C	D	E
			349,-	409,-	717,-	791,-	1.043,-
			F	G	H	I	L
			645,-	490,-	944,-	1.178,-	1.683,-

A chrom chrome	[.000]	E platin matt platinum matt	[.066]
B silbernickel polished nickel	[.035]	F nerz matt milk matt	[.096]
C nerz milk	[.095]	G schwarz-matt black matt	[.092]
C nickel matt satin nickel	[.036]	G weiß-matt white matt	[.052]
D edelmessing sunshine	[.040]	H bronze bronze	[.011]
D platin platinum	[.065]	I gold gold	[.020]
E edelmess.matt sunshine matt	[.041]	L roségold rosegold	[.022]
E gold matt gold matt	[.021]	L roségold matt rosegold matt	[.023]

Regenhimmel 700 x 500 | Rain heaven 700 x 500

- | | |
|---|---|
| <ul style="list-style-type: none"> ■ 484 Düsen mit Anti-Kalk-System ■ 2 mm ultra-dünner Edelstahl ■ Empfohlener Wasserfluss: über 20 l/min. ■ anwählbar (über Unterputz-Modul-System) ■ montagefreundlich und wartbar ■ zum Einbau an die Decke | <ul style="list-style-type: none"> ■ 484 jets with anticalcareous system ■ 2 mm ultra-thin stainless steel ■ recommended water flow above 20 l / min. ■ selectable (via concealed Wall-valve module system) ■ easy to mount and maintain ■ ceiling built-in version |
|---|---|

	649.14.660 Regenhimmel 700 x 500 mm ■ Strahlart: 1. Regenstrahl 2. Wasserfall rechts 3. Wasserfall links 4. Zerstäuber (Nebel) ■ Ansteuerung der 4 Strahlzonen muss über 4 Ventile erfolgen	Rain heaven 700 x 500 mm ■ jet types: 1. rainfall 2. cascade right side 3. cascade left side 4. atomizer ■ control of the 4 jet zones must be carried out by 4 valves	A	B	C	D	E
			4.109,-	5.259,-	6.409,-	6.888,-	8.649,-
			F	G	H	I	L
			7.942,-	6.865,-	8.672,-	9.399,-	10.434,-

	649.14.670 Regenhimmel 700 x 500 mm ■ Strahlart: 1. Regenstrahl 2. Wasserfall rechts 3. Wasserfall links ■ Ansteuerung der 3 Strahlzonen muss über 3 Ventile erfolgen	Rain heaven 700 x 500 mm ■ jet types: 1. rainfall 2. cascade right side 3. cascade left side ■ control of the 3 jet zones must be carried out by 3 valves	A	B	C	D	E
			3.820,-	4.969,-	6.122,-	6.599,-	8.359,-
			F	G	H	I	L
			7.654,-	6.582,-	8.412,-	9.113,-	10.145,-

	649.14.665 Regenhimmel 700 x 500 mm ■ mit Chromotherapie (bitte Schalter hierzu separat bestellen: 649.14.745.xxx) ■ Spannungsversorgung LED: Eingangsspannung 85-260 Volt AC ■ Strahlart: 1. Regenstrahl 2. Wasserfall rechts 3. Wasserfall links 4. Zerstäuber (Nebel) ■ Ansteuerung der 4 Strahlzonen muss über 4 Ventile erfolgen	Rain heaven 700 x 500 mm ■ with chromotherapy (switch control not included; please order switch separate: 649.14.745.xxx) ■ power LED: input voltage 85-260 V AC ■ jet types: 1. rainfall 2. cascade right side 3. cascade left side 4. atomizer ■ control of the 4 jet zones must be carried out by 4 valves	A	B	C	D	E
			5.320,-	6.469,-	7.619,-	8.099,-	9.859,-
			F	G	H	I	L
			9.154,-	8.053,-	9.765,-	10.614,-	11.645,-

	649.14.675 Regenhimmel 700 x 500 mm ■ mit Chromotherapie (bitte Schalter hierzu separat bestellen: 649.14.745.xxx) ■ Spannungsversorgung LED: Eingangsspannung 85-260 Volt AC ■ Strahlart: 1. Regenstrahl 2. Wasserfall rechts 3. Wasserfall links ■ Ansteuerung der 3 Strahlzonen muss über 3 Ventile erfolgen	Rain heaven 700 x 500 mm ■ with chromotherapy (switch control not included; please order switch separate: 649.14.745.xxx) ■ power LED: input voltage 85-260 V AC ■ jet types: 1. rainfall 2. cascade right side 3. cascade left side ■ control of the 3 jet zones must be carried out by 3 valves	A	B	C	D	E
			4.998,-	6.149,-	7.299,-	7.779,-	9.539,-
			F	G	H	I	L
			8.832,-	7.768,-	9.504,-	10.289,-	11.324,-









	649.14.745 Schalter für Chromotherapie ■ mit einem Knopf ■ bestehend aus Metall	Switch control for chromotherapy ■ with 1 button ■ composed of brass plate	A	B	C	D	E
			349,-	409,-	717,-	791,-	1.043,-
			F	G	H	I	L
			645,-	490,-	944,-	1.178,-	1.683,-

BRAUSEN | SHOWERS

Maßzeichnungen unter www.joerger.de - Menü SERVICE.
 Technical specifications under www.joerger.de - menu SERVICE.

A chrom chrome	[.000]	E platin matt platinum matt	[.066]
B silbernickel polished nickel	[.035]	F nerz matt milk matt	[.096]
C nerz milk	[.095]	G schwarz-matt black matt	[.092]
C nickel matt satin nickel	[.036]	G weiß-matt white matt	[.052]
D edelmessing sunshine	[.040]	H bronze bronze	[.011]
D platin platinum	[.065]	I gold gold	[.020]
E edelmess.matt sunshine matt	[.041]	L roségold rosegold	[.022]
E gold matt gold matt	[.021]	L roségold matt rosegold matt	[.023]

Regenbrausen | Rain showers

		A	B	C	D	E	
	649.13.974 Regenbrause ½", 240 x 240 mm ■ Ausführung ganz in Metall ■ 3 mm ultra flach ■ mit Kugelgelenk ■ Anti-Kalk-System ■ <u>ohne Wandarm</u>	Rain shower head ½", 240 x 240 mm ■ full metal body ■ 3 mm ultra-thin ■ with ball joint ■ with anticalcareous system ■ <u>without wall bracket</u>	532,-	755,-	1.545,-	1.646,-	1.979,-
			F	G	H	I	L
			983,-	885,-	1.462,-	2.434,-	2.366,-
	649.13.975 Regenbrause ½", 300 x 300 mm ■ Ausführung ganz in Metall ■ 3 mm ultra flach ■ mit Kugelgelenk ■ Anti-Kalk-System ■ <u>ohne Wandarm</u>	Rain shower head ½", 300 x 300 mm ■ full metal body ■ 3 mm ultra-thin ■ with ball joint ■ with anticalcareous system ■ <u>without wall bracket</u>	756,-	1.646,-	1.854,-	1.989,-	2.398,-
			F	G	H	I	L
			2.296,-	1.854,-	2.368,-	2.896,-	3.568,-
	649.13.980 Regenbrause ½", 400 x 400 mm ■ Ausführung ganz in Metall ■ 3 mm ultra flach ■ mit Kugelgelenk ■ Anti-Kalk-System ■ <u>ohne Wandarm</u>	Rain shower head ½", 400 x 400 mm ■ full metal body ■ 3 mm ultra-thin ■ with ball joint ■ with anticalcareous system ■ <u>without wall bracket</u>	1.179,-	2.194,-	2.939,-	3.147,-	3.899,-
			F	G	H	I	L
			3.457,-	1.893,-	2.422,-	4.770,-	4.289,-
	649.13.844 Regenbrause ½", ø 240 mm ■ Ausführung ganz in Metall ■ 3 mm ultra flach ■ mit Kugelgelenk ■ Anti-Kalk-System ■ <u>ohne Wandarm</u>	Rain shower head ½", ø 240 mm ■ full metal body ■ 3 mm ultra-thin ■ with ball joint ■ with anticalcareous system ■ <u>without wall bracket</u>	499,-	1.098,-	1.289,-	1.372,-	1.622,-
			F	G	H	I	L
			1.452,-	1.289,-	1.599,-	1.927,-	2.529,-
	649.13.845 Regenbrause ½", ø 300 mm ■ Ausführung ganz in Metall ■ 3 mm ultra flach ■ mit Kugelgelenk ■ Anti-Kalk-System ■ <u>ohne Wandarm</u>	Rain shower head ½", ø 300 mm ■ full metal body ■ 3 mm ultra-thin ■ with ball joint ■ with anticalcareous system ■ <u>without wall bracket</u>	687,-	1.329,-	1.562,-	1.669,-	1.998,-
			F	G	H	I	L
			1.814,-	1.562,-	1.974,-	2.396,-	2.876,-
	649.13.850 Regenbrause ½", ø 400 mm ■ Ausführung ganz in Metall ■ 3 mm ultra flach ■ mit Kugelgelenk ■ Anti-Kalk-System ■ <u>ohne Wandarm</u>	Rain shower head ½", ø 400 mm ■ full metal body ■ 3 mm ultra-thin ■ with ball joint ■ with anticalcareous system ■ <u>without wall bracket</u>	1.139,-	1.688,-	2.480,-	2.644,-	3.188,-
			F	G	H	I	L
			2.176,-	1.856,-	2.388,-	3.932,-	4.255,-
	649.13.880 Regenbrause ½", ø 300 mm ■ Ausführung ganz in Metall ■ mit Kugelgelenk ■ Anti-Kalk-System ■ <u>ohne Wandarm</u>	Rain shower head ½", ø 300 mm ■ full metal body ■ with ball joint ■ with anticalcareous system ■ <u>without wall bracket</u>	539,-	838,-	1.411,-	1.655,-	2.037,-
			F	G	H	I	L
			1.135,-	915,-	1.192,-	2.125,-	2.389,-
Varianten Alternativen							
	649.13.870 Regenbrause ½", ø 200 mm	Rain shower head ½", ø 200 mm	A	B	C	D	E
			F	G	H	I	L
			185,-	409,-	818,-	935,-	1.217,-
			F	G	H	I	L
			697,-	592,-	892,-	1.190,-	2.094,-

BRAUSEN | SHOWERS

Maßzeichnungen unter www.joerger.de - Menü SERVICE.
 Technical specifications under www.joerger.de - menu SERVICE.

A chrom chrome	[.000]	E platin matt platinum matt	[.066]
B silbernickel polished nickel	[.035]	F nerz matt milk matt	[.096]
C nerz milk	[.095]	G schwarz-matt black matt	[.092]
C nickel matt satin nickel	[.036]	G weiß-matt white matt	[.052]
D edelmessing sunshine	[.040]	H bronze bronze	[.011]
D platin platinum	[.065]	I gold gold	[.020]
E edelmess.matt sunshine matt	[.041]	L roségold rosegold	[.022]
E gold matt gold matt	[.021]	L roségold matt rosegold matt	[.023]

	649.13.885 Regenbrause 1/2", ø 250 mm ■ Ausführung Metall ■ mit Kugelgelenk ■ Anti-Kalk-System	Rain shower head 1/2", ø 250 mm ■ material metal ■ with ball joint ■ with anticalcareous system	A	B	C	D	E
			168,-	359,-	618,-	708,-	1.049,-
			F	G	H	I	L
			899,-	589,-	968,-	1.599,-	2.196,-

	649.13.930 Regenbrause 1/2", ø 300 mm ■ Ausführung ganz in Metall ■ mit Kugelgelenk ■ Anti-Kalk-System ■ <u>ohne Wandarm</u>	Rain shower head 1/2", ø 300 mm ■ full metal body ■ with ball joint ■ with anticalcareous system ■ <u>without wall bracket</u>	A	B	C	D	E
			776,-	1.279,-	1.446,-	1.524,-	2.092,-
			F	G	H	I	L
			1.828,-	1.479,-	2.110,-	2.242,-	3.364,-

Varianten | Alternativen

	649.13.920 Regenbrause 1/2", ø 200 mm	Rain shower head 1/2", ø 200 mm	A	B	C	D	E
			260,-	619,-	824,-	895,-	1.268,-
			F	G	H	I	L
			1.085,-	821,-	1.098,-	1.389,-	2.189,-

	649.13.970 Regenbrause 1/2", 200 mm ■ Ausführung ganz in Metall ■ mit Kugelgelenk ■ Anti-Kalk-System ■ <u>ohne Wandarm</u>	Rain shower head 1/2", 200 mm ■ full metal body ■ with ball joint ■ with anticalcareous system ■ <u>without wall bracket</u>	A	B	C	D	E
			339,-	582,-	741,-	791,-	1.141,-
			F	G	H	I	L
			862,-	733,-	1.021,-	1.320,-	2.224,-

	649.13.615 Stachelkopfbrause 1/2" ■ ø 230 mm, 75 Düsen ■ Metall, Anti-Kalk-System ■ mit Kugelgelenk ■ <u>ohne Wandarm</u>	Body spray shower head 1/2" ■ ø 230 mm, 75 jets ■ full metal, anticalcareous system ■ with ball joint ■ <u>without wall bracket</u>	A	B	C	D	E
			969,-	1.232,-	1.359,-	1.416,-	1.659,-
			F	G	H	I	L
			1.496,-	1.399,-	1.718,-	2.262,-	2.739,-







	649.13.650 Kopfbrause 1/2" ■ 6 Strahlarten ■ Brausekopf ABS ■ Anti-Kalk-System ■ Anschluss 1/2" ■ <u>mit Metall-Wandarm</u>	Shower head 1/2" ■ with 6 jets ■ shower head ABS ■ anticalcareous system ■ connection 1/2" ■ <u>with metal wall bracket</u>	A	B	C	D	E
			404,-	392,-	589,-	669,-	788,-
			F	G	H	I	L
			610,-	618,-	859,-	893,-	1.489,-

BRAUSEN | SHOWERS

Maßzeichnungen unter www.joerger.de - Menü SERVICE.
 Technical specifications under www.joerger.de - menu SERVICE.

A chrom chrome	[.000]	E platin matt platinum matt	[.066]
B silbernickel polished nickel	[.035]	F nerz matt mink matt	[.096]
C nerz mink	[.095]	G schwarz-matt black matt	[.092]
C nickel matt satin nickel	[.036]	G weiß-matt white matt	[.052]
D edelmessing sunshine	[.040]	H bronze bronze	[.011]
D platin platinum	[.065]	I gold gold	[.020]
E edelmess.matt sunshine matt	[.041]	L roségold rosegold	[.022]
E gold matt gold matt	[.021]	L roségold matt rosegold matt	[.023]

Zubehör für Regenbrausen | Supplies for Rain showers

		A	B	C	D	E
	607.13.625 Wandarm 1/2"	294,-	376,-	648,-	728,-	928,-
	<ul style="list-style-type: none"> ■ Aphrodite-Design ■ Ausladung 400 mm 					
		F	G	H	I	L
		379,-	471,-	758,-	946,-	749,-
	649.13.750 Wandarm 1/2"	155,-	202,-	385,-	434,-	551,-
	<ul style="list-style-type: none"> ■ Ausladung 500 mm 					
		F	G	H	I	L
		337,-	404,-	486,-	657,-	798,-
	649.13.755 Wandarm 1/2"	129,-	288,-	316,-	349,-	439,-
	<ul style="list-style-type: none"> ■ Ausladung 350 mm 					
		F	G	H	I	L
		399,-	288,-	328,-	479,-	539,-
	649.13.785 Wandarm 1/2"	198,-	264,-	318,-	346,-	456,-
	<ul style="list-style-type: none"> ■ Ausladung 350 mm 					
		F	G	H	I	L
		399,-	334,-	436,-	518,-	740,-
	649.13.625 Wandarm 1/2"	126,-	145,-	171,-	189,-	250,-
	<ul style="list-style-type: none"> ■ Ausladung 162 mm 					
		F	G	H	I	L
		229,-	192,-	296,-	286,-	499,-
	649.13.761 Verstärkter Wandanschluß 1/2"	311,-	239,-	506,-	570,-	665,-
	<ul style="list-style-type: none"> ■ Durchmesser 90 mm 					
		F	G	H	I	L
		161,-	295,-	389,-	820,-	679,-
	649.13.765 Deckenanbindung 1/2"	166,-	418,-	690,-	776,-	951,-
	<ul style="list-style-type: none"> ■ Länge 330 mm 					
		F	G	H	I	L
		263,-	210,-	314,-	1.040,-	589,-
	649.13.770 Deckenanbindung 1/2"	94,-	268,-	421,-	474,-	558,-
	<ul style="list-style-type: none"> ■ Länge 190 mm 					
		F	G	H	I	L
		167,-	195,-	309,-	681,-	574,-

BRAUSEN | SHOWERS

Maßzeichnungen unter www.joerger.de - Menü SERVICE.
 Technical specifications under www.joerger.de - menu SERVICE.

A chrom chrome	[.000]	E platin matt platinum matt	[.066]
B silbernickel polished nickel	[.035]	F nerz matt milk matt	[.096]
C nerz milk	[.095]	G schwarz-matt black matt	[.092]
C nickel matt satin nickel	[.036]	G weiß-matt white matt	[.052]
D edelmessing sunshine	[.040]	H bronze bronze	[.011]
D platin platinum	[.065]	I gold gold	[.020]
E edelmess.matt sunshine matt	[.041]	L roségold rosegold	[.022]
E gold matt gold matt	[.021]	L roségold matt rosegold matt	[.023]



649.13.771 Deckenanbindung ½“
 ■ Länge 150 mm

Ceiling bracket ½“
 ■ length 150 mm

A	B	C	D	E
176,-	292,-	350,-	395,-	462,-
F	G	H	I	L
446,-	350,-	442,-	558,-	836,-

Seitenbrausen | Side showers



649.13.550 Seitenbrause ½“
 ■ Rosette, Wandmontage
 ■ Brausekopf schwenkbar
 ■ Anti-Kalk-System

Body spray side shower ½“
 ■ escutcheon, wall assembly
 ■ swivel shower head
 ■ anticalcareous system

A	B	C	D	E
208,-	313,-	351,-	364,-	455,-
F	G	H	I	L
418,-	373,-	429,-	525,-	765,-



649.13.460 Seitenbrause ½“
 ■ Rosette
 ■ Brausekopf schwenkbar
 ■ Anti-Kalk-System
 ■ 2 Strahlarten: Soft, Massage

Body spray side shower ½“
 ■ escutcheon
 ■ swivel shower head
 ■ anticalcareous system
 ■ 2 jets: soft, massage

A	B	C	D	E
199,-	374,-	403,-	453,-	556,-
F	G	H	I	L
516,-	424,-	534,-	586,-	855,-



649.13.465 Seitenbrause ½“
 ■ Rosette
 ■ Brausekopf schwenkbar
 ■ Anti-Kalk-System
 ■ 2 Strahlarten: Soft, Massage

Body spray side shower ½“
 ■ escutcheon
 ■ swivel shower head
 ■ anticalcareous system
 ■ 2 jets: soft, massage

A	B	C	D	E
267,-	517,-	550,-	618,-	757,-
F	G	H	I	L
705,-	558,-	726,-	799,-	1.164,-



649.13.470 Seitenbrause ½“
 ■ Rosette
 ■ Brausekopf schwenkbar
 ■ Anti-Kalk-System
 ■ 2 Strahlarten: Soft, Massage

Body spray side shower ½“
 ■ escutcheon
 ■ swivel shower head
 ■ anticalcareous system
 ■ 2 jets: soft, massage

A	B	C	D	E
237,-	392,-	492,-	553,-	672,-
F	G	H	I	L
638,-	495,-	574,-	733,-	1.069,-



649.13.526 Seitenbrause ½“
 ■ Rosette 125 x 125 mm, Wandmontage
 ■ Brausekopf schwenkbar, 20°
 ■ Anti-Kalk-System
 ■ Ausführung: Kunststoff

Body spray side shower ½“
 ■ escutcheon 125 x 125 mm, wall assembly
 ■ swivel shower head, 20°
 ■ anticalcareous system
 ■ plastic

A	B	C	D	E
186,-	329,-	384,-	406,-	542,-
F	G	H	I	L
508,-	392,-	472,-	659,-	944,-



649.13.530 Seitenbrause ½“
 ■ Rosette 125 x 125 mm, Wandmontage
 ■ Brausekopf schwenkbar, 20°
 ■ Anti-Kalk-System
 ■ Ausführung: Kunststoff

Body spray side shower ½“
 ■ escutcheon 125 x 125 mm, wall assembly
 ■ swivel shower head, 20°
 ■ anticalcareous system
 ■ plastic

A	B	C	D	E
167,-	224,-	385,-	406,-	555,-
F	G	H	I	L
495,-	314,-	472,-	665,-	854,-



649.13.519 Seitenbrause ½“
 ■ Rosette ø 130 mm, Wandmontage
 ■ Brausekopf schwenkbar, 20°
 ■ Anti-Kalk-System
 ■ Ausführung: Kunststoff

Body spray side shower ½“
 ■ escutcheon ø 130 mm, wall assembly
 ■ swivel shower head, 20°
 ■ anticalcareous system
 ■ material: plastic

A	B	C	D	E
167,-	326,-	385,-	399,-	542,-
F	G	H	I	L
496,-	376,-	472,-	634,-	949,-

BRAUSEN | SHOWERS

Maßzeichnungen unter www.joerger.de - Menü SERVICE.
 Technical specifications under www.joerger.de - menu SERVICE.

A chrom chrome	[.000]	E platin matt platinum matt	[.066]
B silbernickel polished nickel	[.035]	F nerz matt mink matt	[.096]
C nerz mink	[.095]	G schwarz-matt black matt	[.092]
C nickel matt satin nickel	[.036]	G weiß-matt white matt	[.052]
D edelmessing sunshine	[.040]	H bronze bronze	[.011]
D platin platinum	[.065]	I gold gold	[.020]
E edelmess.matt sunshine matt	[.041]	L roségold rosegold	[.022]
E gold matt gold matt	[.021]	L roségold matt rosegold matt	[.023]

Handbrausen | Hand showers

	649.13.395 Handbrause 1/2" ■ 3 Strahlarten: Normal, Massage, Soft, Anti-Kalk-System ■ Ausführung ABS ■ Anschluß 1/2"	Hand shower 1/2" ■ with 3 jets: normal, hydromassage, soft ■ ABS anticalcareous system ■ connection 1/2"	A	B	C	D	E
			165,-	239,-	299,-	349,-	509,-
			F	G	H	I	L
			418,-	297,-	436,-	648,-	856,-

	649.13.381 Handbrause 1/2" ■ Anti-Kalk-System ■ 3 Strahlarten: Normal, Soft, Schwall ■ Anschluß 1/2" ■ Ausführung ABS	Hand shower 1/2" ■ anticalcareous system ■ with 3 jets: normal, soft, cascade ■ connection 1/2" ■ material ABS	A	B	C	D	E
			69,-	172,-	259,-	299,-	476,-
			F	G	H	I	L
			392,-	289,-	449,-	668,-	869,-

	649.13.391 Handbrause 1/2" ■ Ausführung Metall ■ Anti-Kalk-System ■ Anschluß 1/2"	Hand shower 1/2" ■ brass ■ anticalcareous system ■ connection 1/2"	A	B	C	D	E
			208,-	398,-	426,-	464,-	578,-
			F	G	H	I	L
			546,-	394,-	586,-	718,-	956,-

	649.13.360 Handbrause 1/2" ■ Ausführung Metall ■ Anti-Kalk-System ■ Anschluß 1/2"	Hand shower 1/2" ■ brass ■ anticalcareous system ■ connection 1/2"	A	B	C	D	E
			208,-	396,-	427,-	481,-	650,-
			F	G	H	I	L
			594,-	418,-	606,-	633,-	798,-

	649.13.335 Handbrause 1/2" ■ Ausführung Metall ■ Anti-Kalk-System ■ Anschluß 1/2"	Hand shower 1/2" ■ heavy cast brass ■ anticalcareous system ■ connection 1/2"	A	B	C	D	E
			216,-	269,-	316,-	327,-	402,-
			F	G	H	I	L
			363,-	336,-	538,-	628,-	919,-

	649.13.330 Handbrause 1/2" ■ gegossene Metall-Ausführung ■ Anti-Kalk-System ■ Anschluß 1/2"	Hand shower 1/2" ■ heavy cast brass ■ anticalcareous system ■ connection 1/2"	A	B	C	D	E
			338,-	345,-	341,-	347,-	399,-
			F	G	H	I	L
			340,-	438,-	518,-	431,-	759,-

	649.13.371 Handbrause 1/2" ■ Metall-Ausführung ■ Anti-Kalk-System ■ Anschluß 1/2"	Hand shower 1/2" ■ brass ■ anticalcareous system ■ connection 1/2"	A	B	C	D	E
			159,-	256,-	376,-	384,-	492,-
			F	G	H	I	L
			435,-	338,-	424,-	568,-	749,-

BRAUSEN | SHOWERS

Maßzeichnungen unter www.joerger.de - Menü SERVICE.
 Technical specifications under www.joerger.de - menu SERVICE.

A chrom chrome	[.000]	E platin matt platinum matt	[.066]
B silbernickel polished nickel	[.035]	F nerz matt milk matt	[.096]
C nerz milk	[.095]	G schwarz-matt black matt	[.092]
C nickel matt satin nickel	[.036]	G weiß-matt white matt	[.052]
D edelmessing sunshine	[.040]	H bronze bronze	[.011]
D platin platinum	[.065]	I gold gold	[.020]
E edelmess.matt sunshine matt	[.041]	L roségold rosegold	[.022]
E gold matt gold matt	[.021]	L roségold matt rosegold matt	[.023]

	649.13.375 Handbrause 1/2" <ul style="list-style-type: none"> ■ Ausführung Metall ■ Anti-Kalk-System ■ Anschluß 1/2" 	Hand shower 1/2" <ul style="list-style-type: none"> ■ brass ■ anticalcareous system ■ connection 1/2" 	A	B	C	D	E
			168,-	212,-	288,-	324,-	379,-
			F	G	H	I	L
			352,-	314,-	392,-	439,-	629,-

	649.13.361 Handbrause 1/2" <ul style="list-style-type: none"> ■ Ausführung Metall ■ Anti-Kalk-System ■ Anschluß 1/2" 	Hand shower 1/2" <ul style="list-style-type: none"> ■ brass ■ anticalcareous system ■ connection 1/2" 	A	B	C	D	E
			114,-	160,-	189,-	226,-	314,-
			F	G	H	I	L
			268,-	232,-	324,-	379,-	568,-

Hygienebrausen | Spray Handshowers

	649.13.338 Hygienebrause, klassisch <ul style="list-style-type: none"> ■ komplett aus Metall ■ einstrahlig ■ Bedienung über Druckhebel 	Spray handshower, classical <ul style="list-style-type: none"> ■ completely metal ■ one jet ■ push-lever operation 	A	B	C	D	E
			185,-	226,-	298,-	311,-	403,-
			F	G	H	I	L
			205,-	239,-	481,-	517,-	629,-

	649.13.337 Hygienebrause, modern <ul style="list-style-type: none"> ■ komplett aus Metall ■ einstrahlig ■ Bedienung über Druckhebel 	Spray handshower, modern <ul style="list-style-type: none"> ■ completely metal ■ one jet ■ push-lever operation 	A	B	C	D	E
			175,-	229,-	288,-	300,-	392,-
			F	G	H	I	L
			208,-	241,-	471,-	506,-	636,-

	649.13.336 Hygienebrause, Eco <ul style="list-style-type: none"> ■ Ausführung ABS ■ einstrahlig ■ Bedienung über Druckhebel 	Spray handshower, eco <ul style="list-style-type: none"> ■ ABS ■ one jet ■ push-lever operation 	A	B	C	D	E
			97,-	206,-	217,-	230,-	322,-
			F	G	H	I	L
			199,-	217,-		370,-	619,-

	649.13.334 Hygienebrause, quadratisch <ul style="list-style-type: none"> ■ komplett aus Metall ■ einstrahlig ■ Bedienung über Druckhebel 	Spray handshower, square <ul style="list-style-type: none"> ■ completely metal ■ one jet ■ push-lever operation 	A	B	C	D	E
			214,-	286,-	321,-	339,-	429,-
			F	G	H	I	L
			286,-	322,-	556,-	592,-	729,-



Serienübergreifendes | Universals



Oberflächen | colours

Folgende Oberflächen sind bei dieser Serie möglich |
The following colours are possible with this collection

chrom	chrome	[.000]	PG A
silbernickel	polished nickel	[.035]	PG B
nerz	mink	[.095]	PG C
nickel matt	satin nickel	[.036]	PG C
edelmessing	sunshine	[.040]	PG D
platin	platinum	[.065]	PG D
edelmessing matt	sunshine matt	[.041]	PG E
gold matt	gold matt	[.021]	PG E
platin matt	platinum matt	[.066]	PG E
nerz matt	mink matt	[.096]	PG F
schwarz matt	black matt	[.092]	PG G
weiß matt	white matt	[.052]	PG G
bronze	bronze	[.011]	PG H
gold	gold	[.020]	PG I
roségold	rosegold	[.022]	PG L
roségold matt	rosegold matt	[.023]	PG L

Andere Oberflächen auf Anfrage |
Different colours on request

Auf Anfrage können wir Produkte von Drittanbietern auch gerne passend zu unseren Oberflächen veredeln (vorbehaltlich der Eignungsprüfung) | Third-party products may be plated matching to our colours on request (subject to valuation of suitability)

Montagesysteme

| Assembly systems

ab Seite | from page 238

Siphons | Siphons

ab Seite | from page 239

Ablaufgarnituren

| Pop-up waste systems

ab Seite | from page 240

Spindelverlängerungen

| Spindle extensions

ab Seite | from page 242

Metallspiralschläuche

| Metal shower hoses





ab Seite | from page 244

Serienübergreifendes Universals

Maßzeichnungen unter www.joerger.de - Menü SERVICE.
Technical specifications under www.joerger.de - menu SERVICE.

A chrom chrome	[.000]	E platin matt platinum matt	[.066]
B silbernickel polished nickel	[.035]	F nerz matt mink matt	[.096]
C nerz mink	[.095]	G schwarz-matt black matt	[.092]
C nickel matt satin nickel	[.036]	G weiß-matt white matt	[.052]
D edelmessing sunshine	[.040]	H bronze bronze	[.011]
D platin platinum	[.065]	I gold gold	[.020]
E edelmess.matt sunshine matt	[.041]	L roségold rosegold	[.022]
E gold matt gold matt	[.021]	L roségold matt rosegold matt	[.023]

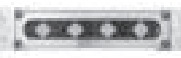
Montagesysteme | Assembly systems

	<p>649.40.140 Montagesystem, komplett</p> <ul style="list-style-type: none"> ■ für Wannenrandarmaturen für 4-Loch Armaturen ■ bestehend aus 649.40.150, 649.40.160 und 649.40.170 	<p>Assembly system, complete</p> <ul style="list-style-type: none"> ■ for tub rim installation for 4-hole taps ■ consisting of 649.40.150, 649.40.160 and 649.40.170 	<table border="1" style="width: 100%; border-collapse: collapse;"> <tr> <th style="width: 10%;">A</th> <th style="width: 10%;"></th> <th style="width: 10%;"></th> <th style="width: 10%;"></th> <th style="width: 10%;"></th> </tr> <tr> <td style="text-align: center;">1.039,-</td> <td></td> <td></td> <td></td> <td></td> </tr> </table>	A					1.039,-				
A													
1.039,-													
<p><u>Einzelkomponenten Single components</u></p>													
	<p>649.40.150 Montageblock-Standträgersystem</p> <ul style="list-style-type: none"> ■ selbsttragendes, freistehendes Trägersystem ■ vorbereitet zur Trockenverkleidung ■ höheneinstellbar: 500 - 850 mm 	<p>Assembly bloc support system</p> <ul style="list-style-type: none"> ■ self-supporting, free standing support system ■ suitable for dry cladding ■ adjustable in height: 500 - 850 mm 	<table border="1" style="width: 100%; border-collapse: collapse;"> <tr> <th style="width: 10%;">A</th> <th style="width: 10%;"></th> <th style="width: 10%;"></th> <th style="width: 10%;"></th> <th style="width: 10%;"></th> </tr> <tr> <td style="text-align: center;">529,-</td> <td></td> <td></td> <td></td> <td></td> </tr> </table>	A					529,-				
A													
529,-													
	<p>649.40.160 Montageplatten-Modul</p> <ul style="list-style-type: none"> ■ Abmessung 675 x 150 mm ■ von außen nicht sichtbare Befestigung ■ einstellbare Montageprismen, für Armaturen-Schaftdurchmesser 10-70mm 	<p>Assembly plate module</p> <ul style="list-style-type: none"> ■ dimension 675 x 150 mm ■ fixings, not visible from the outside ■ adjustable securing plates universal for taps of between 10-70 mm shaft diameter 	<table border="1" style="width: 100%; border-collapse: collapse;"> <tr> <th style="width: 10%;">A</th> <th style="width: 10%;"></th> <th style="width: 10%;"></th> <th style="width: 10%;"></th> <th style="width: 10%;"></th> </tr> <tr> <td style="text-align: center;">308,-</td> <td></td> <td></td> <td></td> <td></td> </tr> </table>	A					308,-				
A													
308,-													
	<p>649.40.170 Schlauchkasten mit Ableitung</p> <ul style="list-style-type: none"> ■ für Massivwände od. Standträgersystem ■ drehbarer Ablaufstutzen ■ flexible Tropfwasserableitung ■ Rückschlagklappe 	<p>Hose box with drain pipe</p> <ul style="list-style-type: none"> ■ for solid walls or support systems ■ rotating central drain pipe ■ flexible drain pipe branch ■ non return trap 	<table border="1" style="width: 100%; border-collapse: collapse;"> <tr> <th style="width: 10%;">A</th> <th style="width: 10%;"></th> <th style="width: 10%;"></th> <th style="width: 10%;"></th> <th style="width: 10%;"></th> </tr> <tr> <td style="text-align: center;">259,-</td> <td></td> <td></td> <td></td> <td></td> </tr> </table>	A					259,-				
A													
259,-													

Serienübergreifendes Universals

Maßzeichnungen unter www.joerger.de - Menü SERVICE.
Technical specifications under www.joerger.de - menu SERVICE.

A chrom chrome	[.000]	E platin matt platinum matt	[.066]
B silbernickel polished nickel	[.035]	F nerz matt mink matt	[.096]
C nerz mink	[.095]	G schwarz-matt black matt	[.092]
C nickel matt satin nickel	[.036]	G weiß-matt white matt	[.052]
D edelmessing sunshine	[.040]	H bronze bronze	[.011]
D platin platinum	[.065]	I gold gold	[.020]
E edelmess.matt sunshine matt	[.041]	L roségold rosegold	[.022]
E gold matt gold matt	[.021]	L roségold matt rosegold matt	[.023]

Siphons | Siphons

	649.15.380 Waschtisch-Tassensiphon 1 1/4" <ul style="list-style-type: none"> ■ gegossene Ausführung ■ Rosette ■ Abgangsrohr ø 32 mm ■ Tauchrohrlänge 165 mm 	Washbasin cupped siphon trap 1 1/4" <ul style="list-style-type: none"> ■ heavy cast brass ■ escutcheon ■ outlet tube ø 32 mm ■ dip pipe 165 mm 	A	B	C	D	E	
				289,-	349,-	423,-	440,-	569,-
				F	G	H	I	L
			492,-	497,-	642,-	739,-	925,-	

	649.15.340 Waschtisch-Tassensiphon 1 1/4" <ul style="list-style-type: none"> ■ schwere Ausführung ■ Rosette ■ Abgangsrohr ø 32 mm ■ Tauchrohrlänge 165 mm 	Washbasin cupped siphon trap 1 1/4" <ul style="list-style-type: none"> ■ heavy brass ■ escutcheon ■ outlet tube ø 32 mm ■ dip pipe 165 mm 	A	B	C	D	E	
				195,-	296,-	368,-	429,-	568,-
				F	G	H	I	L
			498,-	378,-	539,-	686,-	832,-	

	649.15.310 Waschtisch-Tassensiphon 1 1/4" <ul style="list-style-type: none"> ■ Rosette ■ Abgangsrohr ø 32 mm ■ Tauchrohrlänge 150 mm 	Washbasin cupped siphon trap 1 1/4" <ul style="list-style-type: none"> ■ escutcheon ■ outlet tube ø 32 mm ■ dip pipe 150 mm 	A	B	C	D	E	
				76,-	128,-	270,-	304,-	343,-
				F	G	H	I	L
			245,-	320,-	476,-	430,-	762,-	

	649.15.330 Bidet-Tassensiphon 1 1/4" <ul style="list-style-type: none"> ■ Rosette ■ Abgangsrohr ø 32 mm 	Bidet cupped siphon trap 1 1/4" <ul style="list-style-type: none"> ■ escutcheon ■ outlet tube ø 32 mm 	A	B	C	D	E	
				98,-	166,-	276,-	332,-	472,-
				F	G	H	I	L
			399,-	364,-	508,-	648,-	796,-	

	649.15.350 Waschtisch-Röhrensiphon 1 1/4" <ul style="list-style-type: none"> ■ Rosette ■ Abgangsrohr ø 32 mm 	Washbasin tubular siphon trap 1 1/4" <ul style="list-style-type: none"> ■ escutcheon ■ outlet tube ø 32 mm 	A	B	C	D	E	
				43,-	108,-	239,-	268,-	305,-
				F	G	H	I	L
			230,-	305,-	464,-	384,-	748,-	



	649.15.370 Bidet-Röhrensiphon 1 1/4" <ul style="list-style-type: none"> ■ Rosette ■ Abgangsrohr ø 32 mm 	Bidet tubular siphon trap 1 1/4" <ul style="list-style-type: none"> ■ escutcheon ■ outlet tube ø 32 mm 	A	B	C	D	E	
				58,-	99,-	263,-	294,-	334,-
				F	G	H	I	L
			185,-	307,-	468,-	422,-	750,-	

Serienübergreifendes Universals

Maßzeichnungen unter www.joerger.de - Menü SERVICE.
Technical specifications under www.joerger.de - menu SERVICE.

A chrom chrome	[.000]	E platin matt platinum matt	[.066]
B silbernickel polished nickel	[.035]	F nerz matt mink matt	[.096]
C nerz mink	[.095]	G schwarz-matt black matt	[.092]
C nickel matt satin nickel	[.036]	G weiß-matt white matt	[.052]
D edelmessing sunshine	[.040]	H bronze bronze	[.011]
D platin platinum	[.065]	I gold gold	[.020]
E edelmess.matt sunshine matt	[.041]	L roségold rosegold	[.022]
E gold matt gold matt	[.021]	L roségold matt rosegold matt	[.023]

Kupferrohre | Copper tubes

	649.15.530 Kupferrohr, 300 mm	Copper tube, 300 mm	A	B	C	D	E
	<ul style="list-style-type: none"> mit Bördel, für Quetschverschraubung 	<ul style="list-style-type: none"> with flange, for compression joint 	15,-	38,-	55,-	62,-	74,-
Variante Alternative			F	G	H	I	L
			69,-	75,-	94,-	112,-	169,-
	649.15.550 Kupferrohr, 500 mm	Copper tube, 500 mm	A	B	C	D	E
	<ul style="list-style-type: none"> mit Bördel, für Quetschverschraubung 	<ul style="list-style-type: none"> with flange, for compression joint 	20,-	58,-	77,-	87,-	102,-
			F	G	H	I	L
			97,-	77,-	96,-	134,-	219,-

Ablaufgarnituren | Waste systems

	649.15.270 Zwangsablaufventil	Restraint drain/waste	A	B	C	D	E
	<ul style="list-style-type: none"> Schaftlänge 70 mm 	<ul style="list-style-type: none"> length of shaft 70 mm 	68,-	129,-	185,-	239,-	312,-
Variante Alternative			F	G	H	I	L
			299,-	176,-	394,-	429,-	582,-
	649.15.271 Zwangsablaufventil	Restraint drain/waste	A	B	C	D	E
	<ul style="list-style-type: none"> Schaftlänge 100 mm 	<ul style="list-style-type: none"> length of shaft 100 mm 	72,-	138,-	196,-	254,-	329,-
			F	G	H	I	L
			318,-	186,-	418,-	454,-	616,-
	649.15.290 Zwangsablaufventil	Restraint drain/waste	A	B	C	D	E
	<ul style="list-style-type: none"> Schaftlänge 70 mm 	<ul style="list-style-type: none"> length of shaft 70 mm 	93,-	116,-	172,-	192,-	255,-
			F	G	H	I	L
			224,-	247,-	414,-	464,-	612,-
	649.15.276 Zwangsablaufventil	Restraint drain/waste	A	B	C	D	E
	<ul style="list-style-type: none"> mit rundem Ablaufstopfen mit zentraler Klemmschraube 	<ul style="list-style-type: none"> with round plug with center fixing screw 	72,-	96,-	134,-	149,-	197,-
			F	G	H	I	L
			148,-	173,-	392,-	208,-	479,-
	649.15.296 Zwangsablaufventil	Restraint drain/waste	A	B	C	D	E
	<ul style="list-style-type: none"> mit quadratischem Ablaufstopfen mit zentraler Klemmschraube 	<ul style="list-style-type: none"> with square plug with center fixing screw 	102,-	152,-	188,-	204,-	280,-
			F	G	H	I	L
			247,-	206,-	424,-	315,-	509,-
	649.15.285 Ablaufventil mit Klick-Verschuß	Drain/waste with click system	A	B	C	D	E
	<ul style="list-style-type: none"> mit zentraler Klemmschraube 	<ul style="list-style-type: none"> with center fixing screw 	86,-	119,-	156,-	175,-	230,-
			F	G	H	I	L
			176,-	175,-	394,-	245,-	482,-

Serienübergreifendes Universals

Maßzeichnungen unter www.joerger.de - Menü SERVICE.
Technical specifications under www.joerger.de - menu SERVICE.

A chrom chrome	[.000]	E platin matt platinum matt	[.066]
B silbernickel polished nickel	[.035]	F nerz matt milk matt	[.096]
C nerz milk	[.095]	G schwarz-matt black matt	[.092]
C nickel matt satin nickel	[.036]	G weiß-matt white matt	[.052]
D edelmessing sunshine	[.040]	H bronze bronze	[.011]
D platin platinum	[.065]	I gold gold	[.020]
E edelmess.matt sunshine matt	[.041]	L roségold rosegold	[.022]
E gold matt gold matt	[.021]	L roségold matt rosegold matt	[.023]



649.15.280 Ablaufventil mit Klick-Verschluß
 ■ Schaftlänge 70 mm

Drain/waste with click system
 ■ length of shaft 70 mm

A	B	C	D	E
86,-	129,-	199,-	224,-	263,-
F	G	H	I	L
185,-	184,-	406,-	361,-	489,-

Das Klick-System ermöglicht dem Benutzer das Becken ohne Überlauf zu verschließen. Wir weisen darauf hin, dass der Einbau dieses System auf Kundenwunsch erfolgt und wir keinerlei Haftung für Schäden übernehmen, die durch das Verschließen des Ablaufes resultieren.

The click system offers the possibility to close the basin without an overflow. We point out that the installation of this system takes place on request of the customer, therefore we cannot be held responsible for any damage which result from the closure of the drain.



649.15.212 Ab- und Überlaufgarnitur Einbauset
 ■ Bowdenzuglänge 1070 mm
 ■ einschließlich Geruchverschluß
 ■ Abgang 40/50 mm

Waste and overflow set
Built-in element
 ■ bowden cable 1070 mm
 ■ including odor seal
 ■ outlet 40/50 mm

A	B	C	D	E
215,-				

Variante | Alternative

649.15.222 Ab- und Überlaufgarnitur Einbauset
 ■ Bowdenzuglänge 725 mm

Waste and overflow set
Built-in element
 ■ bowden cable 725 mm

A	B	C	D	E
196,-				

Benötigt | Required

649.50.210 Fertigmontageset
 ■ zu Einbauset 649.15.212 und 649.15.222

Assembly set
 ■ for built-in element 649.15.212 and 649.15.222



A	B	C	D	E
59,-	213,-	256,-	288,-	353,-
F	G	H	I	L
265,-	250,-	309,-	430,-	529,-



649.15.214 Wanneneinlauf mit Ab- und Überlaufgarnitur, Einbauset
 ■ Bowdenzuglänge 1070 mm
 ■ einschließlich Geruchverschluß
 ■ Abgang 40/50 mm

Bathtub filler with waste and overflow set, built-in element
 ■ bowden cable 1070 mm
 ■ including odor seal
 ■ outlet 40/50 mm

A	B	C	D	E
528,-				

Variante | Alternative

649.15.224 Wanneneinlauf mit Ab- und Überlaufgarnitur, Einbauset
 ■ Bowdenzuglänge 725 mm

Bathtub filler with waste and overflow set, built-in element
 ■ bowden cable 725 mm

A	B	C	D	E
492,-				

Benötigt | Required

649.50.214 Fertigmontageset
 ■ zu Einbauset 649.15.214 und 649.15.224

Assembly set
 ■ for built-in element 649.15.214 and 649.15.224





A	B	C	D	E
488,-	489,-	552,-	621,-	703,-
F	G	H	I	L
645,-	539,-	670,-	867,-	979,-

Serienübergreifendes Universals

Maßzeichnungen unter www.joerger.de - Menü SERVICE.
Technical specifications under www.joerger.de - menu SERVICE.

A chrom chrome	[.000]	E platin matt platinum matt	[.066]
B silbernickel polished nickel	[.035]	F nerz matt milk matt	[.096]
C nerz milk	[.095]	G schwarz-matt black matt	[.092]
C nickel matt satin nickel	[.036]	G weiß-matt white matt	[.052]
D edelmessing sunshine	[.040]	H bronze bronze	[.011]
D platin platinum	[.065]	I gold gold	[.020]
E edelmess.matt sunshine matt	[.041]	L roségold rosegold	[.022]
E gold matt gold matt	[.021]	L roségold matt rosegold matt	[.023]

	649.15.232 Ablaufgarnitur, Einbauset <ul style="list-style-type: none"> ■ Ablaufloch ø 52 mm 	Waste fitting, built-in element <ul style="list-style-type: none"> ■ for shower trays, drain ø 52 mm 	A				
			39,-				

	649.50.230 Fertigmontageset <ul style="list-style-type: none"> ■ zu Einbauset 649.15.232 	Assembly set <ul style="list-style-type: none"> ■ for built-in element 649.15.232 	A	B	C	D	E
			49,-	126,-	159,-	178,-	218,-
			F	G	H	I	L
			114,-	156,-	207,-	258,-	369,-

	649.15.252 Ablaufgarnitur, Einbauset <ul style="list-style-type: none"> ■ Ablaufloch ø 90 mm 	Waste fitting, built-in element <ul style="list-style-type: none"> ■ for shower trays, drain ø 90 mm 	A				
			60,-				

	649.50.250 Fertigmontageset <ul style="list-style-type: none"> ■ zu Einbauset 649.15.252 	Assembly set <ul style="list-style-type: none"> ■ for built-in element 649.15.252 	A	B	C	D	E
			83,-	156,-	190,-	213,-	251,-
			F	G	H	I	L
			159,-	186,-	240,-	294,-	419,-

	109.10.970 Bausatz-Vormontage <ul style="list-style-type: none"> ■ Bodenplatte mit Befestigungsset ■ für Wasserzufuhrstandrohre 109.15.260, 600.15.260, 615.15.260 und 634.15.260 	Assembly set for pre-installation <ul style="list-style-type: none"> ■ joint plate with fixing set ■ for water supply pipes 109.15.260, 600.15.260, 615.15.260 and 634.15.260 	A				
			459,-				

	649.10.970 Bausatz-Vormontage <ul style="list-style-type: none"> ■ Bodenplatte mit Befestigungsset 	Assembly set for pre-installation <ul style="list-style-type: none"> ■ joint plate with fixing set 	A				
			549,-				

Spindelverlängerungen | Spindle extensions

	649.20.550 Verlängerungssatz, 38 mm <ul style="list-style-type: none"> ■ für UP-Ventile ■ für UP 3-Wege Umstellung 	Extension set, 38 mm <ul style="list-style-type: none"> ■ for concealed wall valves ■ for concealed 3-position diverter 	A	B	C	D	E
			86,-	89,-	112,-	125,-	150,-
			F	G	H	I	L
			54,-	110,-	192,-	174,-	328,-

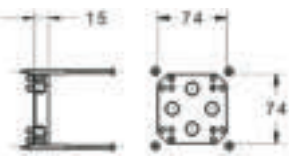
	649.41.360 Verlängerungssatz, 15 mm <ul style="list-style-type: none"> ■ für UP-Einbaubox ½" (649.40.360.000) ■ maximal 2 Adapter entsprechend 30 mm Verlängerung dürfen montiert werden 	Extension set, 15 mm <ul style="list-style-type: none"> ■ for concealed wall box ½" (649.40.360.000) ■ maximum 2 sets corresponding to 30 mm extension may be installed 	A				
			217,-				

Serienübergreifendes Universals

Maßzeichnungen unter www.joerger.de - Menü SERVICE.
Technical specifications under www.joerger.de - menu SERVICE.

A chrom chrome	[.000]	E platin matt platinum matt	[.066]
B silbernickel polished nickel	[.035]	F nerz matt mink matt	[.096]
C nerz mink	[.095]	G schwarz-matt black matt	[.092]
C nickel matt satin nickel	[.036]	G weiß-matt white matt	[.052]
D edelmessing sunshine	[.040]	H bronze bronze	[.011]
D platin platinum	[.065]	I gold gold	[.020]
E edelmess.matt sunshine matt	[.041]	L roségold rosegold	[.022]
E gold matt gold matt	[.021]	L roségold matt rosegold matt	[.023]



848.14.184 Wechsel-Adapter

- zum Tauschen der Wassereingänge Kalt und Warm
- passend zu Einbaubox 649.40.360.000
- der Adapter wird zwischen Grundplatte und Funktionseinheit eingesetzt und baut um 15 mm auf
- es können auch die Abgänge Oben / Unten getauscht werden

Alternation Adapter

- to switch the water inlets cold and warm
- suitable for concealed box 649.40.360.000
- the adapter is inserted between the base plate and the functional unit and builds up by 15 mm
- it is also possible to switch the top / bottom outlets

A	B	C	D	E
218,-				



848.14.191 Distanzadapter, 15 mm

- für zu flachen Einbau
- passend zu Einbaubox 649.40.360.000
- für runde Abdeckplatten (ø170 mm)

Distance adapter, 15 mm

- for too flat installation
- matching to concealed box 649.40.360.000
- for round cover plates (ø170 mm)

A	B	C	D	E
145,-	279,-	177,-	197,-	236,-
F	G	H	I	L
431,-	174,-	629,-	544,-	1.139,-



848.14.192 Distanzadapter, 15 mm

- für zu flachen Einbau
- passend zu Einbaubox 649.40.360.000
- für quadratische Abdeckplatten (150 x 150)

Distance adapter, 15 mm

- for too flat installation
- matching to concealed box 649.40.360.000
- for square cover plates (150 x 150)

A	B	C	D	E
155,-	299,-	190,-	213,-	255,-
F	G	H	I	L
465,-	186,-	639,-	585,-	1.149,-



649.41.555 Verlängerungssatz, 35 mm

- für UP-Thermostat ¾" ohne Mengenregulierung (649.40.555.000)

Extension set, 35 mm

- for concealed wall thermostat ¾" without flow control (649.40.555.000)

A	B	C	D	E
435,-				



649.10.369 Verlängerungssatz, 15 mm

- für Wand-Waschtisch 1-Hand Batterie CHARLESTON ROYAL und CHARLESTON SQUARE
- passend zu Einbaukörper 649.10.360.000

Extension set, 15 mm

- for single lever wall-washbasin mixer CHARLESTON ROYAL and CHARLESTON SQUARE
- matching to body 649.10.360.000

A	B	C	D	E
180,-				

Serienübergreifendes Universals

Maßzeichnungen unter www.joerger.de - Menü SERVICE.
Technical specifications under www.joerger.de - menu SERVICE.

A chrom chrome	[.000]	E platin matt platinum matt	[.066]
B silbernickel polished nickel	[.035]	F nerz matt mink matt	[.096]
C nerz mink	[.095]	G schwarz-matt black matt	[.092]
C nickel matt satin nickel	[.036]	G weiß-matt white matt	[.052]
D edelmessing sunshine	[.040]	H bronze bronze	[.011]
D platin platinum	[.065]	I gold gold	[.020]
E edelmess.matt sunshine matt	[.041]	L roségold rosegold	[.022]
E gold matt gold matt	[.021]	L roségold matt rosegold matt	[.023]

Metallspiralschläuche | Metal shower hoses



649.13.345 Metallspiralschlauch, 1500 mm
■ Anschlüsse: ½" Konus x ½"
Metal shower hose, 1500 mm
■ connections: ½" conical x ½"

A	B	C	D	E
39,-	168,-	214,-	233,-	359,-
F	G	H	I	L
227,-	212,-	389,-	418,-	449,-

Varianten | Alternatives

649.13.349 Metallspiralschlauch, 1750 mm
■ Anschlüsse: ½" Konus x ½"
Metal shower hose, 1750 mm
■ connections: ½" conical x ½"

A	B	C	D	E
52,-	192,-	244,-	266,-	415,-
F	G	H	I	L
262,-	239,-	458,-	489,-	498,-

649.13.343 Metallspiralschlauch, 2000 mm
■ Anschlüsse: ½" Konus x ½"
Metal shower hose, 2000 mm
■ connections: ½" conical x ½"

A	B	C	D	E
76,-	236,-	303,-	328,-	481,-
F	G	H	I	L
301,-	296,-	556,-	590,-	579,-

649.13.346 Metallspiralschlauch, 1500 mm
■ Anschlüsse: ½" Konus x ¾"
Metal shower hose, 1500 mm
■ connections: ½" conical x ¾"

A	B	C	D	E
88,-	222,-	282,-	308,-	461,-
F	G	H	I	L
231,-	276,-	499,-	569,-	456,-

649.13.351 Metallspiralschlauch, 1250 mm
■ Anschlüsse: ½" Konus x ½"
Metal shower hose, 1250 mm
■ connections: ½" conical x ½"

A	B	C	D	E
42,-	168,-	214,-	233,-	359,-
F	G	H	I	L
189,-	208,-	391,-	418,-	449,-



649.13.342 Metallspiralschlauch, 2000 mm
■ Anschlüsse: M 15x1 x ½"
(für WFB)
Metal shower hose, 2000 mm
■ connections: M 15x1 x ½"
for tub/shower mixer deck mounted

A	B	C	D	E
86,-	218,-	278,-	303,-	457,-
F	G	H	I	L
286,-	298,-	499,-	564,-	564,-

KÜCHENBATTERIEN | KITCHEN TAPS



Oberflächen | colours

Folgende Oberflächen sind bei dieser Serie möglich |
The following colours are possible with this collection

chrom	chrome	[.000]	PG A
silbernickel	polished nickel	[.035]	PG B
nerz	mink	[.095]	PG C
nickel matt	satin nickel	[.036]	PG C
edelmessing	sunshine	[.040]	PG D
platin	platinum	[.065]	PG D
edelmessing matt	sunshine matt	[.041]	PG E
gold matt	gold matt	[.021]	PG E
platin matt	platinum matt	[.066]	PG E
nerz matt	mink matt	[.096]	PG F
schwarz matt	black matt	[.092]	PG G
weiß matt	white matt	[.052]	PG G
bronze	bronze	[.011]	PG H
gold	gold	[.020]	PG I
roségold	rosegold	[.022]	PG L
roségold matt	rosegold matt	[.023]	PG L

Andere Oberflächen auf Anfrage |
Different colours on request

Auf Anfrage können wir Produkte von Drittanbietern auch gerne passend zu unseren Oberflächen veredeln (vorbehaltlich der Eignungsprüfung) | Third-party products may be plated matching to our colours on request (subject to valuation of suitability)

Modernes Design
| Contemporary design

ab Seite | from page 246

Klassisches Design
| Classic design

ab Seite | from page 247

KÜCHENBATTERIEN KITCHEN TAPS

Maßzeichnungen unter www.joerger.de - Menü SERVICE.
Technical specifications under www.joerger.de - menu SERVICE.

A chrom chrome	[.000]	E platin matt platinum matt	[.066]
B silbernickel polished nickel	[.035]	F nerz matt milk matt	[.096]
C nerz milk	[.095]	G schwarz-matt black matt	[.092]
C nickel matt satin nickel	[.036]	G weiß-matt white matt	[.052]
D edelmessing sunshine	[.040]	H bronze bronze	[.011]
D platin platinum	[.065]	I gold gold	[.020]
E edelmess.matt sunshine matt	[.041]	L roségold rosegold	[.022]
E gold matt gold matt	[.021]	L roségold matt rosegold matt	[.023]

	619.10.650 Spültisch 1-Hand Batterie Serie CHARLESTON ROYAL <ul style="list-style-type: none"> runde, serienbezogene Rosette Ausladung 205 mm; Höhe 465 mm schwenkbarer Auslauf Kartusche mit keramischen Scheiben Metallschlauch, Luftsprudler M24 x 1 Pendlerbrause mit Edelstahlfeder Umschalter Auslauf/Brause 2 flexible Druckschläuche 600 mm x M10x1 x ø10 mm 	Single lever sink mixer Series CHARLESTON ROYAL <ul style="list-style-type: none"> round, collection-related escutcheon projection 205 mm, height 465 mm swivelling spout cartridge with ceramic discs metal hose, aerator M24 x 1 moveable shower/stainless steel spring diverter spout/shower 2 flexible hoses 600 mm x M10x1 x ø10 mm 	<table border="1"> <tr><th>A</th><th>B</th><th>C</th><th>D</th><th>E</th></tr> <tr><td>773,-</td><td>1.009,-</td><td>1.126,-</td><td>1.261,-</td><td>1.545,-</td></tr> <tr><th>F</th><th>G</th><th>H</th><th>I</th><th>L</th></tr> <tr><td>1.392,-</td><td>1.398,-</td><td>1.498,-</td><td>1.705,-</td><td>2.480,-</td></tr> </table>	A	B	C	D	E	773,-	1.009,-	1.126,-	1.261,-	1.545,-	F	G	H	I	L	1.392,-	1.398,-	1.498,-	1.705,-	2.480,-
	A	B	C	D	E																		
	773,-	1.009,-	1.126,-	1.261,-	1.545,-																		
F	G	H	I	L																			
1.392,-	1.398,-	1.498,-	1.705,-	2.480,-																			

649.10.088 Rohrverlängerung, Höhe 50 mm <ul style="list-style-type: none"> für 619.10.650 	Body extension, height 50 mm <ul style="list-style-type: none"> for 619.10.650 	<table border="1"> <tr><th>A</th><th>B</th><th>C</th><th>D</th><th>E</th></tr> <tr><td>218,-</td><td>316,-</td><td>355,-</td><td>398,-</td><td>469,-</td></tr> <tr><th>F</th><th>G</th><th>H</th><th>I</th><th>L</th></tr> <tr><td>436,-</td><td>368,-</td><td>492,-</td><td>576,-</td><td>992,-</td></tr> </table>	A	B	C	D	E	218,-	316,-	355,-	398,-	469,-	F	G	H	I	L	436,-	368,-	492,-	576,-	992,-
A	B	C	D	E																		
218,-	316,-	355,-	398,-	469,-																		
F	G	H	I	L																		
436,-	368,-	492,-	576,-	992,-																		

	634.10.650 Spültisch 1-Hand Batterie Serie CHARLESTON SQUARE <ul style="list-style-type: none"> quadratische, serienbezogene Rosette Ausladung 205 mm; Höhe 465 mm schwenkbarer Auslauf Kartusche mit keramischen Scheiben Metallschlauch, Luftsprudler M24 x 1 Pendlerbrause mit Edelstahlfeder Umschalter Auslauf/Brause 2 flexible Druckschläuche 600 mm x M10x1 x ø10 mm 	Single lever sink mixer Series CHARLESTON SQUARE <ul style="list-style-type: none"> square, collection-related escutcheon projection 205 mm, height 465 mm swivelling spout cartridge with ceramic discs metal hose, aerator M24 x 1 moveable shower/stainless steel spring diverter spout/shower 2 flexible hoses 600 mm x M10x1 x ø10 mm 	<table border="1"> <tr><th>A</th><th>B</th><th>C</th><th>D</th><th>E</th></tr> <tr><td>819,-</td><td>1.019,-</td><td>1.170,-</td><td>1.349,-</td><td>1.592,-</td></tr> <tr><th>F</th><th>G</th><th>H</th><th>I</th><th>L</th></tr> <tr><td>1.392,-</td><td>1.396,-</td><td>1.498,-</td><td>1.817,-</td><td>2.648,-</td></tr> </table>	A	B	C	D	E	819,-	1.019,-	1.170,-	1.349,-	1.592,-	F	G	H	I	L	1.392,-	1.396,-	1.498,-	1.817,-	2.648,-
	A	B	C	D	E																		
	819,-	1.019,-	1.170,-	1.349,-	1.592,-																		
F	G	H	I	L																			
1.392,-	1.396,-	1.498,-	1.817,-	2.648,-																			

649.10.088 Rohrverlängerung, Höhe 50 mm <ul style="list-style-type: none"> für 634.10.650 	Body extension, height 50 mm <ul style="list-style-type: none"> for 634.10.650 	<table border="1"> <tr><th>A</th><th>B</th><th>C</th><th>D</th><th>E</th></tr> <tr><td>218,-</td><td>316,-</td><td>355,-</td><td>398,-</td><td>469,-</td></tr> <tr><th>F</th><th>G</th><th>H</th><th>I</th><th>L</th></tr> <tr><td>436,-</td><td>368,-</td><td>492,-</td><td>576,-</td><td>992,-</td></tr> </table>	A	B	C	D	E	218,-	316,-	355,-	398,-	469,-	F	G	H	I	L	436,-	368,-	492,-	576,-	992,-
A	B	C	D	E																		
218,-	316,-	355,-	398,-	469,-																		
F	G	H	I	L																		
436,-	368,-	492,-	576,-	992,-																		

	619.10.680 Spültisch 1-Hand Batterie Serie CHARLESTON ROYAL <ul style="list-style-type: none"> runde, serienbezogene Rosette Ausladung 230 mm; Höhe 295 mm schwenkbarer Auslauf Kartusche mit keramischen Scheiben Luftsprudler M18 x 1 2 flexible Druckschläuche 600 mm x M10x1 x ø10 mm 	Single lever sink mixer Series CHARLESTON ROYAL <ul style="list-style-type: none"> round, collection-related escutcheon projection 230 mm, height 295 mm swivelling spout cartridge with ceramic discs aerator M18 x 1 2 flexible hoses 600 mm x M10x1 x ø10 mm 	<table border="1"> <tr><th>A</th><th>B</th><th>C</th><th>D</th><th>E</th></tr> <tr><td>534,-</td><td>692,-</td><td>805,-</td><td>905,-</td><td>1.110,-</td></tr> <tr><th>F</th><th>G</th><th>H</th><th>I</th><th>L</th></tr> <tr><td>947,-</td><td>1.044,-</td><td>1.120,-</td><td>1.271,-</td><td>1.948,-</td></tr> </table>	A	B	C	D	E	534,-	692,-	805,-	905,-	1.110,-	F	G	H	I	L	947,-	1.044,-	1.120,-	1.271,-	1.948,-
	A	B	C	D	E																		
	534,-	692,-	805,-	905,-	1.110,-																		
F	G	H	I	L																			
947,-	1.044,-	1.120,-	1.271,-	1.948,-																			

	634.10.680 Spültisch 1-Hand Batterie Serie CHARLESTON SQUARE <ul style="list-style-type: none"> quadratische, serienbezogene Rosette Ausladung 230 mm; Höhe 295 mm schwenkbarer Auslauf Kartusche mit keramischen Scheiben Luftsprudler M18 x 1 2 flexible Druckschläuche 600 mm x M10x1 x ø10 mm 	Single lever sink mixer Series CHARLESTON SQUARE <ul style="list-style-type: none"> square, collection-related escutcheon projection 230 mm, height 295 mm swivelling spout cartridge with ceramic discs aerator M18 x 1 2 flexible hoses 600 mm x M10x1 x ø10 mm 	<table border="1"> <tr><th>A</th><th>B</th><th>C</th><th>D</th><th>E</th></tr> <tr><td>552,-</td><td>709,-</td><td>854,-</td><td>993,-</td><td>1.216,-</td></tr> <tr><th>F</th><th>G</th><th>H</th><th>I</th><th>L</th></tr> <tr><td>1.060,-</td><td>1.058,-</td><td>1.132,-</td><td>1.393,-</td><td>2.030,-</td></tr> </table>	A	B	C	D	E	552,-	709,-	854,-	993,-	1.216,-	F	G	H	I	L	1.060,-	1.058,-	1.132,-	1.393,-	2.030,-
	A	B	C	D	E																		
	552,-	709,-	854,-	993,-	1.216,-																		
F	G	H	I	L																			
1.060,-	1.058,-	1.132,-	1.393,-	2.030,-																			

KÜCHENBATTERIEN KITCHEN TAPS

Maßzeichnungen unter www.joerger.de - Menü SERVICE.
Technical specifications under www.joerger.de - menu SERVICE.

A chrom chrome	[.000]	E platin matt platinum matt	[.066]
B silbernickel polished nickel	[.035]	F nerz matt milk matt	[.096]
C nerz milk	[.095]	G schwarz-matt black matt	[.092]
C nickel matt satin nickel	[.036]	G weiß-matt white matt	[.052]
D edelmessing sunshine	[.040]	H bronze bronze	[.011]
D platin platinum	[.065]	I gold gold	[.020]
E edelmess.matt sunshine matt	[.041]	L roségold rosegold	[.022]
E gold matt gold matt	[.021]	L roségold matt rosegold matt	[.023]

	615.10.680 Spültisch 1-Hand Batterie Serie CHARLESTON	Single lever sink mixer Series CHARLESTON ROYAL	A	B	C	D	E	
	<ul style="list-style-type: none"> ■ Ausladung 210 mm; Höhe 265 mm ■ schwenkbarer Auslauf ■ Kartusche mit keramischen Scheiben ■ Luftsprudler M24 x 1 ■ 2 flexible Druckschläuche 600 mm x M10x1 x ø10 mm 	<ul style="list-style-type: none"> ■ projection 210 mm, height 265 mm ■ swivelling spout ■ cartridge with ceramic discs ■ aerator M24 x 1 ■ 2 flexible hoses 600 mm x M10x1 x ø10 mm 	516,-	726,-	889,-	1.000,-	1.225,-	
			F	G	H	I	L	
				1.069,-	1.029,-	1.319,-	1.404,-	2.047,-

	627.10.680 Spültisch 1-Hand Batterie Serie EMPIRE ROYAL	Single lever sink mixer Series EMPIRE ROYAL	A	B	C	D	E	
	<ul style="list-style-type: none"> ■ Ausladung 230 mm; Höhe 315 mm ■ schwenkbarer Auslauf ■ Kartusche mit keramischen Scheiben ■ Luftsprudler M16,5 x 1 ■ 2 flexible Druckschläuche 600 mm x M10x1 x ø10 mm 	<ul style="list-style-type: none"> ■ projection 230 mm, height 315 mm ■ swivelling spout ■ cartridge with ceramic discs ■ aerator M16,5 x 1 ■ 2 flexible hoses 600 mm x M10x1 x ø10 mm 	767,-	928,-	1.203,-	1.354,-	1.659,-	
			F	G	H	I	L	
				1.477,-	1.219,-	1.416,-	1.902,-	2.772,-

	109.10.680 Spültisch 1-Hand Batterie Serie DELPHI	Single lever sink mixer Series DELPHI	A	B	C	D	E	
	<ul style="list-style-type: none"> ■ Ausladung 245 mm; Höhe 250 mm ■ schwenkbarer Auslauf ■ Kartusche mit keramischen Scheiben ■ Luftsprudler M24 x 1 ■ 2 flexible Druckschläuche 600 mm x M10x1 x ø10 mm 	<ul style="list-style-type: none"> ■ projection 245 mm, height 250 mm ■ swivelling spout ■ cartridge with ceramic discs ■ aerator M24 x 1 ■ 2 flexible hoses 600 mm x M10x1 x ø10 mm 	528,-	681,-	726,-	818,-	963,-	
			F	G	H	I	L	
				885,-	939,-	1.025,-	1.241,-	1.854,-

	109.10.620 Spültisch 1-Loch Batterie Serie DELPHI	1-hole sink mixer Series DELPHI	A	B	C	D	E	
	<ul style="list-style-type: none"> ■ Ausladung 245 mm; Höhe 230 mm ■ schwenkbarer Auslauf ■ 2 keramische Oberteile ½" ■ Luftsprudler M24 x 1 ■ 2 flexible Druckschläuche 600 mm x M10x1 x ø10 mm 	<ul style="list-style-type: none"> ■ projection 245 mm, height 230 mm ■ swivelling spout ■ 2 ceramic internal upper parts ½" ■ aerator M24 x 1 ■ 2 flexible hoses 600 mm x M10x1 x ø10 mm 	588,-	742,-	810,-	912,-	1.074,-	
			F	G	H	I	L	
				979,-	938,-	1.035,-	1.384,-	2.018,-

	109.10.640 Spültisch 1-Loch Batterie Serie DELPHI	1-hole sink mixer Series DELPHI	A	B	C	D	E	
	<ul style="list-style-type: none"> ■ Ausladung 190 mm; Höhe 300 mm ■ schwenkbarer Auslauf ■ 2 keramische Oberteile ½" ■ Luftsprudler M22 x 1 ■ 2 flexible Druckschläuche 600 mm x M10x1 x ø10 mm 	<ul style="list-style-type: none"> ■ projection 190 mm, height 300 mm ■ swivelling spout ■ 2 ceramic internal upper parts ½" ■ aerator M22 x 1 ■ 2 flexible hoses 600 mm x M10x1 x ø10 mm 	484,-	595,-	665,-	747,-	881,-	
			F	G	H	I	L	
				819,-	872,-	962,-	1.135,-	1.789,-

	629.10.620 Spültisch 1-Loch Batterie Serie 1909	1-hole sink mixer Series 1909	A	B	C	D	E	
	<ul style="list-style-type: none"> ■ Ausladung 245 mm; Höhe 240 mm ■ schwenkbarer Auslauf ■ 2 keramische Oberteile ½" ■ Luftsprudler M22 x 1 ■ 2 flexible Druckschläuche 600 mm x M10x1 x ø10 mm 	<ul style="list-style-type: none"> ■ projection 245 mm, height 240 mm ■ swivelling spout ■ 2 ceramic internal upper parts ½" ■ aerator M22 x 1 ■ 2 flexible hoses 600 mm x M10x1 x ø10 mm 	588,-	676,-	810,-	912,-	1.074,-	
			F	G	H	I	L	
				996,-	956,-	1.038,-	1.384,-	2.018,-

KÜCHENBATTERIEN KITCHEN TAPS

Maßzeichnungen unter www.joerger.de - Menü SERVICE.
Technical specifications under www.joerger.de - menu SERVICE.

A chrom chrome	[.000]	E platin matt platinum matt	[.066]
B silbernickel polished nickel	[.035]	F nerz matt mink matt	[.096]
C nerz mink	[.095]	G schwarz-matt black matt	[.092]
C nickel matt satin nickel	[.036]	G weiß-matt white matt	[.052]
D edelmessing sunshine	[.040]	H bronze bronze	[.011]
D platin platinum	[.065]	I gold gold	[.020]
E edelmess.matt sunshine matt	[.041]	L roségold rosegold	[.022]
E gold matt gold matt	[.021]	L roségold matt rosegold matt	[.023]



629.20.640 Spültisch Brücken 2-Loch Batterie
Serie 1909

- Ausladung 190 mm; Höhe 268 mm
- schwenkbarer Auslauf
- 2 keramische Oberteile 1/2"
- Luftsprudler M22 x 1
- Stichmaß 150 mm

2-hole sink mixer
Series 1909

- projection 190 mm, height 268 mm
- swivelling spout
- 2 ceramic internal upper parts 1/2"
- aerator M22 x 1
- center distance 150 mm

A	B	C	D	E
628,-	787,-	874,-	984,-	1.159,-
F	G	H	I	L
1.079,-	1.092,-	1.252,-	1.493,-	2.428,-

SANITÄRKERAMIK | SANITARY CERAMIC



Delphi

ab Seite | from page 250



Scala II

ab Seite | from page 254

Symphonie II

ab Seite | from page 258

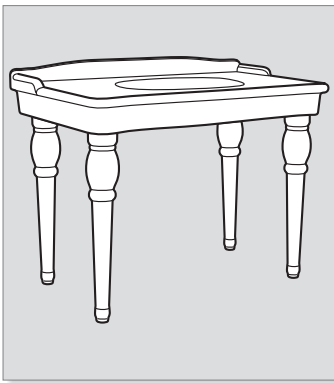
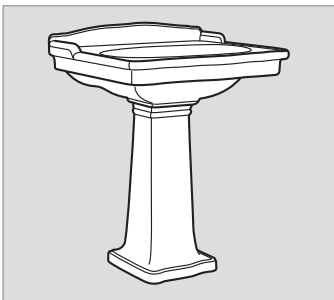
DELPHI

				A	D F	I	
			.100 weiß white	.195 walnuß walnut	.000 chrom chrome	.040 edelmessing sunshine	.020 gold gold
	109.51.010	Waschtisch 112 x 64 cm, für 1-Loch	1.456,-				
	109.51.030	für 3-Loch	1.456,-				
	109.56.000	Keramikfuß, für Waschtisch 112 cm 2 oder 4 Keramikfüße möglich, Preis pro Stück	385,-				
	109.54.010	Waschtisch 94 x 59 cm, für 1-Loch	1.435,-				
	109.54.030	für 3-Loch	1.435,-				
109.56.000	Keramikfuß, für Waschtisch 94 cm 2 Keramikfüße möglich, Preis pro Stück	385,-					
199.50.000	Befestigungsset für Waschtisch			13,-			
	109.50.010	Waschtisch 69 x 56 cm, für 1-Loch	821,-				
	109.50.030	für 3-Loch	821,-				
	109.55.000	Standsäule für Waschtisch 69 cm	369,-				
	199.50.000	Befestigungsset für Waschtisch			13,-		
	109.60.000	Tiefspülklosett Abgang innen senkrecht	642,-				
	109.61.000	Tiefspülklosett Abgang außen waagrecht	642,-				
	109.75.000	Klosettsitz mit Deckel. Scharniere unbedingt separat bestellen. benötigt	221,-	334,-			
	199.75.007	Satz Scharniere zu Klosettsitz			66,-	122,-	180,-
	109.66.000	Tiefspülklosett zu Klosettkombination Abgang innen senkrecht	699,-				
	109.67.000	Tiefspülklosett zu Klosettkombination Abgang außen waagrecht	699,-				
	109.68.000	Spülkasten zu Klosettkombination Zulauf seitlich, ohne Innengarnitur benötigt	376,-				
	199.63.000	Innengarnitur mit Druckknopf und STOP-Einrichtung			238,-	334,-	366,-
	109.75.000	Klosettsitz mit Deckel. Scharniere unbedingt separat bestellen. benötigt	221,-	334,-			
	199.75.007	Satz Scharniere zu Klosettsitz			66,-	122,-	180,-
	199.69.001	Befestigungsset für Tiefspülklosett			18,-	69,-	92,-
	109.80.010	Stand-Bidet, für 1-Loch	689,-				
109.80.030	für 3-Loch	689,-					
199.69.001	Befestigungsset für Bidet			18,-	69,-	92,-	

DELPHI

A chrom chrome	[.000]	I platin matt platinum mat	[.066]
D nerz milk	[.095]	II bronze bronze	[.011]
D edelmessing sunshine	[.040]	I gold gold	[.020]
F edelmess.matt sunshine mat	[.041]	I weiss white	[.050]
F platin platinum	[.065]		

Washbasin 112 x 64 cm, for 1-hole
for 3-hole

Ceramic foot, for washbasin 112 cm
2 or 4 ceramic feet possible, price per piece

Washbasin 94 x 59 cm, for 1-hole
for 3-hole

Ceramic foot, for washbasin 112 cm
2 or 4 ceramic feet possible, price per piece

Fixing set
for washbasin

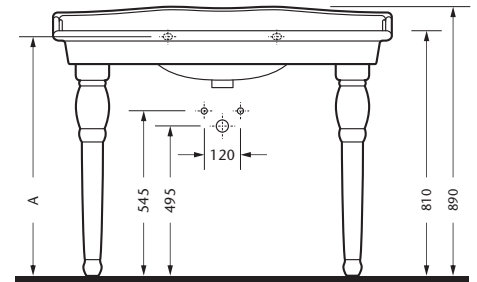
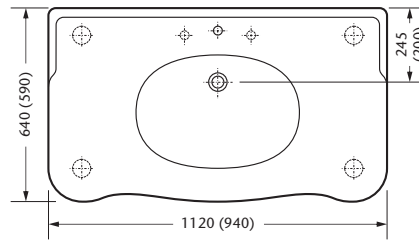

Maß A muß vor Ort ermittelt werden.

Washbasin 69 x 56 cm, for 1-hole
for 3-hole

Pedestal
for washbasin 69 cm

Fixing set
for washbasin

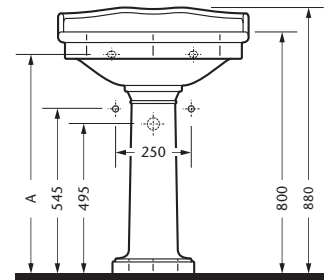
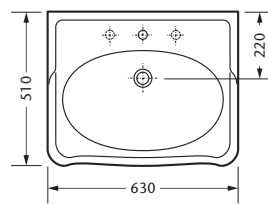

Maß A muß vor Ort ermittelt werden.

W.C. pan
floor outlet

W.C. pan
wall outlet

Toilet seat with lid
Please order hinges separately. **required**

Set of hinges
for toilet seat

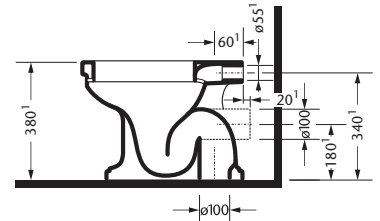
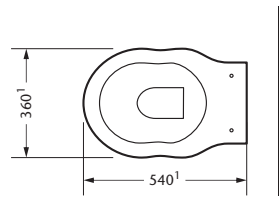

Auf Wunsch sind Klosettsitze auch mit Soft-Close erhältlich.
On request, toilet seats are also available with Soft-Close.

Close coupled w.c. pan
floor outlet

Close coupled w.c. pan
wall outlet

Cistern, for close coupled w.c.
lateral inlet, without mechanism **required**

Mechanism
with push button and STOP-unit

Toilet seat with lid
Please order hinges separately. **required**

Set of hinges
for toilet seat

Fixing set
for w.c. pan

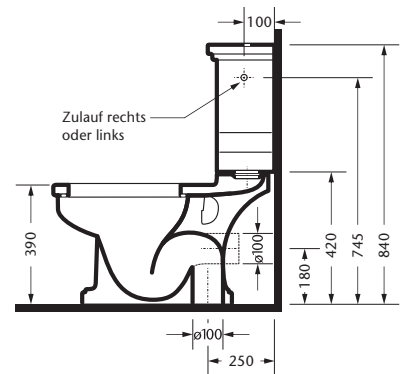
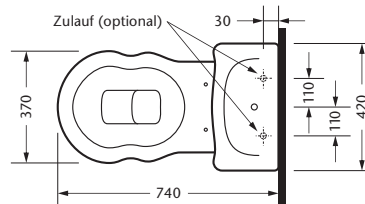

Auf Wunsch sind Klosettsitze auch mit Soft-Close erhältlich.
On request, toilet seats are also available with Soft-Close.

Bidet, for 1-hole
for 3-hole

Fixing set
for bidet

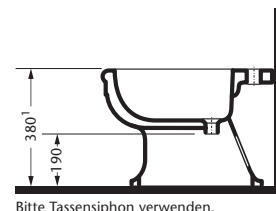
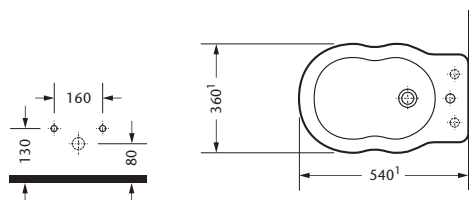

Bitte Tassensiphon verwenden.

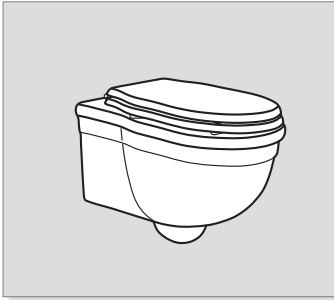
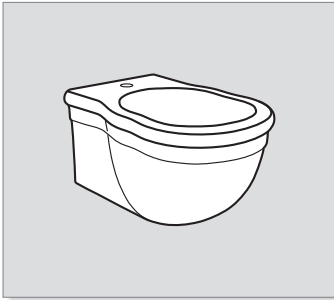
			A	D F	I
		.100 weiß white	.000 chrom chrome	.040 edelmessing sunshine	.020 gold gold
	109.62.000 Wand-Tiefspülklosett	634,-			
	109.74.010 Klosettsitz mit Deckel. Scharniere unbedingt separat bestellen. benötigt	185,-			
	199.72.000 Satz Scharniere zu Klosettsitz		79,-	146,-	217,-
	109.82.000 Wand-Bidet für 1-Loch	634,-			

A chrom | chrome [000]
 D nerz | mink [095]
 D edelmessing | sunshine [040]
 F edelmess.matt | sunshine mat [041]
 F platin | platinum [065]

I platin matt | platinum mat [066]
 I bronze | bronze [011]
 I gold | gold [020]
 I weiss | white [050]

W.C. pan, suspended

Toilet seat with lid

Please order hinges separately.

required

Set of hinges

for toilet seat

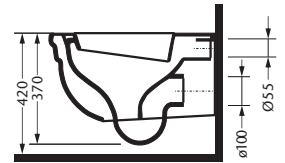
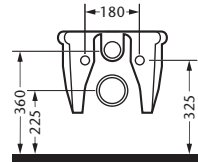
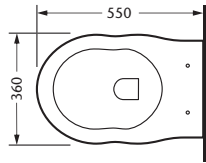



Auf Wunsch sind Klosettsitze auch mit Soft-Close erhältlich.
 On request, toilet seats are also available with Soft-Close.

Bidet, suspended

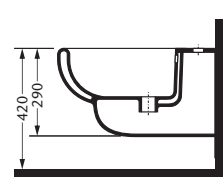
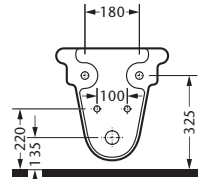
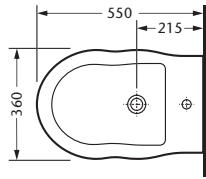
for 1-hole

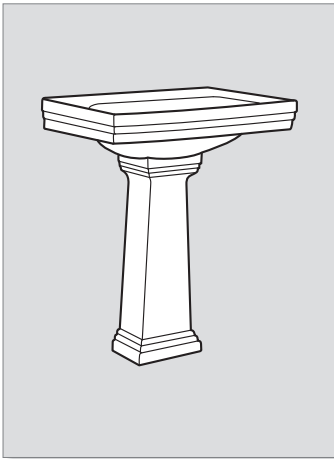

SCALA II

			.100	.190	A	D F	I
			weiß white	mahagoni mahagony	.000 chrom chrome	.040 edelmessing sunshine	.020 gold gold
	133.50.010	Waschtisch 64 x 48 cm, für 1-Loch	782,-				
	133.50.030	Waschtisch 64 x 48 cm, für 3-Loch	782,-				
	133.55.000	Standsäule für Waschtisch 64 cm	620,-				
	133.52.010	Handwaschbecken für 1-Loch	634,-				
	133.52.030	Handwaschbecken für 3-Loch	634,-				
	199.50.000	Befestigungsset für Waschtisch u. Handwaschbecken			13,-		
	133.66.000	Tiefspülklosett zu Klosettkombination Abgang innen senkrecht	725,-				
	133.67.000	Tiefspülklosett zu Klosettkombination Abgang außen waagrecht	725,-				
	133.68.000	Spülkasten zu Klosettkombination Zulauf seitlich, ohne Innengarnitur benötigt	475,-				
	199.63.006	Innengarnitur mit Druckknopf und STOP-Einrichtung			238,-	334,-	366,-
	112.75.000	Klosettsitz mit Deckel. Scharniere unbedingt separat bestellen. benötigt	221,-	487,-			
	199.75.002	Satz Scharniere zu Klosettsitz 103.75.000			66,-	122,-	180,-
	199.69.002	Befestigungsset für Tiefspülklosett			17,-	68,-	91,-
	133.80.010	Stand-Bidet für 1-Loch	743,-				
	199.69.002	Befestigungsset für Bidet			17,-	68,-	91,-

SCALA II

A chrom chrome	[.000]	I platin matt platinum mat	[.066]
D nerz milk	[.095]	I bronze bronze	[.011]
D edelmessing sunshine	[.040]	I gold gold	[.020]
F edelmess.matt sunshine mat	[.041]	I weiss white	[.050]
F platin platinum	[.065]		

Washbasin 64 x 48 cm, for 1-hole
for 3-hole

Pedestal
for washbasin 64 cm

Mini washbasin 52 x 41 cm, for 1-hole
for 3-hole

Fixing set
for washbasins

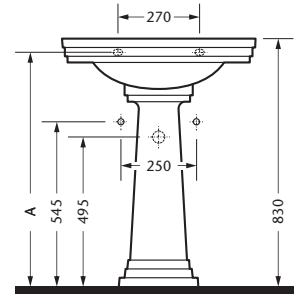
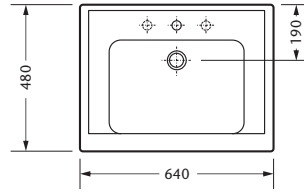
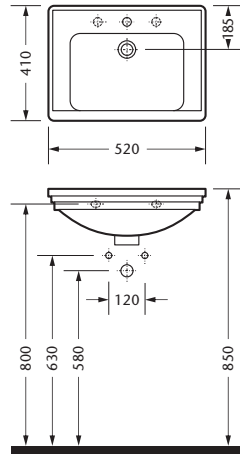

Maß A muß vor Ort ermittelt werden.

Close coupled w.c. pan
floor outlet

Close coupled w.c. pan
wall outlet

Cistern, for close coupled w.c.
lateral inlet, without mechanism **required**

Mechanism
with push button and STOP-unit

Toilet seat with lid
Please order hinges separately. **required**

Set of hinges
for toilet seat

Fixing set
for w.c. pan

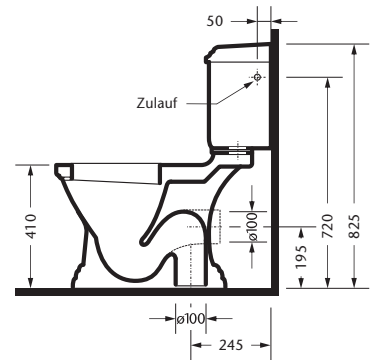
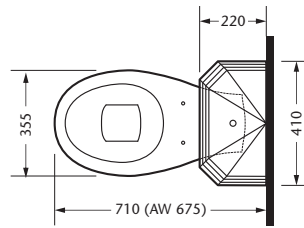

Auf Wunsch sind Klosettsitze auch mit Soft-Close erhältlich.
On request, toilet seats are also available with Soft-Close.

Bidet
for 1-hole

Fixing set
for bidet

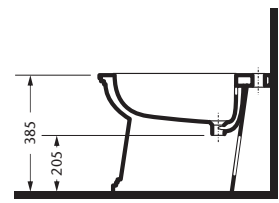
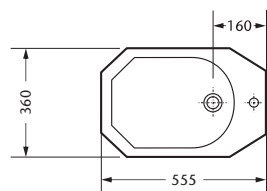
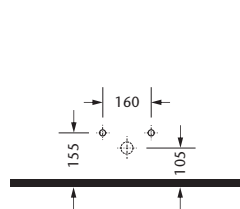

Bitte Tassensiphon verwenden.

SCALA II

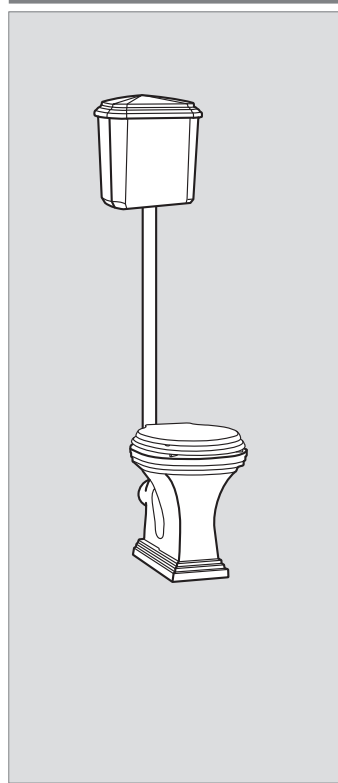

			A	D	F	I	
		.100 weiß white	.190 mahagoni mahogany	.000 chrom chrome	.040 edelmessing sunshine	.065 platin platinum	.020 gold gold
133.61.000 Tiefspülklosett Abgang außen waagrecht	861,-						
112.75.000 Klosettsitz mit Deckel. Scharniere unbedingt separat bestellen.	221,-	487,-					
benötigt							
199.75.002 Satz Scharniere zu Klosettsitz			66,-	122,-	122,-	180,-	
199.69.002 Befestigungsset für Tiefspülklosett			17,-	68,-	68,-	91,-	
133.65.000 Spülkasten, hochhängend Zulauf seitlich, ohne Innengarnitur	589,-						
benötigt							
199.63.017 Innengarnitur zu Spülkasten, hochhängend			165,-				
benötigt							
199.63.026 Rohr zu Spülkasten, hochhängend mit Befestigungsring, Dichtung und Zugkette			521,-	1.467,-	2.483,-	2.721,-	
benötigt							.050 weiß white
199.63.025 Aufhängekonsole zu Spülkasten							495,-

SCALA II

A chrom chrome	[.000]	I platin matt platinum mat	[.066]
D nerz milk	[.095]	I bronze bronze	[.011]
D edelmessing sunshine	[.040]	I gold gold	[.020]
F edelmess.matt sunshine mat	[.041]	I weiss white	[.050]
F platin platinum	[.065]		

W.C. pan
wall outlet

Toilet seat with lid
Please order hinges separately.

required

Set of hinges
for toilet seat

Fixing set
for w.c. pan

Cistern, high level
lateral inlet, without mechanism

required

Mechanism with chain
for high level cistern

required

Pipe for high level cistern
with fixing ring and gasket

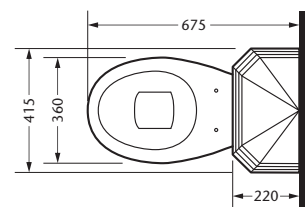
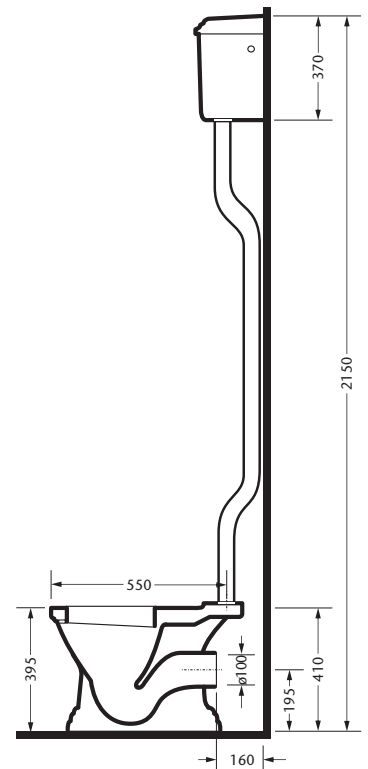

required

Fixing console, white
for high level cistern

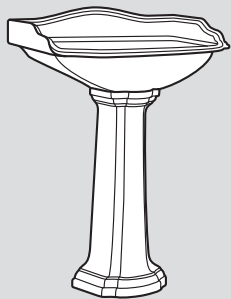
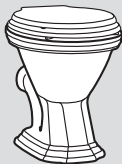

Auf Wunsch sind Klosettsitze auch mit Soft-Close erhältlich.
On request, toilet seats are also available with Soft-Close.

SYMPHONIE II

			.100	.190	A	D F	I
			weiß	mahagoni	.000	.040	.020
			white	mahogany	chrom	edelmessing	gold
	132.50.010	Waschtisch 65 x 50 cm, für 1-Loch	676,-				
	132.50.030	für 3-Loch	676,-				
	132.55.000	Standsäule für Waschtisch 65 cm	437,-				
	132.52.010	Handwaschbecken, für 1-Loch	515,-				
	132.52.030	53 x 37 cm für 3-Loch	515,-				
	199.50.000	Befestigungsset für Waschtisch u. Handwaschbecken			13,-		
	132.61.000	Tiefspülklosett Abgang außen waagrecht	669,-				
	112.75.000	Klosettsitz mit Deckel. Scharniere unbedingt separat bestellen.	221,-	487,-			
	199.75.002	Satz Scharniere zu Klosettsitz			66,-	122,-	180,-
	199.69.002	Befestigungsset für Tiefspülklosett			17,-	68,-	91,-
	132.66.000	Tiefspülklosett zu Klosettkombination Abgang innen senkrecht	745,-				
	132.67.000	Tiefspülklosett zu Klosettkombination Abgang außen waagrecht	745,-				
	132.68.000	Spülkasten zu Klosettkombination Zulauf seitlich, ohne Innengarnitur	464,-				
	199.63.007	Innengarnitur mit Druckknopf und STOP-Einrichtung			238,-	334,-	366,-
	112.75.000	Klosettsitz mit Deckel. Scharniere unbedingt separat bestellen.	221,-	487,-			
	199.75.002	Satz Scharniere zu Klosettsitz			66,-	122,-	180,-
	199.69.002	Befestigungsset für Tiefspülklosett			17,-	68,-	91,-
	132.80.010	Stand-Bidet für 1-Loch	669,-				
	199.69.002	Befestigungsset für Bidet			17,-	68,-	91,-

SYMPHONIE II

A chrom | chrome [000]
 D nerz | nick [095]
 D edelmessing | sunshine [040]
 F edelmess.matt | sunshine mat [041]
 F platin | platinum [065]

I platin matt | platinum mat [066]
 I bronze | bronze [011]
 I gold | gold [020]
 I weiss | white [050]

Washbasin 65 x 50 cm, for 1-hole
for 3-hole

Pedestal
for washbasin 65 cm

Mini washbasin 53 x 37 cm, for 1-hole
for 3-hole

Fixing set
for washbasin

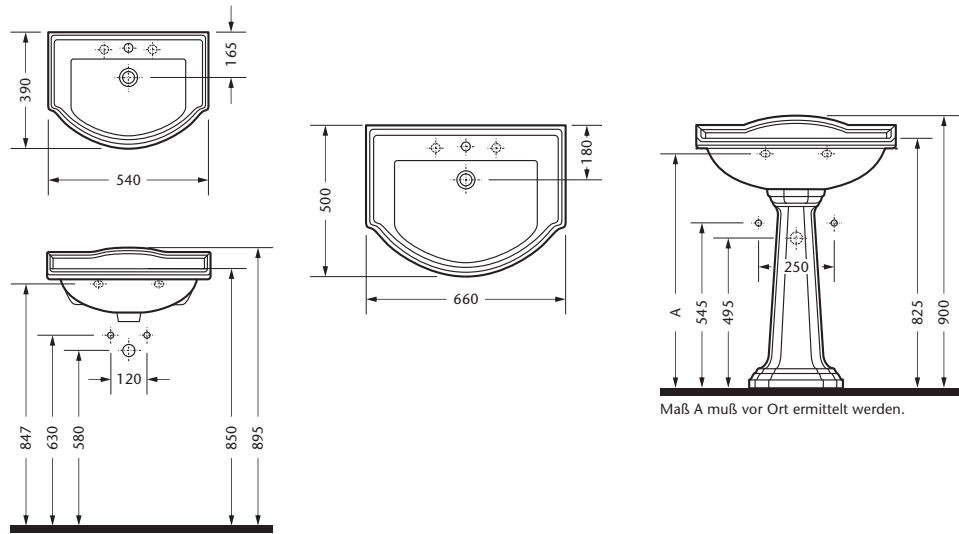

W.C. pan
wall outlet

Toilet seat with lid
Please order hinges separately. **required**

Set of hinges
for toilet seat

Fixing set
for w.c. pan

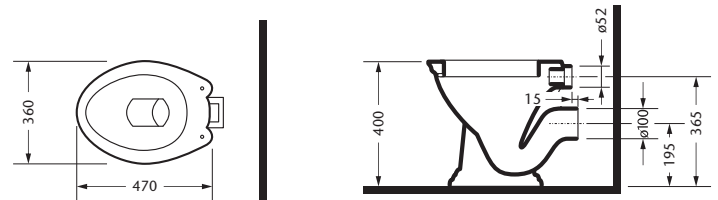

Auf Wunsch sind Klosettsitze auch mit Soft-Close erhältlich.
On request, toilet seats are also available with Soft-Close.

Close coupled w.c. pan
floor outlet

Close coupled w.c. pan
wall outlet

Cistern, for close coupled w.c.
lateral inlet, without mechanism **required**

Mechanism
with push button and STOP-unit

Toilet seat with lid
Please order hinges separately. **required**

Set of hinges
for toilet seat

Fixing set
for w.c. pan

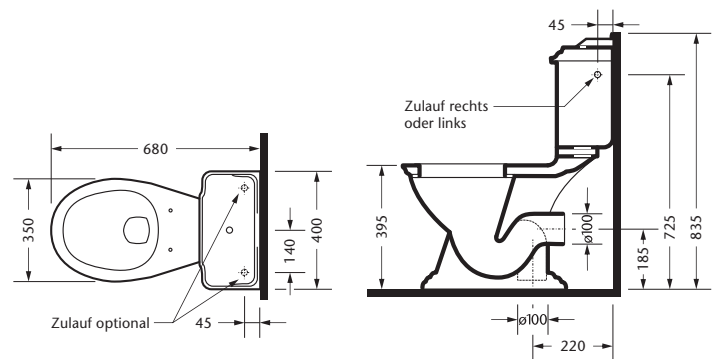

Auf Wunsch sind Klosettsitze auch mit Soft-Close erhältlich.
On request, toilet seats are also available with Soft-Close.

Bidet
for 1-hole

Fixing set
for bidet

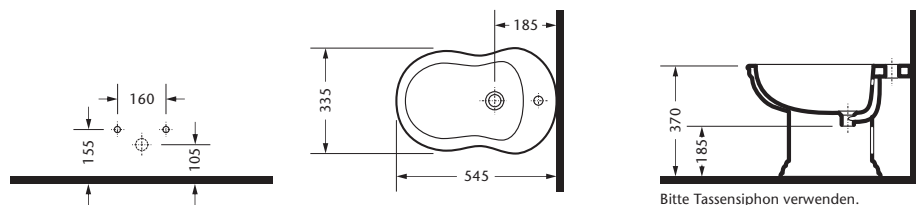

SYMPHONIE II

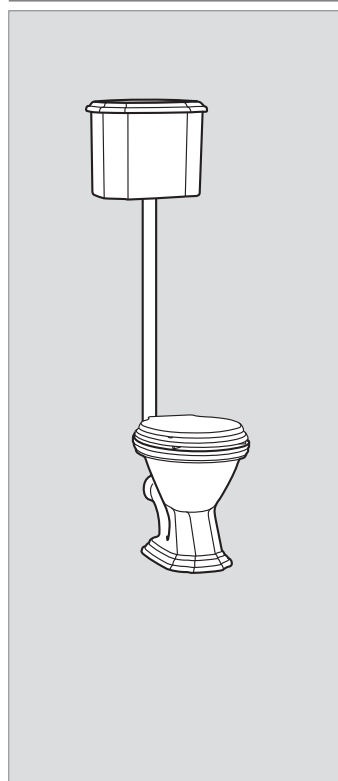

			A	D	F	I	
		.100 weiß white	.190 mahagoni mahagony	.000 chrom chrome	.040 edelmessing sunshine	.065 platin platinum	.020 gold gold
132.61.000	Tiefspülklosett Abgang außen waagrecht						
		669,-					
112.75.000	Klosettsitz mit Deckel. Scharniere unbedingt separat bestellen.	221,-	487,-				
	benötigt						
199.75.002	Satz Scharniere zu Klosettsitz			66,-	122,-	122,-	180,-
199.69.002	Befestigungsset für Tiefspülklosett			17,-	68,-	68,-	91,-
132.65.000	Spülkasten, hochhängend Zulauf seitlich, ohne Innengarnitur	550,-					
	benötigt						
199.63.014	Innengarnitur zu Spülkasten, hochhängend			165,-			
	benötigt						
199.63.024	Rohr zu Spülkasten, hochhängend mit Befestigungsring, Dichtung und Zugkette			521,-	1.467,-	2.483,-	2.721,-
	benötigt						.050 weiß white
199.63.025	Aufhängekonsole, weiß zu Spülkasten						495,-

SYMPHONIE II

A chrom chrome	[.000]	I platin matt platinum mat	[.066]
D nerz milk	[.095]	I bronze bronze	[.011]
D edelmessing sunshine	[.040]	I gold gold	[.020]
F edelmess.matt sunshine mat	[.041]	I weiss white	[.050]
F platin platinum	[.065]		

W.C. pan
wall outlet

Toilet seat with lid
Please order hinges separately.

required

Set of hinges
for toilet seat

Fixing set
for w.c. pan

Cistern, high level
lateral inlet, without mechanism

required

Mechanism with chain
for high level cistern

required

Pipe for high level cistern
with fixing ring and gasket

required

Fixing console, white
for high level cistern

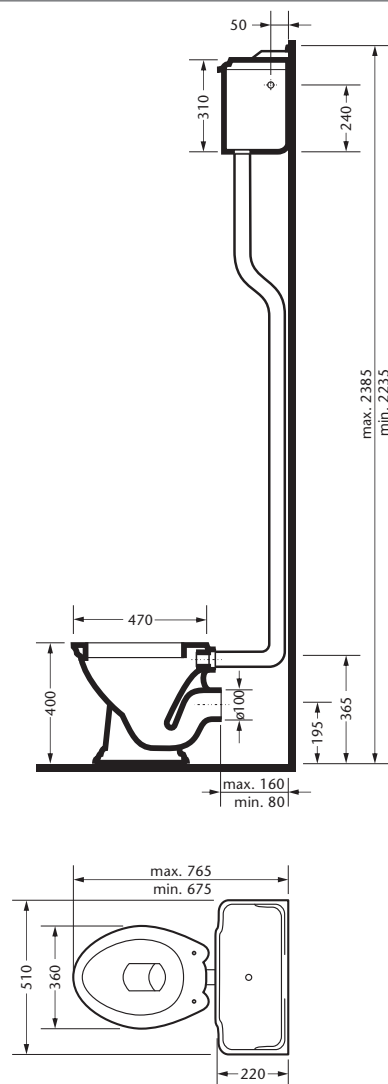

Auf Wunsch sind Klosettsitze auch mit Soft-Close erhältlich.
On request, toilet seats are also available with Soft-Close.





Oberflächen | colours

Folgende Oberflächen sind bei dieser Serie für die Metallteile möglich | The following colours are possible with this collection for the metal parts:

chrom	chrome	[.000] PG A
silbernickel	polished nickel	[.035] PG B
nerz	mink	[.095] PG C
nickel matt	satin nickel	[.036] PG C
edelmessing	sunshine	[.040] PG D
platin	platinum	[.065] PG D
edelmessing matt	sunshine matt	[.041] PG E
gold matt	gold matt	[.021] PG E
platin matt	platinum matt	[.066] PG E
nerz matt	mink matt	[.096] PG F
schwarz matt	black matt	[.092] PG G
weiß matt	white matt	[.052] PG G
bronze	bronze	[.011] PG H
gold	gold	[.020] PG I
roségold	rosegold	[.022] PG L
roségold matt	rosegold matt	[.023] PG L

Andere Oberflächen auf Anfrage | Different colours on request

Auf Anfrage können wir Produkte von Drittanbietern auch gerne passend zu unseren Oberflächen veredeln (vorbehaltlich der Eignungsprüfung) | Third-party products may be plated matching to our colours on request (subject to valuation of suitability)

DELPHI

ab Seite | from page 264

A chrom chrome	[.000]	E platin matt platinum matt	[.066]
B silbernickel polished nickel	[.035]	F nerz matt mink matt	[.096]
C nerz mink	[.095]	G schwarz-matt black matt	[.092]
C nickel matt satin nickel	[.036]	G weiß-matt white matt	[.052]
D edelmessing sunshine	[.040]	H bronze bronze	[.011]
D platin platinum	[.065]	I gold gold	[.020]
E edelmess.matt sunshine matt	[.041]	L roségold rosegold	[.022]
E gold matt gold matt	[.021]	L roségold matt rosegold matt	[.023]

	109.90.000 Freistehende Wanne 170 x 80 cm <ul style="list-style-type: none"> ■ glasfaserverstärkter Kunststoff ■ durch 2-Schalen-Technik innen und außen glänzend ■ Löwentatzenfüße bitte separat bestellen 	Detached bath tub 170 x 80 cm <ul style="list-style-type: none"> ■ fibre glass plastic ■ shiny surface in- and outside due to 2-mould-technique ■ please order paws separately 	<table border="1"> <tr><td></td><td></td><td></td><td></td><td></td></tr> <tr><td>2.179,-</td><td></td><td></td><td></td><td></td></tr> <tr><td></td><td></td><td></td><td></td><td></td></tr> </table>						2.179,-									
	2.179,-																	

109.95.000 Satz Löwentatzenfüße <ul style="list-style-type: none"> ■ 4 Stück ■ Metallausführung 	Set of paws <ul style="list-style-type: none"> ■ 4 pieces ■ metal version 	<table border="1"> <tr><th>A</th><th>B</th><th>C</th><th>D</th><th>E</th></tr> <tr><td>982,-</td><td>1.398,-</td><td>1.686,-</td><td>1.745,-</td><td>2.287,-</td></tr> <tr><th>F</th><th>G</th><th>H</th><th>I</th><th>L</th></tr> <tr><td>1.949,-</td><td>1.645,-</td><td>2.282,-</td><td>2.819,-</td><td>4.108,-</td></tr> </table>	A	B	C	D	E	982,-	1.398,-	1.686,-	1.745,-	2.287,-	F	G	H	I	L	1.949,-	1.645,-	2.282,-	2.819,-	4.108,-
A	B	C	D	E																		
982,-	1.398,-	1.686,-	1.745,-	2.287,-																		
F	G	H	I	L																		
1.949,-	1.645,-	2.282,-	2.819,-	4.108,-																		

109.15.250 Spezial Ab- und Überlaufgarnitur <ul style="list-style-type: none"> ■ im Stil passender Stopfenverschluß und Kette ■ inkl. Geruchverschluß und Ablaufbogen ■ der Ablaufbogen endet 20 mm über dem fertigen Fußboden 	Special waste fitting <ul style="list-style-type: none"> ■ incl. plug and chain matching the design ■ incl. odor seal and waste pipe ■ the waste pipe ends 20 mm above finished floor 	<table border="1"> <tr><th>A</th><th>B</th><th>C</th><th>D</th><th>E</th></tr> <tr><td>539,-</td><td>879,-</td><td>1.059,-</td><td>1.192,-</td><td>1.339,-</td></tr> <tr><th>F</th><th>G</th><th>H</th><th>I</th><th>L</th></tr> <tr><td>1.229,-</td><td>1.034,-</td><td>1.300,-</td><td>1.485,-</td><td>2.165,-</td></tr> </table>	A	B	C	D	E	539,-	879,-	1.059,-	1.192,-	1.339,-	F	G	H	I	L	1.229,-	1.034,-	1.300,-	1.485,-	2.165,-
A	B	C	D	E																		
539,-	879,-	1.059,-	1.192,-	1.339,-																		
F	G	H	I	L																		
1.229,-	1.034,-	1.300,-	1.485,-	2.165,-																		

	109.20.100 Wannenfüll- und Brausebatterie, mit Garnitur <ul style="list-style-type: none"> ■ 2 keramische Oberteile ½" ■ Umstellung Wanne/Brause ■ Handbrause mit Metallschlauch 1500 mm 	Tube/shower mixer set, incl. shower set <ul style="list-style-type: none"> ■ 2 ceramic internal upper parts ½" ■ diverter spout/shower ■ hand shower with metal hose 1500 mm 	<table border="1"> <tr><th>A</th><th>B</th><th>C</th><th>D</th><th>E</th></tr> <tr><td>876,-</td><td>1.124,-</td><td>1.524,-</td><td>1.715,-</td><td>2.019,-</td></tr> <tr><th>F</th><th>G</th><th>H</th><th>I</th><th>L</th></tr> <tr><td>1.869,-</td><td>1.486,-</td><td>1.796,-</td><td>2.299,-</td><td>2.996,-</td></tr> </table>	A	B	C	D	E	876,-	1.124,-	1.524,-	1.715,-	2.019,-	F	G	H	I	L	1.869,-	1.486,-	1.796,-	2.299,-	2.996,-
	A	B	C	D	E																		
	876,-	1.124,-	1.524,-	1.715,-	2.019,-																		
F	G	H	I	L																			
1.869,-	1.486,-	1.796,-	2.299,-	2.996,-																			

109.15.260 Wasserzufuhrstandrohre ½" <ul style="list-style-type: none"> ■ 2 Stück ■ in Zuleitung im Boden einzuschrauben ■ inkl. Winkelstück zum Anschluß der Wannenfüll- und Brausebatterie ■ Rosetten 	Water supply pipes ½" <ul style="list-style-type: none"> ■ 2 pieces ■ to install in supply in the floor ■ incl. angle for connecting tub/shower mixer ■ escutcheons 	<table border="1"> <tr><th>A</th><th>B</th><th>C</th><th>D</th><th>E</th></tr> <tr><td>888,-</td><td>1.282,-</td><td>1.672,-</td><td>1.882,-</td><td>2.219,-</td></tr> <tr><th>F</th><th>G</th><th>H</th><th>I</th><th>L</th></tr> <tr><td>2.095,-</td><td>1.632,-</td><td>1.952,-</td><td>2.525,-</td><td>3.488,-</td></tr> </table>	A	B	C	D	E	888,-	1.282,-	1.672,-	1.882,-	2.219,-	F	G	H	I	L	2.095,-	1.632,-	1.952,-	2.525,-	3.488,-
A	B	C	D	E																		
888,-	1.282,-	1.672,-	1.882,-	2.219,-																		
F	G	H	I	L																		
2.095,-	1.632,-	1.952,-	2.525,-	3.488,-																		

Empfohlen Recommended 109.15.270 Befestigungsstück <ul style="list-style-type: none"> ■ zur Fixierung der Wasserzufuhrstandrohre an der Ab- und Überlaufgarnitur 	Mounting device <ul style="list-style-type: none"> ■ for attachment of water supply pipes to waste fitting 	<table border="1"> <tr><th>A</th><th>B</th><th>C</th><th>D</th><th>E</th></tr> <tr><td>354,-</td><td>418,-</td><td>503,-</td><td>566,-</td><td>592,-</td></tr> <tr><th>F</th><th>G</th><th>H</th><th>I</th><th>L</th></tr> <tr><td>578,-</td><td>492,-</td><td>522,-</td><td>665,-</td><td>970,-</td></tr> </table>	A	B	C	D	E	354,-	418,-	503,-	566,-	592,-	F	G	H	I	L	578,-	492,-	522,-	665,-	970,-
A	B	C	D	E																		
354,-	418,-	503,-	566,-	592,-																		
F	G	H	I	L																		
578,-	492,-	522,-	665,-	970,-																		

109.10.970 Basatz-Vormontage <ul style="list-style-type: none"> ■ Bodenplatte mit Befestigungsset ■ für Wasserzufuhrstandrohre 109.15.260 	Assembly set for pre-installation <ul style="list-style-type: none"> ■ joint plate with fixing set ■ for water supply pipes 109.15.260 	<table border="1"> <tr><th>A</th><th>B</th><th>C</th><th>D</th><th>E</th></tr> <tr><td>459,-</td><td></td><td></td><td></td><td></td></tr> </table>	A	B	C	D	E	459,-				
A	B	C	D	E								
459,-												

HINWEIS!
An die Wasserzufuhrstandrohre können auch andere Armaturen aus unserem Produktionsprogramm angeschlossen werden.

NOTE!
Water supply pipes are suitable for other mixers from our production line as well.

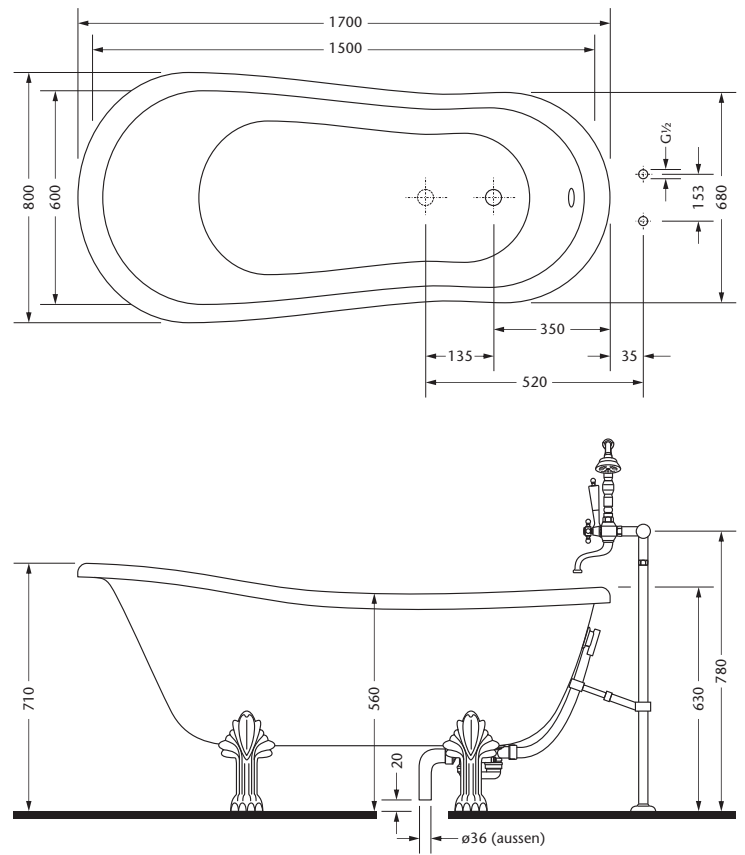

Modelle und technische Details entsprechen bei Druck dem letzten Stand. Technische Konstruktions- und Modellveränderungen im Sinne des Fortschritts behalten wir uns vor. Druckfehler vorbehalten.
 Models and technical details shown are corresponding to the latest version. We reserve the right to technical improvements and/or changes. Subject to printing errors.





Oberflächen | colours

Folgende Oberflächen sind bei dieser Serie möglich |
The following colours are possible with this collection

chrom	chrome	[.000] PG A
silbernickel	polished nickel	[.035] PG B
nerz	mink	[.095] PG C
nickel matt	satin nickel	[.036] PG C
edelmessing	sunshine	[.040] PG D
platin	platinum	[.065] PG D
edelmessing matt	sunshine matt	[.041] PG E
gold matt	gold matt	[.021] PG E
platin matt	platinum matt	[.066] PG E
nerz matt	mink matt	[.096] PG F
schwarz matt	black matt	[.092] PG G
weiß matt	white matt	[.052] PG G
bronze	bronze	[.011] PG H
gold	gold	[.020] PG I
roségold	rosegold	[.022] PG L
roségold matt	rosegold matt	[.023] PG L

Andere Oberflächen auf Anfrage |
Different colours on request

Auf Anfrage können wir Produkte von Drittanbietern auch gerne passend zu unseren Oberflächen veredeln (vorbehaltlich der Eignungsprüfung) | Third-party products may be plated matching to our colours on request (subject to valuation of suitability)

Waschtisch | Washbasin

ab Seite | from page 268

Bidet | Bidet

ab Seite | from page 269

Wanne | Bath tub

ab Seite | from page 270

Dusche | Shower

ab Seite | from page 271

Accessoires | Accessories

ab Seite | from page 277

Maßzeichnungen unter www.joerger.de - Menü SERVICE.
 Technical specifications under www.joerger.de - menu SERVICE.

A chrom chrome	[.000]	E platin matt platinum matt	[.066]
B silbernickel polished nickel	[.035]	F nerz matt mink matt	[.096]
C nerz mink	[.095]	G schwarz-matt black matt	[.092]
C nickel matt satin nickel	[.036]	G weiß-matt white matt	[.052]
D edelmessing sunshine	[.040]	H bronze bronze	[.011]
D platin platinum	[.065]	I gold gold	[.020]
E edelmess.matt sunshine matt	[.041]	L roségold rosegold	[.022]
E gold matt gold matt	[.021]	L roségold matt rosegold matt	[.023]

Waschtisch Batterien | Washbasin mixer

	621.30.300 Waschtisch 3-Loch Batterie 1/2" <ul style="list-style-type: none"> Ausladung 140 mm; Höhe 120 mm 2 Seitenrandventile mit keramischen Oberteilen 1/2" Ablaufventil mit Klickverschluß 1 1/4" empfohlen: 2x 649.15.530 - Kupferrohr 300 mm	Washbasin 3-hole mixer 1/2" <ul style="list-style-type: none"> spout projection 140 mm; height 120 mm 2 side valves with ceramic internal upper parts 1/2" push-open waste 1 1/4" recommended: 2x 649.15.530 - copper tube 300 mm	A	B	C	D	E
			941,-	1.095,-	1.365,-	1.536,-	1.811,-
			F	G	H	I	L
			1.650,-	1.421,-	1.732,-	2.175,-	3.175,-

	621.10.333 Waschtisch 1-Hand Batterie <ul style="list-style-type: none"> Ausladung 140 mm; Höhe 120 mm Kartusche mit ker. Scheiben Ablaufventil mit Klickverschluß 1 1/4" 2 Druckschläuche M10x1 x 450 mm 	Single lever washbasin mixer <ul style="list-style-type: none"> spout projection 140 mm; height 120 mm cartridge with ceramic discs push-open waste 1 1/4" 2 pressure hoses M10x1 x 450 mm 	A	B	C	D	E
			572,-	894,-	999,-	1.068,-	1.389,-
			F	G	H	I	L
			1.250,-	1.101,-	1.324,-	1.546,-	2.512,-

Variante | Alternative

	621.10.334 Waschtisch 1-Hand Batterie <ul style="list-style-type: none"> ohne Ablaufventil 	Single lever washbasin mixer <ul style="list-style-type: none"> without waste 	A	B	C	D	E
			539,-	798,-	879,-	929,-	1.267,-
			F	G	H	I	L
			1.077,-	949,-	1.182,-	1.453,-	2.019,-

	621.10.834 Waschtisch 1-Hand Batterie <ul style="list-style-type: none"> für freistehende Montage Ausladung 200 mm ohne Ablaufgarnitur Standrohr mit Befestigungsflansch Luftsprudler Kartusche mit keramischen Scheiben Höhe gesamt 975 - 1055 mm Höhe bis Luftsprudler 945 - 1025 mm 	Single lever washbasin mixer <ul style="list-style-type: none"> free standing assembly spout projection 200 mm without waste Pillar tube with flange aerator ceramic internal upper part height 975 - 1055 mm aerator height 945 - 1025 mm 	A	B	C	D	E
			1.804,-	2.148,-	3.030,-	3.152,-	4.009,-
			F	G	H	I	L
			3.347,-	2.457,-	3.891,-	4.664,-	4.847,-

Benötigt | Required

	649.10.970 Bausatz-Vormontage <ul style="list-style-type: none"> Bodenplatte mit Befestigungsset zu Fertigmontageset 621.10.834 	Assembly set for pre-installation <ul style="list-style-type: none"> joint plate with fixing set for assembly set 621.10.834 	A				
			549,-				

Wand-Waschtisch 1-Hand Batterien | Single lever wall-washbasin mixer

	621.20.360 Wand-Waschtisch 1-Hand Batterie 1/2", Fertigmontageset <ul style="list-style-type: none"> Wand-Auslauf, Ausladung 200 mm Wandrosette 	Single lever wall washbasin mixer 1/2", assembly set <ul style="list-style-type: none"> wall spout, projection 200 mm escutcheon 	A	B	C	D	E
			625,-	638,-	881,-	992,-	1.411,-
			F	G	H	I	L
			1.171,-	930,-	1.289,-	1.711,-	2.404,-

Benötigt | Required

	649.20.362 Wand-Waschtisch 1-Hand Batterie 1/2", Einbaukörper <ul style="list-style-type: none"> zu Fertigmontageset 623.20.366 Kartusche mit ker. Scheiben 	Single lever wall washbasin mixer 1/2", concealed body <ul style="list-style-type: none"> for assembly set 623.20.366 cartridge with ceramic discs 	A				
			258,-				

ACUBO

Maßzeichnungen unter www.joerger.de - Menü SERVICE.
 Technical specifications under www.joerger.de - menu SERVICE.

A chrom chrome	[.000]	E platin matt platinum matt	[.066]
B silbernickel polished nickel	[.035]	F nerz matt milk matt	[.096]
C nerz milk	[.095]	G schwarz-matt black matt	[.092]
C nickel matt satin nickel	[.036]	G weiß-matt white matt	[.052]
D edelmessing sunshine	[.040]	H bronze bronze	[.011]
D platin platinum	[.065]	I gold gold	[.020]
E edelmess.matt sunshine matt	[.041]	L roségold rosegold	[.022]
E gold matt gold matt	[.021]	L roségold matt rosegold matt	[.023]

Bidet Batterien | Bidet mixer



621.10.111 Bidet 1-Hand Batterie	Single lever bidet mixer
<ul style="list-style-type: none"> ■ Ausladung 128 mm; Höhe 120 mm ■ Kartusche mit ker. Scheiben ■ Perlator schwenkbar - 15 Grad ■ Ablaufventil mit Klickverschluß 1 ¼" ■ 2 Druckschläuche M10x1 x 450 mm 	<ul style="list-style-type: none"> ■ projection 128 mm; height 120 mm ■ cartridge with ceramic discs ■ aerator swiveling - 15 degrees ■ push-open waste 1 ¼" ■ 2 pressure hoses M10x1 x 450 mm

A	B	C	D	E
626,-	916,-	1.090,-	1.227,-	1.502,-
F	G	H	I	L
1.259,-	1.122,-	1.310,-	1.724,-	2.532,-

Zubehör für Waschtisch- und Bidet-Batterien | Supplies for washbasin and bidet mixer



626.12.100 Eckventil ½"	Angle valve ½"
<ul style="list-style-type: none"> ■ Ausladung 100 mm ■ Fettkammer-Innenoberteil ½" ■ Quetschverschraubung ■ Schubrosette 	<ul style="list-style-type: none"> ■ projection 100 mm ■ cartridge ½" ■ compression joint ■ escutcheon

A	B	C	D	E
145,-	196,-	248,-	296,-	448,-
F	G	H	I	L
392,-	265,-	424,-	529,-	698,-



649.15.530 Kupferrohr, 300 mm	Copper tube, 300 mm
<ul style="list-style-type: none"> ■ mit Bördel, für Quetschverschraubung 	<ul style="list-style-type: none"> ■ with flange, for compression joint

A	B	C	D	E
15,-	38,-	55,-	62,-	74,-
F	G	H	I	L
69,-	75,-	94,-	112,-	169,-

Variante | Alternative



649.15.550 Kupferrohr, 500 mm	Copper tube, 500 mm
<ul style="list-style-type: none"> ■ mit Bördel, für Quetschverschraubung 	<ul style="list-style-type: none"> ■ with flange, for compression joint

A	B	C	D	E
20,-	58,-	77,-	87,-	102,-
F	G	H	I	L
97,-	77,-	96,-	134,-	219,-



649.15.380 Waschtisch-Tassensiphon 1 ¼"	Washbasin cupped siphon trap 1 ¼"
<ul style="list-style-type: none"> ■ massive, eckige Ausführung ■ Rosette ■ Abgangsrohr ø 32 mm 	<ul style="list-style-type: none"> ■ heavy brass, square design ■ escutcheon ■ outlet tube ø 32 mm

A	B	C	D	E
289,-	349,-	423,-	440,-	569,-
F	G	H	I	L
492,-	497,-	642,-	739,-	925,-



649.10.071 Rohrverlängerung, Höhe 150 mm	Body extension, height 150 mm
<ul style="list-style-type: none"> ■ für alle 1-Hand Batterien 	<ul style="list-style-type: none"> ■ for all single lever mixer

A	B	C	D	E
298,-	342,-	392,-	440,-	516,-
F	G	H	I	L
489,-	487,-	620,-	572,-	1.096,-



649.15.290 Zwangsablaufventil	Restraint drain/waste
<ul style="list-style-type: none"> ■ Schaftlänge 70 mm ■ für Waschbecken ohne Überlauf 	<ul style="list-style-type: none"> ■ length of shaft 70 mm ■ for washbasins without overflow

A	B	C	D	E
93,-	116,-	172,-	192,-	255,-
F	G	H	I	L
224,-	247,-	414,-	464,-	612,-

Maßzeichnungen unter www.joerger.de - Menü SERVICE.
 Technical specifications under www.joerger.de - menu SERVICE.

A chrom chrome	[.000]	E platin matt platinum matt	[.066]
B silbernickel polished nickel	[.035]	F nerz matt mink matt	[.096]
C nerz mink	[.095]	G schwarz-matt black matt	[.092]
C nickel matt satin nickel	[.036]	G weiß-matt white matt	[.052]
D edelmessing sunshine	[.040]	H bronze bronze	[.011]
D platin platinum	[.065]	I gold gold	[.020]
E edelmess.matt sunshine matt	[.041]	L roségold rosegold	[.022]
E gold matt gold matt	[.021]	L roségold matt rosegold matt	[.023]

Badewanne, Stand-Batterien | Bath tub mixer sets, deck mount

	621.50.100 5-Loch Wannenfüll- u. Brausebatterie ½", für Standmontage <ul style="list-style-type: none"> ■ Ausladung 153 mm ■ 2 Seitenrandventile mit keramischen Oberteilen ½" ■ 2-Wege Umstellung ■ Metall-Brauseschlauch 2000 mm ■ Metall-Handbrause mit Anti-Kalk-System und Rückflussverhinderer 	Tub/shower mixer set ½", deck mount <ul style="list-style-type: none"> ■ spout projection 153 mm ■ 2 side valves, ceramic internal upper parts ½" ■ 2-position diverter ■ metal shower hose 2000 mm ■ metal hand shower with anticalc. system and backflow preventer 	A	B	C	D	E
			2.174,-	2.904,-	3.469,-	3.904,-	4.597,-
			F	G	H	I	L
			4.256,-	3.385,-	4.214,-	5.621,-	8.191,-

	621.40.150 4-Loch Wannenrandkombination ½" <ul style="list-style-type: none"> ■ für Ab- und Überlaufgarnitur mit Wanneneinlauf, ohne Rohrunterbrecher ■ Seitenrandventile, 2-Wege Umstellung ■ Metall-Brauseschlauch 2000 mm ■ Metall-Handbrause mit Anti-Kalk-System und Rückflussverhinderer 	tub/shower combination ½" <ul style="list-style-type: none"> ■ for waste and overflow set with bath tub filler spout, without pipe interrupter ■ side valves, 2-position diverter ■ metal shower hose 2000 mm ■ metal hand shower with anticalc. system and backflow preventer 	A	B	C	D	E
			1.360,-	2.089,-	2.141,-	2.410,-	2.827,-
			F	G	H	I	L
			2.759,-	2.089,-	2.731,-	3.454,-	4.435,-

	621.10.820 Wannen 1-Hand Batterie <ul style="list-style-type: none"> ■ für freistehende Montage ■ Ausladung 215 mm ■ Umstellung Wanne/Brause ■ Metall-Handbrause mit Anti-Kalk-System und Rückflussverhinderer ■ Metall-Brauseschlauch 1500 mm ■ Standrohr mit Befestigungsflansch ■ Luftsprudler ■ Kartusche mit keramischen Scheiben ■ Höhe gesamt 855 - 935 mm ■ Höhe bis Luftsprudler 705 - 785 mm 	Tub/shower mixer set <ul style="list-style-type: none"> ■ free standing assembly ■ spout projection 215 mm ■ diverter spout/hand shower ■ metal hand shower with anticalc. system and backflow preventer ■ metal shower hose 1500 mm ■ Pillar tube with flange ■ aerator ■ ceramic internal upper part ■ height 855 - 935 mm ■ aerator height 705 - 785 mm 	A	B	C	D	E
			2.599,-	2.998,-	3.364,-	3.782,-	4.655,-
			F	G	H	I	L
			4.176,-	3.274,-	4.516,-	5.340,-	5.962,-

Benötigt | Required

	649.10.970 Bausatz-Vormontage <ul style="list-style-type: none"> ■ Bodenplatte mit Befestigungsset ■ zu Fertigmontageset 621.10.820 	Assembly set for pre-installation <ul style="list-style-type: none"> ■ joint plate with fixing set ■ for assembly set 621.10.820 	A				
			549,-				

	621.50.101 Schwallauslauf, für Wannenrandmontage <ul style="list-style-type: none"> ■ Ausladung 153 mm ■ Strahlregler ■ Anschluss ½" 	Waterfall spout, deck mount <ul style="list-style-type: none"> ■ spout projection 153 mm ■ flow regulator ■ connection ½" 	A	B	C	D	E
			1.176,-	1.248,-	2.104,-	2.369,-	2.790,-
			F	G	H	I	L
			2.569,-	2.054,-	2.521,-	3.624,-	4.289,-

ACUBO

Maßzeichnungen unter www.joerger.de - Menü SERVICE.
 Technical specifications under www.joerger.de - menu SERVICE.

A chrom chrome	[.000]	E platin matt platinum matt	[.066]
B silbernickel polished nickel	[.035]	F nerz matt mink matt	[.096]
C nerz mink	[.095]	G schwarz-matt black matt	[.092]
C nickel matt satin nickel	[.036]	G weiß-matt white matt	[.052]
D edelmessing sunshine	[.040]	H bronze bronze	[.011]
D platin platinum	[.065]	I gold gold	[.020]
E edelmess.matt sunshine matt	[.041]	L roségold rosegold	[.022]
E gold matt gold matt	[.021]	L roségold matt rosegold matt	[.023]

Badewanne, Aufputz-Batterien | Bath tub mixer sets, exposed

	621.20.500 1-Hand Aufputz-Wannenfüll- und Brausebatterie ½", mit Garnitur <ul style="list-style-type: none"> ■ Ausladung 170 mm ■ Metall-Handbrause mit Anti-Kalk-System und Rückflussverhinderer ■ Metall-Brauseschlauch 1500 mm, beidseitig mit drehbarem Konus 	Single lever exposed tub/shower mixer ½", incl. shower set	A	B	C	D	E
			1.332,-	1.812,-	1.926,-	2.031,-	2.504,-
			F	G	H	I	L
			2.288,-	1.898,-	2.194,-	2.802,-	3.589,-

	621.20.510 1-Hand Aufputz-Wannenfüll- und Brausebatterie ½", ohne Garnitur	Single lever exposed tub/shower mixer ½", without shower set	A	B	C	D	E
			989,-	1.332,-	1.432,-	1.612,-	1.900,-
			F	G	H	I	L
			1.810,-	1.463,-	1.741,-	2.222,-	2.845,-

	621.11.100 Wand-Schwalleinlauf ½" <ul style="list-style-type: none"> ■ Ausladung 151 mm ■ Steckanschluß-Montage ■ Strahlregler 	Tub waterfall spout ½"	A	B	C	D	E
			788,-	1.129,-	1.410,-	1.587,-	1.868,-
			F	G	H	I	L
			1.714,-	1.376,-	1.689,-	2.429,-	3.015,-

Dusche, Aufputz-Batterien | Shower mixer sets, exposed

	621.20.600 1-Hand Brausebatterie ½" für Aufputzmontage <ul style="list-style-type: none"> ■ Kartusche mit ker. Scheiben ■ Brauseabgang ½" ■ verdeckte S-Anschlüsse ½" x ¾" 	Single lever exposed shower mixer ½"	A	B	C	D	E
			779,-	1.124,-	1.252,-	1.325,-	1.712,-
			F	G	H	I	L
			1.545,-	1.205,-	1.317,-	1.889,-	2.472,-

Unterputz-Hebelmischer ½" | Concealed single lever mixer ½"

	621.20.125 1-Hand Wannenfüll- und Brausebatterie ½" für UP-Montage, Fertigmontageset <ul style="list-style-type: none"> ■ manuelle, keramische Umstellung für druckunabhängige Funktion ■ mit Sicherheitseinrichtung ■ Durchflußrate 21 l/min bei 3 bar 	Concealed single lever wall tub and shower mixer ½", assembly set	A	B	C	D	E
			838,-	1.094,-	1.273,-	1.313,-	1.610,-
			F	G	H	I	L
			1.424,-	1.149,-	1.538,-	1.776,-	1.956,-

Variante | Alternative

	621.20.235 1-Hand Brausebatterie ½" für UP-Montage, Fertigmontageset <ul style="list-style-type: none"> ■ ohne Umstellung ■ Funktionseinheit mit ker. Scheiben ■ Durchflußrate 20,4 l/min bei 3 bar 	Concealed single lever shower mixer ½", assembly set	A	B	C	D	E
			656,-	809,-	1.046,-	1.077,-	1.348,-
			F	G	H	I	L
			1.179,-	859,-	1.289,-	1.502,-	1.592,-





Benötigt | Required

	649.40.360 Unterputz-Einbaubox ½" <ul style="list-style-type: none"> ■ zu Fertigmontageset 621.20.125 und 621.20.235 ■ für Nass- und Trockenbau geeignet 	Concealed wall box ½"	A				
			168,-				



Maßzeichnungen unter www.joerger.de - Menü SERVICE.
 Technical specifications under www.joerger.de - menu SERVICE.

A chrom chrome	[.000]	E platin matt platinum matt	[.066]
B silbernickel polished nickel	[.035]	F nerz matt milk matt	[.096]
C nerz milk	[.095]	G schwarz-matt black matt	[.092]
C nickel matt satin nickel	[.036]	G weiß-matt white matt	[.052]
D edelmessing sunshine	[.040]	H bronze bronze	[.011]
D platin platinum	[.065]	I gold gold	[.020]
E edelmess.matt sunshine matt	[.041]	L roségold rosegold	[.022]
E gold matt gold matt	[.021]	L roségold matt rosegold matt	[.023]



Unterputz-Thermostate 1/2" | Wall thermostats, concealed 1/2"

	626.40.380	Unterputz-Thermostat 1/2" <u>mit</u> Mengenregulierung, Fertigmontageset <ul style="list-style-type: none"> manuelle, keramische Umstellung Wanne/Brause, druckunabhängig mit Sicherheitseinrichtung Durchflussrate 20,4 l/min bei 3 bar 	Concealed wall thermostat 1/2" <u>with</u> flow control, assembly set <ul style="list-style-type: none"> manual, ceramic diverter tub/shower for pressure-independent function with safety device flow rate 20,4 l/min at 3 bar 	A	B	C	D	E	
				1.179,-	1.342,-	1.436,-	1.545,-	1.829,-	
				F	G	H	I	L	
			1.718,-	1.466,-	1.638,-	1.949,-	2.508,-		
Variante Alternative									
	626.40.360	Unterputz-Thermostat 1/2" <u>mit</u> Mengenregulierung, Fertigmontageset <ul style="list-style-type: none"> ohne Umstellung mit integrierter keramischer Mengenregulierung Durchflussrate 20,4 l/min bei 3 bar 	Concealed wall thermostat 1/2" <u>with</u> flow control, assembly set <ul style="list-style-type: none"> without diverter with integrated ceramic cartridge for volume control flow rate 20,4 l/min at 3 bar 	A	B	C	D	E	
				1.145,-	1.308,-	1.399,-	1.510,-	1.794,-	
				F	G	H	I	L	
			1.664,-	1.432,-	1.599,-	1.915,-	2.474,-		
Variante Alternative									
	626.40.460	Unterputz-Thermostat 1/2" <u>ohne</u> Mengenregulierung, Fertigmontageset <ul style="list-style-type: none"> Funktionseinheit ohne Umstellung und ohne Absperrung Durchflussrate 25,8 l/min bei 3 bar 	Concealed wall thermostat 1/2" <u>without</u> flow control, assembly set <ul style="list-style-type: none"> Functional unit <u>without</u> diverter and <u>without</u> shut-off flow rate 25,8 l/min at 3 bar 	A	B	C	D	E	
				929,-	1.078,-	1.184,-	1.316,-	1.577,-	
				F	G	H	I	L	
			1.469,-	1.280,-	1.428,-	1.691,-	2.244,-		
Benötigt Required									
	649.40.360	Unterputz-Einbaubox 1/2" <ul style="list-style-type: none"> zu Fertigmontageset 626.40.360, 626.40.380 und 626.40.460 für Nass- und Trockenbau geeignet 	Concealed wall box 1/2" <ul style="list-style-type: none"> for assembly set 626.40.360, 626.40.380 and 626.40.460 for wetwall and drywall construction 	A					
				168,-					

Unterputz-Thermostat 3/4" mit hohem Durchfluß | Wall thermostat, concealed 3/4" with high flow











	626.40.555	Unterputz-Thermostat 3/4" <u>ohne</u> Mengenregulierung, Fertigmontageset <ul style="list-style-type: none"> serienbezogener Temperiergriff Sicherheitssperre bei 38° C 	Concealed wall thermostat 3/4" <u>without</u> flow control, assembly set <ul style="list-style-type: none"> design handle for temp. control locking device at 38°C 	A	B	C	D	E	
				577,-	648,-	736,-	779,-	942,-	
				F	G	H	I	L	
			846,-	782,-	949,-	1.262,-	1.676,-		
Benötigt Required									
	649.40.555	Unterputz-Einbaukörper 3/4" <ul style="list-style-type: none"> zu Fertigmontageset 626.40.555 Kartusche mit Schmutzfangsieben für Nass- und Trockenbau geeignet Durchflussrate 64,2 l/min bei 3 bar ohne Absperrung 	Concealed thermostat body 3/4" <ul style="list-style-type: none"> for assembly set 626.40.555 cartridge with filter screens for wetwall and drywall construction flow rate 64,2 l/min at 3 bar without shut-off 	A					
				1.636,-					

Unterputz-Thermostat 3/4" | Wall thermostat, concealed 3/4"

	626.40.520	Unterputz-Thermostat 3/4" <u>ohne</u> Mengenregulierung, Fertigmontageset <ul style="list-style-type: none"> serienbezogener Temperiergriff Sicherheitssperre bei 38° C 	Concealed wall thermostat 3/4" <u>without</u> flow control, assembly set <ul style="list-style-type: none"> design handle for temp. control locking device at 38°C 	A	B	C	D	E	
				577,-	648,-	736,-	779,-	942,-	
				F	G	H	I	L	
			846,-	782,-	949,-	1.262,-	1.676,-		
Benötigt Required									
	649.40.520	Unterputz-Einbaukörper 3/4" <ul style="list-style-type: none"> zu Fertigmontageset 626.40.520 Kartusche mit Schmutzfangsieben für Nass- und Trockenbau geeignet Durchflussrate 41 l/min bei 3 bar ohne Absperrung 	Concealed thermostat body 3/4" <ul style="list-style-type: none"> for assembly set 626.40.520 cartridge with filter screens for wetwall and drywall construction flow rate 41 l/min at 3 bar without shut-off 	A					
				498,-					

A chrom chrome	[.000]	E platin matt platinum matt	[.066]
B silbernickel polished nickel	[.035]	F nerz matt milk matt	[.096]
C nerz milk	[.095]	G schwarz-matt black matt	[.092]
C nickel matt satin nickel	[.036]	G weiß-matt white matt	[.052]
D edelmessing sunshine	[.040]	H bronze bronze	[.011]
D platin platinum	[.065]	I gold gold	[.020]
E edelmess.matt sunshine matt	[.041]	L roségold rosegold	[.022]
E gold matt gold matt	[.021]	L roségold matt rosegold matt	[.023]

Unterputz-Thermostat/Ventil-Modul | Concealed thermostatic/wall-valve modul

		A	B	C	D	E
	621.60.432 Unterputz-Ventil-Modul Fertigmontageset	288,-	375,-	418,-	470,-	553,-
	<ul style="list-style-type: none"> Griff Rosette 					
	Concealed wall-valve-modul assembly set					
		F	G	H	I	L
		511,-	438,-	454,-	659,-	754,-
Benötigt Required						
	649.20.610 Unterputz-Ventil-Modul, 1-fach	229,-				
	<ul style="list-style-type: none"> 1x Spindelventil 3/4", rechtsschließend mit keram. Scheiben 2 Abgänge 1/2", je 1x rechts/links möglich, gleichzeitig benutzbar 					
	Concealed wall-valve-modul, single					
		A				
		699,-				
	649.20.620 Unterputz-Ventil-Modul, 2-fach	458,-				
	<ul style="list-style-type: none"> 2x Spindelventil 3/4", rechtsschließend mit keram. Scheiben 4 Abgänge 1/2", je 2x rechts/links möglich, gleichzeitig benutzbar im Verbund maßgenaue Montage erweiterbar mit 649.20.610 					
	Concealed wall-valve-modul, double					
		A				
		699,-				
	649.20.630 Unterputz-Ventil-Modul, 3-fach	686,-				
	<ul style="list-style-type: none"> 3x Spindelventil 3/4", rechtsschließend mit keram. Scheiben 6 Abgänge 1/2", je 3x rechts/links möglich, gleichzeitig benutzbar im Verbund maßgenauen Montage erweiterbar mit 649.20.610 					
	Concealed wall-valve-modul, triple					
		A				
		699,-				
	626.40.460 Unterputz-Thermostat 1/2" ohne Mengenregulierung, Fertigmontageset	929,-	1.078,-	1.184,-	1.316,-	1.577,-
	<ul style="list-style-type: none"> Funktionseinheit <u>ohne</u> Umstellung und <u>ohne</u> Absperrung Durchflussrate 25,8 l/min bei 3 bar 					
	Concealed wall thermostat 1/2" <u>without</u> flow control, assembly set					
		F	G	H	I	L
		1.469,-	1.280,-	1.428,-	1.691,-	2.244,-
Benötigt Required						
	649.20.612 Anschlußadapter 1/2"	122,-				
	<ul style="list-style-type: none"> Anschlußadapter, Abschlußstopfen passend zu Einbaubox 649.40.360 					
	Connection adapter 1/2"					
		A				
		122,-				
	649.40.360 Unterputz-Einbaubox 1/2"	168,-				
	<ul style="list-style-type: none"> zu Fertigmontageset 626.40.460 für Nass- und Trockenbau geeignet 					
	Concealed wall box 1/2"					
		A				
		168,-				
	626.40.555 Unterputz-Thermostat 3/4" ohne Mengenregulierung, Fertigmontageset	577,-	648,-	736,-	779,-	942,-
	<ul style="list-style-type: none"> serienbezogener Temperiergriff Sicherheitssperre bei 38° C 					
	Concealed wall thermostat 3/4" <u>without</u> flow control, assembly set					
		F	G	H	I	L
		846,-	782,-	949,-	1.262,-	1.676,-
Benötigt Required						
	649.20.634 Anschlußadapter 3/4"	146,-				
	<ul style="list-style-type: none"> Anschlußadapter, Abschlußstopfen passend zu Einbaukörper 649.40.555 					
	Connection adapter 3/4"					
		A				
		146,-				
	649.40.555 Unterputz-Einbaukörper 3/4"	1.636,-				
	<ul style="list-style-type: none"> zu Fertigmontageset 626.40.555 Kartusche mit Schmutzfangsieben für Nass- und Trockenbau geeignet Durchflussrate 64,2 l/min bei 3 bar <u>ohne</u> Absperrung 					
	Concealed thermostat body 3/4"					
		A				
		1.636,-				

Maßzeichnungen unter www.joerger.de - Menü SERVICE.
 Technical specifications under www.joerger.de - menu SERVICE.

A chrom chrome	[.000]	E platin matt platinum matt	[.066]
B silbernickel polished nickel	[.035]	F nerz matt mink matt	[.096]
C nerz mink	[.095]	G schwarz-matt black matt	[.092]
C nickel matt satin nickel	[.036]	G weiß-matt white matt	[.052]
D edelmessing sunshine	[.040]	H bronze bronze	[.011]
D platin platinum	[.065]	I gold gold	[.020]
E edelmess.matt sunshine matt	[.041]	L roségold rosegold	[.022]
E gold matt gold matt	[.021]	L roségold matt rosegold matt	[.023]

Unterputz-Umstellung und Ventile | Diverter and valves concealed



621.40.650 Unterputz 3-Wege Umstellung ½" Fertigmontageset
 ■ Griff
 ■ Hülse, Schubrosette

Concealed 3-position diverter ½" assembly set
 ■ design handle
 ■ socket with adjustable escutcheon

A	B	C	D	E
332,-	431,-	481,-	541,-	636,-
F	G	H	I	L
588,-	408,-	432,-	758,-	867,-

Benötigt | Required



649.40.600 Unterputz 3-Wege Umstellung ½" Einbaukörper
 ■ zu Fertigmontageset 621.40.650

Concealed 3-position diverter ½" diverter body
 ■ for assembly set 621.40.650

A	B	C	D	E
236,-				



621.50.234 Unterputz-Ventil Fertigmontageset
 ■ Griff
 ■ Hülse, Schubrosette

Concealed wall valve assembly set
 ■ design handle
 ■ socket with adjustable escutcheon

A	B	C	D	E
316,-	412,-	460,-	516,-	608,-
F	G	H	I	L
562,-	408,-	432,-	725,-	829,-

Benötigt | Required



649.20.351 Unterputz-Ventil ½", Einbaukörper
 ■ rechtsschließend, ker. Scheiben

Concealed wall valve ½", body
 ■ clockwise closure, ceramic discs

A	B	C	D	E
74,-				



649.20.356 Unterputz-Ventil ½", Einbaukörper
 ■ linksschließend, ker. Scheiben

Concealed wall valve ½", body
 ■ counter-clockwise closure, cer. discs

649.20.451 Unterputz-Ventil ¾", Einbaukörper
 ■ rechtsschließend, ker. Scheiben

Concealed wall valve ¾", body
 ■ clockwise closure, ceramic discs

A	B	C	D	E
102,-				

649.20.456 Unterputz-Ventil ¾", Einbaukörper
 ■ linksschließend, ker. Scheiben

Concealed wall valve ¾", body
 ■ counter-clockwise closure, cer. discs

Brausen | Showers



626.13.300 Duschgarnitur, komplett
 ■ Wandrohr 760 mm, mit Schieber
 ■ Metall-Handbrause mit Anti-Kalk-System und Rückflussverhinderer
 ■ Metall-Brauseschlauch 1750 mm, beidseitig mit drehbarem Konus

Shower bar set, complete
 ■ wall bar 760 mm, with slider
 ■ metal hand shower with anticalc. system and backflow preventer
 ■ metal shower hose 1750 mm, both sides with turning cone

A	B	C	D	E
494,-	692,-	885,-	989,-	1.296,-
F	G	H	I	L
1.149,-	1.098,-	1.689,-	1.742,-	3.014,-

626.13.350 Duschstange, lose
 ■ Wandrohr 760 mm, mit Schieber

Shower bar, separate
 ■ wall bar 760 mm, with slider

A	B	C	D	E
326,-	485,-	576,-	679,-	869,-
F	G	H	I	L
796,-	628,-	929,-	1.138,-	1.866,-



626.13.210 Schlauchbrausegarnitur
 ■ Wandanschlußbogen ½", Schubrosette
 ■ Wand-Brausehalter
 ■ Metall-Handbrause mit Anti-Kalk-System und Rückflussverhinderer
 ■ Metall-Brauseschlauch 1500 mm, beidseitig mit drehbarem Konus

Shower combination
 ■ wall elbow connection ½", escutcheon
 ■ wall fitting for hand shower
 ■ metal hand shower with anticalc. system and backflow preventer
 ■ metal shower hose 1500 mm, both sides with turning cone

A	B	C	D	E
348,-	495,-	583,-	688,-	994,-
F	G	H	I	L
828,-	756,-	1.096,-	1.262,-	1.919,-

ACUBO

Maßzeichnungen unter www.joerger.de - Menü SERVICE.
 Technical specifications under www.joerger.de - menu SERVICE.

A chrom chrome	[.000]	E platin matt platinum matt	[.066]
B silbernickel polished nickel	[.035]	F nerz matt mink matt	[.096]
C nerz mink	[.095]	G schwarz-matt black matt	[.092]
C nickel matt satin nickel	[.036]	G weiß-matt white matt	[.052]
D edelmessing sunshine	[.040]	H bronze bronze	[.011]
D platin platinum	[.065]	I gold gold	[.020]
E edelmess.matt sunshine matt	[.041]	L roségold rosegold	[.022]
E gold matt gold matt	[.021]	L roségold matt rosegold matt	[.023]



626.13.155 Wandanschlußbogen ½“, ohne Haken
 ■ Brauseabgang ½“
 ■ mit Rückflussverhinderer, Rosette

Wall elbow connection ½“, without cradle
 ■ discharge ½“
 ■ with backflow preventer, escutcheon

A	B	C	D	E
145,-	162,-	184,-	209,-	249,-
F	G	H	I	L
227,-	218,-	238,-	296,-	385,-



649.13.220 Wand-Brausehalter

Wall fitting for hand shower

A	B	C	D	E
179,-	206,-	238,-	262,-	314,-
F	G	H	I	L
292,-	212,-	278,-	390,-	479,-



626.13.237 Hygienebrausegarnitur
 ■ Wandbrausehalter und -anschlußbogen ½“, Schubrosette
 ■ Hygienebrause, quadratisch (649.13.334), komplett aus Metall
 ■ einstrahlig, Bedienung über Druckhebel
 ■ Metall-Brauseschlauch 1250 mm

Ablution spray combination
 ■ wall fitting and elbow connection ½“
 ■ spray handshower, square (649.13.334), completely metal
 ■ one jet, push-lever operation
 ■ flexible metal shower hose 1250 mm

A	B	C	D	E
409,-	548,-	696,-	748,-	867,-
F	G	H	I	L
798,-	795,-	1.118,-	1.212,-	1.649,-



621.20.237 1-Hand Batterie ½“ für Hygiene-Brause, Fertigmontageset
 ■ Rosette, Griff

Concealed single lever ½“ for ablu-tion spray, assembly set
 ■ escutcheon, handle

A	B	C	D	E
271,-	319,-	449,-	505,-	594,-
F	G	H	I	L
559,-	532,-	612,-	690,-	810,-

Benötigt | Required



649.20.237 Unterputz 1-Hand Batterie ½“, Einbaukörper
 ■ Kartusche mit keramischen Scheiben
 ■ zu Fertigmontageset 621.20.237

Single lever mixer ½“, concealed body
 ■ cartridge with ceramic discs
 ■ for assembly set 621.20.237

A	B	C	D	E
125,-	169,-	208,-	229,-	268,-
F	G	H	I	L
249,-	224,-	258,-	329,-	396,-



649.13.975 Regenbrause ½“, 300 x 300 mm
 ■ Ausführung ganz in Metall
 ■ 3 mm ultra flach
 ■ mit Kugelgelenk
 ■ Anti-Kalk-System
 ■ ohne Wandarm

Rain shower head ½“, 300 x 300 mm
 ■ full metal body
 ■ 3 mm ultra-thin
 ■ with ball joint
 ■ with anticalcareous system
 ■ without wall bracket

A	B	C	D	E
756,-	1.646,-	1.854,-	1.989,-	2.398,-
F	G	H	I	L
2.296,-	1.854,-	2.368,-	2.896,-	3.568,-

■ weitere, zur Serie passende Kopfbrausen siehe Kapitel “Brausen”

■ for further shower heads matching this collection see chapter “showers”

Empfohlen | Recommended



649.13.785 Wandarm ½“
 ■ Ausladung 350 mm
 ■ weitere, zur Serie passende Wandarme siehe Kapitel “Brausen”

Wall bracket ½“
 ■ projection 350 mm
 ■ for further wall brackets matching this collection see chapter “showers”

A	B	C	D	E
198,-	264,-	318,-	346,-	456,-
F	G	H	I	L
399,-	334,-	436,-	518,-	740,-

ACUBO

Maßzeichnungen unter www.joerger.de - Menü SERVICE.
 Technical specifications under www.joerger.de - menu SERVICE.

A chrom chrome	[.000]	E platin matt platinum matt	[.066]
B silbernickel polished nickel	[.035]	F nerz matt mink matt	[.096]
C nerz mink	[.095]	G schwarz-matt black matt	[.092]
C nickel matt satin nickel	[.036]	G weiß-matt white matt	[.052]
D edelmessing sunshine	[.040]	H bronze bronze	[.011]
D platin platinum	[.065]	I gold gold	[.020]
E edelmess.matt sunshine matt	[.041]	L roségold rosegold	[.022]
E gold matt gold matt	[.021]	L roségold matt rosegold matt	[.023]



649.13.771 Deckenanbindung ½“
 ■ Länge 150 mm
 ■ weitere, zur Serie passende Deckenanbindungen siehe Kapitel "Brausen"

Ceiling bracket ½“
 ■ length 150 mm
 ■ for further ceiling brackets matching this collection see chapter "showers"

A	B	C	D	E
176,-	292,-	350,-	395,-	462,-
F	G	H	I	L
446,-	350,-	442,-	558,-	836,-



649.13.526 Seitenbrause ½“
 ■ Rosette 125 x 125 mm, Wandmontage
 ■ Brausekopf schwenkbar, 20°
 ■ Anti-Kalk-System
 ■ Material: Kunststoff
 ■ weitere, zur Serie passende Seitenbrausen siehe Kapitel "Brausen"

Body spray side shower ½“
 ■ escutcheon 125 x 125 mm, wall assembly
 ■ swivel shower head, 20°
 ■ anticalcareous system
 ■ plastic
 ■ for further side showers matching this collection see chapter "showers"

A	B	C	D	E
186,-	329,-	384,-	406,-	542,-
F	G	H	I	L
508,-	392,-	472,-	659,-	944,-



649.13.375 Handbrause ½“
 ■ Ausführung Metall
 ■ Anti-Kalk-System
 ■ Anschluß ½“

Hand shower ½“
 ■ brass
 ■ anticalcareous system
 ■ connection ½“

A	B	C	D	E
168,-	212,-	288,-	324,-	379,-
F	G	H	I	L
352,-	314,-	392,-	439,-	629,-

A chrom chrome	[.000]	E platin matt platinum matt	[.066]
B silbernickel polished nickel	[.035]	F nerz matt mink matt	[.096]
C nerz mink	[.095]	G schwarz-matt black matt	[.092]
C nickel matt satin nickel	[.036]	G weiß-matt white matt	[.052]
D edelmessing sunshine	[.040]	H bronze bronze	[.011]
D platin platinum	[.065]	I gold gold	[.020]
E edelmess.matt sunshine matt	[.041]	L roségold rosegold	[.022]
E gold matt gold matt	[.021]	L roségold matt rosegold matt	[.023]

Accessoires für Handtücher | Accessories for towels

	626.00.002 Handtuchhalter ■ Rohr starr, ca. 410 mm	Towel bar ■ rigid bar, approx. 410 mm	A	B	C	D	E
			125,-	182,-	236,-	266,-	312,-
			F	G	H	I	L
			289,-	236,-	290,-	376,-	678,-

	627.00.047 Handtuchring ■ 220 x 105 mm ■ geschlossene Ausführung	Towel ring ■ 220 x 105 mm ■ closed version	A	B	C	D	E
			138,-	199,-	259,-	292,-	342,-
			F	G	H	I	L
			318,-	285,-	319,-	414,-	746,-

	626.00.022 Handtuchhaken	Robe hanger	A	B	C	D	E
			59,-	84,-	89,-	96,-	116,-
			F	G	H	I	L
			108,-	98,-	112,-	156,-	268,-

	626.00.040 Badetuchhalter ■ ca. 770 mm	Bath towel bar ■ approx. 770 mm	A	B	C	D	E
			189,-	324,-	459,-	519,-	772,-
			F	G	H	I	L
			666,-	335,-	616,-	986,-	1.432,-

	626.00.031 Wannengriff ■ ca. 305 mm	Tub handle ■ approx. 305 mm	A	B	C	D	E
			124,-	192,-	264,-	298,-	436,-
			F	G	H	I	L
			378,-	278,-	416,-	556,-	872,-

	626.00.030 Duschtürgriff ■ ca. 600 mm	Shower door handle ■ approx. 600 mm	A	B	C	D	E
			316,-	475,-	599,-	669,-	929,-
			F	G	H	I	L
			819,-	639,-	889,-	1.199,-	1.929,-

	634.00.104 Gästehandtuchkorb, eckig ■ mit Ablage ■ Korbgröße 260 x 150 x 190 mm	Guest towel basket, angular ■ with shelf ■ basket size 260 x 150 x 190 mm	A	B	C	D	E
			230,-	314,-	356,-	389,-	528,-
			F	G	H	I	L
			466,-	492,-	675,-	849,-	1.499,-

ACUBO

Maßzeichnungen unter www.joerger.de - Menü SERVICE.
 Technical specifications under www.joerger.de - menu SERVICE.

A chrom chrome	[.000]	E platin matt platinum matt	[.066]
B silbernickel polished nickel	[.035]	F nerz matt milk matt	[.096]
C nerz milk	[.095]	G schwarz-matt black matt	[.092]
C nickel matt satin nickel	[.036]	G weiß-matt white matt	[.052]
D edelmessing sunshine	[.040]	H bronze bronze	[.011]
D platin platinum	[.065]	I gold gold	[.020]
E edelmess.matt sunshine matt	[.041]	L roségold rosegold	[.022]
E gold matt gold matt	[.021]	L roségold matt rosegold matt	[.023]

	627.00.036 Glashalter, komplett ■ Glas aus Kristallglas, seidenmatt ■ Ausrichtung nach links ■ Auf Wunsch ist die Ausrichtung auch nach rechts möglich	Tumbler holder, complete ■ crystal glass tumbler, frosted ■ left side alignment ■ on request, the alignment is also possible to the right	A	B	C	D	E
			116,-	192,-	228,-	245,-	326,-
			F	G	H	I	L
			288,-	179,-	240,-	359,-	482,-

	727.00.336 Mundglas, seidenmatt, lose	Glass tumbler, frosted, separate	A				
			54,-				

	627.00.046 Glashalter, komplett ■ Standmodell ■ Glas aus Kristallglas, seidenmatt	Tumbler holder, complete ■ free standing version ■ crystal glass tumbler, frosted	A	B	C	D	E
			96,-	115,-	127,-	142,-	182,-
			F	G	H	I	L
			162,-	174,-	236,-	284,-	364,-

Accessoires für WC-Bühler | Accessories for w.c. bowl

	626.00.014 Papierhalter ■ beweglicher Bügel	Toilet paper roll holder ■ mobile bracket	A	B	C	D	E
			179,-	214,-	264,-	289,-	398,-
			F	G	H	I	L
			352,-	319,-	519,-	756,-	986,-

	626.00.015 Reserve-Papierhalter	Spare toilet paper roll holder	A	B	C	D	E
			116,-	159,-	205,-	225,-	310,-
			F	G	H	I	L
			275,-	188,-	299,-	349,-	544,-

	627.00.000 Klosettbürstengarnitur, komplett ■ wandhängendes Modell ■ Bürstentopf aus Metall	Toilet brush holder set, complete ■ suspended model ■ brush holder out of brass	A	B	C	D	E
			238,-	327,-	399,-	435,-	592,-
			F	G	H	I	L
			526,-	509,-	749,-	964,-	1.352,-

	677.00.053 Bürstenstange, komplett, lose	Brush rod with brush, separate	A	B	C	D	E
			84,-	114,-	139,-	152,-	208,-
			F	G	H	I	L
			184,-	178,-	262,-	332,-	472,-

	799.00.236 Bürstenkopf, lose	Brush, separate	A				
			22,-				

Maßzeichnungen unter www.joerger.de - Menü SERVICE.
 Technical specifications under www.joerger.de - menu SERVICE.

A chrom chrome	[.000]	E platin matt platinum matt	[.066]
B silbernickel polished nickel	[.035]	F nerz matt mink matt	[.096]
C nerz mink	[.095]	G schwarz-matt black matt	[.092]
C nickel matt satin nickel	[.036]	G weiß-matt white matt	[.052]
D edelmessing sunshine	[.040]	H bronze bronze	[.011]
D platin platinum	[.065]	I gold gold	[.020]
E edelmess.matt sunshine matt	[.041]	L roségold rosegold	[.022]
E gold matt gold matt	[.021]	L roségold matt rosegold matt	[.023]



627.00.001 Klosettbürstengarnitur, komplett
 ■ stehendes Modell
 ■ Bürstentopf aus Metall

Toilet brush holder set, complete
 ■ floor standing model
 ■ brush holder out of brass

A	B	C	D	E
198,-	286,-	359,-	395,-	552,-
F	G	H	I	L
486,-	469,-	709,-	924,-	1.312,-

Spiegel | Mirrors



649.00.418 Kosmetikspiegel, beleuchtet
 ■ schwenk- und ausziehbar
 ■ 3-fache Vergrößerung
 ■ Direktanschluss
 ■ Spiegeldurchmesser 185 mm
 ■ Rahmendurchmesser 250 mm
 ■ Kalt-, Warm- und Taglicht durch Piezzo-Schalter umschaltbar

Cosmetic mirror, incl. lighting
 ■ swivelling and extendable
 ■ magnification 3:1
 ■ direct connection
 ■ mirror diameter 185 mm
 ■ frame diameter 250 mm
 ■ cold, warm and day light switchable by Piezzo switch

A	B	C	D	E
556,-	988,-	1.214,-	1.418,-	1.828,-
F	G	H	I	L
1.684,-	1.214,-	1.549,-	2.138,-	2.998,-



Oberflächen | colours

Folgende Oberflächen sind bei dieser Serie möglich |
The following colours are possible with this collection

chrom	chrome	[.000]	PG A
silbernickel	polished nickel	[.035]	PG B
nerz	mink	[.095]	PG C
nickel matt	satin nickel	[.036]	PG C
edelmessing	sunshine	[.040]	PG D
platin	platinum	[.065]	PG D
edelmessing matt	sunshine matt	[.041]	PG E
gold matt	gold matt	[.021]	PG E
platin matt	platinum matt	[.066]	PG E
nerz matt	mink matt	[.096]	PG F
schwarz matt/chrom	black matt/chrome	[.920]	PG G
weiß matt/chrom	white matt/chrome	[.520]	PG G
bronze	bronze	[.011]	PG H
gold	gold	[.020]	PG I
roségold	rosegold	[.022]	PG L
roségold matt	rosegold matt	[.023]	PG L
himmelblau/chrom	azure/chrome	[.790]	PG H
apfelgrün/chrom	applegreen/chrome	[.630]	PG H
lila/chrom	purple/chrome	[.840]	PG H
rosa/chrom	pink/chrome	[.810]	PG H
türkis/chrom	turquoise/chrome	[.760]	PG H
orange/chrom	orange/chrome	[.930]	PG H
gelb/chrom	yellow/chrome	[.910]	PG H
rot/chrom	red/chrome	[.820]	PG H

Andere Oberflächen auf Anfrage |
Different colours on request

Waschtisch | Washbasin

ab Seite | from page 283

Bidet | Bidet

ab Seite | from page 283

Wanne | Bath tub

ab Seite | from page 284

Dusche | Shower

ab Seite | from page 285

Accessoires | Accessories

ab Seite | from page 290

Auf Anfrage können wir Produkte von
Drittanbietern auch gerne passend zu unseren
Oberflächen veredeln (vorbehaltlich der
Eignungsprüfung) | Third-party products may be
plated matching to our colours on request
(subject to valuation of suitability)

PLATEAU

Standardmäßig werden die Armaturen ohne Dekor geliefert. Sollte ein nachfolgendes Laserdekor gewünscht sein, bitten wir darum, dies bei der Bestellung über die Artikelnummer und Beschreibung gesondert aufzuführen, wie es das Beispiel rechts zeigt.

Bei welchen Artikel ein Laserdekor möglich ist, wird durch das nachfolgende Zeichen gekennzeichnet: 



Zusätzlich zur Artikelnummer der Armatur wird das Laserdekor über eine separate Artikelnummer bestellt. Beispiel:

Modell	Oberfläche	Beschreibung	Preis
1x 630.10.333.000		Waschtisch 1-Hand Batterie	879,-
1x 630_ARTN		Laserdekor ART N	120,-
Gesamtpreis:			999,-

Eigene, individuelle Dekore sind auf Wunsch gegen einen Kostenbeitrag in Höhe von 339,- EURO ebenfalls möglich.

By default, the taps are delivered without laser pattern. A designated pattern may be ordered separately by mentioning the item number and description, as shown in the example on the right.

Articles with the following mark are possible for a laser pattern: 

In addition to the article number of the tap the laser pattern is ordered by a separate article number. As an example:

model	colour	description	price
1x 630.10.333.000		Single lever washbasin mixer	879,-
1x 630_ARTN		Laser pattern ART N	120,-
total price:			999,-

Individual designs are also possible for a price of 339,- EURO.

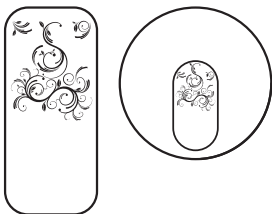
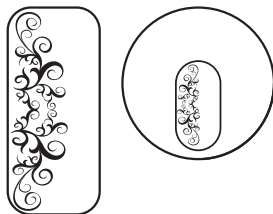
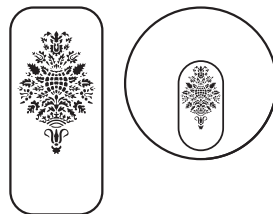
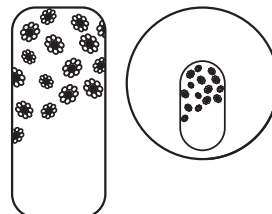
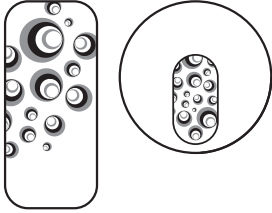
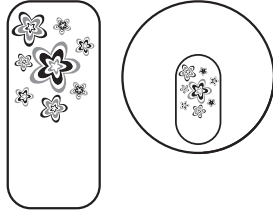
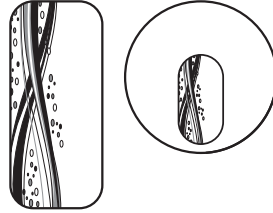
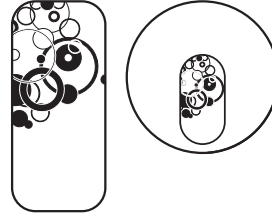
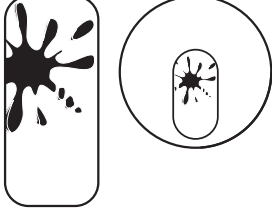
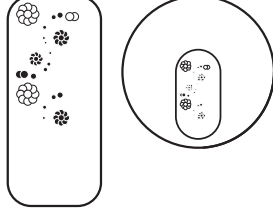
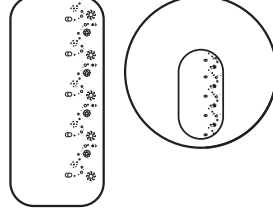
				Preis price
<p>630_RETRO</p>  <p>Motiv RETRO pattern RETRO</p>	<p>630_ARTN</p>  <p>Motiv ART N pattern ART N</p>	<p>630_CLASSIC</p>  <p>Motiv CLASSIC pattern CLASSIC</p>	<p>630_FLOWERS</p>  <p>Motiv FLOWERS pattern FLOWERS</p>	249,-
<p>630_POPART</p>  <p>Motiv POP ART pattern POP ART</p>	<p>630_POWERF</p>  <p>Motiv POWER FLOWER pattern POWER FLOWER</p>	<p>630_BAMBOO</p>  <p>Motiv BAMBUS pattern BAMBOO</p>	<p>630_SEVENTIES</p>  <p>Motiv SEVENTIES pattern SEVENTIES</p>	249,-
<p>630_SPLASH</p>  <p>Motiv SPLASH pattern SPLASH</p>	<p>630_CIRCLES</p>  <p>Motiv CIRCLES pattern CIRCLES</p>	<p>630_CIRCLES MINI</p>  <p>Motiv CIRCLES MINI pattern CIRCLES MINI</p>		249,-

PLATEAU

Maßzeichnungen unter www.joerger.de - Menü SERVICE.
 Technical specifications under www.joerger.de - menu SERVICE.

A chrom chrome	[.000]	E platin matt platinum matt	[.066]
B silbernickel polished nickel	[.035]	F nerz matt mink matt	[.096]
C nerz mink	[.095]	G schwarz matt black matt	[.920]
C nickel matt satin nickel	[.036]	H farbig coloured	[.xxx]
D edelmessing sunshine	[.040]	H bronze bronze	[.011]
D platin platinum	[.065]	I gold gold	[.020]
E edelmess.matt sunshine matt	[.041]	L roségold rosegold	[.022]
E gold matt gold matt	[.021]	L roségold matt rosegold matt	[.023]

Waschtisch Batterien | Washbasin mixer

	630.30.300 Waschtisch 3-Loch Batterie ½" <ul style="list-style-type: none"> Ausladung 125 mm; Höhe 108 mm 2 Seitenrandventile mit keramischen Oberteilen ½" Ablaufventil mit Klickverschluß 1 ¼" empfohlen: 2x 649.15.530 - Kupferrohr 300 mm 	Washbasin 3-hole mixer ½" <ul style="list-style-type: none"> spout projection 125 mm; height 108 mm 2 side valves with ceramic internal upper parts ½" push-open waste 1 ¼" recommended: 2x 649.15.530 - copper tube 300 mm 	A	B	C	D	E	
				989,-	1.536,-	1.745,-	1.859,-	2.438,-
				F	G	H	I	L
			2.188,-	1.619,-	1.914,-	2.699,-	3.357,-	

	630.10.333 Waschtisch 1-Hand Batterie <ul style="list-style-type: none"> Ausladung 125 mm; Höhe 120 mm Kartusche mit ker. Scheiben Ablaufventil mit Klickverschluß 1 ¼" 2 Druckschläuche M10x1 x 450 mm 	Single lever washbasin mixer <ul style="list-style-type: none"> spout projection 125 mm; height 120 mm cartridge with ceramic discs push-open waste 1 ¼" 2 pressure hoses M10x1 x 450 mm 	A	B	C	D	E
			879,-	1.068,-	1.140,-	1.192,-	1.494,-
			F	G	H	I	L
		1.361,-	1.258,-	1.469,-	1.632,-	2.657,-	

Variante | Alternative

	630.10.334 Waschtisch 1-Hand Batterie <ul style="list-style-type: none"> <u>ohne</u> Ablaufventil 	Single lever washbasin mixer <ul style="list-style-type: none"> <u>without</u> waste 	A	B	C	D	E
			828,-	968,-	1.023,-	1.154,-	1.360,-
			F	G	H	I	L
		1.186,-	999,-	1.324,-	1.580,-	2.452,-	

	630.10.332 Waschtisch 1-Hand Batterie <ul style="list-style-type: none"> Ausladung 125 mm; Höhe 250 mm Kartusche mit ker. Scheiben <u>ohne</u> Ablaufventil 2 Druckschläuche M10x1 x 450 mm 	Single lever washbasin mixer <ul style="list-style-type: none"> spout projection 125 mm; height 250 mm cartridge with ceramic discs <u>without</u> waste 2 pressure hoses M10x1 x 450 mm 	A	B	C	D	E
			1.109,-	1.312,-	1.542,-	1.732,-	2.043,-
			F	G	H	I	L
		1.927,-	1.760,-	1.770,-	2.374,-	2.616,-	

Bidet Batterien | Bidet mixer

	630.10.111 Bidet 1-Hand Batterie <ul style="list-style-type: none"> Ausladung 167 mm; Höhe 105 mm Kartusche mit keramischen Scheiben Ablaufventil mit Klickverschluß 1 ¼" 2 Druckschläuche M10x1 x 450 mm 	Single lever bidet mixer <ul style="list-style-type: none"> spout projection 167 mm; height 105 mm cartridge with ceramic discs push-open waste 1 ¼" 2 pressure hoses M10x1 x 450 mm 	A	B	C	D	E
			974,-	1.172,-	1.248,-	1.309,-	1.625,-
			F	G	H	I	L
		1.484,-	1.329,-	1.534,-	1.774,-	2.722,-	

Zubehör für Waschtisch- und Bidet-Batterien | Supplies for washbasin and bidet mixer





	649.15.340 Waschtisch-Tassensiphon 1 ¼" <ul style="list-style-type: none"> schwere Ausführung Rosette Abgangsrohr ø 32 mm Tauchrohlänge 165 mm 	Washbasin cupped siphon trap 1 ¼" <ul style="list-style-type: none"> heavy brass escutcheon outlet tube ø 32 mm dip pipe 165 mm 	A	B	C	D	E
			195,-	296,-	368,-	429,-	568,-
			F	G	H	I	L
		498,-	378,-	539,-	686,-	832,-	

	630.12.100 Eckventil ½" <ul style="list-style-type: none"> Ausladung 100 mm Fettkammer-Innenoberteil ½" Quetschverschraubung Schubrosette 	Angle valve ½" <ul style="list-style-type: none"> projection 100 mm cartridge ½" compression joint escutcheon 	A	B	C	D	E
			116,-	167,-	231,-	261,-	343,-
			F	G	H	I	L
		315,-	190,-	370,-	371,-	614,-	





PLATEAU

Maßzeichnungen unter www.joerger.de - Menü SERVICE.
 Technical specifications under www.joerger.de - menu SERVICE.

A chrom chrome	[.000]	E platin matt platinum matt	[.066]
B silbernickel polished nickel	[.035]	F nerz matt milk matt	[.096]
C nerz milk	[.095]	G schwarz-matt black matt	[.920]
C nickel matt satin nickel	[.036]	H farbig coloured	[.xxx]
D edelmessing sunshine	[.040]	H bronze bronze	[.011]
D platin platinum	[.065]	I gold gold	[.020]
E edelmess.matt sunshine matt	[.041]	L roségold rosegold	[.022]
E gold matt gold matt	[.021]	L roségold matt rosegold matt	[.023]

	649.15.530 Kupferrohr, 300 mm ■ mit Bördel, für Quetschverschraubung	Copper tube, 300 mm ■ with flange, for compression joint	A	B	C	D	E
			15,-	38,-	55,-	62,-	74,-
Variante Alternative			F	G	H	I	L
			69,-	75,-	94,-	112,-	169,-
	649.15.550 Kupferrohr, 500 mm ■ mit Bördel, für Quetschverschraubung	Copper tube, 500 mm ■ with flange, for compression joint	A	B	C	D	E
			20,-	58,-	77,-	87,-	102,-
			F	G	H	I	L
			97,-	77,-	96,-	134,-	219,-
	649.15.270 Zwangsablaufventil ■ Schaftlänge 70 mm ■ für Waschbecken ohne Überlauf	Restraint drain/waste ■ lenght of shaft 70 mm ■ for washbasins without overflow	A	B	C	D	E
			68,-	129,-	185,-	239,-	312,-
			F	G	H	I	L
			299,-	176,-	394,-	429,-	582,-
	649.15.271 Zwangsablaufventil ■ Schaftlänge 100 mm ■ für Waschbecken ohne Überlauf	Restraint drain/waste ■ lenght of shaft 100 mm ■ for washbasins without overflow	A	B	C	D	E
			72,-	138,-	196,-	254,-	329,-
			F	G	H	I	L
			318,-	186,-	418,-	454,-	616,-

Badewanne, Stand-Batterien | Bath tub mixer sets, deck mount

	630.40.100 4-Loch Wannenfüll- u. Brausebatterie ½", für Standmontage ■ Ausladung 220 mm; Höhe 108 mm ■ 2 Seitenrandventile mit keramischen Oberteilen ½" ■ Metall-Brauseschlauch 2000 mm ■ Metall-Handbrause mit Anti-Kalk-System und Rückflussverhinderer	Tub/shower mixer set ½" deck mount ■ projection 220 mm; height 108 mm ■ 2 side valves, ceramic internal upper parts ½" ■ metal shower hose 2000 mm ■ metal hand shower with anticalc. system and backflow preventer	A	B	C	D	E
			1.572,-	2.088,-	2.431,-	2.736,-	3.386,-
			F	G	H	I	L
			3.032,-	1.981,-	2.967,-	4.065,-	4.585,-
	649.40.160 Montageplatte, komplett ■ für 4-Loch Armaturen ■ Druckschläuche ½" x ½" x 600 mm ■ Schlauchkastensystem siehe Kapitel "Serienübergreifendes"	Assembly plate, complete ■ for deck mounted tub/shower mixer ■ pressure hoses ½" x ½" x 600 mm ■ system with hose box see chapter "universal products"	A				
			308,-				
	630.40.150 4-Loch Wannenrandkombination ½" ■ für Ab- und Überlaufgarnitur mit Wanneneinlauf, ohne Rohrunterbrecher ■ Seitenrandventile, 2-Wege Umstellung ■ Metall-Brauseschlauch 2000 mm ■ Metall-Handbrause mit Anti-Kalk-System und Rückflussverhinderer	tub/shower combination ½" ■ for waste and overflow set with bath tub filler spout, without pipe interrupter ■ side valves, 2-position diverter ■ metal shower hose 2000 mm ■ metal hand shower with anticalc. system and backflow preventer	A	B	C	D	E
			1.397,-	1.609,-	2.158,-	2.429,-	2.851,-
			F	G	H	I	L
			2.662,-	1.832,-	2.762,-	3.501,-	3.909,-
	649.40.160 Montageplatte, komplett ■ für 4-Loch Armaturen ■ Druckschläuche ½" x ½" x 600 mm ■ empfohlen: Schlauchkastensystem siehe Kapitel "Serienübergreifendes"	Assembly plate, complete ■ for deck mounted tub/shower mixer ■ pressure hoses ½" x ½" x 600 mm ■ recommended: system with hose box see chapter "universal products"	A				
			308,-				

PLATEAU

Maßzeichnungen unter www.joerger.de - Menü SERVICE.
 Technical specifications under www.joerger.de - menu SERVICE.

A chrom chrome	[.000]	E platin matt platinum matt	[.066]
B silbernickel polished nickel	[.035]	F nerz matt milk matt	[.096]
C nerz milk	[.095]	G schwarz-matt black matt	[.920]
C nickel matt satin nickel	[.036]	H farbig coloured	[.xxx]
D edelmessing sunshine	[.040]	H bronze bronze	[.011]
D platin platinum	[.065]	I gold gold	[.020]
E edelmess.matt sunshine matt	[.041]	L roségold rosegold	[.022]
E gold matt gold matt	[.021]	L roségold matt rosegold matt	[.023]

Badewanne und Dusche, Aufputz-Batterien | Bath tub and shower mixer sets, exposed

	630.20.500 1-Hand Aufputz-Wannenfüll- und Brausebatterie 1/2", mit Garnitur <ul style="list-style-type: none"> ■ Ausladung 170 mm ■ Metall-Handbrause mit Anti-Kalk-System und Rückflussverhinderer ■ Metall-Brauseschlauch 1500 mm 	Single lever exposed tub/shower mixer 1/2", incl. shower set <ul style="list-style-type: none"> ■ spout projection 170 mm ■ metal hand shower with anticalc. system and backflow preventer ■ metal shower hose 1500 mm 	A	B	C	D	E
			987,-	1.442,-	1.650,-	1.773,-	2.322,-
			F	G	H	I	L
			2.081,-	1.551,-	1.915,-	2.578,-	3.270,-

Variante | Alternative

	630.20.510 1-Hand Aufputz-Wannenfüll- und Brausebatterie 1/2", ohne Garnitur <ul style="list-style-type: none"> ■ Höhe 775 - 800 mm 	Single lever exposed tub/shower mixer 1/2", without shower set	A	B	C	D	E
			821,-	1.109,-	1.308,-	1.472,-	1.734,-
			F	G	H	I	L
			1.516,-	1.232,-	1.590,-	2.030,-	2.633,-

Optional | Optional

	615.15.260 Wasserzufuhrstandrohre 1/2" <ul style="list-style-type: none"> ■ 2 Stück, in Boden einzuschrauben ■ inkl. Winkelstück zum Anschluß der AP-WFB Batterie 630.20.500 ■ Höhe 775 - 800 mm 	Water supply pipes 1/2" <ul style="list-style-type: none"> ■ 2 pieces, floor installation ■ incl. angle for connecting tub/shower mixer 630.20.500 ■ height 775 - 800 mm 	A	B	C	D	E
			872,-	908,-	1.644,-	1.851,-	2.179,-
			F	G	H	I	L
			2.043,-	1.321,-	1.958,-	2.445,-	3.349,-

Empfohlen | Recommended

	109.10.970 Bausatz-Vormontage <ul style="list-style-type: none"> ■ Bodenplatte mit Befestigungsset ■ für Wasserzufuhrstandrohre 615.15.260 	Assembly set for pre-installation <ul style="list-style-type: none"> ■ joint plate with fixing set ■ for water supply pipes 615.15.260 	A				
			459,-				

	630.20.600 1-Hand Brausebatterie 1/2" für Aufputzmontage <ul style="list-style-type: none"> ■ Kartusche mit ker. Scheiben ■ Brauseabgang 1/2" ■ verdeckte S-Anschlüsse 1/2" x 3/4" 	Single lever exposed shower mixer 1/2" <ul style="list-style-type: none"> ■ cartridge with ceramic discs ■ discharge 1/2" ■ concealed S-connections 1/2" x 3/4" 	A	B	C	D	E
			680,-	959,-	1.086,-	1.222,-	1.464,-
			F	G	H	I	L
			1.320,-	1.110,-	1.358,-	1.686,-	2.385,-

Unterputz-Hebelmischer 1/2" | Concealed single lever mixer 1/2"

	630.20.125 1-Hand Wannenfüll- und Brausebatterie 1/2" für UP-Montage, Fertigmontageset <ul style="list-style-type: none"> ■ manuelle, keramische Umstellung für druckunabhängige Funktion ■ mit Sicherheitseinrichtung ■ Durchflussrate 21 l/min bei 3 bar 	Concealed single lever wall tub and shower mixer 1/2", assembly set <ul style="list-style-type: none"> ■ manual, ceramic diverter tub/shower for pressure-independent function ■ with safety device ■ flow rate 21 l/min at 3 bar 	A	B	C	D	E
			850,-	1.078,-	1.287,-	1.328,-	1.625,-
			F	G	H	I	L
			1.414,-	1.091,-	1.553,-	1.792,-	1.899,-

Benötigt | Required

	649.40.360 Unterputz-Einbaubox 1/2" <ul style="list-style-type: none"> ■ zu Fertigmontageset 630.20.125 und 630.20.235 ■ für Nass- und Trockenbau geeignet 	Concealed wall box 1/2" <ul style="list-style-type: none"> ■ for assembly set 630.20.125 and 630.20.235 ■ for wetwall and drywall construction 	A				
			168,-				

Maßzeichnungen unter www.joerger.de - Menü SERVICE.
 Technical specifications under www.joerger.de - menu SERVICE.

A chrom chrome	[.000]	E platin matt platinum matt	[.066]
B silbernickel polished nickel	[.035]	F nerz matt mink matt	[.096]
C nerz mink	[.095]	G schwarz-matt black matt	[.920]
C nickel matt satin nickel	[.036]	H farbig coloured	[.xxx]
D edelmessing sunshine	[.040]	H bronze bronze	[.011]
D platin platinum	[.065]	I gold gold	[.020]
E edelmess.matt sunshine matt	[.041]	L roségold rosegold	[.022]
E gold matt gold matt	[.021]	L roségold matt rosegold matt	[.023]

Variante | Alternative

	630.20.235 1-Hand Brausebatterie ½" für UP-Montage, Fertigmontageset	Concealed single lever shower mixer ½", assembly set	A	B	C	D	E	
	<ul style="list-style-type: none"> ohne Umstellung Funktionseinheit mit ker. Scheiben Durchflußrate 20,4 l/min bei 3 bar 	<ul style="list-style-type: none"> without diverter functional unit with ceramic discs flow rate 20,4 l/min at 3 bar 	671,-	766,-	1.061,-	1.091,-	1.364,-	
			F	G	H	I	L	
				1.236,-	783,-	1.303,-	1.517,-	1.724,-

Benötigt | Required

	649.40.360 Unterputz-Einbaubox ½"	Concealed wall box ½"	A				
	<ul style="list-style-type: none"> zu Fertigmontageset 630.20.125 und 630.20.235 für Nass- und Trockenbau geeignet 	<ul style="list-style-type: none"> for assembly set 630.20.125 and 630.20.235 for wetwall and drywall construction 	168,-				

Unterputz-Thermostate ½" | Wall thermostats, concealed ½"

	615.40.380 Unterputz-Thermostat ½" mit Mengenregulierung, Fertigmontageset	Concealed wall thermostat ½" with flow control, assembly set	A	B	C	D	E	
	<ul style="list-style-type: none"> manuelle, keramische Umstellung Wanne/Brause, druckunabhängig mit Sicherheitseinrichtung Durchflußrate 20,4 l/min bei 3 bar 	<ul style="list-style-type: none"> manual, ceramic diverter tub/shower for pressure-independent function with safety device flow rate 20,4 l/min at 3 bar 	1.094,-	1.224,-	1.437,-	1.483,-	1.767,-	
			F	G	H	I	L	
				1.626,-	1.437,-	1.704,-	1.887,-	2.349,-

Variante | Alternative

	615.40.360 Unterputz-Thermostat ½" mit Mengenregulierung, Fertigmontageset	Concealed wall thermostat ½" with flow control, assembly set	A	B	C	D	E	
	<ul style="list-style-type: none"> ohne Umstellung mit integrierter keramischer Mengenregulierung Durchflußrate 20,4 l/min bei 3 bar 	<ul style="list-style-type: none"> without diverter with integrated ceramic cartridge for volume control flow rate 20,4 l/min at 3 bar 	1.079,-	1.209,-	1.399,-	1.448,-	1.732,-	
			F	G	H	I	L	
				1.592,-	1.399,-	1.669,-	1.853,-	2.334,-

Variante | Alternative

	615.40.460 Unterputz-Thermostat ½" ohne Mengenregulierung, Fertigmontageset	Concealed wall thermostat ½" without flow control, assembly set	A	B	C	D	E	
	<ul style="list-style-type: none"> Funktionseinheit ohne Umstellung und ohne Absperrung Durchflußrate 25,8 l/min bei 3 bar 	<ul style="list-style-type: none"> Functional unit without diverter and without shut-off flow rate 25,8 l/min at 3 bar 	898,-	1.028,-	1.192,-	1.226,-	1.486,-	
			F	G	H	I	L	
				1.368,-	1.192,-	1.434,-	1.679,-	2.153,-

Benötigt | Required

	649.40.360 Unterputz-Einbaubox ½"	Concealed wall box ½"	A				
	<ul style="list-style-type: none"> zu Fertigmontageset 615.40.360, 615.40.380 und 615.40.460 für Nass- und Trockenbau geeignet 	<ul style="list-style-type: none"> for assembly set 615.40.360, 615.40.380 and 615.40.460 for wetwall and drywall construction 	168,-				

Unterputz-Thermostat ¾" mit hohem Durchfluß | Wall thermostat, concealed ¾" with high flow

	630.40.555 Unterputz-Thermostat ¾" ohne Mengenregulierung, Fertigmontageset	Concealed wall thermostat ¾" without flow control, assembly set	A	B	C	D	E	
	<ul style="list-style-type: none"> serienbezogener Temperiergriff Sicherheitssperre bei 38° C 	<ul style="list-style-type: none"> design handle for temp. control locking device at 38° C 	503,-	618,-	881,-	916,-	1.187,-	
			F	G	H	I	L	
				1.120,-	703,-	1.252,-	1.391,-	1.650,-

Benötigt | Required











	649.40.555 Unterputz-Einbaukörper ¾"	Concealed thermostat body ¾"	A				
	<ul style="list-style-type: none"> zu Fertigmontageset 630.40.555 Kartusche mit Schmutzfangsieben für Nass- und Trockenbau geeignet Durchflußrate 64,2 l/min bei 3 bar ohne Absperrung 	<ul style="list-style-type: none"> for assembly set 630.40.555 cartridge with filter screens for wetwall and drywall construction flow rate 64,2 l/min at 3 bar without shut-off 	1.636,-				

PLATEAU

Maßzeichnungen unter www.joerger.de - Menü SERVICE.
 Technical specifications under www.joerger.de - menu SERVICE.

A chrom chrome	[.000]	E platin matt platinum matt	[.066]
B silbernickel polished nickel	[.035]	F nerz matt milk matt	[.096]
C nerz milk	[.095]	G schwarz-matt black matt	[.920]
C nickel matt satin nickel	[.036]	H farbig coloured	[.xxx]
D edelmessing sunshine	[.040]	H bronze bronze	[.011]
D platin platinum	[.065]	I gold gold	[.020]
E edelmess.matt sunshine matt	[.041]	L roségold rosegold	[.022]
E gold matt gold matt	[.021]	L roségold matt rosegold matt	[.023]

Unterputz-Thermostat/Ventil-Modul | Concealed thermostatic/wall-valve modul

			A	B	C	D	E
	630.60.432 Unterputz-Ventil-Modul Fertigmontageset	Concealed wall-valve-modul assembly set	275,-	318,-	398,-	447,-	528,-
	<ul style="list-style-type: none"> Griff Rosette 	<ul style="list-style-type: none"> design handle escutcheon 					
	Benötigt Required						
	649.20.610 Unterputz-Ventil-Modul, 1-fach	Concealed wall-valve-modul, single	229,-				
	<ul style="list-style-type: none"> 1x Spindelventil 3/4", rechtsschließend mit keram. Scheiben 2 Abgänge 1/2", je 1x rechts/links möglich, gleichzeitig benutzbar 	<ul style="list-style-type: none"> 1x spindle valve 3/4", clockwise closure with ceramic discs 2 outlets 1/2", each 1x right/left possible, simultaneously usable 					
	Benötigt Required						
	649.20.620 Unterputz-Ventil-Modul, 2-fach	Concealed wall-valve-modul, double	458,-				
	<ul style="list-style-type: none"> 2x Spindelventil 3/4", rechtsschließend mit keram. Scheiben 4 Abgänge 1/2", je 2x rechts/links möglich, gleichzeitig benutzbar im Verbund maßgenaue Montage erweiterbar mit 649.20.610 	<ul style="list-style-type: none"> 2x spindle valve 3/4", clockwise closure with ceramic discs 4 outlets 1/2", each 2x right/left possible, simultaneously usable precise assembly due to composite expandable with 649.20.610 					
	Benötigt Required						
	649.20.630 Unterputz-Ventil-Modul, 3-fach	Concealed wall-valve-modul, triple	686,-				
	<ul style="list-style-type: none"> 3x Spindelventil 3/4", rechtsschließend mit keram. Scheiben 6 Abgänge 1/2", je 3x rechts/links möglich, gleichzeitig benutzbar im Verbund maßgenauen Montage erweiterbar mit 649.20.610 	<ul style="list-style-type: none"> 3x spindle valve 3/4", clockwise closure with ceramic discs 6 outlets 1/2", each 3x right/left possible, simultaneously usable precise assembly due to composite expandable with 649.20.610 					
	Benötigt Required						
	615.40.460 Unterputz-Thermostat 1/2" <u>ohne</u> Mengenregulierung, Fertigmontageset	Concealed wall thermostat 1/2" <u>without</u> flow control, assembly set	898,-	1.028,-	1.192,-	1.226,-	1.486,-
	<ul style="list-style-type: none"> Funktionseinheit <u>ohne</u> Umstellung und <u>ohne</u> Absperrung Durchflussrate 25,8 l/min bei 3 bar 	<ul style="list-style-type: none"> Functional unit <u>without</u> diverter and <u>without</u> shut-off flow rate 25,8 l/min at 3 bar 					
	Benötigt Required						
	649.20.612 Anschlußadapter 1/2"	Connection adapter 1/2"	122,-				
	<ul style="list-style-type: none"> Anschlußadapter, Abschlußstopfen passend zu Einbaubox 649.40.360 	<ul style="list-style-type: none"> connection adapter, end plug matching to wall box 649.40.360 					
	Benötigt Required						
	649.40.360 Unterputz-Einbaubox 1/2"	Concealed wall box 1/2"	168,-				
	<ul style="list-style-type: none"> zu Fertigmontageset 615.40.460 für Nass- und Trockenbau geeignet 	<ul style="list-style-type: none"> for assembly set 615.40.460 for wetwall and drywall construction 					
	Benötigt Required						
	630.40.555 Unterputz-Thermostat 3/4" <u>ohne</u> Mengenregulierung, Fertigmontageset	Concealed wall thermostat 3/4" <u>without</u> flow control, assembly set	503,-	618,-	881,-	916,-	1.187,-
	<ul style="list-style-type: none"> serienbezogener Temperiergriff Sicherheitssperre bei 38° C 	<ul style="list-style-type: none"> design handle for temp. control locking device at 38° C 					
	Benötigt Required						
	649.20.634 Anschlußadapter 3/4"	Connection adapter 3/4"	146,-				
	<ul style="list-style-type: none"> Anschlußadapter, Abschlußstopfen passend zu Einbaukörper 649.40.555 	<ul style="list-style-type: none"> connection adapter, end plug matching to wall body 649.40.555 					
	Benötigt Required						
	649.40.555 Unterputz-Einbaukörper 3/4"	Concealed thermostat body 3/4"	1.636,-				
	<ul style="list-style-type: none"> zu Fertigmontageset 630.40.555 Kartusche mit Schmutzfangsieben für Nass- und Trockenbau geeignet Durchflussrate 64,2 l/min bei 3 bar <u>ohne</u> Absperrung 	<ul style="list-style-type: none"> for assembly set 630.40.555 cartridge with filter screens for wetwall and drywall construction flow rate 64,2 l/min at 3 bar <u>without</u> shut-off 					
	Benötigt Required						

PLATEAU

Maßzeichnungen unter www.joerger.de - Menü SERVICE.
 Technical specifications under www.joerger.de - menu SERVICE.

A chrom chrome	[.000]	E platin matt platinum matt	[.066]
B silbernickel polished nickel	[.035]	F nerz matt mink matt	[.096]
C nerz mink	[.095]	G schwarz-matt black matt	[.920]
C nickel matt satin nickel	[.036]	H farbig coloured	[.xxx]
D edelmessing sunshine	[.040]	H bronze bronze	[.011]
D platin platinum	[.065]	I gold gold	[.020]
E edelmess.matt sunshine matt	[.041]	L roségold rosegold	[.022]
E gold matt gold matt	[.021]	L roségold matt rosegold matt	[.023]

Unterputz-Umstellung und Ventile | Diverter and valves concealed



630.40.650 Unterputz 3-Wege Umstellung ½" Fertigmontageset
 ■ Griff
 ■ Hülse, Schubrosette

Concealed 3-position diverter ½" assembly set
 ■ design handle
 ■ socket with adjustable escutcheon

A	B	C	D	E
392,-	442,-	452,-	466,-	560,-
F	G	H	I	L
518,-	471,-	554,-	628,-	753,-

Benötigt | Required



649.40.600 Unterputz 3-Wege Umstellung ½" Einbaukörper
 ■ zu Fertigmontageset 630.40.650

Concealed 3-position diverter ½" diverter body
 ■ for assembly set 630.40.650

A	B	C	D	E
236,-				



630.50.234 Unterputz-Ventil Fertigmontageset
 ■ Griff
 ■ Hülse, Schubrosette

Concealed wall valve assembly set
 ■ design handle
 ■ socket with adjustable escutcheon

A	B	C	D	E
271,-	369,-	410,-	442,-	559,-
F	G	H	I	L
505,-	390,-	484,-	621,-	678,-

Benötigt | Required



649.20.350 Unterputz-Ventil ½", Einbaukörper
 ■ rechtsschließend, ker. Scheiben

Concealed wall valve ½", body
 ■ clockwise closure, ceramic discs

A	B	C	D	E
66,-				



649.20.355 Unterputz-Ventil ½", Einbaukörper
 ■ linksschließend, ker. Scheiben

Concealed wall valve ½", body
 ■ counter-clockwise closure, cer. discs

649.20.450 Unterputz-Ventil ¾", Einbaukörper
 ■ rechtsschließend, ker. Scheiben

Concealed wall valve ¾", body
 ■ clockwise closure, ceramic discs

A	B	C	D	E
99,-				



649.20.455 Unterputz-Ventil ¾", Einbaukörper
 ■ linksschließend, ker. Scheiben

Concealed wall valve ¾", body
 ■ counter-clockwise closure, cer. discs

Brausen | Showers



630.13.300 Duschgarnitur, komplett
 ■ Wandrohr 780 mm, mit Schieber
 ■ Metall-Handbrause mit Anti-Kalk-System und Rückflussverhinderer
 ■ Metall-Brauseschlauch 1750 mm, beidseitig mit drehbarem Konus

Shower bar set, complete
 ■ wall bar 780 mm, with slider
 ■ metal hand shower with anticalc. system and backflow preventer
 ■ metal shower hose 1750 mm, both sides with turning cone

A	B	C	D	E
535,-	759,-	962,-	1.055,-	1.482,-
F	G	H	I	L
1.300,-	1.133,-	1.634,-	1.674,-	2.958,-

630.13.350 Duschstange, lose
 ■ Wandrohr 780 mm, mit Schieber

Shower bar, separate
 ■ wall bar 780 mm, with slider

A	B	C	D	E
439,-	618,-	728,-	804,-	1.054,-
F	G	H	I	L
938,-	690,-	1.372,-	1.449,-	1.834,-

630.13.200 Schlauchbrausegarnitur
 ■ Wandanschlußbogen ½", Schubrosette
 ■ Wand-Brausehalter
 ■ Metall-Handbrause mit Anti-Kalk-System und Rückflussverhinderer
 ■ Metall-Brauseschlauch 1500 mm, beidseitig mit drehbarem Konus

Shower combination
 ■ wall elbow connection ½", escutcheon
 ■ wall fitting for hand shower
 ■ metal hand shower with anticalc. system and backflow preventer
 ■ metal shower hose 1500 mm, both sides with turning cone

A	B	C	D	E
305,-	428,-	518,-	583,-	768,-
F	G	H	I	L
680,-	709,-	1.032,-	862,-	1.564,-



PLATEAU

Maßzeichnungen unter www.joerger.de - Menü SERVICE.
 Technical specifications under www.joerger.de - menu SERVICE.

A chrom chrome	[.000]	E platin matt platinum matt	[.066]
B silbernickel polished nickel	[.035]	F nerz matt mink matt	[.096]
C nerz mink	[.095]	G schwarz-matt black matt	[.920]
C nickel matt satin nickel	[.036]	H farbig coloured	[.xxx]
D edelmessing sunshine	[.040]	H bronze bronze	[.011]
D platin platinum	[.065]	I gold gold	[.020]
E edelmess.matt sunshine matt	[.041]	L roségold rosegold	[.022]
E gold matt gold matt	[.021]	L roségold matt rosegold matt	[.023]



632.13.150 Wandanschlußbogen ½“, ohne Haken
 ■ Brauseabgang ½“
 ■ mit Rückflussverhinderer, Rosette

Wall elbow connection ½“, without cradle
 ■ discharge ½“
 ■ with backflow preventer, escutcheon

A	B	C	D	E
89,-	98,-	106,-	112,-	178,-
F	G	H	I	L
152,-	148,-	187,-	239,-	306,-



632.13.270 Wand-Brausehalter

Wall fitting for hand shower

A	B	C	D	E
79,-	79,-	89,-	99,-	158,-
F	G	H	I	L
132,-	114,-	154,-	198,-	296,-



619.13.237 Hygienebrausegarnitur
 ■ Wandbrausehalter und -anschlußbogen ½“, Schubrosette
 ■ Hygienebrause, modern (649.13.337), komplett aus Metall
 ■ einstrahlig, Bedienung über Druckhebel
 ■ Metall-Brauseschlauch 1250 mm

Ablution spray combination
 ■ wall fitting and elbow connection ½“
 ■ spray handshower, modern (649.13.337), completely metal
 ■ one jet, push-lever operation
 ■ flexible metal shower hose 1250 mm

A	B	C	D	E
271,-	436,-	489,-	569,-	668,-
F	G	H	I	L
629,-	659,-	994,-	1.169,-	1.532,-



615.20.237 1-Hand Batterie ½“ für Hygiene-Brause, Fertigmontageset
 ■ Rosette, Griff

Concealed single lever ½“ for ablution spray, assembly set
 ■ escutcheon, handle

A	B	C	D	E
271,-	359,-	439,-	496,-	580,-
F	G	H	I	L
549,-	439,-	526,-	658,-	729,-

Benötigt | Required



649.20.237 Unterputz 1-Hand Batterie ½“, Einbaukörper
 ■ Kartusche mit keramischen Scheiben
 ■ zu Fertigmontageset 615.20.237

Single lever mixer ½“, concealed body
 ■ cartridge with ceramic discs
 ■ for assembly set 615.20.237

A	B	C	D	E
125,-	169,-	208,-	229,-	268,-
F	G	H	I	L
249,-	224,-	258,-	329,-	396,-



649.13.845 Regenbrause ½“, ø 300 mm
 ■ Ausführung ganz in Metall
 ■ 3 mm ultra flach
 ■ mit Kugelgelenk
 ■ Anti-Kalk-System
 ■ ohne Wandarm
 ■ weitere, zur Serie passende Kopfbrausen siehe Kapitel “Brausen”

Rain shower head ½“, ø 300 mm
 ■ full metal body
 ■ 3 mm ultra-thin
 ■ with ball joint
 ■ with anticalcareous system
 ■ without wall bracket
 ■ for further shower heads matching this collection see chapter “showers”

A	B	C	D	E
687,-	1.329,-	1.562,-	1.669,-	1.998,-
F	G	H	I	L
1.814,-	1.562,-	1.974,-	2.396,-	2.876,-

Empfohlen | Recommended



649.13.755 Wandarm ½“
 ■ Ausladung 350 mm
 ■ weitere, zur Serie passende Wandarme siehe Kapitel “Brausen”

Wall bracket ½“
 ■ projection 350 mm
 ■ for further wall brackets matching this collection see chapter “showers”

A	B	C	D	E
129,-	288,-	316,-	349,-	439,-
F	G	H	I	L
399,-	288,-	328,-	479,-	539,-

PLATEAU

Maßzeichnungen unter www.joerger.de - Menü SERVICE.
 Technical specifications under www.joerger.de - menu SERVICE.

A chrom chrome	[.000]	E platin matt platinum matt	[.066]
B silbernickel polished nickel	[.035]	F nerz matt mink matt	[.096]
C nerz mink	[.095]	G schwarz-matt black matt	[.920]
C nickel matt satin nickel	[.036]	H farbig coloured	[.xxx]
D edelmessing sunshine	[.040]	H bronze bronze	[.011]
D platin platinum	[.065]	I gold gold	[.020]
E edelmess.matt sunshine matt	[.041]	L roségold rosegold	[.022]
E gold matt gold matt	[.021]	L roségold matt rosegold matt	[.023]



- 649.13.530** Seitenbrause ½“
- Rosette 125 x 125 mm, Wandmontage
 - Brausekopf schwenkbar, 20°
 - Anti-Kalk-System
 - Material: Kunststoff
- weitere, zur Serie passende Seitenbrausen siehe Kapitel "Brausen"

- Body spray side shower ½“**
- escutcheon 125 x 125 mm, wall assembly
 - swivel shower head, 20°
 - anticalcareous system
 - plastic
- for further side showers matching this collection see chapter "showers"

A	B	C	D	E
167,-	224,-	385,-	406,-	555,-
F	G	H	I	L
495,-	314,-	472,-	665,-	854,-

Accessoires für Handtücher | Accessories for towels



- 630.00.002** Handtuchhalter
- Rohre schwenkbar, ca. 410 mm

- Towel bar**
- swivelling bars, approx. 410 mm

A	B	C	D	E
329,-	522,-	636,-	689,-	948,-
F	G	H	I	L
838,-	463,-	542,-	1.064,-	1.366,-



- 630.00.047** Handtuchring
- ø ca. 235 mm
 - offene Ausführung

- Towel ring**
- ø approx. 235 mm
 - open version

A	B	C	D	E
342,-	369,-	485,-	545,-	636,-
F	G	H	I	L
596,-	451,-	591,-	789,-	878,-



- 630.00.022** Handtuchhaken

- Robe hanger**

A	B	C	D	E
53,-	106,-	108,-	112,-	132,-
F	G	H	I	L
122,-	115,-	132,-	149,-	190,-



- 630.00.040** Badetuchhalter
- ca. 600 mm

- Bath towel bar**
- approx. 600 mm

A	B	C	D	E
276,-	494,-	630,-	692,-	975,-
F	G	H	I	L
855,-	452,-	724,-	1.104,-	1.540,-



- 630.00.041** Badetuchhalter, doppelt
- ca. 600 mm

- Bath towel bar, double**
- approx. 600 mm

A	B	C	D	E
326,-	588,-	749,-	824,-	1.162,-
F	G	H	I	L
1.019,-	652,-	999,-	1.314,-	2.152,-



- 630.00.031** Wannengriff
- ca. 270 mm

- Tub handle**
- approx. 270 mm

A	B	C	D	E
232,-	345,-	409,-	442,-	595,-
F	G	H	I	L
529,-	394,-	522,-	665,-	978,-

PLATEAU

Maßzeichnungen unter www.joerger.de - Menü SERVICE.
 Technical specifications under www.joerger.de - menu SERVICE.

A chrom chrome	[.000]	E platin matt platinum matt	[.066]
B silbernickel polished nickel	[.035]	F nerz matt milk matt	[.096]
C nerz milk	[.095]	G schwarz-matt black matt	[.920]
C nickel matt satin nickel	[.036]	H farbig coloured	[.xxx]
D edelmessing sunshine	[.040]	H bronze bronze	[.011]
D platin platinum	[.065]	I gold gold	[.020]
E edelmess.matt sunshine matt	[.041]	L roségold rosegold	[.022]
E gold matt gold matt	[.021]	L roségold matt rosegold matt	[.023]

	630.00.102 Gästehandtuchkorb, eckig ■ 230 x 70 x 100 mm	Guest towel basket, angular ■ 230 x 70 x 100 mm	A	B	C	D	E
			301,-	532,-	662,-	722,-	999,-
			F	G	H	I	L
			882,-	526,-	944,-	1.228,-	1.852,-

Accessoires für Waschplatz | Accessories for washstands

	630.00.107 Schwammkorb ■ rechteckig, 200 x 80 mm	Sponge basket ■ rectangular, 200 x 80 mm	A	B	C	D	E
			256,-	370,-	426,-	455,-	599,-
			F	G	H	I	L
			539,-	485,-	678,-	669,-	1.186,-

	630.00.007 Seifenhalter, komplett ■ Seifenschale aus Kristallglas	Soap dish holder, complete ■ crystal glass dish	A	B	C	D	E
			262,-	272,-	308,-	345,-	406,-
			F	G	H	I	L
			382,-	329,-	378,-	504,-	518,-

	713.00.307 Seifenschale, lose	Glass dish, separate	A				
			74,-				

	630.00.006 Lotionspender, komplett ■ Wandmodell ■ Ausführung Metall	Soap dispenser, complete ■ wall version ■ brass	A	B	C	D	E
			294,-	314,-	363,-	411,-	483,-
			F	G	H	I	L
			437,-	406,-	482,-	599,-	809,-

	630.00.016 Lotionspender, komplett ■ Standmodell ■ Ausführung Metall	Soap dispenser, complete ■ free standing version ■ brass	A	B	C	D	E
			129,-	208,-	226,-	253,-	299,-
			F	G	H	I	L
			256,-	393,-	534,-	370,-	1.009,-

	630.00.008 Seifenhalter ■ Standmodell ■ Ausführung Metall	Soap dish holder ■ free standing version ■ brass	A	B	C	D	E
			105,-	310,-	354,-	378,-	498,-
			F	G	H	I	L
			446,-	432,-	434,-	552,-	754,-

	630.00.036 Glashalter, komplett ■ Glas aus Kristallglas	Tumbler holder, complete ■ crystal glass tumbler	A	B	C	D	E
			258,-	269,-	300,-	337,-	397,-
			F	G	H	I	L
			379,-	335,-	428,-	491,-	632,-

	713.00.336 Mundglas, lose	Glass tumbler, separate	A				
			78,-				

PLATEAU

Maßzeichnungen unter www.joerger.de - Menü SERVICE.
 Technical specifications under www.joerger.de - menu SERVICE.

A chrom chrome	[.000]	E platin matt platinum matt	[.066]
B silbernickel polished nickel	[.035]	F nerz matt mink matt	[.096]
C nerz mink	[.095]	G schwarz-matt black matt	[.920]
C nickel matt satin nickel	[.036]	H farbig coloured	[.xxx]
D edelmessing sunshine	[.040]	H bronze bronze	[.011]
D platin platinum	[.065]	I gold gold	[.020]
E edelmess.matt sunshine matt	[.041]	L roségold rosegold	[.022]
E gold matt gold matt	[.021]	L roségold matt rosegold matt	[.023]

Accessoires für WC-Bereich | Accessories for w.c. area

	630.00.014 Papierhalter ■ mit Deckel	Toilet paper roll holder ■ with lid	A	B	C	D	E
			195,-	278,-	325,-	349,-	468,-
			F	G	H	I	L
			417,-	367,-	545,-	522,-	1.029,-

	630.00.015 Reserve-Papierhalter	Spare toilet paper roll holder	A	B	C	D	E
			214,-	264,-	286,-	305,-	380,-
			F	G	H	I	L
			345,-	270,-	374,-	418,-	617,-

	630.00.000 Klosettbürstengarnitur, komplett ■ wandhängendes Modell ■ Bürstentopf aus Messing	Toilet brush holder set, complete ■ suspended model ■ brush pot out of brass	A	B	C	D	E
			474,-	644,-	734,-	782,-	1.024,-
			F	G	H	I	L
			919,-	702,-	922,-	1.136,-	1.526,-

	680.00.053 Bürstenstange, komplett, lose	Brush rod with brush, separate	A	B	C	D	E
			126,-	129,-	221,-	247,-	292,-
			F	G	H	I	L
			262,-	173,-	272,-	364,-	425,-

799.00.236 Bürstenkopf, lose	Brush, separate	A				
		22,-				

	630.00.001 Klosettbürstengarnitur, komplett ■ stehendes Modell ■ Bürstentopf aus Messing	Toilet brush holder set, complete ■ floor standing model ■ brush pot out of brass	A	B	C	D	E
			187,-	362,-	399,-	524,-	644,-
			F	G	H	I	L
			592,-	556,-	788,-	699,-	1.391,-

Spiegel | Mirror

	649.00.414 Kosmetikspiegel, beleuchtet ■ schwenk- und ausziehbar ■ 3-fache Vergrößerung ■ Direktanschluss ■ Spiegeldurchmesser 185 mm ■ Rahmendurchmesser 250 mm ■ Kalt-, Warm- und Taglicht durch Piezzo-Schalter umschaltbar	Cosmetic mirror, incl. lighting ■ swivelling and extendable ■ magnification 3:1 ■ direct connection ■ mirror diameter 185 mm ■ frame diameter 250 mm ■ cold, warm and day light switchable by Piezzo switch	A	B	C	D	E
			556,-	988,-	1.214,-	1.418,-	1.828,-
			F	G	H	I	L
			1.684,-	1.214,-	1.549,-	2.138,-	2.998,-



Oberflächen | colours

Folgende Oberflächen sind bei dieser Serie möglich |
The following colours are possible with this collection

chrom	chrome	[.000]	PG A
silbernickel	polished nickel	[.035]	PG B
nerz	mink	[.095]	PG C
nickel matt	satin nickel	[.036]	PG C
edelmessing	sunshine	[.040]	PG D
platin	platinum	[.065]	PG D
edelmessing matt	sunshine matt	[.041]	PG E
gold matt	gold matt	[.021]	PG E
platin matt	platinum matt	[.066]	PG E
nerz matt	mink matt	[.096]	PG F
schwarz matt	black matt	[.092]	PG G
weiß matt	white matt	[.052]	PG G
bronze	bronze	[.011]	PG H
gold	gold	[.020]	PG I
roségold	rosegold	[.022]	PG L
roségold matt	rosegold matt	[.023]	PG L

Andere Oberflächen auf Anfrage |
Different colours on request

Auf Anfrage können wir Produkte von Drittanbietern auch gerne passend zu unseren Oberflächen veredeln (vorbehaltlich der Eignungsprüfung) | Third-party products may be plated matching to our colours on request (subject to valuation of suitability)

Waschtisch | Washbasin

ab Seite | from page 294

Bidet | Bidet

ab Seite | from page 294

Wanne | Bath tub

ab Seite | from page 295

Dusche | Shower

ab Seite | from page 296

Accessoires | Accessories

ab Seite | from page 303

SERIE 1909

Maßzeichnungen unter www.joerger.de - Menü SERVICE.
 Technical specifications under www.joerger.de - menu SERVICE.

A chrom chrome	[.000]	E platin matt platinum matt	[.066]
B silbernickel polished nickel	[.035]	F nerz matt mink matt	[.096]
C nerz mink	[.095]	G schwarz-matt black matt	[.092]
C nickel matt satin nickel	[.036]	G weiß-matt white matt	[.052]
D edelmessing sunshine	[.040]	H bronze bronze	[.011]
D platin platinum	[.065]	I gold gold	[.020]
E edelmess.matt sunshine matt	[.041]	L roségold rosegold	[.022]
E gold matt gold matt	[.021]	L roségold matt rosegold matt	[.023]

Waschtisch Batterien | Washbasin mixer

	629.30.300 Waschtisch 3-Loch Batterie 1/2" <ul style="list-style-type: none"> ■ Ausladung 150 mm; Höhe 134 mm ■ 2 Seitenrandventile mit keramischen Oberteilen 1/2" ■ Exzenter-Ablaufgarnitur 1 1/4" ■ empfohlen: 2x 649.15.530 - Kupferrohr 300 mm 	Washbasin 3-hole mixer 1/2" <ul style="list-style-type: none"> ■ spout projection 150 mm; height 134 mm ■ 2 side valves with ceramic internal upper parts 1/2" ■ pop-up waste 1 1/4" ■ recommended: 2x 649.15.530 - copper tube 300 mm 	<table border="1"> <tr><th>A</th><th>B</th><th>C</th><th>D</th><th>E</th></tr> <tr><td>829,-</td><td>1.089,-</td><td>1.257,-</td><td>1.415,-</td><td>1.666,-</td></tr> <tr><th>F</th><th>G</th><th>H</th><th>I</th><th>L</th></tr> <tr><td>1.508,-</td><td>1.381,-</td><td>1.694,-</td><td>2.013,-</td><td>3.137,-</td></tr> </table>	A	B	C	D	E	829,-	1.089,-	1.257,-	1.415,-	1.666,-	F	G	H	I	L	1.508,-	1.381,-	1.694,-	2.013,-	3.137,-
	A	B	C	D	E																		
	829,-	1.089,-	1.257,-	1.415,-	1.666,-																		
F	G	H	I	L																			
1.508,-	1.381,-	1.694,-	2.013,-	3.137,-																			

	629.10.300 Waschtisch 1-Loch Batterie 1/2" <ul style="list-style-type: none"> ■ Ausladung 122 mm; Höhe 115 mm ■ Keramik-Innenoberteile 1/2" ■ Exzenter-Ablaufgarnitur 1 1/4" ■ 2 Kupferrohre M10x1 x 400 mm 	Washbasin 1-hole mixer 1/2" <ul style="list-style-type: none"> ■ spout projection 122 mm; height 115 mm ■ ceramic internal upper parts 1/2" ■ pop-up waste 1 1/4" ■ 2 copper tubes M10x1 x 400 mm 	<table border="1"> <tr><th>A</th><th>B</th><th>C</th><th>D</th><th>E</th></tr> <tr><td>467,-</td><td>637,-</td><td>760,-</td><td>854,-</td><td>1.054,-</td></tr> <tr><th>F</th><th>G</th><th>H</th><th>I</th><th>L</th></tr> <tr><td>932,-</td><td>928,-</td><td>1.119,-</td><td>1.221,-</td><td>2.380,-</td></tr> </table>	A	B	C	D	E	467,-	637,-	760,-	854,-	1.054,-	F	G	H	I	L	932,-	928,-	1.119,-	1.221,-	2.380,-
	A	B	C	D	E																		
	467,-	637,-	760,-	854,-	1.054,-																		
F	G	H	I	L																			
932,-	928,-	1.119,-	1.221,-	2.380,-																			

	629.20.650 Wand-Brückenbatterie 1/2" mit hohem Auslauf <ul style="list-style-type: none"> ■ Ausladung 258 mm; Höhe 200 mm ■ Schwenkauslauf ■ 2 keramische Oberteile 1/2" 	Wall washbasin bridge mixer 1/2" with high spout <ul style="list-style-type: none"> ■ spout projection 258 mm; height 200 mm ■ swivel spout ■ 2 ceramic internal upper parts 1/2" 	<table border="1"> <tr><th>A</th><th>B</th><th>C</th><th>D</th><th>E</th></tr> <tr><td>543,-</td><td>685,-</td><td>884,-</td><td>995,-</td><td>1.218,-</td></tr> <tr><th>F</th><th>G</th><th>H</th><th>I</th><th>L</th></tr> <tr><td>1.084,-</td><td>1.118,-</td><td>1.329,-</td><td>1.420,-</td><td>2.070,-</td></tr> </table>	A	B	C	D	E	543,-	685,-	884,-	995,-	1.218,-	F	G	H	I	L	1.084,-	1.118,-	1.329,-	1.420,-	2.070,-
	A	B	C	D	E																		
	543,-	685,-	884,-	995,-	1.218,-																		
F	G	H	I	L																			
1.084,-	1.118,-	1.329,-	1.420,-	2.070,-																			

Bidet Batterien | Bidet mixer

	629.10.100 Bidet 1-Loch Batterie 1/2" <ul style="list-style-type: none"> ■ Ausladung 110 mm; Höhe 110 mm ■ Keramik-Innenoberteile 1/2" ■ Exzenter-Ablaufgarnitur 1 1/4" ■ 2 Kupferrohre M10x1 x 400 mm 	Bidet 1-hole mixer 1/2" <ul style="list-style-type: none"> ■ spout projection 110 mm; height 110 mm ■ ceramic internal upper parts 1/2" ■ pop-up waste 1 1/4" ■ 2 copper tubes M10x1 x 400 mm 	<table border="1"> <tr><th>A</th><th>B</th><th>C</th><th>D</th><th>E</th></tr> <tr><td>554,-</td><td>678,-</td><td>903,-</td><td>1.015,-</td><td>1.243,-</td></tr> <tr><th>F</th><th>G</th><th>H</th><th>I</th><th>L</th></tr> <tr><td>1.112,-</td><td>876,-</td><td>1.118,-</td><td>1.449,-</td><td>2.306,-</td></tr> </table>	A	B	C	D	E	554,-	678,-	903,-	1.015,-	1.243,-	F	G	H	I	L	1.112,-	876,-	1.118,-	1.449,-	2.306,-
	A	B	C	D	E																		
	554,-	678,-	903,-	1.015,-	1.243,-																		
F	G	H	I	L																			
1.112,-	876,-	1.118,-	1.449,-	2.306,-																			

Zubehör für Waschtisch- und Bidet-Batterien | Supplies for washbasin and bidet mixer

	629.12.100 Eckventil 1/2" <ul style="list-style-type: none"> ■ Ausladung 136 mm ■ Fettkammer-Innenoberteil 1/2" ■ Quetschverschraubung ■ Schubrosette 	Angle valve 1/2" <ul style="list-style-type: none"> ■ projection 136 mm ■ cartridge 1/2" ■ compression joint ■ escutcheon 	<table border="1"> <tr><th>A</th><th>B</th><th>C</th><th>D</th><th>E</th></tr> <tr><td>233,-</td><td>246,-</td><td>350,-</td><td>393,-</td><td>463,-</td></tr> <tr><th>F</th><th>G</th><th>H</th><th>I</th><th>L</th></tr> <tr><td>424,-</td><td>276,-</td><td>459,-</td><td>551,-</td><td>694,-</td></tr> </table>	A	B	C	D	E	233,-	246,-	350,-	393,-	463,-	F	G	H	I	L	424,-	276,-	459,-	551,-	694,-
	A	B	C	D	E																		
	233,-	246,-	350,-	393,-	463,-																		
F	G	H	I	L																			
424,-	276,-	459,-	551,-	694,-																			

	649.15.530 Kupferrohr, 300 mm <ul style="list-style-type: none"> ■ mit Bördel, für Quetschverschraubung 	Copper tube, 300 mm <ul style="list-style-type: none"> ■ with flange, for compression joint 	<table border="1"> <tr><th>A</th><th>B</th><th>C</th><th>D</th><th>E</th></tr> <tr><td>15,-</td><td>38,-</td><td>55,-</td><td>62,-</td><td>74,-</td></tr> <tr><th>F</th><th>G</th><th>H</th><th>I</th><th>L</th></tr> <tr><td>69,-</td><td>75,-</td><td>94,-</td><td>112,-</td><td>169,-</td></tr> </table>	A	B	C	D	E	15,-	38,-	55,-	62,-	74,-	F	G	H	I	L	69,-	75,-	94,-	112,-	169,-
	A	B	C	D	E																		
	15,-	38,-	55,-	62,-	74,-																		
F	G	H	I	L																			
69,-	75,-	94,-	112,-	169,-																			

Variante | Alternative

	649.15.550 Kupferrohr, 500 mm <ul style="list-style-type: none"> ■ mit Bördel, für Quetschverschraubung 	Copper tube, 500 mm <ul style="list-style-type: none"> ■ with flange, for compression joint 	<table border="1"> <tr><th>A</th><th>B</th><th>C</th><th>D</th><th>E</th></tr> <tr><td>20,-</td><td>58,-</td><td>77,-</td><td>87,-</td><td>102,-</td></tr> <tr><th>F</th><th>G</th><th>H</th><th>I</th><th>L</th></tr> <tr><td>97,-</td><td>77,-</td><td>96,-</td><td>134,-</td><td>219,-</td></tr> </table>	A	B	C	D	E	20,-	58,-	77,-	87,-	102,-	F	G	H	I	L	97,-	77,-	96,-	134,-	219,-
	A	B	C	D	E																		
	20,-	58,-	77,-	87,-	102,-																		
F	G	H	I	L																			
97,-	77,-	96,-	134,-	219,-																			

SERIE 1909

Maßzeichnungen unter www.joerger.de - Menü SERVICE.
 Technical specifications under www.joerger.de - menu SERVICE.

A chrom chrome	[.000]	E platin matt platinum matt	[.066]
B silbernickel polished nickel	[.035]	F nerz matt milk matt	[.096]
C nerz milk	[.095]	G schwarz-matt black matt	[.092]
C nickel matt satin nickel	[.036]	G weiß-matt white matt	[.052]
D edelmessing sunshine	[.040]	H bronze bronze	[.011]
D platin platinum	[.065]	I gold gold	[.020]
E edelmess.matt sunshine matt	[.041]	L roségold rosegold	[.022]
E gold matt gold matt	[.021]	L roségold matt rosegold matt	[.023]

	649.15.340 Waschtisch-Tassensiphon 1 1/4" <ul style="list-style-type: none"> schwere Ausführung Rosette Abgangsrohr ø 32 mm Tauchrohrlänge 165 mm 	Washbasin cupped siphon trap 1 1/4" <ul style="list-style-type: none"> heavy brass escutcheon outlet tube ø 32 mm dip pipe 165 mm 	A	B	C	D	E
			195,-	296,-	368,-	429,-	568,-
			F	G	H	I	L
			498,-	378,-	539,-	686,-	832,-

	649.15.330 Bidet-Tassensiphon 1 1/4" <ul style="list-style-type: none"> Rosette Abgangsrohr ø 32 mm 	Bidet cupped siphon trap 1 1/4" <ul style="list-style-type: none"> escutcheon outlet tube ø 32 mm 	A	B	C	D	E
			98,-	166,-	276,-	332,-	472,-
			F	G	H	I	L
			399,-	364,-	508,-	648,-	796,-

Badewanne, Stand-Batterien | Bath tub mixer sets, deck mount

	629.40.100 4-Loch Wannenfüll- und Brausebatterie 1/2" für Standmontage <ul style="list-style-type: none"> Ausladung 196 mm; Höhe 194 mm 2 Seitenrandventile mit keramischen Oberteilen 1/2" Metall-Brauseschlauch 2000 mm Metall-Handbrause mit Anti-Kalk-System und Rückflussverhinderer 	Tub/shower mixer set 1/2" deck mount <ul style="list-style-type: none"> spout projection 196 mm; height 194 mm 2 side valves with ceramic internal upper parts 1/2" metal shower hose 2000 mm metal hand shower with anticalc. system and backflow preventer 	A	B	C	D	E
			1.556,-	1.974,-	2.312,-	2.602,-	3.063,-
			F	G	H	I	L
			2.877,-	2.016,-	2.744,-	3.616,-	3.918,-

Empfohlen | Recommended

	649.40.160 Montageplatte, komplett <ul style="list-style-type: none"> für 4-Loch Armaturen Druckschläuche 1/2" x 1/2" x 600 mm empfohlen: Schlauchkastensystem siehe Kapitel "Serienübergreifendes" 	Assembly plate, complete <ul style="list-style-type: none"> for deck mounted tub/shower mixer pressure hoses 1/2"x 1/2" x 600 mm recommended: system with hose box see chapter "universal products" 	A				
			308,-				

	629.40.150 4-Loch Wannenrandkombination 1/2" <ul style="list-style-type: none"> für Ab- und Überlaufgarnitur mit Wanneneinlauf, ohne Rohrunterbrecher Seitenrandventile, 2-Wege Umstellung Metall-Brauseschlauch 2000 mm Metall-Handbrause mit Anti-Kalk-System und Rückflussverhinderer empfohlen: 649.40.160 - Montageplatte 	Tub/shower combination 1/2" <ul style="list-style-type: none"> for waste and overflow set with bath tub filler spout, without pipe interrupter side valves, 2-position diverter metal shower hose 2000 mm metal hand shower with anticalc. system and backflow preventer recommended: 649.40.160 - assembly plate 	A	B	C	D	E
			1.220,-	1.682,-	2.006,-	2.258,-	2.651,-
			F	G	H	I	L
			2.471,-	1.558,-	2.453,-	3.194,-	3.457,-

Badewanne, Aufputz-Batterien | Bath tub mixer sets, exposed

	629.20.100 Aufputz-Wannenfüll- und Brausebatterie 1/2", mit Garnitur <ul style="list-style-type: none"> Ausladung 145 mm Metall-Handbrause mit Anti-Kalk-System und Rückflussverhinderer Metall-Brauseschlauch 1500 mm 	Exposed tub/shower mixer 1/2", incl. shower set <ul style="list-style-type: none"> spout projection 145 mm metal hand shower with anticalc. system and backflow preventer metal shower hose 1500 mm 	A	B	C	D	E
			968,-	986,-	1.684,-	1.895,-	2.231,-
			F	G	H	I	L
			2.019,-	1.184,-	2.024,-	2.554,-	2.933,-

Optional | Optional

	649.20.170 Standanschluß (1 Paar) <ul style="list-style-type: none"> Wannenrandmontage, Höhe: 85 mm 	Pillar union (1 set) <ul style="list-style-type: none"> rim mounting, height: 85 mm 	A	B	C	D	E
			266,-	363,-	526,-	592,-	690,-
			F	G	H	I	L
			644,-	514,-	642,-	795,-	1.059,-

	649.20.175 Standanschluß (1 Paar) <ul style="list-style-type: none"> Wannenrandmontage, Höhe: 140 mm 	Pillar union (1 set) <ul style="list-style-type: none"> rim mounting, height: 140 mm 	A	B	C	D	E
			299,-	447,-	587,-	660,-	777,-
			F	G	H	I	L
			715,-	573,-	724,-	894,-	1.548,-

SERIE 1909

Maßzeichnungen unter www.joerger.de - Menü SERVICE.
 Technical specifications under www.joerger.de - menu SERVICE.

A chrom chrome	[.000]	E platin matt platinum matt	[.066]
B silbernickel polished nickel	[.035]	F nerz matt mink matt	[.096]
C nerz mink	[.095]	G schwarz-matt black matt	[.092]
C nickel matt satin nickel	[.036]	G weiß-matt white matt	[.052]
D edelmessing sunshine	[.040]	H bronze bronze	[.011]
D platin platinum	[.065]	I gold gold	[.020]
E edelmess.matt sunshine matt	[.041]	L roségold rosegold	[.022]
E gold matt gold matt	[.021]	L roségold matt rosegold matt	[.023]



629.20.140 Wannenfüll- und Brausebatterie für Standrohrmontage, mit Garnitur	Tub/shower mixer for supply pipes, incl. shower set
<ul style="list-style-type: none"> ■ Ausladung mit Standrohren 182 mm ■ Metall-Handbrause mit Anti-Kalk-System und Rückflussverhinderer ■ Metall-Brauseschlauch 1500 mm, einseitig mit drehbarem Konus 	<ul style="list-style-type: none"> ■ spout projection with pipes 182 mm ■ metal hand shower with anticalc. system and backflow preventer ■ metal shower hose 1500 mm, one side with turning cone

Benötigt | Required

109.15.260 Wasserzufuhrstandrohre 1/2"	Water supply pipes 1/2"
<ul style="list-style-type: none"> ■ 2 Stück, in Boden einzuschrauben ■ inkl. Winkelstück zum Anschluß der Wannenfüll- und Brausebatterie ■ Höhe 775 - 800 mm 	<ul style="list-style-type: none"> ■ 2 pieces, floor installation ■ incl. angle for connecting tub/shower mixer ■ height 775 - 800 mm

Empfohlen | Recommended

109.10.970 Bausatz-Vormontage	Assembly set for pre-installation
<ul style="list-style-type: none"> ■ Bodenplatte mit Befestigungsset ■ für Wasserzufuhrstandrohre 109.15.260 	<ul style="list-style-type: none"> ■ joint plate with fixing set ■ for water supply pipes 109.15.260



A	B	C	D	E
919,-	1.335,-	1.596,-	1.797,-	2.119,-
F	G	H	I	L
1.981,-	1.558,-	1.921,-	2.422,-	3.530,-
A	B	C	D	E
888,-	1.282,-	1.672,-	1.882,-	2.219,-
F	G	H	I	L
2.095,-	1.632,-	1.952,-	2.525,-	3.488,-
A				
459,-				

629.20.390 – Aufputz Set mit Steigrohr | Exposed set with shower system

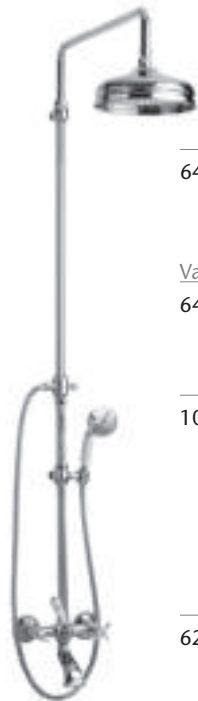

649.13.920 Regenbrause 1/2", ø 200 mm	Rain shower head 1/2", ø 200 mm
<ul style="list-style-type: none"> ■ Ausführung ganz in Metall ■ mit Kugelgelenk ■ Anti-Kalk-System 	<ul style="list-style-type: none"> ■ full metal body ■ with ball joint ■ with anticalcareous system

649.20.810 Steigrohr, Umstellung, Wandarm	Supply pipe, diverter, wall bracket
<ul style="list-style-type: none"> ■ zum Anschluß an die Brausebatterie ■ Ausladung 595-635 mm 	<ul style="list-style-type: none"> ■ to connect the exposed shower mixer ■ projection 595-635 mm

Variante | Alternative

649.20.830 Steigrohr, Umstellung, Wandarm	Supply pipe, diverter, wall bracket
<ul style="list-style-type: none"> ■ Ausladung 355-375 mm 	<ul style="list-style-type: none"> ■ projection 355-375 mm

109.13.700 Brausegarnitur	Shower combination
<ul style="list-style-type: none"> ■ Metall-Handbrause mit Anti-Kalk-System und Rückflussverhinderer ■ Brauseschlauch 1500 mm, beidseitig mit drehbarem Konus 	<ul style="list-style-type: none"> ■ metal hand shower with anticalc. system and backflow preventer ■ metal shower hose 1500 mm, both sides with turning cone

629.20.190 Aufputz-Wannenfüll- und Brausebatterie 1/2", ohne Garnitur	Exposed tub/shower mixer 1/2", without shower set
<ul style="list-style-type: none"> ■ für Steigrohr, Ausladung 145 mm ■ 2 keramische Oberteile 1/2" 	<ul style="list-style-type: none"> ■ for supply pipe, projection 145 mm ■ 2 ceramic internal upper parts 1/2"

A	B	C	D	E
260,-	619,-	824,-	895,-	1.268,-
F	G	H	I	L
1.085,-	821,-	1.098,-	1.389,-	2.189,-
A	B	C	D	E
1.029,-	1.315,-	1.849,-	2.072,-	2.889,-
F	G	H	I	L
2.560,-	2.052,-	2.760,-	3.247,-	3.624,-
A	B	C	D	E
226,-	396,-	416,-	467,-	569,-
F	G	H	I	L
508,-	544,-	745,-	832,-	1.328,-
A	B	C	D	E
846,-	1.239,-	1.472,-	1.657,-	1.951,-
F	G	H	I	L
1.807,-	1.439,-	1.769,-	2.235,-	3.257,-

Dusche, Aufputz-Batterien | Shower mixer sets, exposed



629.20.200 Brausebatterie 1/2" für Aufputzmontage	Exposed shower mixer 1/2"
<ul style="list-style-type: none"> ■ 2 keramische Oberteile 1/2" ■ Brauseabgang 3/4" ■ verdeckte S-Anschlüsse 1/2" x 3/4" 	<ul style="list-style-type: none"> ■ 2 ceramic internal upper parts 1/2" ■ discharge 3/4" ■ concealed S-connections 1/2" x 3/4"

A	B	C	D	E
489,-	647,-	772,-	870,-	1.023,-
F	G	H	I	L
928,-	796,-	1.068,-	1.305,-	2.096,-

SERIE 1909

Maßzeichnungen unter www.joerger.de - Menü SERVICE.
 Technical specifications under www.joerger.de - menu SERVICE.

A chrom chrome	[.000]	E platin matt platinum matt	[.066]
B silbernickel polished nickel	[.035]	F nerz matt milk matt	[.096]
C nerz milk	[.095]	G schwarz-matt black matt	[.092]
C nickel matt satin nickel	[.036]	G weiß-matt white matt	[.052]
D edelmessing sunshine	[.040]	H bronze bronze	[.011]
D platin platinum	[.065]	I gold gold	[.020]
E edelmess.matt sunshine matt	[.041]	L roségold rosegold	[.022]
E gold matt gold matt	[.021]	L roségold matt rosegold matt	[.023]

629.20.410 – Aufputz Set mit Steigrohr | Exposed set with shower system

	649.13.930 Regenbrause ½", ø 300 mm ■ Ausführung ganz in Metall ■ mit Kugelgelenk ■ Anti-Kalk-System	Rain shower head ½", ø 300 mm ■ full metal body ■ with ball joint ■ with anticalcareous system	A	B	C	D	E
			776,-	1.279,-	1.446,-	1.524,-	2.092,-
			F	G	H	I	L
			1.828,-	1.479,-	2.110,-	2.242,-	3.364,-
	649.13.920 Regenbrause ½", ø 200 mm ■ Ausführung ganz in Metall ■ mit Kugelgelenk ■ Anti-Kalk-System	Rain shower head ½", ø 200 mm ■ full metal body ■ with ball joint ■ with anticalcareous system	A	B	C	D	E
			260,-	619,-	824,-	895,-	1.268,-
			F	G	H	I	L
			1.085,-	821,-	1.098,-	1.389,-	2.189,-
	649.13.700 Steigrohr, Wandarm ■ zur Verbindung der Brausebatterie mit der Regenbrause ■ Ausladung Wandarm 368 mm, nicht verstellbar	Supply pipe, wall bracket ■ connects exposed shower mixer with rain shower head ■ projection wall bracket 368 mm, not flexible	A	B	C	D	E
			746,-	898,-	941,-	995,-	1.238,-
			F	G	H	I	L
			1.131,-	1.451,-	1.768,-	1.349,-	2.648,-
	629.20.210 Aufputz-Brausebatterie ½" ■ für Steigrohr ■ Brauseabgang ¾"	Exposed shower mixer ½" ■ for supply pipe ■ discharge ¾"	A	B	C	D	E
			489,-	647,-	772,-	870,-	1.023,-
			F	G	H	I	L
			928,-	794,-	1.068,-	1.305,-	2.096,-

629.20.411 – Aufputz Set mit Steigrohr | Exposed set with shower system

	649.13.930 Regenbrause ½", ø 300 mm ■ Ausführung ganz in Metall ■ mit Kugelgelenk ■ Anti-Kalk-System	Rain shower head ½", ø 300 mm ■ full metal body ■ with ball joint ■ with anticalcareous system	A	B	C	D	E
			776,-	1.279,-	1.446,-	1.524,-	2.092,-
			F	G	H	I	L
			1.828,-	1.479,-	2.110,-	2.242,-	3.364,-
	649.13.920 Regenbrause ½", ø 200 mm ■ Ausführung ganz in Metall ■ mit Kugelgelenk ■ Anti-Kalk-System	Rain shower head ½", ø 200 mm ■ full metal body ■ with ball joint ■ with anticalcareous system	A	B	C	D	E
			260,-	619,-	824,-	895,-	1.268,-
			F	G	H	I	L
			1.085,-	821,-	1.098,-	1.389,-	2.189,-
	649.13.705 Steigrohr, Wandarm, Umstellung ■ zur Verbindung der Regenbrause ■ Handbrause, Wandhalter ■ Ausladung Wandarm 368 mm, nicht verstellbar	Supply pipe, wall bracket, diverter ■ connects mixer with rain shower head ■ handshower, wall bracket ■ projection wall bracket 368 mm, not flexible	A	B	C	D	E
			1.136,-	1.458,-	1.587,-	1.699,-	2.179,-
			F	G	H	I	L
			1.971,-	1.743,-	2.035,-	2.399,-	2.918,-
	629.20.210 Aufputz-Brausebatterie ½" ■ für Steigrohr ■ Brauseabgang ¾"	Exposed shower mixer ½" ■ for supply pipe ■ discharge ¾"	A	B	C	D	E
			489,-	647,-	772,-	870,-	1.023,-
			F	G	H	I	L
			928,-	794,-	1.068,-	1.305,-	2.096,-
	629.20.250 Brausethermostat ½" für Aufputzmontage ■ Dehnstoff-Thermoelement ■ Sicherheitssperre bei 38° C ■ Keramik-Innenoberteil ½"	Exposed shower thermostat ½" ■ cartridge with thermoelement ■ heat scale and locking device at 38°C ■ ceramic cartridge ½"	A	B	C	D	E
			929,-	1.262,-	1.399,-	1.499,-	2.029,-
			F	G	H	I	L
			1.815,-	1.476,-	1.819,-	2.275,-	2.678,-

SERIE 1909

Maßzeichnungen unter www.joerger.de - Menü SERVICE.
 Technical specifications under www.joerger.de - menu SERVICE.

A chrom chrome	[.000]	E platin matt platinum matt	[.066]
B silbernickel polished nickel	[.035]	F nerz matt milk matt	[.096]
C nerz milk	[.095]	G schwarz-matt black matt	[.092]
C nickel matt satin nickel	[.036]	G weiß-matt white matt	[.052]
D edelmessing sunshine	[.040]	H bronze bronze	[.011]
D platin platinum	[.065]	I gold gold	[.020]
E edelmess.matt sunshine matt	[.041]	L roségold rosegold	[.022]
E gold matt gold matt	[.021]	L roségold matt rosegold matt	[.023]

629.20.460 – Aufputz Set mit Steigrohr | Exposed set with shower system

	649.13.920 Regenbrause ½", ø 200 mm	Rain shower head ½", ø 200 mm	A	B	C	D	E
	<ul style="list-style-type: none"> ■ Ausführung ganz in Metall ■ mit Kugelgelenk ■ Anti-Kalk-System 	<ul style="list-style-type: none"> ■ full metal body ■ with ball joint ■ with anticalcareous system 	260,-	619,-	824,-	895,-	1.268,-
			F	G	H	I	L
			1.085,-	821,-	1.098,-	1.389,-	2.189,-
	649.20.280 Steigrohr, Umstellung, Wandarm	Supply pipe, diverter, wall bracket	A	B	C	D	E
	<ul style="list-style-type: none"> ■ zum Anschluß an die Brausebatterie ■ Ausladung 360-380 mm ■ in der Neigung und Höhe verstellbare Brausehalterung 	<ul style="list-style-type: none"> ■ to connect the exposed shower mixer ■ projection 360-38 mm ■ fitting for handshower adjustable in height and inclination 	589,-	932,-	1.198,-	1.362,-	1.741,-
			F	G	H	I	L
			1.599,-	1.318,-	1.649,-	1.895,-	2.529,-
	109.13.700 Brausegarnitur	Shower combination	A	B	C	D	E
	<ul style="list-style-type: none"> ■ Metall-Handbrause mit Anti-Kalk-System und Rückflussverhinderer ■ Brauseschlauch 1.500 mm, einseitig mit drehbarem Konus 	<ul style="list-style-type: none"> ■ metal hand shower with anticalc. system and backflow preventer ■ metal shower hose 1.500 mm, one side with turning cone 	226,-	396,-	416,-	467,-	569,-
			F	G	H	I	L
			508,-	544,-	745,-	832,-	1.328,-
	629.20.260 Aufputz-Brausethermostat ½"	Exposed shower thermostat ½"	A	B	C	D	E
	<ul style="list-style-type: none"> ■ für Steigrohr ■ Brauseabgang ¾" 	<ul style="list-style-type: none"> ■ for supply pipe ■ discharge ¾" 	977,-	1.310,-	1.447,-	1.547,-	2.077,-
			F	G	H	I	L
			1.863,-	1.524,-	1.867,-	2.323,-	2.726,-

Unterputz-Thermostate ½" | Wall thermostats, concealed ½"

	629.40.380 Unterputz-Thermostat ½" mit Mengenregulierung, Fertigmontageset	Concealed wall thermostat ½" with flow control, assembly set	A	B	C	D	E
	<ul style="list-style-type: none"> ■ manuelle, keramische Umstellung Wanne/Brause, druckunabhängig ■ mit Sicherheitseinrichtung ■ Durchflußrate 20,4 l/min bei 3 bar 	<ul style="list-style-type: none"> ■ manual, ceramic diverter tub/shower for pressure-independent function ■ with safety device ■ flow rate 20,4 l/min at 3 bar 	1.108,-	1.196,-	1.525,-	1.565,-	1.863,-
			F	G	H	I	L
			1.716,-	1.305,-	1.790,-	2.035,-	2.360,-
Variante Alternative			A	B	C	D	E
	629.40.360 Unterputz-Thermostat ½" mit Mengenregulierung, Fertigmontageset	Concealed wall thermostat ½" with flow control, assembly set	A	B	C	D	E
	<ul style="list-style-type: none"> ■ ohne Umstellung ■ mit integrierter keramischer Mengenregulierung ■ Durchflußrate 20,4 l/min bei 3 bar 	<ul style="list-style-type: none"> ■ without diverter ■ with integrated ceramic cartridge for volume control ■ flow rate 20,4 l/min at 3 bar 	1.035,-	1.176,-	1.490,-	1.530,-	1.827,-
			F	G	H	I	L
			1.716,-	1.276,-	1.754,-	1.999,-	2.308,-
Variante Alternative			A	B	C	D	E
	600.40.460 Unterputz-Thermostat ½" ohne Mengenregulierung, Fertigmontageset	Concealed wall thermostat ½" without flow control, assembly set	A	B	C	D	E
	<ul style="list-style-type: none"> ■ Funktionseinheit ohne Umstellung und ohne Absperrung ■ Durchflußrate 25,8 l/min bei 3 bar 	<ul style="list-style-type: none"> ■ Functional unit without diverter and without shut-off ■ flow rate 25,8 l/min at 3 bar 	884,-	984,-	1.246,-	1.276,-	1.548,-
			F	G	H	I	L
			1.431,-	1.051,-	1.488,-	1.707,-	1.919,-
Benötigt Required			A				
	649.40.360 Unterputz-Einbaubox ½"	Concealed wall box ½"	A				
	<ul style="list-style-type: none"> ■ zu Fertigmontageset 629.40.360, 629.40.380 und 600.40.460 ■ für Nass- und Trockenbau geeignet 	<ul style="list-style-type: none"> ■ for assembly set 629.40.360, 629.40.380 and 600.40.460 ■ for wetwall and drywall construction 	168,-				

SERIE 1909

Maßzeichnungen unter www.joerger.de - Menü SERVICE.
 Technical specifications under www.joerger.de - menu SERVICE.

A chrom chrome	[.000]	E platin matt platinum matt	[.066]
B silbernickel polished nickel	[.035]	F nerz matt milk matt	[.096]
C nerz milk	[.095]	G schwarz-matt black matt	[.092]
C nickel matt satin nickel	[.036]	G weiß-matt white matt	[.052]
D edelmessing sunshine	[.040]	H bronze bronze	[.011]
D platin platinum	[.065]	I gold gold	[.020]
E edelmess.matt sunshine matt	[.041]	L roségold rosegold	[.022]
E gold matt gold matt	[.021]	L roségold matt rosegold matt	[.023]

Unterputz-Thermostat ¾" mit hohem Durchfluß | Wall thermostat, concealed ¾" with high flow



- 629.40.560 Unterputz-Thermostat ¾" **ohne** Mengenregulierung, Fertigmontageset
- serienbezogener Temperiergriff
 - Sicherheitssperre bei 38° C

- Concealed wall thermostat ¾" **without** flow control, assembly set
- design handle for temp. control
 - locking device at 38°C

A	B	C	D	E
535,-	588,-	995,-	1.039,-	1.348,-
F	G	H	I	L
1.237,-	658,-	1.467,-	1.583,-	1.909,-

Benötigt | Required



- 649.40.555 Unterputz-Einbaukörper ¾"
- zu Fertigmontageset 629.40.555
 - Kartusche mit Schmutzfangsieben
 - für Nass- und Trockenbau geeignet
 - Durchflußrate 64,2 l/min bei 3 bar
 - **ohne** Absperrung

- Concealed thermostat body ¾"
- for assembly set 629.40.555
 - cartridge with filter screens
 - for wetwall and drywall construction
 - flow rate 64,2 l/min at 3 bar
 - **without** shut-off

A	B	C	D	E
1.636,-				

Unterputz-Thermostat ¾" | Wall thermostat, concealed ¾"



- 629.40.520 Unterputz-Thermostat ¾" **ohne** Mengenregulierung, Fertigmontageset
- serienbezogener Temperiergriff
 - Sicherheitssperre bei 38° C

- Concealed wall thermostat ¾" **without** flow control, assembly set
- design handle for temp. control
 - locking device at 38°C

A	B	C	D	E
535,-	588,-	995,-	1.039,-	1.348,-
F	G	H	I	L
1.237,-	658,-	1.467,-	1.583,-	1.909,-

Benötigt | Required



- 649.40.520 Unterputz-Einbaukörper ¾"
- zu Fertigmontageset 629.40.520
 - Kartusche mit Schmutzfangsieben
 - für Nass- und Trockenbau geeignet
 - Durchflußrate 41 l/min bei 3 bar
 - **ohne** Absperrung

- Concealed thermostat body ¾"
- for assembly set 629.40.520
 - cartridge with filter screens
 - for wetwall and drywall construction
 - flow rate 41 l/min at 3 bar
 - **without** shut-off

A	B	C	D	E
498,-				

Unterputz-Thermostat/Ventil-Modul | Concealed thermostatic/wall-valve modul



- 629.60.432 Unterputz-Ventil-Modul Fertigmontageset
- Griff
 - Rosette

- Concealed wall-valve-modul assembly set
- design handle
 - escutcheon

A	B	C	D	E
235,-	242,-	374,-	421,-	495,-
F	G	H	I	L
460,-	251,-	441,-	606,-	671,-

Benötigt | Required



- 649.20.610 Unterputz-Ventil-Modul, 1-fach
- 1x Spindelventil ¾", rechtsschließend mit keram. Scheiben
 - 2 Abgänge ½", je 1x rechts/links möglich, gleichzeitig benutzbar

- Concealed wall-valve-modul, single
- 1x spindle valve ¾", clockwise closure with ceramic discs
 - 2 outlets ½", each 1x right/left possible, simultaneously usable

A	B	C	D	E
229,-				



- 649.20.620 Unterputz-Ventil-Modul, 2-fach
- 2x Spindelventil ¾", rechtsschließend mit keram. Scheiben
 - 4 Abgänge ½", je 2x rechts/links möglich, gleichzeitig benutzbar
 - im Verbund maßgenaue Montage
 - erweiterbar mit 649.20.610

- Concealed wall-valve-modul, double
- 2x spindle valve ¾", clockwise closure with ceramic discs
 - 4 outlets ½", each 2x right/left possible, simultaneously usable
 - precise assembly due to composite
 - expandable with 649.20.610

A	B	C	D	E
458,-				



- 649.20.630 Unterputz-Ventil-Modul, 3-fach
- 3x Spindelventil ¾", rechtsschließend mit keram. Scheiben
 - 6 Abgänge ½", je 3x rechts/links möglich, gleichzeitig benutzbar
 - im Verbund maßgenauen Montage
 - erweiterbar mit 649.20.610

- Concealed wall-valve-modul, triple
- 3x spindle valve ¾", clockwise closure with ceramic discs
 - 6 outlets ½", each 3x right/left possible, simultaneously usable
 - precise assembly due to composite
 - expandable with 649.20.610

A	B	C	D	E
686,-				

SERIE 1909

Maßzeichnungen unter www.joerger.de - Menü SERVICE.
 Technical specifications under www.joerger.de - menu SERVICE.

A chrom chrome	[.000]	E platin matt platinum matt	[.066]
B silbernickel polished nickel	[.035]	F nerz matt mink matt	[.096]
C nerz mink	[.095]	G schwarz-matt black matt	[.092]
C nickel matt satin nickel	[.036]	G weiß-matt white matt	[.052]
D edelmessing sunshine	[.040]	H bronze bronze	[.011]
D platin platinum	[.065]	I gold gold	[.020]
E edelmess.matt sunshine matt	[.041]	L roségold rosegold	[.022]
E gold matt gold matt	[.021]	L roségold matt rosegold matt	[.023]

	600.40.460 Unterputz-Thermostat 1/2" ohne Mengenregulierung, Fertigmontageset <ul style="list-style-type: none"> ■ Funktionseinheit <u>ohne</u> Umstellung und <u>ohne</u> Absperrung ■ Durchflussrate 25,8 l/min bei 3 bar 	Concealed wall thermostat 1/2" without flow control, assembly set <ul style="list-style-type: none"> ■ Functional unit <u>without</u> diverter and <u>without</u> shut-off ■ flow rate 25,8 l/min at 3 bar 	A	B	C	D	E
			884,-	984,-	1.246,-	1.276,-	1.548,-
			F	G	H	I	L
			1.431,-	1.051,-	1.488,-	1.707,-	1.919,-

Benötigt | Required

	649.20.612 Anschlußadapter 1/2" <ul style="list-style-type: none"> ■ Anschlußadapter, Abschlußstopfen ■ passend zu Einbaubox 649.40.360 	Connection adapter 1/2" <ul style="list-style-type: none"> ■ connection adapter, end plug ■ matching to wall box 649.40.360 	A				
			122,-				

	649.40.360 Unterputz-Einbaubox 1/2" <ul style="list-style-type: none"> ■ zu Fertigmontageset 600.40.460 ■ für Nass- und Trockenbau geeignet 	Concealed wall box 1/2" <ul style="list-style-type: none"> ■ for assembly set 600.40.460 ■ for wetwall and drywall construction 	A				
			168,-				

	629.40.560 Unterputz-Thermostat 3/4" ohne Mengenregulierung, Fertigmontageset <ul style="list-style-type: none"> ■ serienbezogener Temperiergriff ■ Sicherheitssperre bei 38° C 	Concealed wall thermostat 3/4" without flow control, assembly set <ul style="list-style-type: none"> ■ design handle for temp. control ■ locking device at 38° C 	A	B	C	D	E
			535,-	588,-	995,-	1.039,-	1.348,-
			F	G	H	I	L
			1.237,-	658,-	1.467,-	1.583,-	1.909,-

Benötigt | Required

	649.20.634 Anschlußadapter 3/4" <ul style="list-style-type: none"> ■ Anschlußadapter, Abschlußstopfen ■ passend zu Einbaukörper 649.40.555 	Connection adapter 3/4" <ul style="list-style-type: none"> ■ connection adapter, end plug ■ matching to wall body 649.40.555 	A				
			146,-				

	649.40.555 Unterputz-Einbaukörper 3/4" <ul style="list-style-type: none"> ■ zu Fertigmontageset 629.40.555 ■ Kartusche mit Schmutzfangsieben ■ für Nass- und Trockenbau geeignet ■ Durchflussrate 64,2 l/min bei 3 bar ■ <u>ohne</u> Absperrung 	Concealed thermostat body 3/4" <ul style="list-style-type: none"> ■ for assembly set 629.40.555 ■ cartridge with filter screens ■ for wetwall and drywall construction ■ flow rate 64,2 l/min at 3 bar ■ <u>without</u> shut-off 	A				
			1.636,-				

Unterputz-Ventile | Valves, concealed

	629.50.234 Unterputz-Ventil Fertigmontageset <ul style="list-style-type: none"> ■ Griff ■ Hülse, Schubrosette 	Concealed wall valve assembly set <ul style="list-style-type: none"> ■ design handle ■ socket with adjustable escutcheon 	A	B	C	D	E
			184,-	252,-	294,-	331,-	391,-
			F	G	H	I	L
			366,-	270,-	369,-	476,-	569,-

Benötigt | Required

	649.20.340 Unterputz-Ventil 1/2", Einbaukörper <ul style="list-style-type: none"> ■ rechtsschließend, ker. Scheiben 	Concealed wall valve 1/2", body <ul style="list-style-type: none"> ■ clockwise closure, ceramic discs 	A				
			62,-				

	649.20.345 Unterputz-Ventil 1/2", Einbaukörper <ul style="list-style-type: none"> ■ linksschließend, ker. Scheiben 	Concealed wall valve 1/2", body <ul style="list-style-type: none"> ■ counter-clockwise closure, cer. discs 					
---	---	--	--	--	--	--	--

	649.20.440 Unterputz-Ventil 3/4", Einbaukörper <ul style="list-style-type: none"> ■ rechtsschließend, ker. Scheiben 	Concealed wall valve 3/4", body <ul style="list-style-type: none"> ■ clockwise closure, ceramic discs 	A				
			106,-				

	649.20.445 Unterputz-Ventil 3/4", Einbaukörper <ul style="list-style-type: none"> ■ linksschließend, ker. Scheiben 	Concealed wall valve 3/4", body <ul style="list-style-type: none"> ■ counter-clockwise closure, cer. discs 					
---	---	--	--	--	--	--	--

SERIE 1909

Maßzeichnungen unter www.joerger.de - Menü SERVICE.
 Technical specifications under www.joerger.de - menu SERVICE.

A chrom chrome	[.000]	E platin matt platinum matt	[.066]
B silbernickel polished nickel	[.035]	F nerz matt mink matt	[.096]
C nerz mink	[.095]	G schwarz-matt black matt	[.092]
C nickel matt satin nickel	[.036]	G weiß-matt white matt	[.052]
D edelmessing sunshine	[.040]	H bronze bronze	[.011]
D platin platinum	[.065]	I gold gold	[.020]
E edelmess.matt sunshine matt	[.041]	L roségold rosegold	[.022]
E gold matt gold matt	[.021]	L roségold matt rosegold matt	[.023]

Unterputz-Umstellung | Diverter concealed



629.40.650 Unterputz 3-Wege Umstellung ½" Fertigmontageset

- Griff
- Hülse, Schubrosette

Concealed 3-position diverter ½" assembly set

- design handle
- socket with adjustable escutcheon

A	B	C	D	E
235,-	265,-	374,-	421,-	495,-
F	G	H	I	L
462,-	280,-	441,-	606,-	678,-

Benötigt | Required



649.40.600 Unterputz 3-Wege Umstellung ½" Einbaukörper

- zu Fertigmontageset 629.40.650

Concealed 3-position diverter ½" diverter body

- for assembly set 629.40.650

A	B	C	D	E
236,-				

Brausen | Showers



629.13.300 Duschgarnitur, komplett

- Wandrohr 850 mm, mit Schieber
- Metall-Handbrause mit Anti-Kalk-System und Rückflussverhinderer
- Metall-Brauseschlauch 1750 mm, einseitig mit drehbarem Konus

Shower bar set, complete

- wall bar 850 mm, with slider
- metal hand shower with anticalc. system and backflow preventer
- metal shower hose 1750 mm, one side with turning cone

A	B	C	D	E
564,-	732,-	798,-	1.068,-	1.438,-
F	G	H	I	L
1.279,-	1.234,-	1.726,-	1.609,-	3.051,-

629.13.350 Duschstange, lose

- Wandrohr 850 mm, mit Schieber

Shower bar, separate

- wall bar 850 mm, with slider

A	B	C	D	E
458,-	632,-	674,-	759,-	992,-
F	G	H	I	L
891,-	727,-	904,-	1.098,-	1.868,-

629.13.200 Schlauchbrausegarnitur

- Wandanschlußbogen ½"
- Wand-Brausehalter
- Metall-Handbrause mit Anti-Kalk-System und Rückflussverhinderer
- Metall-Brauseschlauch 1500 mm, beidseitig mit drehbarem Konus

Shower combination

- Wall elbow connection ½"
- Wall fitting for hand shower
- metal hand shower with anticalc. system and backflow preventer
- flexible metal shower hose 1500 mm, both sides with turning cone

A	B	C	D	E
384,-	464,-	643,-	724,-	850,-
F	G	H	I	L
769,-	756,-	1.075,-	982,-	1.607,-



629.13.150 Wandanschlußbogen ½", ohne Haken

- Brauseabgang ½"
- mit Rückflussverhinderer, Rosette

Wall elbow connection ½", without cradle

- discharge ½"
- with backflow preventer, escutcheon

A	B	C	D	E
95,-	108,-	126,-	141,-	168,-
F	G	H	I	L
155,-	155,-	195,-	194,-	311,-



649.13.210 Wand-Brausehalter

Wall fitting for hand shower

A	B	C	D	E
178,-	214,-	266,-	287,-	337,-
F	G	H	I	L
299,-	256,-	325,-	374,-	459,-



SERIE 1909

Maßzeichnungen unter www.joerger.de - Menü SERVICE.
 Technical specifications under www.joerger.de - menu SERVICE.

A chrom chrome	[.000]	E platin matt platinum matt	[.066]
B silbernickel polished nickel	[.035]	F nerz matt milk matt	[.096]
C nerz milk	[.095]	G schwarz-matt black matt	[.092]
C nickel matt satin nickel	[.036]	G weiß-matt white matt	[.052]
D edelmessing sunshine	[.040]	H bronze bronze	[.011]
D platin platinum	[.065]	I gold gold	[.020]
E edelmess.matt sunshine matt	[.041]	L roségold rosegold	[.022]
E gold matt gold matt	[.021]	L roségold matt rosegold matt	[.023]







	629.13.237 Hygienebrausegarnitur <ul style="list-style-type: none"> Wandbrausehalter und -anschlußbogen ½", Schubrosette Hygienebrause, klassisch (649.13.338), komplett aus Metall einstrahlig, Bedienung über Druckhebel Metall-Brauseschlauch 1250 mm 	Ablution spray combination <ul style="list-style-type: none"> wall fitting and elbow connection ½" spray handshower, classical (649.13.338), completely metal one jet, push-lever operation flexible metal shower hose 1250 mm 	A	B	C	D	E
			309,-	442,-	612,-	641,-	859,-
	629.20.237 1-Hand Batterie ½" für Hygiene-Brause, Fertigmontageset <ul style="list-style-type: none"> Rosette, Griff mit Hebelgriff 	Concealed single lever ½" for ablu-tion spray, assembly set <ul style="list-style-type: none"> escutcheon, handle with lever handle 	A	B	C	D	E
			259,-	384,-	430,-	483,-	567,-
<p>Benötigt Required</p>			F	G	H	I	L
			737,-	670,-	996,-	1.101,-	1.528,-
	649.20.237 Unterputz 1-Hand Batterie ½", Einbaukörper <ul style="list-style-type: none"> Kartusche mit keramischen Scheiben zu Fertigmontageset 629.20.237 	Single lever mixer ½", concealed body <ul style="list-style-type: none"> cartridge with ceramic discs for assembly set 629.20.237 	A	B	C	D	E
			125,-	169,-	208,-	229,-	268,-
			F	G	H	I	L
			249,-	224,-	258,-	329,-	396,-
	649.13.615 Stachelkopfbrause ½" <ul style="list-style-type: none"> ø 230 mm, 75 Düsen Ausführung ganz in Metall Anti-Kalk-System Brausekopf schwenkbar <u>ohne Wandarm</u> 	Body spray shower head ½" <ul style="list-style-type: none"> ø 230 mm, 75 jets full metal body anticalcareous system swivel shower head <u>without wall bracket</u> 	A	B	C	D	E
			969,-	1.232,-	1.359,-	1.416,-	1.659,-
			F	G	H	I	L
			1.496,-	1.399,-	1.718,-	2.262,-	2.739,-
<p>Empfohlen Recommended</p>							
	649.13.625 Wandarm ½" <ul style="list-style-type: none"> Ausladung 162 mm 	Wall bracket ½" <ul style="list-style-type: none"> projection 162 mm 	A	B	C	D	E
			126,-	145,-	171,-	189,-	250,-
			F	G	H	I	L
			229,-	192,-	296,-	286,-	499,-
	649.13.519 Seitenbrause ½" <ul style="list-style-type: none"> Rosette ø 130 mm, Wandmontage Brausekopf schwenkbar, 20° Anti-Kalk-System Ausführung Kunststoff 	Body spray side shower ½" <ul style="list-style-type: none"> escutcheon ø 130 mm, wall assembly swivel shower head, 20° anticalcareous system plastic 	A	B	C	D	E
			167,-	326,-	385,-	399,-	542,-
			F	G	H	I	L
			496,-	376,-	472,-	634,-	949,-
	649.13.395 Handbrause ½" <ul style="list-style-type: none"> Anti-Kalk-System 3 Strahlarten: Normal, Massage, Soft Anschluß ½" 	Hand shower ½" <ul style="list-style-type: none"> anticalcareous system with 3 jets: normal, hydromassage, soft connection ½" 	A	B	C	D	E
			165,-	239,-	299,-	349,-	509,-
			F	G	H	I	L
			418,-	297,-	436,-	648,-	856,-

SERIE 1909

Maßzeichnungen unter www.joerger.de - Menü SERVICE.
 Technical specifications under www.joerger.de - menu SERVICE.

A chrom chrome	[.000]	E platin matt platinum matt	[.066]
B silbernickel polished nickel	[.035]	F nerz matt milk matt	[.096]
C nerz milk	[.095]	G schwarz-matt black matt	[.092]
C nickel matt satin nickel	[.036]	G weiß-matt white matt	[.052]
D edelmessing sunshine	[.040]	H bronze bronze	[.011]
D platin platinum	[.065]	I gold gold	[.020]
E edelmess.matt sunshine matt	[.041]	L roségold rosegold	[.022]
E gold matt gold matt	[.021]	L roségold matt rosegold matt	[.023]

Accessoires für Handtücher | Accessories for towels

	629.00.002 Handtuchhalter, doppelt ■ Rohre schwenkbar ■ ca. 410 mm	Double towel bar ■ swivelling bars ■ approx. 410 mm	A	B	C	D	E
			212,-	305,-	356,-	384,-	514,-
			F	G	H	I	L
			459,-	434,-	559,-	574,-	1.043,-
	629.00.047 Handtuchring ■ ø ca. 220 mm ■ geschlossene Ausführung	Towel ring ■ ø approx. 220 mm ■ closed version	A	B	C	D	E
			188,-	215,-	224,-	232,-	280,-
			F	G	H	I	L
			258,-	333,-	415,-	306,-	771,-
	629.00.022 Handtuchhaken	Robe hanger	A	B	C	D	E
			72,-	86,-	89,-	97,-	116,-
			F	G	H	I	L
			104,-	124,-	142,-	141,-	214,-
	629.00.040 Badetuchhalter ■ ca. 710 mm	Bath towel bar ■ approx. 710 mm	A	B	C	D	E
			238,-	338,-	394,-	442,-	562,-
			F	G	H	I	L
			502,-	423,-	698,-	626,-	1.513,-
	629.00.031 Wannengriff ■ ca. 410 mm	Tub handle ■ approx. 410 mm	A	B	C	D	E
			198,-	294,-	348,-	374,-	506,-
			F	G	H	I	L
			448,-	368,-	498,-	564,-	954,-
	629.00.104 Gästehandtuchkorb, eckig ■ mit Ablage ■ Korbgröße 260 x 150 x 190 mm	Guest towel basket, angular ■ with shelf ■ basket size 260 x 150 x 190 mm	A	B	C	D	E
			378,-	455,-	652,-	734,-	866,-
			F	G	H	I	L
			819,-	550,-	966,-	1.073,-	1.874,-









Accessoires für Waschplatz | Accessories for washstands

	629.00.007 Seifenhalter, komplett ■ Seifenschale aus Keramik, Handarbeit	Soap dish holder, complete ■ ceramic dish, hand made	A	B	C	D	E
			149,-	164,-	196,-	221,-	261,-
			F	G	H	I	L
			246,-	244,-	299,-	323,-	440,-
			A				
729.00.307 Keramik-Seifenschale, lose ■ Seifenschale, Handarbeit			63,-				

SERIE 1909

Maßzeichnungen unter www.joerger.de - Menü SERVICE.
 Technical specifications under www.joerger.de - menu SERVICE.

A chrom chrome	[.000]	E platin matt platinum matt	[.066]
B silbernickel polished nickel	[.035]	F nerz matt milk matt	[.096]
C nerz milk	[.095]	G schwarz-matt black matt	[.092]
C nickel matt satin nickel	[.036]	G weiß-matt white matt	[.052]
D edelmessing sunshine	[.040]	H bronze bronze	[.011]
D platin platinum	[.065]	I gold gold	[.020]
E edelmess.matt sunshine matt	[.041]	L roségold rosegold	[.022]
E gold matt gold matt	[.021]	L roségold matt rosegold matt	[.023]

	109.00.017 Seifenhalter, komplett ■ Standmodell ■ Seifenschale aus Kristallglas	Soap dish holder, complete ■ free standing version ■ crystal glass dish	A	B	C	D	E
			189,-	232,-	278,-	296,-	345,-
			F	G	H	I	L
			322,-	279,-	296,-	410,-	594,-
	629.00.006 Lotionsspender, komplett	Soap dispenser, complete	A	B	C	D	E
			259,-	285,-	348,-	391,-	461,-
			F	G	H	I	L
			431,-	375,-	454,-	572,-	781,-
	713.00.306 Lotionsspenderglas, lose ■ seidenmatt, ohne Pumpe	Soap dispenser glass, separate ■ frosted, without pump	A				
			78,-				
	109.00.016 Lotionsspender, komplett ■ Standmodell ■ Glas aus Kristallglas, seidenmatt	Soap dispenser, complete ■ free standing version ■ crystal glass, frosted	A	B	C	D	E
			246,-	294,-	329,-	365,-	434,-
			F	G	H	I	L
			399,-	366,-	424,-	497,-	717,-
	629.00.105 Schwammkorb ■ rechteckig, 260 x 130 mm	Sponge basket ■ rectangular, 260 x 130 mm	A	B	C	D	E
			337,-	442,-	492,-	522,-	674,-
			F	G	H	I	L
			607,-	538,-	728,-	744,-	1.235,-
	629.00.106 Eckschwammkorb ■ 195 x 195 mm	Corner sponge basket ■ 195 x 195 mm	A	B	C	D	E
			278,-	360,-	399,-	449,-	545,-
			F	G	H	I	L
			492,-	493,-	614,-	620,-	1.106,-
	629.00.036 Becherhalter, komplett ■ Becher aus Keramik, Handarbeit	Tumbler holder, complete ■ ceramic tumbler, hand made	A	B	C	D	E
			169,-	184,-	191,-	214,-	253,-
			F	G	H	I	L
			236,-	252,-	352,-	312,-	556,-
	729.00.336 Keramik-Becher, lose ■ Becher aus Keramik, Handarbeit	Ceramic tumbler, separate ■ ceramic tumbler, hand made	A				
			86,-				
	109.00.046 Glashalter, komplett ■ Standmodell ■ Glas aus Kristallglas, seidenmatt	Tumbler holder, complete ■ free standing version ■ crystal glass tumbler, frosted	A	B	C	D	E
			196,-	238,-	285,-	302,-	352,-
			F	G	H	I	L
			329,-	286,-	306,-	417,-	599,-

SERIE 1909

Maßzeichnungen unter www.joerger.de - Menü SERVICE.
 Technical specifications under www.joerger.de - menu SERVICE.

A chrom chrome	[.000]	E platin matt platinum matt	[.066]
B silbernickel polished nickel	[.035]	F nerz matt milk matt	[.096]
C nerz milk	[.095]	G schwarz-matt black matt	[.092]
C nickel matt satin nickel	[.036]	G weiß-matt white matt	[.052]
D edelmessing sunshine	[.040]	H bronze bronze	[.011]
D platin platinum	[.065]	I gold gold	[.020]
E edelmess.matt sunshine matt	[.041]	L roségold rosegold	[.022]
E gold matt gold matt	[.021]	L roségold matt rosegold matt	[.023]

	629.00.009 Ablage, 600 mm ■ Glasplatte aus Kristallglas	Shelf holder with glass, 600 mm ■ crystal glass shelf	A	B	C	D	E
			259,-	312,-	389,-	437,-	514,-
			F	G	H	I	L
			485,-	398,-	498,-	607,-	886,-

Accessoires für WC-Bereich | Accessories for w.c. area

	629.00.014 Papierhalter ■ mit Deckel	Toilet paper roll holder ■ with lid	A	B	C	D	E
			159,-	194,-	239,-	263,-	359,-
			F	G	H	I	L
			317,-	312,-	495,-	405,-	978,-

	629.00.015 Reserve-Papierhalter	Spare toilet paper roll holder	A	B	C	D	E
			124,-	159,-	175,-	185,-	236,-
			F	G	H	I	L
			214,-	203,-	312,-	260,-	555,-

	629.00.000 Klosettbürstengarnitur, komplett ■ stehendes Modell ■ Bürstentopf aus Keramik, Handarbeit	Toilet brush holder set, complete ■ floor standing model ■ ceramic brush holder, hand made	A	B	C	D	E
			439,-	458,-	462,-	467,-	550,-
			F	G	H	I	L
			478,-	676,-	898,-	668,-	899,-

	629.00.053 Bürstenstange komplett, lose	Brush rod with brush, separate	A	B	C	D	E
			118,-	195,-	199,-	224,-	265,-
			F	G	H	I	L
			237,-	178,-	251,-	324,-	379,-

799.00.236 Bürstenkopf, lose	Brush, separate	A				
		22,-				

Spiegel und Leuchten | Mirrors and lamps

	109.00.061 Wandleuchte, komplett Leuchtenglas matt ■ mit Leuchtmittel, 40 W	Wall lamp, complete Glass frosted ■ light bulb included, 40 W	A	B	C	D	E
			459,-	549,-	711,-	799,-	942,-
			F	G	H	I	L
			859,-	709,-	926,-	1.096,-	1.634,-

109.00.361 Leuchtenglas, lose ■ Leuchtenglas matt	Glass, separate ■ glass frosted	A				
		119,-				

	649.00.414 Kosmetikspiegel, beleuchtet ■ schwenk- und ausziehbar ■ 3-fache Vergrößerung ■ Direktanschluss ■ Spiegeldurchmesser 185 mm ■ Rahmendurchmesser 250 mm ■ Kalt-, Warm- und Taglicht durch Piezzo-Schalter umschaltbar	Cosmetic mirror, incl. lighting ■ swivelling and extendable ■ magnification 3:1 ■ direct connection ■ mirror diameter 185 mm ■ frame diameter 250 mm ■ cold, warm and day light switchable by Piezzo switch	A	B	C	D	E
			556,-	988,-	1.214,-	1.418,-	1.828,-
			F	G	H	I	L
			1.684,-	1.214,-	1.549,-	2.138,-	2.998,-





Oberflächen | colours

Folgende Oberflächen sind bei dieser Serie möglich |
The following colours are possible with this collection

chrom	chrome	[.000]	PG A
silbernickel	polished nickel	[.035]	PG B
nerz	mink	[.095]	PG C
nickel matt	satin nickel	[.036]	PG C
edelmessing	sunshine	[.040]	PG D
platin	platinum	[.065]	PG D
edelmessing matt	sunshine matt	[.041]	PG E
gold matt	gold matt	[.021]	PG E
platin matt	platinum matt	[.066]	PG E
nerz matt	mink matt	[.096]	PG F
schwarz matt	black matt	[.092]	PG G
weiß matt	white matt	[.052]	PG G
bronze	bronze	[.011]	PG H
gold	gold	[.020]	PG I
roségold	rosegold	[.022]	PG L
roségold matt	rosegold matt	[.023]	PG L

Andere Oberflächen auf Anfrage |
Different colours on request

Auf Anfrage können wir Produkte von Drittanbietern auch gerne passend zu unseren Oberflächen veredeln (vorbehaltlich der Eignungsprüfung) | Third-party products may be plated matching to our colours on request (subject to valuation of suitability)

Waschtisch | Washbasin

ab Seite | from page 308

Bidet | Bidet

ab Seite | from page 308

Wanne | Bath tub

ab Seite | from page 309

Dusche | Shower

ab Seite | from page 310

Accessoires | Accessories







ab Seite | from page 316

PALAZZO CRYSTAL

Maßzeichnungen unter www.joerger.de - Menü SERVICE.
 Technical specifications under www.joerger.de - menu SERVICE.

A chrom chrome	[.000]	E platin matt platinum matt	[.066]
B silbernickel polished nickel	[.035]	F nerz matt mink matt	[.096]
C nerz mink	[.095]	G schwarz-matt black matt	[.092]
C nickel matt satin nickel	[.036]	G weiß-matt white matt	[.052]
D edelmessing sunshine	[.040]	H bronze bronze	[.011]
D platin platinum	[.065]	I gold gold	[.020]
E edelmess.matt sunshine matt	[.041]	L roségold rosegold	[.022]
E gold matt gold matt	[.021]	L roségold matt rosegold matt	[.023]

Waschtisch Batterien | Washbasin mixer

	605.30.300 Waschtisch 3-Loch Batterie 1/2" <ul style="list-style-type: none"> ■ Ausladung 150 mm; Höhe 135 mm ■ Exzenter-Ablaufgarnitur 1 1/4" ■ empfohlen: 2x 649.15.530 - Kupferrohr 300 mm 	Washbasin 3-hole mixer 1/2" <ul style="list-style-type: none"> ■ spout projection 150 mm height 135 mm ■ pop-up waste 1 1/4" ■ recommended: 2x 649.15.530 - copper tube 300 mm 	A	B	C	D	E													
	<table border="0"> <tr> <td>1.495,-</td> <td>1.798,-</td> <td>2.025,-</td> <td>2.277,-</td> <td>2.682,-</td> </tr> <tr> <td>F</td> <td>G</td> <td>H</td> <td>I</td> <td>L</td> </tr> <tr> <td>2.469,-</td> <td>2.026,-</td> <td>2.365,-</td> <td>3.124,-</td> <td>3.731,-</td> </tr> </table>	1.495,-	1.798,-	2.025,-	2.277,-	2.682,-	F	G	H	I	L	2.469,-	2.026,-	2.365,-	3.124,-	3.731,-				
1.495,-	1.798,-	2.025,-	2.277,-	2.682,-																
F	G	H	I	L																
2.469,-	2.026,-	2.365,-	3.124,-	3.731,-																
	605.30.200 Handwaschbecken 3-Loch Batterie 1/2" <ul style="list-style-type: none"> ■ Ausladung 88 mm; Höhe 100 mm ■ Exzenter-Ablaufgarnitur 1 1/4" ■ empfohlen: 2x 649.15.530 - Kupferrohr 300 mm 	Mini washbasin 3-hole mixer 1/2" <ul style="list-style-type: none"> ■ spout projection 88 mm; height 100 mm ■ pop-up waste 1 1/4" ■ recommended: 2x 649.15.530 - copper tube 300 mm 	A	B	C	D	E													
	<table border="0"> <tr> <td>1.428,-</td> <td>1.769,-</td> <td>1.934,-</td> <td>2.176,-</td> <td>2.564,-</td> </tr> <tr> <td>F</td> <td>G</td> <td>H</td> <td>I</td> <td>L</td> </tr> <tr> <td>2.448,-</td> <td>1.999,-</td> <td>2.260,-</td> <td>2.972,-</td> <td>3.712,-</td> </tr> </table>	1.428,-	1.769,-	1.934,-	2.176,-	2.564,-	F	G	H	I	L	2.448,-	1.999,-	2.260,-	2.972,-	3.712,-				
1.428,-	1.769,-	1.934,-	2.176,-	2.564,-																
F	G	H	I	L																
2.448,-	1.999,-	2.260,-	2.972,-	3.712,-																
	605.30.360 Wand-Waschtisch 3-Loch Batterie 1/2", Fertigmontageset <ul style="list-style-type: none"> ■ Wand-Auslauf, Ausladung 215 mm ■ Griff, Hülse, Schubrosette ■ Oberteile 1/2", keramische Scheiben 	Wall washbasin 3-hole mixer 1/2" assembly set <ul style="list-style-type: none"> ■ wall spout, projection 215 mm ■ design handle, socket with adjustable escutcheon ■ cartridges 1/2", with ceramic discs 	A	B	C	D	E													
	<table border="0"> <tr> <td>1.210,-</td> <td>1.428,-</td> <td>1.703,-</td> <td>1.917,-</td> <td>2.257,-</td> </tr> <tr> <td>F</td> <td>G</td> <td>H</td> <td>I</td> <td>L</td> </tr> <tr> <td>2.184,-</td> <td>1.639,-</td> <td>2.173,-</td> <td>2.751,-</td> <td>3.055,-</td> </tr> </table>	1.210,-	1.428,-	1.703,-	1.917,-	2.257,-	F	G	H	I	L	2.184,-	1.639,-	2.173,-	2.751,-	3.055,-				
1.210,-	1.428,-	1.703,-	1.917,-	2.257,-																
F	G	H	I	L																
2.184,-	1.639,-	2.173,-	2.751,-	3.055,-																
Benötigt Required																				
	649.30.380 Wand-Waschtisch 3-Loch Batterie 1/2", Einbaukörper <ul style="list-style-type: none"> ■ 2 Anschlüsse, Stichmaß 204 mm ■ zu Fertigmontageset 605.30.360 	Wall washbasin 3-hole mixer 1/2" concealed body <ul style="list-style-type: none"> ■ 2 connections, center distance 204 mm ■ for assembly set 605.30.360 	A	B	C	D	E													
	<table border="0"> <tr> <td>296,-</td> <td></td> <td></td> <td></td> <td></td> </tr> </table>	296,-																		
296,-																				
	605.10.300 Waschtisch 1-Loch Batterie 1/2" <ul style="list-style-type: none"> ■ Ausladung 115 mm; Höhe 147 mm ■ Keramik-Innenoberteile 1/2" ■ Exzenter-Ablaufgarnitur 1 1/4" ■ 2 Kupferrohre M10x1 x 400 mm 	Washbasin 1-hole mixer 1/2" <ul style="list-style-type: none"> ■ spout projection 115 mm; height 147 mm ■ ceramic internal upper parts 1/2" ■ pop-up waste 1 1/4" ■ 2 copper tubes M10x1 x 400 mm 	A	B	C	D	E													
	<table border="0"> <tr> <td>939,-</td> <td>1.109,-</td> <td>1.317,-</td> <td>1.482,-</td> <td>1.746,-</td> </tr> <tr> <td>F</td> <td>G</td> <td>H</td> <td>I</td> <td>L</td> </tr> <tr> <td>1.659,-</td> <td>1.274,-</td> <td>1.534,-</td> <td>2.118,-</td> <td>2.700,-</td> </tr> </table>	939,-	1.109,-	1.317,-	1.482,-	1.746,-	F	G	H	I	L	1.659,-	1.274,-	1.534,-	2.118,-	2.700,-				
939,-	1.109,-	1.317,-	1.482,-	1.746,-																
F	G	H	I	L																
1.659,-	1.274,-	1.534,-	2.118,-	2.700,-																
	605.10.400 Standventil 1/2" <ul style="list-style-type: none"> ■ Ausladung 95 mm; Höhe 94 mm ■ starrer Auslauf ■ Fettkammer-Innenoberteil 1/2" 	Deck mount tap 1/2" <ul style="list-style-type: none"> ■ spout projection 95 mm; height 94 mm ■ rigid spout ■ cartridge 1/2" 	A	B	C	D	E													
	<table border="0"> <tr> <td>209,-</td> <td>235,-</td> <td>324,-</td> <td>364,-</td> <td>445,-</td> </tr> <tr> <td>F</td> <td>G</td> <td>H</td> <td>I</td> <td>L</td> </tr> <tr> <td>413,-</td> <td>566,-</td> <td>598,-</td> <td>541,-</td> <td>806,-</td> </tr> </table>	209,-	235,-	324,-	364,-	445,-	F	G	H	I	L	413,-	566,-	598,-	541,-	806,-				
209,-	235,-	324,-	364,-	445,-																
F	G	H	I	L																
413,-	566,-	598,-	541,-	806,-																

Bidet Batterien | Bidet mixer





	605.30.100 Bidet 3-Loch Batterie 1/2" <ul style="list-style-type: none"> ■ Ausladung 100 mm; Höhe 100 mm ■ Exzenter-Ablaufgarnitur 1 1/4" ■ empfohlen: 2x 649.15.530 - Kupferrohr 300 mm 	Bidet 3-hole mixer 1/2" <ul style="list-style-type: none"> ■ spout projection 100 mm; height 100 mm ■ pop-up waste 1 1/4" ■ recommended: 2x 649.15.530 - copper tube 300 mm 	A	B	C	D	E													
	<table border="0"> <tr> <td>1.458,-</td> <td>1.700,-</td> <td>1.972,-</td> <td>2.220,-</td> <td>2.614,-</td> </tr> <tr> <td>F</td> <td>G</td> <td>H</td> <td>I</td> <td>L</td> </tr> <tr> <td>2.249,-</td> <td>2.046,-</td> <td>2.304,-</td> <td>3.048,-</td> <td>3.789,-</td> </tr> </table>	1.458,-	1.700,-	1.972,-	2.220,-	2.614,-	F	G	H	I	L	2.249,-	2.046,-	2.304,-	3.048,-	3.789,-				
1.458,-	1.700,-	1.972,-	2.220,-	2.614,-																
F	G	H	I	L																
2.249,-	2.046,-	2.304,-	3.048,-	3.789,-																
	605.10.100 Bidet 1-Loch Batterie 1/2" <ul style="list-style-type: none"> ■ Ausladung 80 mm; Höhe 100 mm ■ Keramik-Innenoberteile 1/2" ■ Exzenter-Ablaufgarnitur 1 1/4" ■ 2 Kupferrohre M10x1 x 400 mm 	Bidet 1-hole mixer 1/2" <ul style="list-style-type: none"> ■ spout projection 80 mm; height 100 mm ■ ceramic internal upper parts 1/2" ■ pop-up waste 1 1/4" ■ 2 copper tubes M10x1 x 400 mm 	A	B	C	D	E													
	<table border="0"> <tr> <td>1.026,-</td> <td>1.213,-</td> <td>1.439,-</td> <td>1.620,-</td> <td>1.907,-</td> </tr> <tr> <td>F</td> <td>G</td> <td>H</td> <td>I</td> <td>L</td> </tr> <tr> <td>1.826,-</td> <td>1.210,-</td> <td>1.675,-</td> <td>2.259,-</td> <td>2.613,-</td> </tr> </table>	1.026,-	1.213,-	1.439,-	1.620,-	1.907,-	F	G	H	I	L	1.826,-	1.210,-	1.675,-	2.259,-	2.613,-				
1.026,-	1.213,-	1.439,-	1.620,-	1.907,-																
F	G	H	I	L																
1.826,-	1.210,-	1.675,-	2.259,-	2.613,-																

PALAZZO CRYSTAL



Maßzeichnungen unter www.joerger.de - Menü SERVICE.
 Technical specifications under www.joerger.de - menu SERVICE.

A chrom chrome	[.000]	E platin matt platinum matt	[.066]
B silbernickel polished nickel	[.035]	F nerz matt milk matt	[.096]
C nerz milk	[.095]	G schwarz-matt black matt	[.092]
C nickel matt satin nickel	[.036]	G weiß-matt white matt	[.052]
D edelmessing sunshine	[.040]	H bronze bronze	[.011]
D platin platinum	[.065]	I gold gold	[.020]
E edelmess.matt sunshine matt	[.041]	L roségold rosegold	[.022]
E gold matt gold matt	[.021]	L roségold matt rosegold matt	[.023]

Zubehör für Waschtisch- und Bidet-Batterien | Supplies for washbasin and bidet mixer

	605.12.100 Eckventil 1/2" <ul style="list-style-type: none"> Ausladung 130 mm Fettkammer-Innenoberteil 1/2" Quetschverschraubung Schubrosette 	Angle valve 1/2" <ul style="list-style-type: none"> projection 130 mm cartridge 1/2" compression joint escutcheon 	A	B	C	D	E	
				338,-	384,-	408,-	412,-	466,-
				F	G	H	I	L
			441,-	430,-	592,-	494,-	836,-	
<hr/>								
	649.15.530 Kupferrohr, 300 mm <ul style="list-style-type: none"> mit Bördel, für Quetschverschraubung 	Copper tube, 300 mm <ul style="list-style-type: none"> with flange, for compression joint 	A	B	C	D	E	
			15,-	38,-	55,-	62,-	74,-	
				F	G	H	I	L
			69,-	75,-	94,-	112,-	169,-	
<hr/>								
Variante Alternative								
	649.15.550 Kupferrohr, 500 mm <ul style="list-style-type: none"> mit Bördel, für Quetschverschraubung 	Copper tube, 500 mm <ul style="list-style-type: none"> with flange, for compression joint 	A	B	C	D	E	
			20,-	58,-	77,-	87,-	102,-	
				F	G	H	I	L
			97,-	77,-	96,-	134,-	219,-	
<hr/>								
	649.15.340 Waschtisch-Tassensiphon 1 1/4" <ul style="list-style-type: none"> schwere Ausführung Rosette Abgangsrohr ø 32 mm Tauchrohrlänge 165 mm 	Washbasin cupped siphon trap 1 1/4" <ul style="list-style-type: none"> heavy brass escutcheon outlet tube ø 32 mm dip pipe 165 mm 	A	B	C	D	E	
			195,-	296,-	368,-	429,-	568,-	
				F	G	H	I	L
			498,-	378,-	539,-	686,-	832,-	
<hr/>								
	649.15.330 Bidet-Tassensiphon 1 1/4" <ul style="list-style-type: none"> Rosette Abgangsrohr ø 32 mm 	Bidet cupped siphon trap 1 1/4" <ul style="list-style-type: none"> escutcheon outlet tube ø 32 mm 	A	B	C	D	E	
			98,-	166,-	276,-	332,-	472,-	
				F	G	H	I	L
			399,-	364,-	508,-	648,-	796,-	

Badewanne, Stand-Batterien | Bath tub mixer sets, deck mount

	605.40.100 4-Loch Wannenfüll- und Brausebatterie 1/2" für Standmontage <ul style="list-style-type: none"> Ausladung 230 mm; Höhe 176 mm 2 Seitenrandventile mit keramischen Oberteilen 1/2" Metall-Brauseschlauch 2000 mm Metall-Handbrause mit Anti-Kalk-System und Rückflussverhinderer 	Tub/shower mixer set 1/2" deck mount <ul style="list-style-type: none"> spout projection 230 mm; height 176 mm 2 side valves, ceramic internal upper parts 1/2" metal shower hose 2000 mm metal hand shower with anticalc. system and backflow preventer 	A	B	C	D	E	
			2.523,-	2.755,-	3.414,-	3.843,-	4.343,-	
				F	G	H	I	L
			4.118,-	1.985,-	3.989,-	4.889,-	5.590,-	
<hr/>								
Empfohlen Recommended								
	649.40.160 Montageplatte, komplett <ul style="list-style-type: none"> für 4-Loch Armaturen Druckschläuche 1/2" x 1/2" x 600 mm empfohlen: Schlauchkastensystem siehe Kapitel "Serienübergreifendes" 	Assembly plate, complete <ul style="list-style-type: none"> for deck mounted tub/shower mixer pressure hoses 1/2" x 1/2" x 600 mm recommended: system with hose box see chapter "universal products" 	A					
			308,-					
<hr/>								
	605.40.150 4-Loch Wannenrandkombination 1/2" <ul style="list-style-type: none"> für Ab- und Überlaufgarnitur mit Wanneneinlauf, ohne Rohrunterbrecher Seitenrandventile, 2-Wege Umstellung Metall-Brauseschlauch 2000 mm Metall-Handbrause mit Anti-Kalk-System und Rückflussverhinderer empfohlen: 649.40.160 - Montageplatte 	tub/shower combination 1/2" <ul style="list-style-type: none"> for waste and overflow set with bath tub filler spout, without pipe interrupter side valves, 2-position diverter metal shower hose 2000 mm metal hand shower with anticalc. system and backflow preventer recommended: 649.40.160 - assembly plate 	A	B	C	D	E	
			1.738,-	1.869,-	1.978,-	2.225,-	2.583,-	
				F	G	H	I	L
			2.265,-	2.157,-	2.684,-	2.918,-	3.608,-	

PALAZZO CRYSTAL

Maßzeichnungen unter www.joerger.de - Menü SERVICE.
 Technical specifications under www.joerger.de - menu SERVICE.

A chrom chrome	[.000]	E platin matt platinum matt	[.066]
B silbernickel polished nickel	[.035]	F nerz matt milk matt	[.096]
C nerz milk	[.095]	G schwarz-matt black matt	[.092]
C nickel matt satin nickel	[.036]	G weiß-matt white matt	[.052]
D edelmessing sunshine	[.040]	H bronze bronze	[.011]
D platin platinum	[.065]	I gold gold	[.020]
E edelmess.matt sunshine matt	[.041]	L roségold rosegold	[.022]
E gold matt gold matt	[.021]	L roségold matt rosegold matt	[.023]

605.20.410 – Aufputz Set mit Steigrohr | Exposed set with shower system



649.13.920 Regenbrause ½", ø 200 mm ■ Ausführung ganz in Metall ■ mit Kugelgelenk ■ Anti-Kalk-System	Rain shower head ½", ø 200 mm ■ full metal body ■ with ball joint ■ with anticalcareous system	A	B	C	D	E
		260,-	619,-	824,-	895,-	1.268,-
		F	G	H	I	L
		1.085,-	821,-	1.098,-	1.389,-	2.189,-
649.20.281 Steigrohr, Umstellung, Wandarm ■ zum Anschluß an die Brausebatterie ■ Ausladung 360 - 380 mm ■ in der Neigung und Höhe verstellbare Brausehalterung	Supply pipe, diverter, wall bracket ■ to connect the exposed shower mixer ■ projection 360 - 380 mm ■ fitting for handshower adjustable in height and inclination	A	B	C	D	E
		568,-	925,-	1.161,-	1.235,-	1.710,-
		F	G	H	I	L
		1.349,-	1.314,-	1.649,-	1.957,-	2.796,-
605.13.700 Brausegarnitur ■ Metall-Handbrause mit Anti-Kalk-System und Rückflussverhinderer ■ Brauseschlauch 1500 mm, beidseitig mit drehbarem Konus	Shower combination ■ metal hand shower with anticalc. system and backflow preventer ■ metal shower hose 1500 mm, both sides with turning cone	A	B	C	D	E
		302,-	482,-	575,-	620,-	842,-
		F	G	H	I	L
		747,-	694,-	982,-	942,-	1.466,-
605.20.210 Aufputz-Brausebatterie ½" ■ für Steigrohr ■ Brauseabgang ¾"	Exposed shower mixer ½" ■ for supply pipe ■ discharge ¾"	A	B	C	D	E
		475,-	609,-	824,-	844,-	996,-
		F	G	H	I	L
		927,-	1.117,-	1.364,-	1.087,-	2.392,-

605.20.460 – Aufputz Set mit Steigrohr | Exposed set with shower system







649.13.920 Regenbrause ½", ø 200 mm ■ Ausführung ganz in Metall ■ mit Kugelgelenk ■ Anti-Kalk-System	Rain shower head ½", ø 200 mm ■ full metal body ■ with ball joint ■ with anticalcareous system	A	B	C	D	E
		260,-	619,-	824,-	895,-	1.268,-
		F	G	H	I	L
		1.085,-	821,-	1.098,-	1.389,-	2.189,-
649.20.281 Steigrohr, Umstellung, Wandarm ■ zum Anschluß an die Brausebatterie ■ Ausladung 360 - 380 mm ■ in der Neigung und Höhe verstellbare Brausehalterung	Supply pipe, diverter, wall bracket ■ to connect the exposed shower mixer ■ projection 360 - 380 mm ■ fitting for handshower adjustable in height and inclination	A	B	C	D	E
		568,-	925,-	1.161,-	1.235,-	1.710,-
		F	G	H	I	L
		1.349,-	1.314,-	1.649,-	1.957,-	2.796,-
605.13.700 Brausegarnitur ■ Metall-Handbrause mit Anti-Kalk-System und Rückflussverhinderer ■ Brauseschlauch 1500 mm, beidseitig mit drehbarem Konus	Shower combination ■ metal hand shower with anticalc. system and backflow preventer ■ metal shower hose 1500 mm, both sides with turning cone	A	B	C	D	E
		302,-	482,-	575,-	620,-	842,-
		F	G	H	I	L
		747,-	694,-	982,-	942,-	1.466,-
605.20.260 Aufputz-Brauser thermostat ½" ■ für Steigrohr ■ Brauseabgang ¾"	Exposed shower thermostat ½" ■ for supply pipe ■ discharge ¾"	A	B	C	D	E
		1.399,-	1.704,-	1.883,-	2.015,-	2.707,-
		F	G	H	I	L
		2.427,-	1.982,-	2.432,-	3.029,-	3.558,-

PALAZZO CRYSTAL



Maßzeichnungen unter www.joerger.de - Menü SERVICE.
 Technical specifications under www.joerger.de - menu SERVICE.

A chrom chrome	[.000]	E platin matt platinum matt	[.066]
B silbernickel polished nickel	[.035]	F nerz matt milk matt	[.096]
C nerz milk	[.095]	G schwarz-matt black matt	[.092]
C nickel matt satin nickel	[.036]	G weiß-matt white matt	[.052]
D edelmessing sunshine	[.040]	H bronze bronze	[.011]
D platin platinum	[.065]	I gold gold	[.020]
E edelmess.matt sunshine matt	[.041]	L roségold rosegold	[.022]
E gold matt gold matt	[.021]	L roségold matt rosegold matt	[.023]



Unterputz-Thermostate 1/2" | Wall thermostats, concealed 1/2"

	605.40.380 Unterputz-Thermostat 1/2" mit Mengenregulierung, Fertigmontageset <ul style="list-style-type: none"> manuelle, keramische Umstellung Wanne/Brause, druckunabhängig mit Sicherheitseinrichtung Durchflussrate 20,4 l/min bei 3 bar 	Concealed wall thermostat 1/2" with flow control, assembly set <ul style="list-style-type: none"> manual, ceramic diverter tub/shower for pressure-independent function with safety device flow rate 20,4 l/min at 3 bar 	A	B	C	D	E
			1.165,-	1.228,-	1.515,-	1.555,-	1.854,-
	605.40.360 Unterputz-Thermostat 1/2" mit Mengenregulierung, Fertigmontageset <ul style="list-style-type: none"> ohne Umstellung mit integrierter keramischer Mengenregulierung Durchflussrate 20,4 l/min bei 3 bar 	Concealed wall thermostat 1/2" with flow control, assembly set <ul style="list-style-type: none"> without diverter with integrated ceramic cartridge for volume control flow rate 20,4 l/min at 3 bar 	A	B	C	D	E
			1.078,-	1.208,-	1.480,-	1.519,-	1.818,-
	637.40.460 Unterputz-Thermostat 1/2" ohne Mengenregulierung, Fertigmontageset <ul style="list-style-type: none"> Funktionseinheit ohne Umstellung und ohne Absperrung Durchflussrate 25,8 l/min bei 3 bar 	Concealed wall thermostat 1/2" without flow control, assembly set <ul style="list-style-type: none"> Functional unit without diverter and without shut-off flow rate 25,8 l/min at 3 bar 	A	B	C	D	E
			884,-	1.038,-	1.220,-	1.279,-	1.539,-
Variante Alternative			F	G	H	I	L
Benötigt Required			F	G	H	I	L
	649.40.360 Unterputz-Einbaubox 1/2" zu Fertigmontageset 605.40.360, 605.40.380 und 637.40.460 für Nass- und Trockenbau geeignet	Concealed wall box 1/2" for assembly set 605.40.360, 605.40.380 und 637.40.460 for wetwall and drywall construction	A				
			168,-				

Unterputz-Thermostat 3/4" mit hohem Durchfluß | Wall thermostat, concealed 3/4" with high flow

	605.40.560 Unterputz-Thermostat 3/4" ohne Mengenregulierung, Fertigmontageset <ul style="list-style-type: none"> serienbezogener Temperiergriff Sicherheitssperre bei 38° C 	Concealed wall thermostat 3/4" without flow control, assembly set <ul style="list-style-type: none"> design handle for temp. control locking device at 38° C 	A	B	C	D	E
			675,-	729,-	1.138,-	1.182,-	1.492,-
	649.40.555 Unterputz-Einbaukörper 3/4" zu Fertigmontageset 605.40.555 Kartusche mit Schmutzfangsieben für Nass- und Trockenbau geeignet Durchflussrate 64,2 l/min bei 3 bar ohne Absperrung	Concealed thermostat body 3/4" for assembly set 605.40.555 cartridge with filter screens for wetwall and drywall construction flow rate 64,2 l/min at 3 bar without shut-off	A				
			1.636,-				

Unterputz-Thermostat 3/4" | Wall thermostat, concealed 3/4"











	605.40.520 Unterputz-Thermostat 3/4" ohne Mengenregulierung, Fertigmontageset <ul style="list-style-type: none"> serienbezogener Temperiergriff Sicherheitssperre bei 38° C 	Concealed wall thermostat 3/4" without flow control, assembly set <ul style="list-style-type: none"> design handle for temp. control locking device at 38° C 	A	B	C	D	E
			675,-	729,-	1.138,-	1.182,-	1.492,-
	649.40.520 Unterputz-Einbaukörper 3/4" zu Fertigmontageset 605.40.520 Kartusche mit Schmutzfangsieben für Nass- und Trockenbau geeignet Durchflussrate 41 l/min bei 3 bar ohne Absperrung	Concealed thermostat body 3/4" for assembly set 605.40.520 cartridge with filter screens for wetwall and drywall construction flow rate 41 l/min at 3 bar without shut-off	A				
			498,-				

PALAZZO CRYSTAL

Maßzeichnungen unter www.joerger.de - Menü SERVICE.
 Technical specifications under www.joerger.de - menu SERVICE.

A chrom chrome	[.000]	E platin matt platinum matt	[.066]
B silbernickel polished nickel	[.035]	F nerz matt milk matt	[.096]
C nerz milk	[.095]	G schwarz-matt black matt	[.092]
C nickel matt satin nickel	[.036]	G weiß-matt white matt	[.052]
D edelmessing sunshine	[.040]	H bronze bronze	[.011]
D platin platinum	[.065]	I gold gold	[.020]
E edelmess.matt sunshine matt	[.041]	L roségold rosegold	[.022]
E gold matt gold matt	[.021]	L roségold matt rosegold matt	[.023]

Unterputz-Thermostat/Ventil-Modul | Concealed thermostatic/wall-valve modul







			A	B	C	D	E
	605.60.432 Unterputz-Ventil-Modul Fertigmontageset	Concealed wall-valve-modul assembly set	314,-	377,-	442,-	497,-	580,-
	<ul style="list-style-type: none"> Griff Rosette 	<ul style="list-style-type: none"> design handle escutcheon 					
	Benötigt Required						
	649.20.610 Unterputz-Ventil-Modul, 1-fach	Concealed wall-valve-modul, single	229,-				
	<ul style="list-style-type: none"> 1x Spindelventil 3/4", rechtsschließend mit keram. Scheiben 2 Abgänge 1/2", je 1x rechts/links möglich, gleichzeitig benutzbar 	<ul style="list-style-type: none"> 1x spindle valve 3/4", clockwise closure with ceramic discs 2 outlets 1/2", each 1x right/left possible, simultaneously usable 					
	Benötigt Required						
	649.20.620 Unterputz-Ventil-Modul, 2-fach	Concealed wall-valve-modul, double	458,-				
	<ul style="list-style-type: none"> 2x Spindelventil 3/4", rechtsschließend mit keram. Scheiben 4 Abgänge 1/2", je 2x rechts/links möglich, gleichzeitig benutzbar im Verbund maßgenaue Montage erweiterbar mit 649.20.610 	<ul style="list-style-type: none"> 2x spindle valve 3/4", clockwise closure with ceramic discs 4 outlets 1/2", each 2x right/left possible, simultaneously usable precise assembly due to composite expandable with 649.20.610 					
	Benötigt Required						
	649.20.630 Unterputz-Ventil-Modul, 3-fach	Concealed wall-valve-modul, triple	686,-				
	<ul style="list-style-type: none"> 3x Spindelventil 3/4", rechtsschließend mit keram. Scheiben 6 Abgänge 1/2", je 3x rechts/links möglich, gleichzeitig benutzbar im Verbund maßgenauen Montage erweiterbar mit 649.20.610 	<ul style="list-style-type: none"> 3x spindle valve 3/4", clockwise closure with ceramic discs 6 outlets 1/2", each 3x right/left possible, simultaneously usable precise assembly due to composite expandable with 649.20.610 					
	Benötigt Required						
	637.40.460 Unterputz-Thermostat 1/2" ohne Mengenregulierung, Fertigmontageset	Concealed wall thermostat 1/2" without flow control, assembly set	884,-	1.038,-	1.220,-	1.279,-	1.539,-
	<ul style="list-style-type: none"> Funktionseinheit ohne Umstellung und ohne Absperrung Durchflussrate 25,8 l/min bei 3 bar 	<ul style="list-style-type: none"> Functional unit without diverter and without shut-off flow rate 25,8 l/min at 3 bar 					
	Benötigt Required						
	649.20.612 Anschlußadapter 1/2"	Connection adapter 1/2"	122,-				
	<ul style="list-style-type: none"> Anschlußadapter, Abschlußstopfen passend zu Einbaubox 649.40.360 	<ul style="list-style-type: none"> connection adapter, end plug matching to wall box 649.40.360 					
	Benötigt Required						
	649.40.360 Unterputz-Einbaubox 1/2"	Concealed wall box 1/2"	168,-				
	<ul style="list-style-type: none"> zu Fertigmontageset 637.40.460 für Nass- und Trockenbau geeignet 	<ul style="list-style-type: none"> for assembly set 637.40.460 for wetwall and drywall construction 					
	Benötigt Required						
	605.40.560 Unterputz-Thermostat 3/4" ohne Mengenregulierung, Fertigmontageset	Concealed wall thermostat 3/4" without flow control, assembly set	675,-	729,-	1.138,-	1.182,-	1.492,-
	<ul style="list-style-type: none"> serienbezogener Temperiergriff Sicherheitsperre bei 38° C 	<ul style="list-style-type: none"> design handle for temp. control locking device at 38° C 					
	Benötigt Required						
	649.20.634 Anschlußadapter 3/4"	Connection adapter 3/4"	146,-				
	<ul style="list-style-type: none"> Anschlußadapter, Abschlußstopfen passend zu Einbaukörper 649.40.555 	<ul style="list-style-type: none"> connection adapter, end plug matching to wall body 649.40.555 					
	Benötigt Required						
	649.40.555 Unterputz-Einbaukörper 3/4"	Concealed thermostat body 3/4"	1.636,-				
	<ul style="list-style-type: none"> zu Fertigmontageset 605.40.555 Kartusche mit Schmutzfangsieben für Nass- und Trockenbau geeignet Durchflussrate 64,2 l/min bei 3 bar ohne Absperrung 	<ul style="list-style-type: none"> for assembly set 605.40.555 cartridge with filter screens for wetwall and drywall construction flow rate 64,2 l/min at 3 bar without shut-off 					
	Benötigt Required						

PALAZZO CRYSTAL





Maßzeichnungen unter www.joerger.de - Menü SERVICE.
 Technical specifications under www.joerger.de - menu SERVICE.

A chrom chrome	[.000]	E platin matt platinum matt	[.066]
B silbernickel polished nickel	[.035]	F nerz matt mink matt	[.096]
C nerz mink	[.095]	G schwarz-matt black matt	[.092]
C nickel matt satin nickel	[.036]	G weiß-matt white matt	[.052]
D edelmessing sunshine	[.040]	H bronze bronze	[.011]
D platin platinum	[.065]	I gold gold	[.020]
E edelmess.matt sunshine matt	[.041]	L roségold rosegold	[.022]
E gold matt gold matt	[.021]	L roségold matt rosegold matt	[.023]

Unterputz-Umstellung und Ventile | Diverter and valves concealed

	605.40.650 Unterputz 3-Wege Umstellung 1/2" Fertigmontageset ■ Griff ■ Hülse, Schubrosette	Concealed 3-position diverter 1/2" assembly set ■ design handle ■ socket with adjustable escutcheon	A	B	C	D	E	
			315,-	377,-	442,-	497,-	580,-	
			F	G	H	I	L	
				539,-	462,-	564,-	687,-	745,-
Benötigt Required								
	649.40.600 Unterputz 3-Wege Umstellung 1/2" Einbaukörper ■ zu Fertigmontageset 605.40.650	Concealed 3-position diverter 1/2" diverter body ■ for assembly set 605.40.650	A					
			236,-					
	605.50.234 Unterputz-Ventil Fertigmontageset ■ Griff ■ Hülse, Schubrosette	Concealed wall valve assembly set ■ design handle ■ socket with adjustable escutcheon	A	B	C	D	E	
			369,-	382,-	407,-	424,-	499,-	
			F	G	H	I	L	
				460,-	454,-	538,-	591,-	737,-
Benötigt Required								
	649.20.340 Unterputz-Ventil 1/2", Einbaukörper ■ rechtsschließend, ker. Scheiben	Concealed wall valve 1/2", body ■ clockwise closure, ceramic discs	A					
			62,-					
	649.20.345 Unterputz-Ventil 1/2", Einbaukörper ■ linksschließend, ker. Scheiben	Concealed wall valve 1/2", body ■ counter-clockwise closure, cer. discs						
	649.20.440 Unterputz-Ventil 3/4", Einbaukörper ■ rechtsschließend, ker. Scheiben	Concealed wall valve 3/4", body ■ clockwise closure, ceramic discs	A					
			106,-					
	649.20.445 Unterputz-Ventil 3/4", Einbaukörper ■ linksschließend, ker. Scheiben	Concealed wall valve 3/4", body ■ counter-clockwise closure, cer. discs						

Brausen | Showers

	605.13.310 Duschgarnitur, komplett ■ Wandrohr 780 mm, mit Schieber ■ Metall-Handbrause mit Anti-Kalk-System und Rückflussverhinderer ■ Metall-Brauseschlauch 1750 mm, beidseitig mit drehbarem Konus	Shower bar set, complete ■ wall bar 780 mm, with slider ■ metal hand shower with anticalc. system and backflow preventer ■ metal shower hose 1750 mm, both sides with turning cone	A	B	C	D	E	
			1.654,-	1.897,-	2.018,-	2.096,-	2.572,-	
			F	G	H	I	L	
				2.361,-	2.057,-	2.484,-	2.794,-	3.809,-
	605.13.350 Duschstange, lose ■ Wandrohr 780 mm, mit Schieber	Shower bar, separate ■ wall bar 780 mm, with slider	A	B	C	D	E	
			807,-	1.251,-	1.432,-	1.572,-	1.942,-	
			F	G	H	I	L	
				1.796,-	1.642,-	1.998,-	2.276,-	2.926,-
	605.13.200 Schlauchbrausegarnitur ■ Wandanschlußbogen 1/2" ■ Wand-Brausehalter ■ Metall-Handbrause mit Anti-Kalk-System und Rückflussverhinderer ■ Metall-Brauseschlauch 1500 mm, beidseitig mit drehbarem Konus	Shower combination ■ Wall elbow connection 1/2" ■ Wall fitting for hand shower ■ metal hand shower with anticalc. system and backflow preventer ■ flexible metal shower hose 1500 mm, both sides with turning cone	A	B	C	D	E	
			535,-	732,-	921,-	1.037,-	1.221,-	
			F	G	H	I	L	
				1.043,-	908,-	1.215,-	1.363,-	1.747,-
	601.13.150 Wandanschlußbogen 1/2", ohne Haken ■ Brauseabgang 1/2" ■ mit Rückflussverhinderer, Rosette	Wall elbow connection 1/2", without cradle ■ discharge 1/2" ■ with backflow preventer, escutcheon	A	B	C	D	E	
			99,-	118,-	129,-	134,-	158,-	
			F	G	H	I	L	
				147,-	158,-	198,-	183,-	313,-

PALAZZO CRYSTAL

Maßzeichnungen unter www.joerger.de - Menü SERVICE.
 Technical specifications under www.joerger.de - menu SERVICE.

A chrom chrome	[.000]	E platin matt platinum matt	[.066]
B silbernickel polished nickel	[.035]	F nerz matt milk matt	[.096]
C nerz milk	[.095]	G schwarz-matt black matt	[.092]
C nickel matt satin nickel	[.036]	G weiß-matt white matt	[.052]
D edelmessing sunshine	[.040]	H bronze bronze	[.011]
D platin platinum	[.065]	I gold gold	[.020]
E edelmess.matt sunshine matt	[.041]	L roségold rosegold	[.022]
E gold matt gold matt	[.021]	L roségold matt rosegold matt	[.023]



649.13.210 Wand-Brausehalter

Wall fitting for hand shower

A	B	C	D	E
178,-	214,-	266,-	287,-	337,-
F	G	H	I	L
299,-	256,-	325,-	374,-	459,-



601.13.237 Hygienebrausegarnitur
 ■ Wandbrausehalter und -anschlußbogen 1/2", Schubrosette
 ■ Hygienebrause, klassisch (649.13.338), komplett aus Metall
 ■ einstrahlig, Bedienung über Druckhebel
 ■ Metall-Brauseschlauch 1250 mm

Ablution spray combination
 ■ wall fitting and elbow connection 1/2"
 ■ spray handshower, classical (649.13.338), completely metal
 ■ one jet, push-lever operation
 ■ flexible metal shower hose 1250 mm

A	B	C	D	E
301,-	373,-	612,-	641,-	859,-
F	G	H	I	L
737,-	671,-	998,-	1.101,-	1.529,-



605.20.237 1-Hand Batterie 1/2" für Hygienebrause, Fertigmontageset
 ■ Rosette, Griff
 ■ mit Kristallgriff

Concealed single lever 1/2" for ablution spray, assembly set
 ■ escutcheon, handle
 ■ with crystal handle

A	B	C	D	E
319,-	434,-	529,-	595,-	699,-
F	G	H	I	L
648,-	556,-	632,-	775,-	839,-

Benötigt | Required



649.20.237 Unterputz 1-Hand Batterie 1/2", Einbaukörper
 ■ Kartusche mit keramischen Scheiben
 ■ zu Fertigmontageset 605.20.237

Single lever mixer 1/2", concealed body
 ■ cartridge with ceramic discs
 ■ for assembly set 605.20.237

A	B	C	D	E
125,-	169,-	208,-	229,-	268,-
F	G	H	I	L
249,-	224,-	258,-	329,-	396,-



649.13.615 Stachelkopfbrause 1/2"
 ■ ø 230 mm, 75 Düsen
 ■ Ausführung ganz in Metall
 ■ Anti-Kalk-System
 ■ Brausekopf schwenkbar
 ■ ohne Wandarm
 ■ weitere, zur Serie passende Kopfbrausen siehe Kapitel "Brausen"

Body spray shower head 1/2"
 ■ ø 230 mm, 75 jets
 ■ full metal body
 ■ anticalcareous system
 ■ swivel shower head
 ■ without wall bracket
 ■ for further shower heads matching this collection see chapter "showers"

A	B	C	D	E
969,-	1.232,-	1.359,-	1.416,-	1.659,-
F	G	H	I	L
1.496,-	1.399,-	1.718,-	2.262,-	2.739,-

Empfohlen | Recommended



649.13.625 Wandarm 1/2"
 ■ Ausladung 162 mm
 ■ weitere, zur Serie passende Wandarme siehe Kapitel "Brausen"

Wall bracket 1/2"
 ■ projection 162 mm
 ■ for further wall brackets matching this collection see chapter "showers"

A	B	C	D	E
126,-	145,-	171,-	189,-	250,-
F	G	H	I	L
229,-	192,-	296,-	286,-	499,-



649.13.519 Seitenbrause 1/2"
 ■ Rosette ø 130 mm, Wandmontage
 ■ Brausekopf schwenkbar, 20°
 ■ Anti-Kalk-System
 ■ Ausführung Kunststoff
 ■ weitere, zur Serie passende Seitenbrausen siehe Kapitel "Brausen"

Body spray side shower 1/2"
 ■ escutcheon ø 130 mm, wall assembly
 ■ swivel shower head, 20°
 ■ anticalcareous system
 ■ plastic
 ■ for further side showers matching this collection see chapter "showers"













A	B	C	D	E
167,-	326,-	385,-	399,-	542,-
F	G	H	I	L
496,-	376,-	472,-	634,-	949,-

PALAZZO CRYSTAL



Maßzeichnungen unter www.joerger.de - Menü SERVICE.
 Technical specifications under www.joerger.de - menu SERVICE.

A chrom chrome	[.000]	E platin matt platinum matt	[.066]
B silbernickel polished nickel	[.035]	F nerz matt mink matt	[.096]
C nerz mink	[.095]	G schwarz-matt black matt	[.092]
C nickel matt satin nickel	[.036]	G weiß-matt white matt	[.052]
D edelmessing sunshine	[.040]	H bronze bronze	[.011]
D platin platinum	[.065]	I gold gold	[.020]
E edelmess.matt sunshine matt	[.041]	L roségold rosegold	[.022]
E gold matt gold matt	[.021]	L roségold matt rosegold matt	[.023]

Accessoires für Handtücher | Accessories for towels

	605.00.002 Handtuchhalter, doppelt ■ Rohre schwenkbar, ca. 430 mm	Double towel bar ■ swivelling bars, approx. 430 mm	A	B	C	D	E
			485,-	638,-	654,-	674,-	812,-
	605.00.012 Handtuchhalter, doppelt ■ verkürzt, ca. 300 mm	Double towle bar ■ shortened, approx. 300 mm	F	G	H	I	L
			750,-	699,-	799,-	984,-	1.286,-
	605.00.047 Handtuchring ■ ø ca. 190 mm ■ geschlossene Ausführung	Towel ring ■ ø approx. 190 mm ■ closed version	A	B	C	D	E
			515,-	626,-	638,-	656,-	728,-
			F	G	H	I	L
			685,-	657,-	712,-	775,-	1.068,-
	605.00.022 Handtuchhaken	Robe hanger	A	B	C	D	E
			324,-	415,-	434,-	456,-	492,-
			F	G	H	I	L
			471,-	504,-	612,-	598,-	704,-
	605.00.040 Badetuchhalter ■ ca. 800 mm	Bath towel bar ■ approx. 762 mm (30")	A	B	C	D	E
			994,-	1.282,-	1.326,-	1.436,-	1.589,-
			F	G	H	I	L
			1.484,-	1.170,-	1.384,-	1.699,-	2.200,-
	605.00.031 Wannengriff ■ ca. 400 mm	Tub handle ■ approx. 400 mm (15 ³ / ₄)	A	B	C	D	E
			916,-	1.092,-	1.124,-	1.169,-	1.334,-
			F	G	H	I	L
			1.257,-	1.077,-	1.150,-	1.415,-	1.606,-
	605.00.104 Gästehandtuchkorb, eckig ■ mit Ablage ■ Korbgröße 260 x 150 x 190 mm	Guest towel basket, angular ■ with shelf ■ basket size 260 x 150 x 190 mm	A	B	C	D	E
			428,-	667,-	704,-	734,-	908,-
			F	G	H	I	L
			831,-	707,-	1.112,-	989,-	2.018,-

Accessoires für Waschplatz | Accessories for washstands

	605.00.007 Seifenhalter, komplett ■ Seifenschale aus Kristallglas	Soap dish holder, complete ■ crystal glass dish	A	B	C	D	E
			539,-	568,-	588,-	625,-	734,-
			F	G	H	I	L
			671,-	549,-	634,-	890,-	983,-
	701.00.307 Seifenschale, lose	Glass dish, separate	A				
			89,-				

PALAZZO CRYSTAL

Maßzeichnungen unter www.joerger.de - Menü SERVICE.
 Technical specifications under www.joerger.de - menu SERVICE.

A chrom chrome	[.000]	E platin matt platinum matt	[.066]
B silbernickel polished nickel	[.035]	F nerz matt milk matt	[.096]
C nerz milk	[.095]	G schwarz-matt black matt	[.092]
C nickel matt satin nickel	[.036]	G weiß-matt white matt	[.052]
D edelmessing sunshine	[.040]	H bronze bronze	[.011]
D platin platinum	[.065]	I gold gold	[.020]
E edelmess.matt sunshine matt	[.041]	L roségold rosegold	[.022]
E gold matt gold matt	[.021]	L roségold matt rosegold matt	[.023]

	605.00.105 Schwammkorb ■ rechteckig, 260 x 130 mm	Sponge basket ■ rectangular, 260 x 130 mm	A	B	C	D	E
			322,-	652,-	692,-	722,-	896,-
			F	G	H	I	L
			819,-	695,-	872,-	978,-	1.379,-

	605.00.106 Eckschwammkorb ■ 195 x 195 mm	Corner sponge basket ■ 195 x 195 mm	A	B	C	D	E
			351,-	619,-	638,-	662,-	805,-
			F	G	H	I	L
			739,-	691,-	795,-	869,-	1.287,-

	605.00.036 Glashalter, komplett ■ Glas aus Kristallglas	Tumbler holder, complete ■ crystal glass tumbler	A	B	C	D	E
			574,-	608,-	642,-	668,-	794,-
			F	G	H	I	L
			727,-	606,-	676,-	963,-	994,-

	700.00.336 Mundglas, lose	Glass tumbler, separate	A				
			96,-				

	605.00.006 Lotionspender, komplett	Soap dispenser, complete	A	B	C	D	E
			618,-	688,-	718,-	745,-	822,-
			F	G	H	I	L
			776,-	727,-	776,-	908,-	1.104,-

	713.00.306 Lotionspenderglas, lose ■ seidenmatt, ohne Pumpe	Soap dispenser glass, separate ■ frosted, without pump	A				
			78,-				

	605.00.009 Ablage, 600 mm ■ Glasplatte aus Kristallglas	Shelf holder with glass, 600 mm ■ crystal glass shelf	A	B	C	D	E
			1.075,-	1.106,-	1.154,-	1.189,-	1.289,-
			F	G	H	I	L
			1.228,-	1.096,-	1.139,-	1.354,-	1.658,-

Accessoires für WC-Bereich | Accessories for w.c. area

	605.00.014 Papierhalter ■ mit Deckel	Toilet paper roll holder ■ with lid	A	B	C	D	E
			548,-	622,-	707,-	796,-	976,-
			F	G	H	I	L
			894,-	655,-	844,-	1.195,-	1.295,-

	605.00.015 Reserve-Papierhalter	Spare toilet paper roll holder	A	B	C	D	E
			486,-	534,-	568,-	580,-	663,-
			F	G	H	I	L
			619,-	553,-	632,-	805,-	876,-



PALAZZO CRYSTAL

Maßzeichnungen unter www.joerger.de - Menü SERVICE.
 Technical specifications under www.joerger.de - menu SERVICE.

A chrom chrome	[.000]	E platin matt platinum matt	[.066]
B silbernickel polished nickel	[.035]	F nerz matt milk matt	[.096]
C nerz milk	[.095]	G schwarz-matt black matt	[.092]
C nickel matt satin nickel	[.036]	G weiß-matt white matt	[.052]
D edelmessing sunshine	[.040]	H bronze bronze	[.011]
D platin platinum	[.065]	I gold gold	[.020]
E edelmess.matt sunshine matt	[.041]	L roségold rosegold	[.022]
E gold matt gold matt	[.021]	L roségold matt rosegold matt	[.023]

	605.00.000 Klosettbürstengarnitur, komplett ■ Glas aus Kristallglas, seidenmatt	Toilet brush holder set, complete ■ crystal glass, frosted	A	B	C	D	E
			729,-	799,-	895,-	914,-	1.072,-
			F	G	H	I	L
			999,-	845,-	1.038,-	1.148,-	1.369,-
	799.00.300 Bürstenglas, seidenmatt, lose	Brush glass, frosted, separate	A				
			48,-				
	651.00.053 Bürstenstange komplett, lose	Brush rod with brush, separate	A	B	C	D	E
			121,-	148,-	176,-	197,-	232,-
			F	G	H	I	L
			215,-	167,-	214,-	280,-	369,-
	799.00.224 Bürstenkopf, lose	Brush, separate	A				
			19,-				

Leuchten und Spiegel | Lamps and mirrors

	605.00.061 Wandleuchte, komplett ■ mit Leuchtmittel, 40 W	Wall lamp, complete ■ light bulb included, 40 W	A	B	C	D	E
			572,-	634,-	801,-	902,-	1.063,-
			F	G	H	I	L
			996,-	982,-	961,-	1.197,-	1.744,-
	705.00.361 Leuchtenglas, lose ■ Leuchtenglas klar	Glass, separate ■ glass clear	A				
			196,-				
	649.00.414 Kosmetikspiegel, beleuchtet ■ schwenk- und ausziehbar ■ 3-fache Vergrößerung ■ Direktanschluss ■ Spiegeldurchmesser 185 mm ■ Rahmendurchmesser 250 mm ■ Kalt-, Warm- und Taglicht durch Piezzo-Schalter umschaltbar	Cosmetic mirror, incl. lighting ■ swivelling and extendable ■ magnification 3:1 ■ direct connection ■ mirror diameter 185 mm ■ frame diameter 250 mm ■ cold, warm and day light switchable by Piezzo switch	A	B	C	D	E
			556,-	988,-	1.214,-	1.418,-	1.828,-
			F	G	H	I	L
			1.684,-	1.214,-	1.549,-	2.138,-	2.998,-



Oberflächen | colours

Folgende Oberflächen sind bei dieser Serie möglich |
The following colours are possible with this collection

chrom	chrome	[.000] PG A
silbernickel	polished nickel	[.035] PG B
nerz	mink	[.095] PG C
nickel matt	satin nickel	[.036] PG C
edelmessing	sunshine	[.040] PG D
platin	platinum	[.065] PG D
edelmessing matt	sunshine matt	[.041] PG E
gold matt	gold matt	[.021] PG E
platin matt	platinum matt	[.066] PG E
schwarz matt	black matt	[.092] PG G
weiß matt	white matt	[.052] PG G
bronze	bronze	[.011] PG H
gold	gold	[.020] PG I
alt-gold	antique-gold	[.025] PG K
roségold	rosegold	[.022] PG L
roségold matt	rosegold matt	[.023] PG L

Andere Oberflächen auf Anfrage |
Different colours on request

Auf Anfrage können wir Produkte von Drittanbietern auch gerne passend zu unseren Oberflächen veredeln (vorbehaltlich der Eignungsprüfung) | Third-party products may be plated matching to our colours on request (subject to valuation of suitability)

Waschtisch | Washbasin

ab Seite | from page 320

Bidet | Bidet

ab Seite | from page 320

Wanne | Bath tub

ab Seite | from page 321

Dusche | Shower

ab Seite | from page 322

Accessoires | Accessories

ab Seite | from page 328

APHRODITE

Maßzeichnungen unter www.joerger.de - Menü SERVICE.
 Technical specifications under www.joerger.de - menu SERVICE.

A chrom chrome	[.000]	E platin matt platinum matt	[.066]
B silbernickel polished nickel	[.035]	G schwarz-matt black matt	[.092]
C nerz mink	[.095]	G weiß-matt white matt	[.052]
C nickel matt satin nickel	[.036]	H bronze bronze	[.011]
D edelmessing sunshine	[.040]	I gold gold	[.020]
D platin platinum	[.065]	K alt-gold antique-gold	[.025]
E edelmess.matt sunshine matt	[.041]	L roségold rosegold	[.022]
E gold matt gold matt	[.021]	L roségold matt rosegold matt	[.023]

Variante | Alternative

	649.15.550 Kupferrohr, 500 mm ■ mit Bördel, für Quetschverschraubung	Copper tube, 500 mm ■ with flange, for compression joint	A	B	C	D	E
			20,-	58,-	77,-	87,-	102,-
			G	H	I	K	L
			77,-	96,-	134,-	148,-	219,-

	649.15.340 Waschtisch-Tassensiphon 1 1/4" ■ schwere Ausführung ■ Rosette ■ Abgangsrohr ø 32 mm ■ Tauchrohrlänge 165 mm	Washbasin cupped siphon trap 1 1/4" ■ heavy brass ■ escutcheon ■ outlet tube ø 32 mm ■ dip pipe 165 mm	A	B	C	D	E
			195,-	296,-	368,-	429,-	568,-
			G	H	I	K	L
			378,-	539,-	686,-	755,-	832,-

	649.15.330 Bidet-Tassensiphon 1 1/4" ■ Rosette ■ Abgangsrohr ø 32 mm	Bidet cupped siphon trap 1 1/4" ■ escutcheon ■ outlet tube ø 32 mm	A	B	C	D	E
			98,-	166,-	276,-	332,-	472,-
			G	H	I	K	L
			364,-	508,-	648,-	713,-	796,-

Badewanne, Stand-Batterien | Bath tub mixer sets, deck mount

	607.40.100 4-Loch Wannenfüll- u. Brausebatterie 1/2", für Standmontage ■ Ausladung 176 mm; Höhe 275 mm ■ 2 Seitenrandventile mit keramischen Oberteilen 1/2" ■ Metall-Brauseschlauch 2000 mm ■ Metall-Handbrause mit Anti-Kalk-System und Rückflussverhinderer	Tub/shower mixer set 1/2" deck mount ■ spout projection 176 mm; height 275 mm ■ 2 side valves, ceramic internal upper parts 1/2" ■ metal shower hose 2000 mm ■ metal hand shower with anticalc. system and backflow preventer	A	B	C	D	E
			1.957,-	2.254,-	2.458,-	2.768,-	3.260,-
			G	H	I	K	L
			2.165,-	3.094,-	3.764,-	4.141,-	4.955,-

Empfohlen | Recommended

	649.40.160 Montageplatte, komplett ■ für 4-Loch Armaturen ■ Druckschläuche 1/2"x1/2" x 600 mm ■ Schlauchkastensystem siehe Kapitel "Serienübergreifendes"	Assembly plate, complete ■ for deck mounted tub/shower mixer ■ pressure hoses 1/2"x1/2" x 600 mm ■ system with hose box see chapter "universal products"	A				
			308,-				

	607.40.150 4-Loch Wannenrandkombination 1/2" ■ für Ab- und Überlaufgarnitur mit Wanneneinlauf, ohne Rohrunterbrecher ■ Seitenrandventile, 2-Wege Umstellung ■ Metall-Brauseschlauch 2000 mm ■ Metall-Handbrause mit Anti-Kalk-System und Rückflussverhinderer	tub/shower combination 1/2" ■ for waste and overflow set with bath tub filler spout, without pipe interrupter ■ side valves, 2-position diverter ■ metal shower hose 2000 mm ■ metal hand shower with anticalc. system and backflow preventer	A	B	C	D	E
			1.605,-	1.928,-	2.247,-	2.531,-	2.938,-
			G	H	I	K	L
			1.871,-	2.822,-	3.497,-	3.847,-	4.745,-

Empfohlen | Recommended

	649.40.160 Montageplatte, komplett ■ für 4-Loch Armaturen ■ Druckschläuche 1/2" x 1/2" x 600 mm ■ empfohlen: Schlauchkastensystem siehe Kapitel "Serienübergreifendes"	Assembly plate, complete ■ for deck mounted tub/shower mixer ■ pressure hoses 1/2" x 1/2" x 600 mm ■ recommended: system with hose box see chapter "universal products"	A				
			308,-				

APHRODITE

Maßzeichnungen unter www.joerger.de - Menü SERVICE.
 Technical specifications under www.joerger.de - menu SERVICE.

A chrom chrome	[.000]	E platin matt platinum matt	[.066]
B silbernickel polished nickel	[.035]	G schwarz-matt black matt	[.092]
C nerz milk	[.095]	G weiß-matt white matt	[.052]
C nickel matt satin nickel	[.036]	H bronze bronze	[.011]
D edelmessing sunshine	[.040]	I gold gold	[.020]
D platin platinum	[.065]	K alt-gold antique-gold	[.025]
E edelmess.matt sunshine matt	[.041]	L roségold rosegold	[.022]
E gold matt gold matt	[.021]	L roségold matt rosegold matt	[.023]

607.20.410 – Aufputz Set mit Steigrohr | Exposed set with shower system



649.13.920 Regenbrause ½", ø 200 mm ■ Ausführung ganz in Metall ■ mit Kugelgelenk ■ Anti-Kalk-System	Rain shower head ½", ø 200 mm ■ full metal body ■ with ball joint ■ with anticalcareous system	A	B	C	D	E
		260,-	619,-	824,-	895,-	1.268,-
		G	H	I	K	L
		821,-	1.098,-	1.389,-	1.528,-	2.189,-
649.20.280 Steigrohr, Umstellung, Wandarm ■ zum Anschluß an die Brausebatterie ■ Ausladung 360 - 380 mm ■ in der Neigung und Höhe verstellbare Brausehalterung	Supply pipe, diverter, wall bracket ■ to connect the exposed shower mixer ■ projection 360 - 380 mm ■ fitting for handshower adjustable in height and inclination	A	B	C	D	E
		589,-	932,-	1.198,-	1.362,-	1.741,-
		G	H	I	K	L
		1.318,-	1.649,-	1.895,-	2.085,-	2.529,-
600.13.700 Brausegarnitur ■ Metall-Handbrause mit Anti-Kalk-System und Rückflussverhinderer ■ Brauseschlauch 1500 mm, beidseitig mit drehbarem Konus	Shower combination ■ metal hand shower with anticalc. system and backflow preventer ■ metal shower hose 1500 mm, both sides with turning cone	A	B	C	D	E
		369,-	449,-	551,-	608,-	750,-
		G	H	I	K	L
		734,-	1.019,-	844,-	929,-	1.499,-
607.20.210 Aufputz-Brausebatterie ½" ■ für Steigrohr ■ Brauseabgang ¾" ■ 2 keramische Oberteile ½"	Exposed shower mixer ½" ■ for supply pipe ■ discharge ¾" ■ 2 ceramic internal upper parts ½"	A	B	C	D	E
		530,-	632,-	785,-	883,-	1.041,-
		G	H	I	K	L
		887,-	1.154,-	1.209,-	1.330,-	2.182,-



607.20.250 Brausethermostat ½" für Aufputzmontage ■ Dehnstoff-Thermoelement ■ Sicherheitssperre bei 38° C ■ Keramik-Innenoberteil ½"	Exposed shower thermostat ½" ■ cartridge with thermoelement ■ locking device at 38 °C ■ ceramic cartridge ½"	A	B	C	D	E
		1.098,-	1.492,-	1.655,-	1.774,-	2.398,-
		G	H	I	K	L
		1.744,-	2.150,-	2.689,-	2.958,-	3.165,-

607.20.460 – Aufputz Set mit Steigrohr | Exposed set with shower system







649.13.920 Regenbrause ½", ø 200 mm ■ Ausführung ganz in Metall ■ mit Kugelgelenk ■ Anti-Kalk-System	Rain shower head ½", ø 200 mm ■ full metal body ■ with ball joint ■ with anticalcareous system	A	B	C	D	E
		260,-	619,-	824,-	895,-	1.268,-
		G	H	I	K	L
		821,-	1.098,-	1.389,-	1.528,-	2.189,-
649.20.280 Steigrohr, Umstellung, Wandarm ■ zum Anschluß an die Brausebatterie ■ Ausladung 360 - 380 mm ■ in der Neigung und Höhe verstellbare Brausehalterung	Supply pipe, diverter, wall bracket ■ to connect the exposed shower mixer ■ projection 360 - 380 mm ■ fitting for handshower adjustable in height and inclination	A	B	C	D	E
		589,-	932,-	1.198,-	1.362,-	1.741,-
		G	H	I	K	L
		1.318,-	1.649,-	1.895,-	2.085,-	2.529,-
600.13.700 Brausegarnitur ■ Metall-Handbrause mit Anti-Kalk-System und Rückflussverhinderer ■ Brauseschlauch 1500 mm, beidseitig mit drehbarem Konus	Shower combination ■ metal hand shower with anticalc. system and backflow preventer ■ metal shower hose 1500 mm, both sides with turning cone	A	B	C	D	E
		369,-	449,-	551,-	608,-	750,-
		G	H	I	K	L
		734,-	1.019,-	844,-	929,-	1.499,-
607.20.260 Aufputz-Brausethermostat ½" ■ für Steigrohr ■ Brauseabgang ¾" ■ 2 keramische Oberteile ½"	Exposed shower thermostat ½" ■ for supply pipe ■ discharge ¾" ■ 2 ceramic internal upper parts ½"	A	B	C	D	E
		1.146,-	1.540,-	1.704,-	1.822,-	2.446,-
		G	H	I	K	L
		1.792,-	2.198,-	2.737,-	3.011,-	3.213,-

APHRODITE



Maßzeichnungen unter www.joerger.de - Menü SERVICE.
 Technical specifications under www.joerger.de - menu SERVICE.

A chrom chrome	[.000]	E platin matt platinum matt	[.066]
B silbernickel polished nickel	[.035]	G schwarz-matt black matt	[.092]
C nerz milk	[.095]	G weiß-matt white matt	[.052]
C nickel matt satin nickel	[.036]	H bronze bronze	[.011]
D edelmessing sunshine	[.040]	I gold gold	[.020]
D platin platinum	[.065]	K alt-gold antique-gold	[.025]
E edelmess.matt sunshine matt	[.041]	L roségold rosegold	[.022]
E gold matt gold matt	[.021]	L roségold matt rosegold matt	[.023]



Unterputz-Thermostate 1/2" | Wall thermostats, concealed 1/2"

	607.40.380 Unterputz-Thermostat 1/2" mit Mengenregulierung, Fertigmontageset <ul style="list-style-type: none"> manuelle, keramische Umstellung Wanne/Brause, druckunabhängig mit Sicherheitseinrichtung Durchflussrate 20,4 l/min bei 3 bar 	Concealed wall thermostat 1/2" with flow control, assembly set <ul style="list-style-type: none"> manual, ceramic diverter tub/shower for pressure-independent function with safety device flow rate 20,4 l/min at 3 bar 	A	B	C	D	E
			1.137,-	1.174,-	1.594,-	1.634,-	1.932,-
	607.40.360 Unterputz-Thermostat 1/2" mit Mengenregulierung, Fertigmontageset <ul style="list-style-type: none"> ohne Umstellung mit integrierter keramischer Mengenregulierung Durchflussrate 20,4 l/min bei 3 bar 	Concealed wall thermostat 1/2" with flow control, assembly set <ul style="list-style-type: none"> without diverter with integrated ceramic cartridge for volume control flow rate 20,4 l/min at 3 bar 	A	B	C	D	E
			1.102,-	1.174,-	1.559,-	1.598,-	1.897,-
	637.40.460 Unterputz-Thermostat 1/2" ohne Mengenregulierung, Fertigmontageset <ul style="list-style-type: none"> Funktionseinheit ohne Umstellung und ohne Absperrung Durchflussrate 25,8 l/min bei 3 bar 	Concealed wall thermostat 1/2" without flow control, assembly set <ul style="list-style-type: none"> Functional unit without diverter and without shut-off flow rate 25,8 l/min at 3 bar 	A	B	C	D	E
			884,-	1.038,-	1.220,-	1.279,-	1.539,-
Benötigt Required			A				
	649.40.360 Unterputz-Einbaubox 1/2" <ul style="list-style-type: none"> zu Fertigmontageset 607.40.360, 607.40.380 und 637.40.460 für Nass- und Trockenbau geeignet 	Concealed wall box 1/2" <ul style="list-style-type: none"> for assembly set 607.40.360, 607.40.380 and 637.40.460 for wetwall and drywall construction 	A				
			168,-				

Unterputz-Thermostat 3/4" mit hohem Durchfluß | Wall thermostat, concealed 3/4" with high flow

	607.40.560 Unterputz-Thermostat 3/4" ohne Mengenregulierung, Fertigmontageset <ul style="list-style-type: none"> serienbezogener Temperiergriff Sicherheitssperre bei 38° C 	Concealed wall thermostat 3/4" without flow control, assembly set <ul style="list-style-type: none"> design handle for temp. control locking device at 38°C 	A	B	C	D	E
			618,-	782,-	1.074,-	1.124,-	1.433,-
	649.40.555 Unterputz-Einbaukörper 3/4" <ul style="list-style-type: none"> zu Fertigmontageset 607.40.555 Kartusche mit Schmutzfangsieben für Nass- und Trockenbau geeignet Durchflussrate 64,2 l/min bei 3 bar ohne Absperrung 	Concealed thermostat body 3/4" <ul style="list-style-type: none"> for assembly set 607.40.555 cartridge with filter screens for wetwall and drywall construction flow rate 64,2 l/min at 3 bar without shut-off 	A				
			1.636,-				

Unterputz-Thermostat 3/4" | Wall thermostat, concealed 3/4"











	607.40.520 Unterputz-Thermostat 3/4" ohne Mengenregulierung, Fertigmontageset <ul style="list-style-type: none"> serienbezogener Temperiergriff Sicherheitssperre bei 38° C 	Concealed wall thermostat 3/4" without flow control, assembly set <ul style="list-style-type: none"> design handle for temp. control locking device at 38°C 	A	B	C	D	E
			618,-	782,-	1.074,-	1.124,-	1.433,-
	649.40.520 Unterputz-Einbaukörper 3/4" <ul style="list-style-type: none"> zu Fertigmontageset 607.40.520 Kartusche mit Schmutzfangsieben für Nass- und Trockenbau geeignet Durchflussrate 41 l/min bei 3 bar ohne Absperrung 	Concealed thermostat body 3/4" <ul style="list-style-type: none"> for assembly set 607.40.520 cartridge with filter screens for wetwall and drywall construction flow rate 41 l/min at 3 bar without shut-off 	A				
			498,-				

APHRODITE

Maßzeichnungen unter www.joerger.de - Menü SERVICE.
 Technical specifications under www.joerger.de - menu SERVICE.

A chrom chrome	[.000]	E platin matt platinum matt	[.066]
B silbernickel polished nickel	[.035]	G schwarz-matt black matt	[.092]
C nerz milk	[.095]	G weiß-matt white matt	[.052]
C nickel matt satin nickel	[.036]	H bronze bronze	[.011]
D edelmessing sunshine	[.040]	I gold gold	[.020]
D platin platinum	[.065]	K alt-gold antique-gold	[.025]
E edelmess.matt sunshine matt	[.041]	L roségold rosegold	[.022]
E gold matt gold matt	[.021]	L roségold matt rosegold matt	[.023]

Unterputz-Thermostat/Ventil-Modul | Concealed thermostatic/wall-valve modul

			A	B	C	D	E
	607.60.432 Unterputz-Ventil-Modul Fertigmontageset	Concealed wall-valve-modul assembly set	320,-	389,-	447,-	504,-	590,-
	<ul style="list-style-type: none"> Griff Rosette 	<ul style="list-style-type: none"> design handle escutcheon 					
	Benötigt Required						
	649.20.610 Unterputz-Ventil-Modul, 1-fach	Concealed wall-valve-modul, single	229,-				
	<ul style="list-style-type: none"> 1x Spindelventil 3/4", rechtsschließend mit keram. Scheiben 2 Abgänge 1/2", je 1x rechts/links möglich, gleichzeitig benutzbar 	<ul style="list-style-type: none"> 1x spindle valve 3/4", clockwise closure with ceramic discs 2 outlets 1/2", each 1x right/left possible, simultaneously usable 					
	Benötigt Required						
	649.20.620 Unterputz-Ventil-Modul, 2-fach	Concealed wall-valve-modul, double	458,-				
	<ul style="list-style-type: none"> 2x Spindelventil 3/4", rechtsschließend mit keram. Scheiben 4 Abgänge 1/2", je 2x rechts/links möglich, gleichzeitig benutzbar im Verbund maßgenaue Montage erweiterbar mit 649.20.610 	<ul style="list-style-type: none"> 2x spindle valve 3/4", clockwise closure with ceramic discs 4 outlets 1/2", each 2x right/left possible, simultaneously usable precise assembly due to composite expandable with 649.20.610 					
	Benötigt Required						
	649.20.630 Unterputz-Ventil-Modul, 3-fach	Concealed wall-valve-modul, triple	686,-				
	<ul style="list-style-type: none"> 3x Spindelventil 3/4", rechtsschließend mit keram. Scheiben 6 Abgänge 1/2", je 3x rechts/links möglich, gleichzeitig benutzbar im Verbund maßgenauen Montage erweiterbar mit 649.20.610 	<ul style="list-style-type: none"> 3x spindle valve 3/4", clockwise closure with ceramic discs 6 outlets 1/2", each 3x right/left possible, simultaneously usable precise assembly due to composite expandable with 649.20.610 					
	Benötigt Required						
	637.40.460 Unterputz-Thermostat 1/2" ohne Mengenregulierung, Fertigmontageset	Concealed wall thermostat 1/2" without flow control, assembly set	884,-	1.038,-	1.220,-	1.279,-	1.539,-
	<ul style="list-style-type: none"> Funktionseinheit ohne Umstellung und ohne Absperrung Durchflussrate 25,8 l/min bei 3 bar 	<ul style="list-style-type: none"> Functional unit without diverter and without shut-off flow rate 25,8 l/min at 3 bar 					
	Benötigt Required						
	649.20.612 Anschlußadapter 1/2"	Connection adapter 1/2"	122,-				
	<ul style="list-style-type: none"> Anschlußadapter, Abschlußstopfen passend zu Einbaubox 649.40.360 	<ul style="list-style-type: none"> connection adapter, end plug matching to wall box 649.40.360 					
	Benötigt Required						
	649.40.360 Unterputz-Einbaubox 1/2"	Concealed wall box 1/2"	168,-				
	<ul style="list-style-type: none"> zu Fertigmontageset 637.40.460 für Nass- und Trockenbau geeignet 	<ul style="list-style-type: none"> for assembly set 637.40.460 for wetwall and drywall construction 					
	Benötigt Required						
	607.40.560 Unterputz-Thermostat 3/4" ohne Mengenregulierung, Fertigmontageset	Concealed wall thermostat 3/4" without flow control, assembly set	618,-	782,-	1.074,-	1.124,-	1.433,-
	<ul style="list-style-type: none"> serienbezogener Temperiergriff Sicherheitsperre bei 38° C 	<ul style="list-style-type: none"> design handle for temp. control locking device at 38° C 					
	Benötigt Required						
	649.20.634 Anschlußadapter 3/4"	Connection adapter 3/4"	146,-				
	<ul style="list-style-type: none"> Anschlußadapter, Abschlußstopfen passend zu Einbaukörper 649.40.555 	<ul style="list-style-type: none"> connection adapter, end plug matching to wall body 649.40.555 					
	Benötigt Required						
	649.40.555 Unterputz-Einbaukörper 3/4"	Concealed thermostat body 3/4"	1.636,-				
	<ul style="list-style-type: none"> zu Fertigmontageset 607.40.555 Kartusche mit Schmutzfangsieben für Nass- und Trockenbau geeignet Durchflussrate 64,2 l/min bei 3 bar ohne Absperrung 	<ul style="list-style-type: none"> for assembly set 607.40.555 cartridge with filter screens for wetwall and drywall construction flow rate 64,2 l/min at 3 bar without shut-off 					
	Benötigt Required						

APHRODITE

Maßzeichnungen unter www.joerger.de - Menü SERVICE.
 Technical specifications under www.joerger.de - menu SERVICE.

A chrom chrome	[.000]	E platin matt platinum matt	[.066]
B silbernickel polished nickel	[.035]	G schwarz-matt black matt	[.092]
C nerz milk	[.095]	G weiß-matt white matt	[.052]
C nickel matt satin nickel	[.036]	H bronze bronze	[.011]
D edelmessing sunshine	[.040]	I gold gold	[.020]
D platin platinum	[.065]	K alt-gold antique-gold	[.025]
E edelmess.matt sunshine matt	[.041]	L roségold rosegold	[.022]
E gold matt gold matt	[.021]	L roségold matt rosegold matt	[.023]

Unterputz-Umstellung und Ventile | Diverter and valves concealed

	607.40.650 Unterputz 3-Wege Umstellung ½" Fertigmontageset ■ Griff ■ Hülse, Schubrosette	Concealed 3-position diverter ½" assembly set ■ design handle ■ socket with adjustable escutcheon	A	B	C	D	E
			320,-	390,-	447,-	504,-	590,-
			G	H	I	K	L
			288,-	572,-	698,-	768,-	785,-

Benötigt | Required

	649.40.600 Unterputz 3-Wege Umstellung ½" Einbaukörper ■ zu Fertigmontageset 607.40.650	Concealed 3-position diverter ½" diverter body ■ for assembly set 607.40.650	A				
			236,-				

Unterputz-Ventile | Valves concealed

	607.50.234 Unterputz-Ventil Fertigmontageset ■ Griff ■ Hülse, Schubrosette	Concealed wall valve assembly set ■ design handle ■ socket with adjustable escutcheon	A	B	C	D	E
			275,-	346,-	385,-	434,-	511,-
			G	H	I	K	L
			264,-	489,-	604,-	665,-	763,-

Benötigt | Required

	649.20.340 Unterputz-Ventil ½", Einbaukörper ■ rechtsschließend, ker. Scheiben	Concealed wall valve ½", body ■ clockwise closure, ceramic discs	A				
			62,-				

	649.20.345 Unterputz-Ventil ½", Einbaukörper ■ linksschließend, ker. Scheiben	Concealed wall valve ½", body ■ counter-clockwise closure, cer. discs	A				

	649.20.440 Unterputz-Ventil ¾", Einbaukörper ■ rechtsschließend, ker. Scheiben	Concealed wall valve ¾", body ■ clockwise closure, ceramic discs	A				
			106,-				

	649.20.445 Unterputz-Ventil ¾", Einbaukörper ■ linksschließend, ker. Scheiben	Concealed wall valve ¾", body ■ counter-clockwise closure, cer. discs	A				

Brausen | Showers

	607.13.310 Duschgarnitur, komplett ■ Wandrohr 780 mm, mit Schieber ■ Metall-Handbrause mit Anti-Kalk-System und Rückflussverhinderer ■ Metall-Brauseschlauch 1750 mm, beidseitig mit drehbarem Konus	Shower bar set, complete ■ wall bar 780 mm, with slider ■ metal hand shower with anticalc. system and backflow preventer ■ metal shower hose 1750 mm, both sides with turning cone	A	B	C	D	E
			1.398,-	1.612,-	1.664,-	1.764,-	2.089,-
			G	H	I	K	L
			1.868,-	2.309,-	2.398,-	2.638,-	3.634,-

	607.13.350 Duschstange, lose ■ Wandrohr 780 mm, mit Schieber	Shower bar, separate ■ wall bar 780 mm, with slider	A	B	C	D	E
			1.032,-	1.152,-	1.168,-	1.273,-	1.500,-

			G	H	I	K	L
			1.151,-	1.399,-	1.776,-	1.954,-	2.258,-

	607.13.200 Schlauchbrausegarnitur ■ Wandanschlußbogen ½", Schubrosette, Wand-Brausehalter ■ Metall-Handbrause mit Anti-Kalk-System und Rückflussverhinderer ■ Metall-Brauseschlauch 1500 mm	Shower combination ■ wall elbow connection ½" ■ wall fitting for hand shower ■ metal hand shower with anticalc. system and backflow preventer ■ flexible metal shower hose 1500 mm	A	B	C	D	E
			595,-	699,-	788,-	887,-	1.045,-
			G	H	I	K	L
			951,-	1.254,-	1.166,-	1.283,-	1.786,-

	607.13.150 Wandanschlußbogen ½", ohne Haken ■ Brauseabgang ½" ■ mit Rückflussverhinderer, Rosette	Wall elbow connection ½", without cradle ■ discharge ½" ■ with backflow preventer, escutcheon	A	B	C	D	E
			108,-	114,-	154,-	173,-	205,-

			G	H	I	K	L
			160,-	198,-	236,-	260,-	315,-

APHRODITE

Maßzeichnungen unter www.joerger.de - Menü SERVICE.
 Technical specifications under www.joerger.de - menu SERVICE.

A chrom chrome	[.000]	E platin matt platinum matt	[.066]
B silbernickel polished nickel	[.035]	G schwarz-matt black matt	[.092]
C nerz mink	[.095]	G weiß-matt white matt	[.052]
C nickel matt satin nickel	[.036]	H bronze bronze	[.011]
D edelmessing sunshine	[.040]	I gold gold	[.020]
D platin platinum	[.065]	K alt-gold antique-gold	[.025]
E edelmess.matt sunshine matt	[.041]	L roségold rosegold	[.022]
E gold matt gold matt	[.021]	L roségold matt rosegold matt	[.023]



649.13.210 Wand-Brausehalter

Wall fitting for hand shower

A	B	C	D	E
178,-	214,-	266,-	287,-	337,-
G	H	I	K	L
256,-	325,-	374,-	412,-	459,-



607.13.237 Hygienebrausegarnitur

- Wandbrausehalter und -anschlußbogen 1/2", Schubrosette
- Hygienebrause, klassisch (649.13.338), komplett aus Metall
- einstrahlig, Bedienung über Druckhebel
- Metall-Brauseschlauch 1250 mm

Ablution spray combination

- wall fitting and elbow connection 1/2"
- spray handshower, classical (649.13.338), completely metal
- one jet, push-lever operation
- flexible metal shower hose 1250 mm

A	B	C	D	E
342,-	544,-	654,-	685,-	904,-
G	H	I	K	L
673,-	998,-	1.145,-	1.260,-	1.531,-



607.20.237 1-Hand Batterie 1/2" für Hygiene-Brause, Fertigmontageset

- Rosette, Griff
- mit Hebelgriff

Concealed single lever 1/2" for ablution spray, assembly set

- escutcheon, handle
- with lever handle

A	B	C	D	E
296,-	378,-	490,-	552,-	649,-
G	H	I	K	L
534,-	612,-	754,-	830,-	911,-

Benötigt | Required



649.20.237 Unterputz 1-Hand Batterie 1/2", Einbaukörper

- Kartusche mit keramischen Scheiben
- zu Fertigmontageset 607.20.237

Single lever mixer 1/2", concealed body

- cartridge with ceramic discs
- for assembly set 607.20.237

A	B	C	D	E
125,-	169,-	208,-	229,-	268,-
G	H	I	K	L
224,-	258,-	329,-	362,-	396,-



649.13.615 Stachelkopfbrause 1/2"

- ø 230 mm, 75 Düsen
- Ausführung ganz in Metall
- Anti-Kalk-System
- Brausekopf schwenkbar
- ohne Wandarm

Body spray shower head 1/2"

- ø 230 mm, 75 jets
- full metal body
- anticalcareous system
- swivel shower head
- without wall bracket

A	B	C	D	E
969,-	1.232,-	1.359,-	1.416,-	1.659,-
G	H	I	K	L
1.399,-	1.718,-	2.262,-	2.489,-	2.739,-

- weitere, zur Serie passende Kopfbrausen siehe Kapitel "Brausen"

- for further shower heads matching this collection see chapter "showers"

Empfohlen | Recommended



649.13.625 Wandarm 1/2"

- Ausladung 162 mm

Wall bracket 1/2"

- projection 162 mm

- weitere, zur Serie passende Wandarme siehe Kapitel "Brausen"

- for further wall brackets matching this collection see chapter "showers"

A	B	C	D	E
126,-	145,-	171,-	189,-	250,-
G	H	I	K	L
192,-	296,-	286,-	315,-	499,-



649.13.519 Seitenbrause 1/2"

- Rosette ø 130 mm, Wandmontage
- Brausekopf schwenkbar, 20°
- Anti-Kalk-System
- Ausführung Kunststoff

Body spray side shower 1/2"

- escutcheon ø 130 mm, wall assembly
- swivel shower head, 20°
- anticalcareous system
- plastic

- weitere, zur Serie passende Seitenbrausen siehe Kapitel "Brausen"

- for further side showers matching this collection see chapter "showers"



A	B	C	D	E
167,-	326,-	385,-	399,-	542,-
G	H	I	K	L
376,-	472,-	634,-	698,-	949,-

APHRODITE

Maßzeichnungen unter www.joerger.de - Menü SERVICE.
 Technical specifications under www.joerger.de - menu SERVICE.

A chrom chrome	[.000]	E platin matt platinum matt	[.066]
B silbernickel polished nickel	[.035]	G schwarz-matt black matt	[.092]
C nerz mink	[.095]	G weiß-matt white matt	[.052]
C nickel matt satin nickel	[.036]	H bronze bronze	[.011]
D edelmessing sunshine	[.040]	I gold gold	[.020]
D platin platinum	[.065]	K alt-gold antique-gold	[.025]
E edelmess.matt sunshine matt	[.041]	L roségold rosegold	[.022]
E gold matt gold matt	[.021]	L roségold matt rosegold matt	[.023]

Accessoires für Handtücher | Accessories for towels

	607.00.002 Handtuchhalter, doppelt ■ Rohre schwenkbar, ca. 430 mm	Double towel bar ■ swivelling bars, approx. 430 mm	A	B	C	D	E
			498,-	634,-	669,-	752,-	885,-
	607.00.012 Handtuchhalter, doppelt ■ verkürzt, ca. 300 mm	Double towle bar ■ shortened, approx. 300 mm	G	H	I	K	L
			697,-	799,-	956,-	1.052,-	1.285,-

	607.00.047 Handtuchring ■ ø ca. 190 mm ■ geschlossene Ausführung	Towel ring ■ ø approx. 190 mm ■ closed version	A	B	C	D	E
			464,-	529,-	546,-	614,-	717,-
			G	H	I	K	L
			563,-	625,-	774,-	852,-	982,-

	607.00.022 Handtuchhaken	Robe hanger	A	B	C	D	E
			279,-	316,-	362,-	409,-	482,-
			G	H	I	K	L
			358,-	425,-	537,-	591,-	637,-

	607.00.040 Badetuchhalter ■ ca. 800 mm	Bath towel bar ■ approx. 800 mm	A	B	C	D	E
			875,-	1.096,-	1.116,-	1.149,-	1.378,-
			G	H	I	K	L
			982,-	1.212,-	1.485,-	1.634,-	2.027,-

	607.00.031 Wannengriff ■ ca. 400 mm	Tub handle ■ approx. 400 mm	A	B	C	D	E
			759,-	956,-	984,-	1.004,-	1.182,-
			G	H	I	K	L
			889,-	1.042,-	1.306,-	1.437,-	1.533,-

	607.00.104 Gästehandtuchkorb, eckig ■ mit Ablage ■ Korbgröße 260 x 150 x 190 mm	Guest towel basket, angular ■ with shelf ■ basket size 260 x 150 x 190 mm	A	B	C	D	E
			493,-	595,-	708,-	797,-	938,-
			G	H	I	K	L
			652,-	1.059,-	1.021,-	1.124,-	1.968,-

Accessoires für Waschplatz | Accessories for washstands

	607.00.007 Seifenhalter, komplett ■ Seifenschale aus Kristallglas	Soap dish holder, complete ■ crystal glass dish	A	B	C	D	E
			413,-	439,-	540,-	606,-	708,-
			G	H	I	K	L
			455,-	626,-	788,-	867,-	946,-

701.00.307 Seifenschale, lose	Glass dish, separate	A					
		89,-					

APHRODITE

Maßzeichnungen unter www.joerger.de - Menü SERVICE.
 Technical specifications under www.joerger.de - menu SERVICE.

A chrom chrome	[.000]	E platin matt platinum matt	[.066]
B silbernickel polished nickel	[.035]	G schwarz-matt black matt	[.092]
C nerz milk	[.095]	G weiß-matt white matt	[.052]
C nickel matt satin nickel	[.036]	H bronze bronze	[.011]
D edelmessing sunshine	[.040]	I gold gold	[.020]
D platin platinum	[.065]	K alt-gold antique-gold	[.025]
E edelmess.matt sunshine matt	[.041]	L roségold rosegold	[.022]
E gold matt gold matt	[.021]	L roségold matt rosegold matt	[.023]

	607.00.105 Schwammkorb ■ rechteckig, 260 x 130 mm	Sponge basket ■ rectangular, 260 x 130 mm	A	B	C	D	E
			468,-	582,-	626,-	658,-	828,-
			G	H	I	K	L
			640,-	820,-	906,-	997,-	1.328,-

	607.00.106 Eckschwammkorb ■ 195 x 195 mm	Corner sponge basket ■ 195 x 195 mm	A	B	C	D	E
			467,-	548,-	580,-	652,-	766,-
			G	H	I	K	L
			636,-	745,-	838,-	922,-	1.237,-

	607.00.006 Lotionspender, komplett	Soap dispenser, complete	A	B	C	D	E
			480,-	548,-	586,-	612,-	720,-
			G	H	I	K	L
			565,-	637,-	802,-	883,-	956,-

	713.00.306 Lotionspenderglas, lose ■ seidenmatt, ohne Pumpe	Soap dispenser glass, separate ■ frosted, without pump	A				
			78,-				

	607.00.036 Glashalter, komplett ■ Glas aus Kristallglas	Tumbler holder, complete ■ crystal glass tumbler	A	B	C	D	E
			435,-	509,-	548,-	616,-	719,-
			G	H	I	K	L
			512,-	638,-	807,-	888,-	995,-

	700.00.336 Mundglas, lose	Glass tumbler, separate	A				
			96,-				

	607.00.009 Ablage, 600 mm ■ Glasplatte aus Kristallglas	Shelf holder with glass, 600 mm ■ crystal glass shelf	A	B	C	D	E
			858,-	898,-	912,-	936,-	1.103,-
			G	H	I	K	L
			892,-	989,-	1.212,-	1.334,-	1.474,-

Accessoires für WC-Bereich | Accessories for w.c. area

	607.00.014 Papierhalter ■ mit Deckel	Toilet paper roll holder ■ with lid	A	B	C	D	E
			530,-	536,-	682,-	768,-	907,-
			G	H	I	K	L
			587,-	799,-	1.009,-	1.110,-	1.232,-

	607.00.015 Reserve-Papierhalter	Spare toilet paper roll holder	A	B	C	D	E
			380,-	459,-	498,-	558,-	650,-
			G	H	I	K	L
			437,-	576,-	723,-	796,-	870,-

APHRODITE

Maßzeichnungen unter www.joerger.de - Menü SERVICE.
 Technical specifications under www.joerger.de - menu SERVICE.

A chrom chrome	[.000]	E platin matt platinum matt	[.066]
B silbernickel polished nickel	[.035]	G schwarz-matt black matt	[.092]
C nerz mink	[.095]	G weiß-matt white matt	[.052]
C nickel matt satin nickel	[.036]	H bronze bronze	[.011]
D edelmessing sunshine	[.040]	I gold gold	[.020]
D platin platinum	[.065]	K alt-gold antique-gold	[.025]
E edelmess.matt sunshine matt	[.041]	L roségold rosegold	[.022]
E gold matt gold matt	[.021]	L roségold matt rosegold matt	[.023]



607.00.000	Klosettbürstengarnitur, komplett ■ Glas aus Kristallglas, seidenmatt	Toilet brush holder set, complete ■ crystal glass, frosted	A	B	C	D	E
			638,-	782,-	789,-	870,-	1.023,-
799.00.300	Bürstenglas, seidenmatt, lose	Brush glass, frosted, separate	A				
			48,-				
651.00.053	Bürstenstange komplett, lose	Brush rod with brush, separate	A	B	C	D	E
			121,-	148,-	176,-	197,-	232,-
799.00.224	Bürstenkopf, lose	Brush, separate	A				
			19,-				

Leuchten und Spiegel | Lamps and mirrors



607.00.061	Wandleuchte, komplett Leuchtenglas klar ■ mit Leuchtmittel, 40 W	Wall lamp, complete Glass clear ■ light bulb included, 40 W	A	B	C	D	E
			689,-	789,-	937,-	1.054,-	1.240,-
707.00.361	Leuchtenglas, lose ■ Leuchtenglas klar	Glass, separate ■ glass clear	A				
			284,-				



607.00.063	Wandleuchte, komplett Leuchtenglas matt ■ mit Leuchtmittel, 40 W	Wall lamp, complete Glass frosted ■ light bulb included, 40 W	A	B	C	D	E
			782,-	809,-	1.073,-	1.207,-	1.422,-
707.00.363	Leuchtenglas, lose ■ Leuchtenglas matt	Glass, separate ■ glass frosted	A				
			356,-				



649.00.414	Kosmetikspiegel, beleuchtet ■ schwenk- und ausziehbar ■ 3-fache Vergrößerung ■ Direktanschluss ■ Spiegeldurchmesser 185 mm ■ Rahmendurchmesser 250 mm ■ Kalt-, Warm- und Taglicht durch Piezzo-Schalter umschaltbar	Cosmetic mirror, incl. lighting ■ swivelling and extendable ■ magnification 3:1 ■ direct connection ■ mirror diameter 185 mm ■ frame diameter 250 mm ■ cold, warm and day light switchable by Piezzo switch	A	B	C	D	E
			556,-	988,-	1.214,-	1.418,-	1.828,-
			G	H	I	K	L
			1.214,-	1.549,-	2.138,-	2.352,-	2.998,-



Oberflächen | colours

Folgende Oberflächen sind bei dieser Serie möglich |
The following colours are possible with this collection

chrom	chrome	[.000]	PG A
silbernickel	polished nickel	[.035]	PG B
nerz	mink	[.095]	PG C
nickel matt	satin nickel	[.036]	PG C
edelmessing	sunshine	[.040]	PG D
platin	platinum	[.065]	PG D
edelmessing matt	sunshine matt	[.041]	PG E
gold matt	gold matt	[.021]	PG E
platin matt	platinum matt	[.066]	PG E
nerz matt	mink matt	[.096]	PG F
schwarz matt	black matt	[.092]	PG G
weiß matt	white matt	[.052]	PG G
bronze	bronze	[.011]	PG H
gold	gold	[.020]	PG I
roségold	rosegold	[.022]	PG L
roségold matt	rosegold matt	[.023]	PG L

Andere Oberflächen auf Anfrage |
Different colours on request

Auf Anfrage können wir Produkte von Drittanbietern auch gerne passend zu unseren Oberflächen veredeln (vorbehaltlich der Eignungsprüfung) | Third-party products may be plated matching to our colours on request (subject to valuation of suitability)

Waschtisch | Washbasin

ab Seite | from page 332

Bidet | Bidet

ab Seite | from page 332

Wanne | Bath tub

ab Seite | from page 333

Dusche | Shower

ab Seite | from page 334

Accessoires | Accessories

ab Seite | from page 340

MUSCHEL

Maßzeichnungen unter www.joerger.de - Menü SERVICE.
 Technical specifications under www.joerger.de - menu SERVICE.

A chrom chrome	[.000]	E platin matt platinum matt	[.066]
B silbernickel polished nickel	[.035]	F nerz matt mink matt	[.096]
C nerz mink	[.095]	G schwarz-matt black matt	[.092]
C nickel matt satin nickel	[.036]	G weiß-matt white matt	[.052]
D edelmessing sunshine	[.040]	H bronze bronze	[.011]
D platin platinum	[.065]	I gold gold	[.020]
E edelmess.matt sunshine matt	[.041]	L roségold rosegold	[.022]
E gold matt gold matt	[.021]	L roségold matt rosegold matt	[.023]

Waschtisch Batterien | Washbasin mixer

	601.30.300 Waschtisch 3-Loch Batterie 1/2" <ul style="list-style-type: none"> Ausladung 155 mm; Höhe 140 mm 2 Seitenrandventile mit keramischen Oberteilen 1/2" Exzenter-Ablaufgarnitur 1 1/4" empfohlen: 2x 649.15.530 - Kupferrohr 300 mm 	Washbasin 3-hole mixer 1/2" <ul style="list-style-type: none"> spout projection 155 mm; height 140 mm 2 side valves with ceramic internal upper parts 1/2" pop-up waste 1 1/4" recommended: 2x 649.15.530 - copper tube 300 mm 	A	B	C	D	E
			1.495,-	1.732,-	2.021,-	2.275,-	2.680,-
			F	G	H	I	L
			2.417,-	1.780,-	2.365,-	3.124,-	3.505,-

	601.30.200 Handwaschbecken 3-Loch Batterie 1/2" <ul style="list-style-type: none"> Ausladung 88 mm; Höhe 106 mm 2 Seitenrandventile mit keramischen Oberteilen 1/2" Exzenter-Ablaufgarnitur 1 1/4" empfohlen: 2x 649.15.530 - Kupferrohr 300 mm 	Mini washbasin 3-hole mixer 1/2" <ul style="list-style-type: none"> spout projection 88 mm; height 106 mm 2 side valves with ceramic internal upper parts 1/2" pop-up waste 1 1/4" recommended: 2x 649.15.530 - copper tube 300 mm 	A	B	C	D	E
			1.428,-	1.667,-	1.934,-	2.176,-	2.564,-
			F	G	H	I	L
			2.379,-	1.775,-	2.260,-	2.972,-	4.331,-

	601.10.300 Waschtisch 1-Loch Batterie 1/2" <ul style="list-style-type: none"> Ausladung 125 mm; Höhe 165 mm Keramik-Innenoberteile 1/2" Exzenter-Ablaufgarnitur 1 1/4" 2 Kupferrohre M10x1 x 400 mm 	Washbasin 1-hole mixer 1/2" <ul style="list-style-type: none"> spout projection 125 mm; height 165 mm ceramic internal upper parts 1/2" pop-up waste 1 1/4" 2 copper tubes M10x1 x 400 mm 	A	B	C	D	E
			939,-	1.114,-	1.317,-	1.482,-	1.746,-
			F	G	H	I	L
			1.670,-	1.358,-	1.534,-	2.118,-	2.776,-

	601.10.500 Wand-Auslaufventil 1/2" <ul style="list-style-type: none"> Ausladung 95 mm; Höhe 94 mm Fettkammer-Innenoberteil 1/2" 	Wall tap 1/2" <ul style="list-style-type: none"> spout projection 95 mm; height 94 mm cartridge 1/2" 	A	B	C	D	E
			258,-	318,-	375,-	422,-	498,-
			F	G	H	I	L
			462,-	669,-	532,-	583,-	859,-

	601.10.400 Standventil 1/2" <ul style="list-style-type: none"> Ausladung 95 mm; Höhe 86 mm starrer Auslauf Fettkammer-Innenoberteil 1/2" 	Deck mount tap 1/2" <ul style="list-style-type: none"> spout projection 86 mm; height 94 mm rigid spout cartridge 1/2" 	A	B	C	D	E
			209,-	235,-	324,-	364,-	445,-
			F	G	H	I	L
			398,-	639,-	666,-	541,-	874,-

Bidet Batterien | Bidet mixer

	601.30.100 Bidet 3-Loch Batterie 1/2" <ul style="list-style-type: none"> Ausladung 100 mm; Höhe 106 mm 2 Seitenrandventile mit keramischen Oberteilen 1/2" Exzenter-Ablaufgarnitur 1 1/4" empfohlen: 2x 649.15.530 - Kupferrohr 300 mm 	Bidet 3-hole mixer 1/2" <ul style="list-style-type: none"> spout projection 100 mm; height 106 mm 2 side valves with ceramic internal upper parts 1/2" pop-up waste 1 1/4" recommended: 2x 649.15.530 - copper tube 300 mm 	A	B	C	D	E
			1.458,-	1.700,-	1.972,-	2.220,-	2.614,-
			F	G	H	I	L
			2.420,-	1.798,-	2.304,-	3.048,-	4.442,-





	601.10.100 Bidet 1-Loch Batterie 1/2" <ul style="list-style-type: none"> Ausladung 110 mm; Höhe 112 mm Keramik-Innenoberteile 1/2" Exzenter-Ablaufgarnitur 1 1/4" 2 Kupferrohre M10x1 x 400 mm 	Bidet 1-hole mixer 1/2" <ul style="list-style-type: none"> spout projection 110 mm; height 112 mm ceramic internal upper parts 1/2" pop-up waste 1 1/4" 2 copper tubes M10x1 x 400 mm 	A	B	C	D	E
			1.026,-	1.215,-	1.439,-	1.620,-	1.907,-
			F	G	H	I	L
			1.762,-	989,-	1.675,-	2.259,-	2.409,-

MUSCHEL



Maßzeichnungen unter www.joerger.de - Menü SERVICE.
 Technical specifications under www.joerger.de - menu SERVICE.

A chrom chrome	[.000]	E platin matt platinum matt	[.066]
B silbernickel polished nickel	[.035]	F nerz matt mink matt	[.096]
C nerz mink	[.095]	G schwarz-matt black matt	[.092]
C nickel matt satin nickel	[.036]	G weiß-matt white matt	[.052]
D edelmessing sunshine	[.040]	H bronze bronze	[.011]
D platin platinum	[.065]	I gold gold	[.020]
E edelmess.matt sunshine matt	[.041]	L roségold rosegold	[.022]
E gold matt gold matt	[.021]	L roségold matt rosegold matt	[.023]

Zubehör für Waschtisch- und Bidet-Batterien | Supplies for washbasin and bidet mixer

	601.12.100 Eckventil 1/2" <ul style="list-style-type: none"> Ausladung 130 mm Fettkammer-Innenoberteil 1/2" Quetschverschraubung Schubrosette 	Angle valve 1/2" <ul style="list-style-type: none"> projection 130 mm cartridge 1/2" compression joint escutcheon 	A	B	C	D	E
			233,-	304,-	315,-	354,-	418,-
			F	G	H	I	L
			394,-	313,-	484,-	488,-	728,-
<hr/>							
	649.15.530 Kupferrohr, 300 mm <ul style="list-style-type: none"> mit Bördel, für Quetschverschraubung 	Copper tube, 300 mm <ul style="list-style-type: none"> with flange, for compression joint 	A	B	C	D	E
			15,-	38,-	55,-	62,-	74,-
			F	G	H	I	L
			69,-	75,-	94,-	112,-	169,-
<hr/>							
Variante Alternative							
	649.15.550 Kupferrohr, 500 mm <ul style="list-style-type: none"> mit Bördel, für Quetschverschraubung 	Copper tube, 500 mm <ul style="list-style-type: none"> with flange, for compression joint 	A	B	C	D	E
			20,-	58,-	77,-	87,-	102,-
			F	G	H	I	L
			97,-	77,-	96,-	134,-	219,-
<hr/>							
	649.15.340 Waschtisch-Tassensiphon 1 1/4" <ul style="list-style-type: none"> schwere Ausführung Rosette Abgangsrohr ø 32 mm Tauchrohrlänge 165 mm 	Washbasin cupped siphon trap 1 1/4" <ul style="list-style-type: none"> heavy brass escutcheon outlet tube ø 32 mm dip pipe 165 mm 	A	B	C	D	E
			195,-	296,-	368,-	429,-	568,-
			F	G	H	I	L
			498,-	378,-	539,-	686,-	832,-
<hr/>							
	649.15.330 Bidet-Tassensiphon 1 1/4" <ul style="list-style-type: none"> Rosette Abgangsrohr ø 32 mm 	Bidet cupped siphon trap 1 1/4" <ul style="list-style-type: none"> escutcheon outlet tube ø 32 mm 	A	B	C	D	E
			98,-	166,-	276,-	332,-	472,-
			F	G	H	I	L
			399,-	364,-	508,-	648,-	796,-

Badewanne, Stand-Batterien | Bath tub mixer sets, deck mount

	601.40.100 4-Loch Wannenfüll- und Brausebatterie 1/2" für Standmontage <ul style="list-style-type: none"> Ausladung 225 mm; Höhe 180 mm 2 Seitenrandventile mit keramischen Oberteilen 1/2" Metall-Brauseschlauch 2000 mm Metall-Handbrause mit Anti-Kalk-System und Rückflussverhinderer 	Tub/shower mixer set 1/2" deck mount <ul style="list-style-type: none"> spout projection 225 mm; height 180 mm 2 side valves, ceramic internal upper parts 1/2" metal shower hose 2000 mm metal hand shower with anticalc. system and backflow preventer 	A	B	C	D	E
			2.523,-	2.755,-	3.414,-	3.843,-	4.343,-
			F	G	H	I	L
			4.156,-	2.404,-	3.989,-	5.133,-	5.975,-
<hr/>							
Empfohlen Recommended							
	649.40.160 Montageplatte, komplett <ul style="list-style-type: none"> für 4-Loch Armaturen Druckschläuche 1/2" x 1/2" x 600 mm empfohlen: Schlauchkastensystem siehe Kapitel "Serienübergreifendes" 	Assembly plate, complete <ul style="list-style-type: none"> for deck mounted tub/shower mixer pressure hoses 1/2"x 1/2" x 600 mm recommended: system with hose box see chapter "universal products" 	A				
			308,-				

MUSCHEL

Maßzeichnungen unter www.joerger.de - Menü SERVICE.
 Technical specifications under www.joerger.de - menu SERVICE.

A chrom chrome	[.000]	E platin matt platinum matt	[.066]
B silbernickel polished nickel	[.035]	F nerz matt mink matt	[.096]
C nerz mink	[.095]	G schwarz-matt black matt	[.092]
C nickel matt satin nickel	[.036]	G weiß-matt white matt	[.052]
D edelmessing sunshine	[.040]	H bronze bronze	[.011]
D platin platinum	[.065]	I gold gold	[.020]
E edelmess.matt sunshine matt	[.041]	L roségold rosegold	[.022]
E gold matt gold matt	[.021]	L roségold matt rosegold matt	[.023]

	601.40.150 4-Loch Wannenrandkombination 1/2" ■ für Ab- und Überlaufgarnitur mit Wanneneinlauf, ohne Rohrunterbrecher ■ Seitenrandventile, 2-Wege Umstellung ■ Metall-Brauseschlauch 2000 mm ■ Metall-Handbrause mit Anti-Kalk-System und Rückflussverhinderer	tub/shower combination 1/2" ■ for waste and overflow set with bath tub filler spout, without pipe interrupter ■ side valves, 2-position diverter ■ metal shower hose 2000 mm ■ metal hand shower with anticalc. system and backflow preventer	A	B	C	D	E
			1.396,-	1.569,-	1.978,-	2.225,-	2.583,-
			F	G	H	I	L
			2.399,-	1.836,-	2.475,-	3.062,-	3.312,-

Empfohlen | Recommended

	649.40.160 Montageplatte, komplett ■ für 4-Loch Armaturen ■ Druckschläuche 1/2"x1/2" x 600 mm ■ Schlauchkastensystem siehe Kapitel "Serienübergreifendes"	Assembly plate, complete ■ for deck mounted tub/shower mixer ■ pressure hoses 1/2"x1/2" x 600 mm ■ system with hose box see chapter "universal products"	A				
			308,-				

Badewanne, Aufputz-Batterien | Bath tub mixer sets, exposed

	601.20.109 Wannenfüll- und Brausebatterie 1/2" für Aufputzmontage, mit Garnitur ■ Ausladung 145 mm ■ 2 keramische Oberteile 1/2" ■ Metall-Handbrause mit Anti-Kalk-System und Rückflussverhinderer ■ Metall-Brauseschlauch 1.500 mm, beidseitig mit drehbarem Konus	Exposed tub/shower mixer 1/2", incl. shower set ■ spout projection 145 mm ■ 2 ceramic internal upper parts 1/2" ■ metal hand shower with anticalc. system and backflow preventer ■ metal shower hose 1.500 mm, both sides with turning cone	A	B	C	D	E
			825,-	1.299,-	1.815,-	1.879,-	2.286,-
			F	G	H	I	L
			2.105,-	1.911,-	2.199,-	2.478,-	3.602,-

	601.20.149 Wannenfüll- und Brausebatterie für Standrohrmontage, mit Garnitur ■ Ausladung mit Standrohren 182 mm ■ Metall-Handbrause mit Anti-Kalk-System und Rückflussverhinderer ■ Metall-Brauseschlauch 1.500 mm, beidseitig mit drehbarem Konus	Tub/shower mixer for supply pipes, incl. shower set ■ spout projection with pipes 182 mm ■ metal hand shower with anticalc. system and backflow preventer ■ metal shower hose 1.500 mm, both sides with turning cone	A	B	C	D	E
			1.442,-	1.546,-	1.519,-	1.548,-	1.795,-
			F	G	H	I	L
			1.681,-	1.714,-	2.138,-	2.384,-	3.364,-

Benötigt | Required

	109.15.260 Wasserzufuhrstandrohre 1/2" ■ 2 Stück, in Boden einzuschrauben ■ inkl. Winkelstück zum Anschluß der Wannenfüll- und Brausebatterie ■ Höhe 775 - 800 mm	Water supply pipes 1/2" ■ 2 pieces, floor installation ■ incl. angle for connecting tub/shower mixer ■ height 775 - 800 mm	A	B	C	D	E
			888,-	1.282,-	1.672,-	1.882,-	2.219,-
			F	G	H	I	L
			2.095,-	1.632,-	1.952,-	2.525,-	3.488,-

Empfohlen | Recommended

	109.10.970 Bausatz-Vormontage ■ Bodenplatte mit Befestigungsset ■ für Wasserzufuhrstandrohre 600.15.260	Assembly set for pre-installation ■ joint plate with fixing set ■ for water supply pipes 600.15.260	A				
			459,-				

	601.11.100 Wand-Wanneneinlauf 3/4" ■ Ausladung 215 mm ■ Steckanschluß-Montage	Tub wall spout 3/4" ■ spout projection 215 mm ■ special concealed wall attachment	A	B	C	D	E
			742,-	938,-	1.040,-	1.170,-	1.379,-
			F	G	H	I	L
			1.250,-	889,-	1.324,-	1.714,-	1.973,-

Dusche, Aufputz-Batterien | Shower mixer sets, exposed

	601.20.200 Brausebatterie 1/2" für Aufputzmontage ■ 2 keramische Oberteile 1/2" ■ Brauseabgang 3/4" ■ verdeckte S-Anschlüsse 1/2" x 3/4"	Exposed shower mixer 1/2" ■ 2 ceramic internal upper parts 1/2" ■ discharge 3/4" ■ concealed S-connections 1/2" x 3/4"	A	B	C	D	E
			475,-	606,-	704,-	792,-	934,-
			F	G	H	I	L
			879,-	880,-	1.145,-	1.087,-	2.174,-

MUSCHEL

Maßzeichnungen unter www.joerger.de - Menü SERVICE.
 Technical specifications under www.joerger.de - menu SERVICE.

A chrom chrome	[.000]	E platin matt platinum matt	[.066]
B silbernickel polished nickel	[.035]	F nerz matt milk matt	[.096]
C nerz milk	[.095]	G schwarz-matt black matt	[.092]
C nickel matt satin nickel	[.036]	G weiß-matt white matt	[.052]
D edelmessing sunshine	[.040]	H bronze bronze	[.011]
D platin platinum	[.065]	I gold gold	[.020]
E edelmess.matt sunshine matt	[.041]	L roségold rosegold	[.022]
E gold matt gold matt	[.021]	L roségold matt rosegold matt	[.023]

601.20.410 – Aufputz Set mit Steigrohr | Exposed set with shower system

	649.13.920 Regenbrause ½", ø 200 mm <ul style="list-style-type: none"> ■ Ausführung ganz in Metall ■ mit Kugelgelenk ■ Anti-Kalk-System 	Rain shower head ½", ø 200 mm <ul style="list-style-type: none"> ■ full metal body ■ with ball joint ■ with anticalcareous system 	A	B	C	D	E	
				260,-	619,-	824,-	895,-	1.268,-
				F	G	H	I	L
				1.085,-	821,-	1.098,-	1.389,-	2.189,-
	649.20.280 Steigrohr, Umstellung, Wandarm <ul style="list-style-type: none"> ■ zum Anschluß an die Brausebatterie ■ Ausladung 360-380 mm ■ in der Neigung und Höhe verstellbare Brausehalterung 	Supply pipe, diverter, wall bracket <ul style="list-style-type: none"> ■ to connect the exposed shower mixer ■ projection 360-380 mm ■ fitting for handshower adjustable in height and inclination 	A	B	C	D	E	
				589,-	932,-	1.198,-	1.362,-	1.741,-
				F	G	H	I	L
				1.599,-	1.318,-	1.649,-	1.895,-	2.529,-
	600.13.700 Brausegarnitur <ul style="list-style-type: none"> ■ Metall-Handbrause mit Anti-Kalk-System und Rückflussverhinderer ■ Brauseschlauch 1500 mm, beidseitig mit drehbarem Konus 	Shower combination <ul style="list-style-type: none"> ■ metal hand shower with anticalc. system and backflow preventer ■ metal shower hose 1500 mm, both sides with turning cone 	A	B	C	D	E	
				369,-	449,-	551,-	608,-	750,-
				F	G	H	I	L
				695,-	734,-	1.019,-	844,-	1.499,-
601.20.210 Aufputz-Brausebatterie ½" <ul style="list-style-type: none"> ■ für Steigrohr ■ Brauseabgang ¾" 	Exposed shower mixer ½" <ul style="list-style-type: none"> ■ for supply pipe ■ discharge ¾" 	A	B	C	D	E		
			475,-	606,-	704,-	792,-	934,-	
			F	G	H	I	L	
			878,-	878,-	1.145,-	1.087,-	2.172,-	

	601.20.250 Brausethermostat ½" für Aufputzmontage <ul style="list-style-type: none"> ■ Dehnstoff-Thermoelement ■ Sicherheitssperre bei 38° C ■ Keramik-Innenoberteil ½" 	Exposed shower thermostat ½" <ul style="list-style-type: none"> ■ cartridge with thermoelement ■ heat scale, locking device at 38 °C ■ ceramic cartridge ½" 	A	B	C	D	E	
				1.098,-	1.492,-	1.655,-	1.774,-	2.398,-
				F	G	H	I	L
			2.145,-	1.744,-	2.150,-	2.689,-	3.165,-	

601.20.460 – Aufputz Set mit Steigrohr | Exposed set with shower system





	649.13.920 Regenbrause ½", ø 200 mm <ul style="list-style-type: none"> ■ Ausführung ganz in Metall ■ mit Kugelgelenk ■ Anti-Kalk-System 	Rain shower head ½", ø 200 mm <ul style="list-style-type: none"> ■ full metal body ■ with ball joint ■ with anticalcareous system 	A	B	C	D	E	
				260,-	619,-	824,-	895,-	1.268,-
				F	G	H	I	L
				1.085,-	821,-	1.098,-	1.389,-	2.189,-
	649.20.280 Steigrohr, Umstellung, Wandarm <ul style="list-style-type: none"> ■ zum Anschluß an die Brausebatterie ■ Ausladung 375-395 mm ■ in der Neigung und Höhe verstellbare Brausehalterung 	Supply pipe, diverter, wall bracket <ul style="list-style-type: none"> ■ to connect the exposed shower mixer ■ projection 375-395 mm ■ fitting for handshower adjustable in height and inclination 	A	B	C	D	E	
				589,-	932,-	1.198,-	1.362,-	1.741,-
				F	G	H	I	L
				1.599,-	1.318,-	1.649,-	1.895,-	2.529,-
	600.13.700 Brausegarnitur <ul style="list-style-type: none"> ■ Metall-Handbrause mit Anti-Kalk-System und Rückflussverhinderer ■ Brauseschlauch 1500 mm, beidseitig mit drehbarem Konus 	Shower combination <ul style="list-style-type: none"> ■ metal hand shower with anticalc. system and backflow preventer ■ metal shower hose 1500 mm, both sides with turning cone 	A	B	C	D	E	
				369,-	449,-	551,-	608,-	750,-
				F	G	H	I	L
				695,-	734,-	1.019,-	844,-	1.499,-
601.20.260 Aufputz-Brausethermostat ½" <ul style="list-style-type: none"> ■ für Steigrohr ■ Brauseabgang ¾" 	Exposed shower thermostat ½" <ul style="list-style-type: none"> ■ for supply pipe ■ discharge ¾" 	A	B	C	D	E		
			1.146,-	1.540,-	1.704,-	1.822,-	2.446,-	
			F	G	H	I	L	
			2.193,-	1.792,-	2.198,-	2.737,-	3.213,-	

MUSCHEL



Maßzeichnungen unter www.joerger.de - Menü SERVICE.
 Technical specifications under www.joerger.de - menu SERVICE.

A chrom chrome	[.000]	E platin matt platinum matt	[.066]
B silbernickel polished nickel	[.035]	F nerz matt milk matt	[.096]
C nerz milk	[.095]	G schwarz-matt black matt	[.092]
C nickel matt satin nickel	[.036]	G weiß-matt white matt	[.052]
D edelmessing sunshine	[.040]	H bronze bronze	[.011]
D platin platinum	[.065]	I gold gold	[.020]
E edelmess.matt sunshine matt	[.041]	L roségold rosegold	[.022]
E gold matt gold matt	[.021]	L roségold matt rosegold matt	[.023]



Unterputz-Thermostate 1/2" | Wall thermostats, concealed 1/2"

	611.40.380 Unterputz-Thermostat 1/2" mit Mengenregulierung, Fertigmontageset <ul style="list-style-type: none"> manuelle, keramische Umstellung Wanne/Brause, druckunabhängig mit Sicherheitseinrichtung Durchflussrate 20,4 l/min bei 3 bar 	Concealed wall thermostat 1/2" with flow control, assembly set <ul style="list-style-type: none"> manual, ceramic diverter tub/shower for pressure-independent function with safety device flow rate 20,4 l/min at 3 bar 	A	B	C	D	E
			1.078,-	1.297,-	1.534,-	1.573,-	1.871,-
	611.40.360 Unterputz-Thermostat 1/2" mit Mengenregulierung, Fertigmontageset <ul style="list-style-type: none"> ohne Umstellung mit integrierter keramischer Mengenregulierung Durchflussrate 20,4 l/min bei 3 bar 	Concealed wall thermostat 1/2" with flow control, assembly set <ul style="list-style-type: none"> without diverter with integrated ceramic cartridge for volume control flow rate 20,4 l/min at 3 bar 	A	B	C	D	E
			1.043,-	1.241,-	1.477,-	1.516,-	1.815,-
	600.40.460 Unterputz-Thermostat 1/2" ohne Mengenregulierung, Fertigmontageset <ul style="list-style-type: none"> Funktionseinheit ohne Umstellung und ohne Absperrung Durchflussrate 25,8 l/min bei 3 bar 	Concealed wall thermostat 1/2" without flow control, assembly set <ul style="list-style-type: none"> Functional unit without diverter and without shut-off flow rate 25,8 l/min at 3 bar 	A	B	C	D	E
			884,-	984,-	1.246,-	1.276,-	1.548,-
	649.40.360 Unterputz-Einbaubox 1/2" <ul style="list-style-type: none"> zu Fertigmontageset 611.40.360, 611.40.380 und 600.40.460 für Nass- und Trockenbau geeignet 	Concealed wall box 1/2" <ul style="list-style-type: none"> for assembly set 611.40.360, 611.40.380 and 600.40.460 for wetwall and drywall construction 	A				
			168,-				

Unterputz-Thermostat 3/4" | Wall thermostat, concealed 3/4"

	601.40.560 Unterputz-Thermostat 3/4" ohne Mengenregulierung, Fertigmontageset <ul style="list-style-type: none"> serienbezogener Temperiergriff Sicherheitssperre bei 38° C 	Concealed wall thermostat 3/4" without flow control, assembly set <ul style="list-style-type: none"> design handle for temp. control locking device at 38°C 	A	B	C	D	E
			612,-	848,-	1.074,-	1.117,-	1.427,-
	649.40.555 Unterputz-Einbaukörper 3/4" <ul style="list-style-type: none"> zu Fertigmontageset 601.40.555 Kartusche mit Schmutzfangsieben für Nass- und Trockenbau geeignet Durchflussrate 64,2 l/min bei 3 bar ohne Absperrung 	Concealed thermostat body 3/4" <ul style="list-style-type: none"> for assembly set 601.40.555 cartridge with filter screens for wetwall and drywall construction flow rate 64,2 l/min at 3 bar without shut-off 	A				
			1.636,-				

Unterputz-Thermostat 3/4" | Wall thermostat, concealed 3/4"











	601.40.520 Unterputz-Thermostat 3/4" ohne Mengenregulierung, Fertigmontageset <ul style="list-style-type: none"> serienbezogener Temperiergriff Sicherheitssperre bei 38° C 	Concealed wall thermostat 3/4" without flow control, assembly set <ul style="list-style-type: none"> design handle for temp. control locking device at 38°C 	A	B	C	D	E
			612,-	848,-	1.074,-	1.117,-	1.427,-
	649.40.520 Unterputz-Einbaukörper 3/4" <ul style="list-style-type: none"> zu Fertigmontageset 601.40.520 Kartusche mit Schmutzfangsieben für Nass- und Trockenbau geeignet Durchflussrate 41 l/min bei 3 bar ohne Absperrung 	Concealed thermostat body 3/4" <ul style="list-style-type: none"> for assembly set 601.40.520 cartridge with filter screens for wetwall and drywall construction flow rate 41 l/min at 3 bar without shut-off 	A				
			498,-				

MUSCHEL

Maßzeichnungen unter www.joerger.de - Menü SERVICE.
 Technical specifications under www.joerger.de - menu SERVICE.

A chrom chrome	[.000]	E platin matt platinum matt	[.066]
B silbernickel polished nickel	[.035]	F nerz matt milk matt	[.096]
C nerz milk	[.095]	G schwarz-matt black matt	[.092]
C nickel matt satin nickel	[.036]	G weiß-matt white matt	[.052]
D edelmessing sunshine	[.040]	H bronze bronze	[.011]
D platin platinum	[.065]	I gold gold	[.020]
E edelmess.matt sunshine matt	[.041]	L roségold rosegold	[.022]
E gold matt gold matt	[.021]	L roségold matt rosegold matt	[.023]

Unterputz-Thermostat/Ventil-Modul | Concealed thermostatic/wall-valve modul







			A	B	C	D	E
	601.60.432 Unterputz-Ventil-Modul Fertigmontageset <ul style="list-style-type: none"> Griff Rosette 	Concealed wall-valve-modul assembly set <ul style="list-style-type: none"> design handle escutcheon 	258,-	318,-	361,-	406,-	480,-
	Benötigt Required		F	G	H	I	L
			452,-	314,-	461,-	568,-	609,-
	649.20.610 Unterputz-Ventil-Modul, 1-fach <ul style="list-style-type: none"> 1x Spindelventil 3/4", rechtsschließend mit keram. Scheiben 2 Abgänge 1/2", je 1x rechts/links möglich, gleichzeitig benutzbar 	Concealed wall-valve-modul, single <ul style="list-style-type: none"> 1x spindle valve 3/4", clockwise closure with ceramic discs 2 outlets 1/2", each 1x right/left possible, simultaneously usable 	A				
			229,-				
	649.20.620 Unterputz-Ventil-Modul, 2-fach <ul style="list-style-type: none"> 2x Spindelventil 3/4", rechtsschließend mit keram. Scheiben 4 Abgänge 1/2", je 2x rechts/links möglich, gleichzeitig benutzbar im Verbund maßgenaue Montage erweiterbar mit 649.20.610 	Concealed wall-valve-modul, double <ul style="list-style-type: none"> 2x spindle valve 3/4", clockwise closure with ceramic discs 4 outlets 1/2", each 2x right/left possible, simultaneously usable precise assembly due to composite expandable with 649.20.610 	A				
			458,-				
	649.20.630 Unterputz-Ventil-Modul, 3-fach <ul style="list-style-type: none"> 3x Spindelventil 3/4", rechtsschließend mit keram. Scheiben 6 Abgänge 1/2", je 3x rechts/links möglich, gleichzeitig benutzbar im Verbund maßgenauen Montage erweiterbar mit 649.20.610 	Concealed wall-valve-modul, triple <ul style="list-style-type: none"> 3x spindle valve 3/4", clockwise closure with ceramic discs 6 outlets 1/2", each 3x right/left possible, simultaneously usable precise assembly due to composite expandable with 649.20.610 	A				
			686,-				
	600.40.460 Unterputz-Thermostat 1/2" ohne Mengenregulierung, Fertigmontageset <ul style="list-style-type: none"> Funktionseinheit ohne Umstellung und ohne Absperrung Durchflussrate 25,8 l/min bei 3 bar 	Concealed wall thermostat 1/2" without flow control, assembly set <ul style="list-style-type: none"> Functional unit without diverter and without shut-off flow rate 25,8 l/min at 3 bar 	A	B	C	D	E
			884,-	984,-	1.246,-	1.276,-	1.548,-
			F	G	H	I	L
		1.431,-	1.051,-	1.488,-	1.707,-	1.919,-	
Benötigt Required		A					
	649.20.612 Anschlußadapter 1/2" <ul style="list-style-type: none"> Anschlußadapter, Abschlußstopfen passend zu Einbaubox 649.40.360 	Connection adapter 1/2" <ul style="list-style-type: none"> connection adapter, end plug matching to wall box 649.40.360 	122,-				
	649.40.360 Unterputz-Einbaubox 1/2" <ul style="list-style-type: none"> zu Fertigmontageset 600.40.460 für Nass- und Trockenbau geeignet 	Concealed wall box 1/2" <ul style="list-style-type: none"> for assembly set 600.40.460 for wetwall and drywall construction 	A				
			168,-				
	601.40.560 Unterputz-Thermostat 3/4" ohne Mengenregulierung, Fertigmontageset <ul style="list-style-type: none"> serienbezogener Temperiergriff Sicherheitsperre bei 38° C 	Concealed wall thermostat 3/4" without flow control, assembly set <ul style="list-style-type: none"> design handle for temp. control locking device at 38° C 	A	B	C	D	E
			612,-	848,-	1.074,-	1.117,-	1.427,-
			F	G	H	I	L
		1.304,-	719,-	1.389,-	1.664,-	1.965,-	
Benötigt Required		A					
	649.20.634 Anschlußadapter 3/4" <ul style="list-style-type: none"> Anschlußadapter, Abschlußstopfen passend zu Einbaukörper 649.40.555 	Connection adapter 3/4" <ul style="list-style-type: none"> connection adapter, end plug matching to wall body 649.40.555 	146,-				
	649.40.555 Unterputz-Einbaukörper 3/4" <ul style="list-style-type: none"> zu Fertigmontageset 601.40.555 Kartusche mit Schmutzfangsieben für Nass- und Trockenbau geeignet Durchflussrate 64,2 l/min bei 3 bar ohne Absperrung 	Concealed thermostat body 3/4" <ul style="list-style-type: none"> for assembly set 601.40.555 cartridge with filter screens for wetwall and drywall construction flow rate 64,2 l/min at 3 bar without shut-off 	A				
			1.636,-				

MUSCHEL



Maßzeichnungen unter www.joerger.de - Menü SERVICE.
 Technical specifications under www.joerger.de - menu SERVICE.

A chrom chrome	[.000]	E platin matt platinum matt	[.066]
B silbernickel polished nickel	[.035]	F nerz matt mink matt	[.096]
C nerz mink	[.095]	G schwarz-matt black matt	[.092]
C nickel matt satin nickel	[.036]	G weiß-matt white matt	[.052]
D edelmessing sunshine	[.040]	H bronze bronze	[.011]
D platin platinum	[.065]	I gold gold	[.020]
E edelmess.matt sunshine matt	[.041]	L roségold rosegold	[.022]
E gold matt gold matt	[.021]	L roségold matt rosegold matt	[.023]

Unterputz-Umstellung und Ventile | Diverter and valves concealed

			A	B	C	D	E
	601.40.650 Unterputz 3-Wege Umstellung ½" Fertigmontageset ■ Griff ■ Hülse, Schubrosette	Concealed 3-position diverter ½" assembly set ■ design handle ■ socket with adjustable escutcheon	258,-	318,-	361,-	406,-	480,-
			450,-	322,-	461,-	568,-	616,-
			Benötigt Required				
	649.40.600 Unterputz 3-Wege Umstellung ½" Einbaukörper ■ zu Fertigmontageset 601.40.650	Concealed 3-position diverter ½" diverter body ■ for assembly set 601.40.650	236,-				
			Benötigt Required				
	601.50.234 Unterputz-Ventil Fertigmontageset ■ Griff ■ Hülse, Schubrosette	Concealed wall valve assembly set ■ design handle ■ socket with adjustable escutcheon	212,-	263,-	298,-	334,-	394,-
			366,-	335,-	428,-	467,-	628,-
			Benötigt Required				
	649.20.340 Unterputz-Ventil ½", Einbaukörper ■ rechtsschließend, ker. Scheiben	Concealed wall valve ½", body ■ clockwise closure, ceramic discs	62,-				
			Benötigt Required				
	649.20.345 Unterputz-Ventil ½", Einbaukörper ■ linksschließend, ker. Scheiben	Concealed wall valve ½", body ■ counter-clockwise closure, cer. discs					
			Benötigt Required				
	649.20.440 Unterputz-Ventil ¾", Einbaukörper ■ rechtsschließend, ker. Scheiben	Concealed wall valve ¾", body ■ clockwise closure, ceramic discs	106,-				
			Benötigt Required				
	649.20.445 Unterputz-Ventil ¾", Einbaukörper ■ linksschließend, ker. Scheiben	Concealed wall valve ¾", body ■ counter-clockwise closure, cer. discs					
			Benötigt Required				



Brausen | Showers

			A	B	C	D	E
	601.13.310 Duschgarnitur, komplett ■ Wandrohr 780 mm, mit Schieber ■ Metall-Handbrause mit Anti-Kalk-System und Rückflussverhinderer ■ Metall-Brauseschlauch 1750 mm, beidseitig mit drehbarem Konus	Shower bar set, complete ■ wall bar 780 mm, with slider ■ metal hand shower with anticalc. system and backflow preventer ■ metal shower hose 1750 mm, both sides with turning cone	1.412,-	1.624,-	1.678,-	1.764,-	2.112,-
			1.945,-	1.873,-	2.314,-	2.398,-	3.638,-
			Benötigt Required				
	601.13.350 Duschstange, lose ■ Wandrohr 780 mm, mit Schieber	Shower bar, separate ■ wall bar 780 mm, with slider	1.038,-	1.164,-	1.182,-	1.273,-	1.500,-
			1.347,-	1.155,-	1.826,-	1.776,-	2.262,-
			Benötigt Required				
	601.13.200 Schlauchbrausegarnitur ■ Wandanschlußbogen ½" ■ Wand-Brausehalter ■ Metall-Handbrause mit Anti-Kalk-System und Rückflussverhinderer ■ Metall-Brauseschlauch 1500 mm, beidseitig mit drehbarem Konus	Shower combination ■ Wall elbow connection ½" ■ Wall fitting for hand shower ■ metal hand shower with anticalc. system and backflow preventer ■ flexible metal shower hose 1500 mm, both sides with turning cone	535,-	698,-	921,-	1.037,-	1.221,-
			1.162,-	948,-	1.252,-	1.363,-	1.784,-
			Benötigt Required				

MUSCHEL

Maßzeichnungen unter www.joerger.de - Menü SERVICE.
 Technical specifications under www.joerger.de - menu SERVICE.

A chrom chrome	[.000]	E platin matt platinum matt	[.066]
B silbernickel polished nickel	[.035]	F nerz matt mink matt	[.096]
C nerz mink	[.095]	G schwarz-matt black matt	[.092]
C nickel matt satin nickel	[.036]	G weiß-matt white matt	[.052]
D edelmessing sunshine	[.040]	H bronze bronze	[.011]
D platin platinum	[.065]	I gold gold	[.020]
E edelmess.matt sunshine matt	[.041]	L roségold rosegold	[.022]
E gold matt gold matt	[.021]	L roségold matt rosegold matt	[.023]



	601.13.150 Wandanschlußbogen ½“, ohne Haken <ul style="list-style-type: none"> ■ Brauseabgang ½“ ■ mit Rückflussverhinderer, Rosette 	Wall elbow connection ½“, without cradle <ul style="list-style-type: none"> ■ discharge ½“ ■ with backflow preventer, escutcheon 	A	B	C	D	E
			99,-	118,-	129,-	134,-	158,-
			F	G	H	I	L
			147,-	158,-	198,-	183,-	313,-
	649.13.210 Wand-Brausehalter	Wall fitting for hand shower	A	B	C	D	E
			178,-	214,-	266,-	287,-	337,-
			F	G	H	I	L
			299,-	256,-	325,-	374,-	459,-
	601.13.237 Hygienebrausegarnitur <ul style="list-style-type: none"> ■ Wandbrausehalter und -anschlußbogen ½“, Schubrossette ■ Hygienebrause, klassisch (649.13.338), komplett aus Metall ■ einstrahlig, Bedienung über Druckhebel ■ Metall-Brauseschlauch 1250 mm 	Ablution spray combination <ul style="list-style-type: none"> ■ wall fitting and elbow connection ½“ ■ spray handshower, classical (649.13.338), completely metal ■ one jet, push-lever operation ■ flexible metal shower hose 1250 mm 	A	B	C	D	E
			301,-	373,-	612,-	641,-	859,-
			F	G	H	I	L
			737,-	671,-	998,-	1.101,-	1.529,-
	607.20.237 1-Hand Batterie ½“ für Hygiene-Brause, Fertigmontageset <ul style="list-style-type: none"> ■ Rosette, Griff ■ mit Hebelgriff 	Concealed single lever ½“ for ablution spray, assembly set <ul style="list-style-type: none"> ■ escutcheon, handle ■ with lever handle 	A	B	C	D	E
			296,-	378,-	490,-	552,-	649,-
			F	G	H	I	L
			594,-	534,-	612,-	754,-	811,-
	Benötigt Required 649.20.237 Unterputz 1-Hand Batterie ½“, Einbaukörper <ul style="list-style-type: none"> ■ Kartusche mit keramischen Scheiben ■ zu Fertigmontageset 601.20.237 	Single lever mixer ½“, concealed body <ul style="list-style-type: none"> ■ cartridge with ceramic discs ■ for assembly set 601.20.237 	A	B	C	D	E
			125,-	169,-	208,-	229,-	268,-
			F	G	H	I	L
			249,-	224,-	258,-	329,-	396,-
	649.13.615 Stachelkopfbrause ½“ <ul style="list-style-type: none"> ■ ø 230 mm, 75 Düsen ■ Ausführung ganz in Metall ■ Anti-Kalk-System ■ Brausekopf schwenkbar ■ ohne Wandarm 	Body spray shower head ½“ <ul style="list-style-type: none"> ■ ø 230 mm, 75 jets ■ full metal body ■ anticalcareous system ■ swivel shower head ■ without wall bracket 	A	B	C	D	E
			969,-	1.232,-	1.359,-	1.416,-	1.659,-
			F	G	H	I	L
			1.496,-	1.399,-	1.718,-	2.262,-	2.739,-
	<ul style="list-style-type: none"> ■ weitere, zur Serie passende Kopfbrausen siehe Kapitel “Brausen” 	<ul style="list-style-type: none"> ■ for further shower heads matching this collection see chapter “showers” 	A	B	C	D	E
			126,-	145,-	171,-	189,-	250,-
			F	G	H	I	L
			229,-	192,-	296,-	286,-	499,-
	649.13.519 Seitenbrause ½“ <ul style="list-style-type: none"> ■ Rosette ø 130 mm, Wandmontage ■ Brausekopf schwenkbar, 20° ■ Anti-Kalk-System ■ Ausführung Kunststoff 	Body spray side shower ½“ <ul style="list-style-type: none"> ■ escutcheon ø 130 mm, wall assembly ■ swivel shower head, 20° ■ anticalcareous system ■ plastic 	A	B	C	D	E
			167,-	326,-	385,-	399,-	542,-
			F	G	H	I	L
			496,-	376,-	472,-	634,-	949,-
<ul style="list-style-type: none"> ■ weitere, zur Serie passende Seitenbrausen siehe Kapitel “Brausen” ■ for further side showers matching this collection see chapter “showers” 							

MUSCHEL

A chrom chrome	[.000]	E platin matt platinum matt	[.066]
B silbernickel polished nickel	[.035]	F nerz matt mink matt	[.096]
C nerz mink	[.095]	G schwarz-matt black matt	[.092]
C nickel matt satin nickel	[.036]	G weiß-matt white matt	[.052]
D edelmessing sunshine	[.040]	H bronze bronze	[.011]
D platin platinum	[.065]	I gold gold	[.020]
E edelmess.matt sunshine matt	[.041]	L roségold rosegold	[.022]
E gold matt gold matt	[.021]	L roségold matt rosegold matt	[.023]

Maßzeichnungen unter www.joerger.de - Menü SERVICE.
 Technical specifications under www.joerger.de - menu SERVICE.

Accessoires für Handtücher | Accessories for towels

	601.00.002 Handtuchhalter, doppelt ■ Rohre schwenkbar, ca. 430 mm	Double towel bar ■ swivelling bars, approx. 430 mm	A	B	C	D	E
			512,-	594,-	616,-	654,-	802,-
	601.00.012 Handtuchhalter, doppelt ■ verkürzt, ca. 300 mm	Double towel bar ■ shortened, approx. 300 mm	F	G	H	I	L
			717,-	662,-	769,-	984,-	1.253,-

	601.00.047 Handtuchring ■ ø ca. 190 mm ■ geschlossene Ausführung	Towel ring ■ ø approx. 190 mm ■ closed version	A	B	C	D	E
			444,-	488,-	489,-	535,-	650,-
			F	G	H	I	L
			550,-	528,-	594,-	765,-	950,-

	601.00.022 Handtuchhaken	Robe hanger	A	B	C	D	E
			230,-	276,-	357,-	409,-	492,-
			F	G	H	I	L
			457,-	375,-	494,-	598,-	685,-

	601.00.040 Badetuchhalter ■ ca. 800 mm	Bath towel bar ■ approx. 800 mm	A	B	C	D	E
			882,-	1.014,-	1.048,-	1.085,-	1.319,-
			F	G	H	I	L
			1.215,-	912,-	1.146,-	1.429,-	1.962,-

	601.00.031 Wannengriff ■ ca. 330 mm	Tub handle ■ approx. 330 mm	A	B	C	D	E
			792,-	874,-	886,-	898,-	1.062,-
			F	G	H	I	L
			988,-	818,-	912,-	1.139,-	1.368,-

	601.00.104 Gästehandtuchkorb, eckig ■ mit Ablage ■ Korbgröße 260 x 150 x 190 mm	Guest towel basket, angular ■ with shelf ■ basket size 260 x 150 x 190 mm	A	B	C	D	E
			428,-	566,-	636,-	692,-	835,-
			F	G	H	I	L
			759,-	642,-	1.052,-	915,-	1.958,-

Accessoires für Waschplatz | Accessories for washstands

	601.00.007 Seifenhalter, komplett ■ Seifenschale aus Kristallglas	Soap dish holder, complete ■ crystal glass dish	A	B	C	D	E
			347,-	398,-	538,-	605,-	734,-
			F	G	H	I	L
			677,-	419,-	615,-	890,-	954,-

701.00.307 Seifenschale, lose	Glass dish, separate	A				
		89,-				

MUSCHEL

Maßzeichnungen unter www.joerger.de - Menü SERVICE.
 Technical specifications under www.joerger.de - menu SERVICE.

A chrom chrome	[.000]	E platin matt platinum matt	[.066]
B silbernickel polished nickel	[.035]	F nerz matt milk matt	[.096]
C nerz milk	[.095]	G schwarz-matt black matt	[.092]
C nickel matt satin nickel	[.036]	G weiß-matt white matt	[.052]
D edelmessing sunshine	[.040]	H bronze bronze	[.011]
D platin platinum	[.065]	I gold gold	[.020]
E edelmess.matt sunshine matt	[.041]	L roségold rosegold	[.022]
E gold matt gold matt	[.021]	L roségold matt rosegold matt	[.023]

	601.00.105 Schwammkorb ■ rechteckig, 260 x 130 mm	Sponge basket ■ rectangular, 260 x 130 mm	A	B	C	D	E
			439,-	536,-	604,-	636,-	809,-
			F	G	H	I	L
			748,-	616,-	798,-	889,-	1.306,-

	601.00.106 Eckschwammkorb ■ 195 x 195 mm	Corner sponge basket ■ 195 x 195 mm	A	B	C	D	E
			351,-	529,-	568,-	589,-	729,-
			F	G	H	I	L
			668,-	626,-	736,-	863,-	1.228,-

	601.00.006 Lotionspender, komplett	Soap dispenser, complete	A	B	C	D	E
			546,-	588,-	598,-	612,-	750,-
			F	G	H	I	L
			641,-	597,-	658,-	908,-	985,-

	713.00.306 Lotionspenderglas, lose ■ seidenmatt, ohne Pumpe	Soap dispenser glass, separate ■ frosted, without pump	A				
			78,-				

	601.00.036 Glashalter, komplett ■ Glas aus Kristallglas	Tumbler holder, complete ■ crystal glass tumbler	A	B	C	D	E
			446,-	468,-	576,-	648,-	794,-
			F	G	H	I	L
			743,-	477,-	666,-	963,-	1.062,-

	700.00.336 Mundglas, lose	Glass tumbler, separate	A				
			96,-				

	601.00.009 Ablage, 600 mm ■ Glasplatte aus Kristallglas	Shelf holder with glass, 600 mm ■ crystal glass shelf	A	B	C	D	E
			765,-	816,-	839,-	854,-	942,-
			F	G	H	I	L
			882,-	862,-	826,-	1.138,-	1.209,-

Accessoires für WC-Bereich | Accessories for w.c. area



	601.00.014 Papierhalter ■ mit Deckel	Toilet paper roll holder ■ with lid	A	B	C	D	E
			448,-	464,-	707,-	796,-	976,-
			F	G	H	I	L
			859,-	526,-	859,-	1.195,-	1.276,-

	601.00.015 Reserve-Papierhalter	Spare toilet paper roll holder	A	B	C	D	E
			428,-	456,-	486,-	546,-	663,-
			F	G	H	I	L
			593,-	432,-	561,-	805,-	866,-



MUSCHEL

Maßzeichnungen unter www.joerger.de - Menü SERVICE.
 Technical specifications under www.joerger.de - menu SERVICE.

A chrom chrome	[.000]	E platin matt platinum matt	[.066]
B silbernickel polished nickel	[.035]	F nerz matt mink matt	[.096]
C nerz mink	[.095]	G schwarz-matt black matt	[.092]
C nickel matt satin nickel	[.036]	G weiß-matt white matt	[.052]
D edelmessing sunshine	[.040]	H bronze bronze	[.011]
D platin platinum	[.065]	I gold gold	[.020]
E edelmess.matt sunshine matt	[.041]	L roségold rosegold	[.022]
E gold matt gold matt	[.021]	L roségold matt rosegold matt	[.023]

	601.00.000 Klosettbürstengarnitur, komplett ■ Glas aus Kristallglas, seidenmatt	Toilet brush holder set, complete ■ crystal glass, frosted	A	B	C	D	E
			658,-	742,-	756,-	779,-	935,-
			F	G	H	I	L
			865,-	715,-	918,-	1.080,-	1.250,-
	799.00.300 Bürstenglas, seidenmatt, lose	Brush glass, frosted, separate	A				
			48,-				
	651.00.053 Bürstenstange komplett, lose	Brush rod with brush, separate	A	B	C	D	E
			121,-	148,-	176,-	197,-	232,-
			F	G	H	I	L
			215,-	167,-	214,-	280,-	369,-
	799.00.224 Bürstenkopf, lose	Brush, separate	A				
			19,-				

Leuchten und Spiegel | Lamps and mirrors

	601.00.061 Wandleuchte, komplett ■ mit Leuchtmittel, 40 W	Wall lamp, complete ■ light bulb included, 40 W	A	B	C	D	E
			592,-	758,-	831,-	934,-	1.100,-
			F	G	H	I	L
			1.040,-	918,-	996,-	1.205,-	1.756,-
	701.00.361 Leuchtenglas, lose ■ Leuchtenglas klar	Glass, separate ■ glass clear	A				
			282,-				
	649.00.414 Kosmetikspiegel, beleuchtet ■ schwenk- und ausziehbar ■ 3-fache Vergrößerung ■ Direktanschluss ■ Spiegeldurchmesser 185 mm ■ Rahmendurchmesser 250 mm ■ Kalt-, Warm- und Taglicht durch Piezzo-Schalter umschaltbar	Cosmetic mirror, incl. lighting ■ swivelling and extendable ■ magnification 3:1 ■ direct connection ■ mirror diameter 185 mm ■ frame diameter 250 mm ■ cold, warm and day light switchable by Piezzo switch	A	B	C	D	E
			556,-	988,-	1.214,-	1.418,-	1.828,-
			F	G	H	I	L
			1.684,-	1.214,-	1.549,-	2.138,-	2.998,-



Oberflächen | colours

Folgende Oberflächen sind bei dieser Serie möglich |
The following colours are possible with this collection

chrom	chrome	[.000] PG A
silbernickel	polished nickel	[.035] PG B
nerz	mink	[.095] PG C
nickel matt	satin nickel	[.036] PG C
edelmessing	sunshine	[.040] PG D
platin	platinum	[.065] PG D
edelmessing matt	sunshine matt	[.041] PG E
gold matt	gold matt	[.021] PG E
platin matt	platinum matt	[.066] PG E
nerz matt	mink matt	[.096] PG F
schwarz matt	black matt	[.092] PG G
weiß matt	white matt	[.052] PG G
bronze	bronze	[.011] PG H
gold	gold	[.020] PG I
roségold	rosegold	[.022] PG L
roségold matt	rosegold matt	[.023] PG L

Andere Oberflächen auf Anfrage |
Different colours on request

Auf Anfrage können wir Produkte von Drittanbietern auch gerne passend zu unseren Oberflächen veredeln (vorbehaltlich der Eignungsprüfung) | Third-party products may be plated matching to our colours on request (subject to valuation of suitability)

Waschtisch | Washbasin

ab Seite | from page 344

Bidet | Bidet

ab Seite | from page 344

Wanne | Bath tub

ab Seite | from page 345

Dusche | Shower

ab Seite | from page 346

Accessoires | Accessories

ab Seite | from page 353

RAMSES | ALBANO

Maßzeichnungen unter www.joerger.de - Menü SERVICE.
 Technical specifications under www.joerger.de - menu SERVICE.

A chrom chrome	[.000]	E platin matt platinum matt	[.066]
B silbernickel polished nickel	[.035]	F nerz matt milk matt	[.096]
C nerz milk	[.095]	G schwarz-matt black matt	[.092]
C nickel matt satin nickel	[.036]	G weiß-matt white matt	[.052]
D edelmessing sunshine	[.040]	H bronze bronze	[.011]
D platin platinum	[.065]	I gold gold	[.020]
E edelmess.matt sunshine matt	[.041]	L roségold rosegold	[.022]
E gold matt gold matt	[.021]	L roségold matt rosegold matt	[.023]

Waschtisch Batterien | Washbasin mixer



- 611.30.300** Waschtisch 3-Loch Batterie ½"
- Designvariante RAMSES
 - Ausladung 130 mm; Höhe 165 mm
 - Exzenter-Ablaufgarnitur 1 ¼"
 - empfohlen:
2x 649.15.530 - Kupferrohr 300 mm

- Washbasin 3-hole mixer ½"**
- design style RAMSES
 - spout projection 130 mm; height 165 mm
 - pop-up waste 1 ¼"
 - recommended:
2x 649.15.530 - copper tube 300 mm

A	B	C	D	E
1.139,-	1.519,-	1.605,-	1.806,-	2.126,-
F	G	H	I	L
2.013,-	1.793,-	2.074,-	2.443,-	3.517,-

Griffvariante | Handle alternative



- 608.30.300** Waschtisch 3-Loch Batterie ½"
- Designvariante ALBANO

- Washbasin 3-hole mixer ½"**
- design style ALBANO



- 611.10.300** Waschtisch 1-Loch Batterie ½"
- Ausladung 125 mm; Höhe 165 mm
 - Keramik-Innenoberteile ½"
 - Exzenter-Ablaufgarnitur 1 ¼"
 - 2 Kupferrohre M10x1 x 400 mm

- Washbasin 1-hole mixer ½"**
- spout projection 125 mm; height 165 mm
 - ceramic internal upper parts ½"
 - pop-up waste 1 ¼"
 - 2 copper tubes M10x1 x 400 mm

A	B	C	D	E
878,-	1.088,-	1.331,-	1.503,-	1.769,-
F	G	H	I	L
1.667,-	1.312,-	1.497,-	2.098,-	2.664,-



- 604.10.400** Standventil ½"
- Ausladung 95 mm; Höhe 85 mm
 - starrer Auslauf
 - Fettkammer-Innenoberteil ½"

- Deck mount tap ½"**
- spout projection 95 mm; height 85 mm
 - rigid spout
 - cartridge ½"

A	B	C	D	E
209,-	274,-	292,-	312,-	418,-
F	G	H	I	L
372,-	644,-	668,-	465,-	876,-



- 611.10.500** Wand-Auslaufventil ½"
- Ausladung 100 mm
 - Fettkammer-Innenoberteil ½"

- Wall tap ½"**
- spout projection 100 mm
 - cartridge ½"

A	B	C	D	E
259,-	357,-	376,-	423,-	500,-
F	G	H	I	L
472,-	670,-	534,-	585,-	862,-

Bidet Batterien | Bidet mixer



- 611.30.100** Bidet 3-Loch Batterie ½"
- Designvariante RAMSES
 - Ausladung 105 mm; Höhe 104 mm
 - Exzenter-Ablaufgarnitur 1 ¼"
 - empfohlen:
2x 649.15.530 - Kupferrohr 300 mm

- Bidet 3-hole mixer ½"**
- design style RAMSES
 - spout projection 105 mm; height 104 mm
 - pop-up waste 1 ¼"
 - recommended:
2x 649.15.530 - copper tube 300 mm

A	B	C	D	E
1.297,-	1.774,-	1.856,-	2.089,-	2.458,-
F	G	H	I	L
2.276,-	1.811,-	2.249,-	2.711,-	3.484,-

Griffvariante | Handle alternative



- 608.30.100** Bidet 3-Loch Batterie ½"
- Designvariante ALBANO

- Bidet 3-hole mixer ½"**
- design style ALBANO



- 611.10.100** Bidet 1-Loch Batterie ½"
- Ausladung 110 mm; Höhe 112 mm
 - Keramik-Innenoberteile ½"
 - Exzenter-Ablaufgarnitur 1 ¼"
 - 2 Kupferrohre M10x1 x 400 mm

- Bidet 1-hole mixer ½"**
- spout projection 110 mm; height 112 mm
 - ceramic internal upper parts ½"
 - pop-up waste 1 ¼"
 - 2 copper tubes M10x1 x 400 mm

A	B	C	D	E
1.061,-	1.305,-	1.519,-	1.709,-	2.013,-
F	G	H	I	L
1.941,-	1.007,-	1.731,-	2.334,-	2.426,-

RAMSES | ALBANO

Maßzeichnungen unter www.joerger.de - Menü SERVICE.
 Technical specifications under www.joerger.de - menu SERVICE.

A chrom chrome	[.000]	E platin matt platinum matt	[.066]
B silbernickel polished nickel	[.035]	F nerz matt milk matt	[.096]
C nerz milk	[.095]	G schwarz-matt black matt	[.092]
C nickel matt satin nickel	[.036]	G weiß-matt white matt	[.052]
D edelmessing sunshine	[.040]	H bronze bronze	[.011]
D platin platinum	[.065]	I gold gold	[.020]
E edelmess.matt sunshine matt	[.041]	L roségold rosegold	[.022]
E gold matt gold matt	[.021]	L roségold matt rosegold matt	[.023]

Zubehör für Waschtisch- und Bidet-Batterien | Supplies for washbasin and bidet mixer

	611.12.100 Eckventil 1/2" <ul style="list-style-type: none"> ■ Designvariante RAMSES ■ Ausladung 116 mm ■ Fettkammer-Innenoberteil 1/2" ■ Quetschverschraubung 	Angle valve 1/2" <ul style="list-style-type: none"> ■ design style RAMSES ■ projection 116 mm ■ cartridge 1/2" ■ compression joint 	A	B	C	D	E	
				296,-	362,-	373,-	397,-	467,-
				F	G	H	I	L

Griffvariante | Handle alternative

	608.12.100 Eckventil 1/2" <ul style="list-style-type: none"> ■ Designvariante ALBANO ■ Ausladung 120 mm 	Angle valve 1/2" <ul style="list-style-type: none"> ■ design style ALBANO ■ projection 120 mm 	A	B	C	D	E	
				436,-	377,-	544,-	543,-	787,-
				F	G	H	I	L

	649.15.530 Kupferrohr, 300 mm <ul style="list-style-type: none"> ■ mit Bördel, für Quetschverschraubung 	Copper tube, 300 mm <ul style="list-style-type: none"> ■ with flange, for compression joint 	A	B	C	D	E	
				15,-	38,-	55,-	62,-	74,-
				F	G	H	I	L

Variante | Alternative

	649.15.550 Kupferrohr, 500 mm <ul style="list-style-type: none"> ■ mit Bördel, für Quetschverschraubung 	Copper tube, 500 mm <ul style="list-style-type: none"> ■ with flange, for compression joint 	A	B	C	D	E	
				20,-	58,-	77,-	87,-	102,-
				F	G	H	I	L

	649.15.340 Waschtisch-Tassensiphon 1 1/4" <ul style="list-style-type: none"> ■ schwere Ausführung ■ Rosette ■ Abgangsrohr ø 32 mm ■ Tauchrohrlänge 165 mm 	Washbasin cupped siphon trap 1 1/4" <ul style="list-style-type: none"> ■ heavy brass ■ escutcheon ■ outlet tube ø 32 mm ■ dip pipe 165 mm 	A	B	C	D	E	
				195,-	296,-	368,-	429,-	568,-
				F	G	H	I	L

	649.15.330 Bidet-Tassensiphon 1 1/4" <ul style="list-style-type: none"> ■ Rosette ■ Abgangsrohr ø 32 mm 	Bidet cupped siphon trap 1 1/4" <ul style="list-style-type: none"> ■ escutcheon ■ outlet tube ø 32 mm 	A	B	C	D	E	
				98,-	166,-	276,-	332,-	472,-
				F	G	H	I	L

Badewanne, Stand-Batterien | Bath tub mixer sets, deck mount

	611.40.100 4-Loch Stand-Wannenfüll- u. Brausebatterie 1/2" – RAMSES <ul style="list-style-type: none"> ■ Ausladung 220 mm; Höhe 188 mm ■ 2 Seitenrandventile mit ker. Oberteilen 1/2" ■ Metall-Brauseschlauch 2000 mm ■ Metall-Handbrause mit Anti-Kalk-System und Rückflussverhinderer 	Tub/shower mixer set 1/2" deck mount – RAMSES <ul style="list-style-type: none"> ■ spout projection 220 mm; height 188 mm ■ 2 side valves, cer. internal upper parts 1/2" ■ metal shower hose 2000 mm ■ metal hand shower with anticalc. system and backflow preventer 	A	B	C	D	E	
				2.299,-	2.487,-	3.004,-	3.381,-	3.664,-
				F	G	H	I	L

Griffvariante | Handle alternative

	608.40.100 4-Loch Stand-Wannenfüll- u. Brausebatterie 1/2" – ALBANO	Tub/shower mixer set 1/2" deck mount – ALBANO	A	B	C	D	E	
				3.515,-	2.579,-	3.581,-	4.408,-	4.979,-
				F	G	H	I	L



Empfohlen | Recommended

	649.40.160 Montageplatte, komplett <ul style="list-style-type: none"> ■ für 4-Loch Armaturen ■ Druckschläuche 1/2" x 1/2" x 600 mm ■ empfohlen: Schlauchkastensystem siehe Kapitel "Serienübergreifendes" 	Assembly plate, complete <ul style="list-style-type: none"> ■ for deck mounted tub/shower mixer ■ pressure hoses 1/2" x 1/2" x 600 mm ■ recommended: system with hose box see chapter "universal products" 	A					
				308,-				
				F	G	H	I	L

RAMSES | ALBANO

Maßzeichnungen unter www.joerger.de - Menü SERVICE.
 Technical specifications under www.joerger.de - menu SERVICE.

A chrom chrome	[.000]	E platin matt platinum matt	[.066]
B silbernickel polished nickel	[.035]	F nerz matt mink matt	[.096]
C nerz mink	[.095]	G schwarz-matt black matt	[.092]
C nickel matt satin nickel	[.036]	G weiß-matt white matt	[.052]
D edelmessing sunshine	[.040]	H bronze bronze	[.011]
D platin platinum	[.065]	I gold gold	[.020]
E edelmess.matt sunshine matt	[.041]	L roségold rosegold	[.022]
E gold matt gold matt	[.021]	L roségold matt rosegold matt	[.023]



	611.40.150 4-Loch Wannenrand-kombination 1/2" – RAMSES <ul style="list-style-type: none"> für Ab- und Überlaufgarnitur mit Wanneneinlauf, ohne Rohrunterbrecher Seitenrandventile, 2-Wege Umstellung Metall-Brauseschlauch 2000 mm Metall-Handbrause mit Anti-Kalk-System und Rückflussverhinderer empfohlen: 2x 649.15.530 - Kupferrohr 300 mm 	tub/shower combination 1/2" <ul style="list-style-type: none"> design style RAMSES for waste and overflow set with bath tub filler spout, without pipe interrupter side valves, 2-position diverter metal shower hose 2000 mm metal hand shower with anticalc. system and backflow preventer recommended: 2x 649.15.530 - copper tube 300 mm 	<table border="1"> <tr><th>A</th><th>B</th><th>C</th><th>D</th><th>E</th></tr> <tr><td>1.778,-</td><td>1.994,-</td><td>2.164,-</td><td>2.436,-</td><td>2.829,-</td></tr> <tr><th>F</th><th>G</th><th>H</th><th>I</th><th>L</th></tr> <tr><td>2.637,-</td><td>2.185,-</td><td>2.712,-</td><td>3.358,-</td><td>3.633,-</td></tr> </table>	A	B	C	D	E	1.778,-	1.994,-	2.164,-	2.436,-	2.829,-	F	G	H	I	L	2.637,-	2.185,-	2.712,-	3.358,-	3.633,-
	A	B	C	D	E																		
	1.778,-	1.994,-	2.164,-	2.436,-	2.829,-																		
F	G	H	I	L																			
2.637,-	2.185,-	2.712,-	3.358,-	3.633,-																			
Griffvariante Handle alternative																							
	608.40.150 4-Loch Wannenrand-kombination 1/2" – ALBANO <ul style="list-style-type: none"> design style ALBANO 	tub/shower combination 1/2" <ul style="list-style-type: none"> design style ALBANO 	<table border="1"> <tr><th>A</th><th>B</th><th>C</th><th>D</th><th>E</th></tr> <tr><td>1.778,-</td><td>1.994,-</td><td>2.164,-</td><td>2.436,-</td><td>2.829,-</td></tr> <tr><th>F</th><th>G</th><th>H</th><th>I</th><th>L</th></tr> <tr><td>2.637,-</td><td>2.185,-</td><td>2.712,-</td><td>3.358,-</td><td>3.633,-</td></tr> </table>	A	B	C	D	E	1.778,-	1.994,-	2.164,-	2.436,-	2.829,-	F	G	H	I	L	2.637,-	2.185,-	2.712,-	3.358,-	3.633,-
A	B	C	D	E																			
1.778,-	1.994,-	2.164,-	2.436,-	2.829,-																			
F	G	H	I	L																			
2.637,-	2.185,-	2.712,-	3.358,-	3.633,-																			

	600.11.100 Wand-Wanneneinlauf 3/4" <ul style="list-style-type: none"> Ausladung 175 mm Steckanschluß-Montage 	Tub wall spout 3/4" <ul style="list-style-type: none"> spout projection 175 mm special concealed wall attachment 	<table border="1"> <tr><th>A</th><th>B</th><th>C</th><th>D</th><th>E</th></tr> <tr><td>729,-</td><td>799,-</td><td>864,-</td><td>916,-</td><td>1.124,-</td></tr> <tr><th>F</th><th>G</th><th>H</th><th>I</th><th>L</th></tr> <tr><td>1.014,-</td><td>896,-</td><td>970,-</td><td>1.393,-</td><td>1.564,-</td></tr> </table>	A	B	C	D	E	729,-	799,-	864,-	916,-	1.124,-	F	G	H	I	L	1.014,-	896,-	970,-	1.393,-	1.564,-
	A	B	C	D	E																		
	729,-	799,-	864,-	916,-	1.124,-																		
F	G	H	I	L																			
1.014,-	896,-	970,-	1.393,-	1.564,-																			

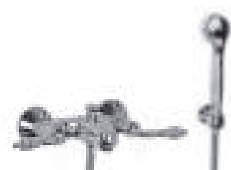
Badewanne, Aufputz-Batterien | Bath tub mixer sets, exposed

	611.20.100 Aufputz Wannenfüll- und Brausebatterie 1/2", mit Garnitur <ul style="list-style-type: none"> Designvariante RAMSES Ausladung 128 mm 2 keramische Oberteile 1/2" Metall-Handbrause mit Anti-Kalk-System und Rückflussverhinderer Metall-Brauseschlauch 1500 mm 	Exposed tub/shower mixer 1/2", incl. shower set <ul style="list-style-type: none"> design style RAMSES spout projection 128 mm 2 ceramic internal upper parts 1/2" metal hand shower with anticalc. system and backflow preventer metal shower hose 1500 mm 	<table border="1"> <tr><th>A</th><th>B</th><th>C</th><th>D</th><th>E</th></tr> <tr><td>1.069,-</td><td>1.309,-</td><td>1.553,-</td><td>1.747,-</td><td>2.058,-</td></tr> <tr><th>F</th><th>G</th><th>H</th><th>I</th><th>L</th></tr> <tr><td>1.987,-</td><td>1.567,-</td><td>1.912,-</td><td>2.355,-</td><td>3.285,-</td></tr> </table>	A	B	C	D	E	1.069,-	1.309,-	1.553,-	1.747,-	2.058,-	F	G	H	I	L	1.987,-	1.567,-	1.912,-	2.355,-	3.285,-
	A	B	C	D	E																		
	1.069,-	1.309,-	1.553,-	1.747,-	2.058,-																		
F	G	H	I	L																			
1.987,-	1.567,-	1.912,-	2.355,-	3.285,-																			
Griffvariante Handle alternative																							
	608.20.100 Aufputz Wannenfüll- und Brausebatterie 1/2", mit Garnitur <ul style="list-style-type: none"> Designvariante ALBANO 	Exposed tub/shower mixer 1/2", incl. shower set <ul style="list-style-type: none"> design style ALBANO 	<table border="1"> <tr><th>A</th><th>B</th><th>C</th><th>D</th><th>E</th></tr> <tr><td>1.069,-</td><td>1.309,-</td><td>1.553,-</td><td>1.747,-</td><td>2.058,-</td></tr> <tr><th>F</th><th>G</th><th>H</th><th>I</th><th>L</th></tr> <tr><td>1.987,-</td><td>1.567,-</td><td>1.912,-</td><td>2.355,-</td><td>3.285,-</td></tr> </table>	A	B	C	D	E	1.069,-	1.309,-	1.553,-	1.747,-	2.058,-	F	G	H	I	L	1.987,-	1.567,-	1.912,-	2.355,-	3.285,-
A	B	C	D	E																			
1.069,-	1.309,-	1.553,-	1.747,-	2.058,-																			
F	G	H	I	L																			
1.987,-	1.567,-	1.912,-	2.355,-	3.285,-																			

Dusche, Aufputz-Batterien | Shower mixer sets, exposed

	611.20.200 Brausebatterie 1/2" für Aufputzmontage <ul style="list-style-type: none"> Designvariante RAMSES 2 keramische Oberteile 1/2" Brauseabgang unten 1/2" 	Exposed shower mixer 1/2" <ul style="list-style-type: none"> design style RAMSES 2 ceramic internal upper parts 1/2" bottom discharge 1/2" 	<table border="1"> <tr><th>A</th><th>B</th><th>C</th><th>D</th><th>E</th></tr> <tr><td>590,-</td><td>730,-</td><td>823,-</td><td>926,-</td><td>1.089,-</td></tr> <tr><th>F</th><th>G</th><th>H</th><th>I</th><th>L</th></tr> <tr><td>994,-</td><td>1.008,-</td><td>1.262,-</td><td>1.268,-</td><td>1.848,-</td></tr> </table>	A	B	C	D	E	590,-	730,-	823,-	926,-	1.089,-	F	G	H	I	L	994,-	1.008,-	1.262,-	1.268,-	1.848,-
	A	B	C	D	E																		
	590,-	730,-	823,-	926,-	1.089,-																		
F	G	H	I	L																			
994,-	1.008,-	1.262,-	1.268,-	1.848,-																			
Griffvariante Handle alternative																							
	608.20.200 Brausebatterie 1/2" für Aufputzmontage <ul style="list-style-type: none"> Designvariante ALBANO 	Exposed shower mixer 1/2" <ul style="list-style-type: none"> design style ALBANO 	<table border="1"> <tr><th>A</th><th>B</th><th>C</th><th>D</th><th>E</th></tr> <tr><td>590,-</td><td>730,-</td><td>823,-</td><td>926,-</td><td>1.089,-</td></tr> <tr><th>F</th><th>G</th><th>H</th><th>I</th><th>L</th></tr> <tr><td>994,-</td><td>1.008,-</td><td>1.262,-</td><td>1.268,-</td><td>1.848,-</td></tr> </table>	A	B	C	D	E	590,-	730,-	823,-	926,-	1.089,-	F	G	H	I	L	994,-	1.008,-	1.262,-	1.268,-	1.848,-
A	B	C	D	E																			
590,-	730,-	823,-	926,-	1.089,-																			
F	G	H	I	L																			
994,-	1.008,-	1.262,-	1.268,-	1.848,-																			

RAMSES | ALBANO

Maßzeichnungen unter www.joerger.de - Menü SERVICE.
 Technical specifications under www.joerger.de - menu SERVICE.

A chrom chrome	[.000]	E platin matt platinum matt	[.066]
B silbernickel polished nickel	[.035]	F nerz matt milk matt	[.096]
C nerz milk	[.095]	G schwarz-matt black matt	[.092]
C nickel matt satin nickel	[.036]	G weiß-matt white matt	[.052]
D edelmessing sunshine	[.040]	H bronze bronze	[.011]
D platin platinum	[.065]	I gold gold	[.020]
E edelmess.matt sunshine matt	[.041]	L roségold rosegold	[.022]
E gold matt gold matt	[.021]	L roségold matt rosegold matt	[.023]

6xx.20.410 – Aufputz Set mit Steigrohr | Exposed set with shower system



649.13.920 Regenbrause ½", ø 200 mm <ul style="list-style-type: none"> ■ Ausführung ganz in Metall ■ mit Kugelgelenk ■ Anti-Kalk-System 	Rain shower head ½", ø 200 mm <ul style="list-style-type: none"> ■ full metal body ■ with ball joint ■ with anticalcareous system 	A	B	C	D	E
		260,-	619,-	824,-	895,-	1.268,-
		F	G	H	I	L
		1.085,-	821,-	1.098,-	1.389,-	2.189,-

649.20.280 Steigrohr, Umstellung, Wandarm <ul style="list-style-type: none"> ■ zum Anschluß an die Brausebatterie ■ Ausladung 360 - 380 mm ■ in der Neigung und Höhe verstellbare Brausehalterung 	Supply pipe, diverter, wall bracket <ul style="list-style-type: none"> ■ to connect the exposed shower mixer ■ projection 360 - 380 mm ■ fitting for handshower adjustable in height and inclination 	A	B	C	D	E
		589,-	932,-	1.198,-	1.362,-	1.741,-
		F	G	H	I	L
		1.599,-	1.318,-	1.649,-	1.895,-	2.529,-

600.13.700 Brausegarnitur <ul style="list-style-type: none"> ■ Metall-Handbrause mit Anti-Kalk-System und Rückflussverhinderer ■ Brauseschlauch 1500 mm, beidseitig mit drehbarem Konus 	Shower combination <ul style="list-style-type: none"> ■ metal hand shower with anticalc. system and backflow preventer ■ metal shower hose 1500 mm, both sides with turning cone 	A	B	C	D	E
		369,-	449,-	551,-	608,-	750,-
		F	G	H	I	L
		695,-	734,-	1.019,-	844,-	1.499,-

611.20.210 Aufputz-Brausebatterie ½" <ul style="list-style-type: none"> ■ Designvariante RAMSES ■ für Steigrohr ■ Brauseabgang ¾" 	Exposed shower mixer ½" <ul style="list-style-type: none"> ■ design style RAMSES ■ for supply pipe ■ discharge ¾" 	A	B	C	D	E
		590,-	730,-	823,-	926,-	1.089,-
		F	G	H	I	L
		994,-	1.008,-	1.262,-	1.268,-	1.848,-

Griffvariante | Handle alternative

Griffvariante | Handle alternative



608.20.210 Aufputz-Brausebatterie ½" <ul style="list-style-type: none"> ■ Designvariante ALBANO 	Exposed shower mixer ½" <ul style="list-style-type: none"> ■ design style ALBANO 	A	B	C	D	E
		590,-	730,-	823,-	926,-	1.089,-
		F	G	H	I	L
		994,-	1.008,-	1.262,-	1.268,-	1.848,-

611.20.250 Brausethermostat ½" für Aufputzmontage <ul style="list-style-type: none"> ■ Designvariante RAMSES ■ Sicherheitssperre bei 38° C ■ Keramik-Innenoberteil ½" ■ Brauseabgang unten ½" 	Exposed shower thermostat ½" <ul style="list-style-type: none"> ■ design style RAMSES ■ heat scale, locking device at 38° C ■ ceramic cartridge ½" ■ bottom discharge ½" 	A	B	C	D	E
		1.167,-	1.586,-	1.759,-	1.885,-	2.549,-
		F	G	H	I	L
		2.280,-	1.854,-	2.285,-	2.858,-	3.364,-



Griffvariante | Handle alternative

608.20.250 Brausethermostat ½" für Aufputzmontage <ul style="list-style-type: none"> ■ Designvariante ALBANO 	Exposed shower thermostat ½" <ul style="list-style-type: none"> ■ design style ALBANO 	A	B	C	D	E
		1.167,-	1.586,-	1.759,-	1.885,-	2.549,-
		F	G	H	I	L
		2.280,-	1.854,-	2.285,-	2.858,-	3.364,-







RAMSES | ALBANO

Maßzeichnungen unter www.joerger.de - Menü SERVICE.
 Technical specifications under www.joerger.de - menu SERVICE.

A chrom chrome	[.000]	E platin matt platinum matt	[.066]
B silbernickel polished nickel	[.035]	F nerz matt milk matt	[.096]
C nerz milk	[.095]	G schwarz-matt black matt	[.092]
C nickel matt satin nickel	[.036]	G weiß-matt white matt	[.052]
D edelmessing sunshine	[.040]	H bronze bronze	[.011]
D platin platinum	[.065]	I gold gold	[.020]
E edelmess.matt sunshine matt	[.041]	L roségold rosegold	[.022]
E gold matt gold matt	[.021]	L roségold matt rosegold matt	[.023]

6xx.20.460 – Aufputz Set mit Steigrohr | Exposed set with shower system



 649.13.920 Regenbrause ½", ø 200 mm ■ Ausführung ganz in Metall ■ mit Kugelgelenk ■ Anti-Kalk-System	Rain shower head ½", ø 200 mm ■ full metal body ■ with ball joint ■ with anticalcareous system	A	B	C	D	E
		260,-	619,-	824,-	895,-	1.268,-
 649.20.280 Steigrohr, Umstellung, Wandarm ■ zum Anschluß an die Brausebatterie ■ Ausladung 360 - 380 mm ■ in der Neigung und Höhe verstellbare Brausehalterung	Supply pipe, diverter, wall bracket ■ to connect the exposed shower mixer ■ projection 360 - 380 mm ■ fitting for handshower adjustable in height and inclination	A	B	C	D	E
		589,-	932,-	1.198,-	1.362,-	1.741,-
 600.13.700 Brausegarnitur ■ Metall-Handbrause mit Anti-Kalk-System und Rückflussverhinderer ■ Brauseschlauch 1.500 mm, beidseitig mit drehbarem Konus	Shower combination ■ metal hand shower with anticalc. system and backflow preventer ■ metal shower hose 1.500 mm, both sides with turning cone	A	B	C	D	E
		369,-	449,-	551,-	608,-	750,-
 611.20.260 Aufputz-Brausethermostat ½" ■ Designvariante RAMSES ■ für Steigrohr ■ Brauseabgang ¾"	Exposed shower thermostat ½" ■ design style RAMSES ■ for supply pipe ■ discharge ¾"	A	B	C	D	E
		1.215,-	1.634,-	1.807,-	1.933,-	2.597,-
Griffvariante Handle alternative		F	G	H	I	L
 608.20.260 Aufputz-Brausethermostat ½" ■ Designvariante ALBANO		2.328,-	1.902,-	2.333,-	2.906,-	3.412,-

Unterputz-Thermostate ½" | Wall thermostats, concealed ½"



611.40.380 Unterputz-Thermostat ½" mit Mengenregulierung, Fertigmontageset ■ manuelle, keramische Umstellung Wanne/Brause, druckunabhängig ■ mit Sicherheitseinrichtung ■ Durchflußrate 20,4 l/min bei 3 bar	Concealed wall thermostat ½" with flow control, assembly set ■ manual, ceramic diverter tub/shower for pressure-independent function ■ with safety device ■ flow rate 20,4 l/min at 3 bar	A	B	C	D	E
		1.078,-	1.297,-	1.534,-	1.573,-	1.871,-
		F	G	H	I	L
		1.726,-	1.497,-	1.798,-	2.044,-	2.921,-

Variante | Alternative



611.40.360 Unterputz-Thermostat ½" mit Mengenregulierung, Fertigmontageset ■ ohne Umstellung ■ mit integrierter keramischer Mengenregulierung ■ Durchflußrate 20,4 l/min bei 3 bar	Concealed wall thermostat ½" with flow control, assembly set ■ without diverter ■ with integrated ceramic cartridge for volume control ■ flow rate 20,4 l/min at 3 bar	A	B	C	D	E
		1.043,-	1.241,-	1.477,-	1.516,-	1.815,-
		F	G	H	I	L
		1.671,-	1.441,-	1.742,-	1.986,-	2.838,-

Variante | Alternative



600.40.460 Unterputz-Thermostat ½" ohne Mengenregulierung, Fertigmontageset ■ Funktionseinheit ohne Umstellung und ohne Absperrung ■ Durchflußrate 25,8 l/min bei 3 bar	Concealed wall thermostat ½" without flow control, assembly set ■ Functional unit without diverter and without shut-off ■ flow rate 25,8 l/min at 3 bar	A	B	C	D	E
		884,-	984,-	1.246,-	1.276,-	1.548,-
		F	G	H	I	L
		1.431,-	1.051,-	1.488,-	1.707,-	1.919,-

Benötigt | Required



649.40.360 Unterputz-Einbaubox ½" ■ zu Fertigmontageset 611.40.360, 611.40.380 und 600.40.460 ■ für Nass- und Trockenbau geeignet	Concealed wall box ½" ■ for assembly set 611.40.360, 611.40.380 and 600.40.460 ■ for wetwall and drywall construction	A				
		168,-				

Maßzeichnungen unter www.joerger.de - Menü SERVICE.
 Technical specifications under www.joerger.de - menu SERVICE.

A chrom chrome	[.000]	E platin matt platinum matt	[.066]
B silbernickel polished nickel	[.035]	F nerz matt mink matt	[.096]
C nerz mink	[.095]	G schwarz-matt black matt	[.092]
C nickel matt satin nickel	[.036]	G weiß-matt white matt	[.052]
D edelmessing sunshine	[.040]	H bronze bronze	[.011]
D platin platinum	[.065]	I gold gold	[.020]
E edelmess.matt sunshine matt	[.041]	L roségold rosegold	[.022]
E gold matt gold matt	[.021]	L roségold matt rosegold matt	[.023]

Unterputz-Thermostat ¾" mit hohem Durchfluß | Wall thermostat, concealed ¾" with high flow



611.40.560 Unterputz-Thermostat ¾"
ohne Mengenregulierung,
 Fertigmontageset
 ■ serienbezogener Temperiergriff
 ■ Sicherheitssperre bei 38° C

Concealed wall thermostat ¾"
without flow control,
 assembly set
 ■ design handle for temp. control
 ■ locking device at 38° C

A	B	C	D	E
574,-	829,-	1.035,-	1.079,-	1.388,-
F	G	H	I	L
1.219,-	719,-	1.478,-	1.624,-	1.865,-

Benötigt | Required



649.40.555 Unterputz-Einbaukörper ¾"
 ■ zu Fertigmontageset 611.40.555
 ■ Kartusche mit Schmutzfangsieben
 ■ für Nass- und Trockenbau geeignet
 ■ Durchflußrate 64,2 l/min bei 3 bar
 ■ ohne Absperrung

Concealed thermostat body ¾"
 ■ for assembly set 611.40.555
 ■ cartridge with filter screens
 ■ for wetwall and drywall construction
 ■ flow rate 64,2 l/min at 3 bar
 ■ without shut-off

A	B	C	D	E
1.636,-				

Unterputz-Thermostat ¾" | Wall thermostat, concealed ¾"



611.40.520 Unterputz-Thermostat ¾"
ohne Mengenregulierung,
 Fertigmontageset
 ■ serienbezogener Temperiergriff
 ■ Sicherheitssperre bei 38° C

Concealed wall thermostat ¾"
without flow control,
 assembly set
 ■ design handle for temp. control
 ■ locking device at 38° C

A	B	C	D	E
574,-	829,-	1.035,-	1.079,-	1.388,-
G	H	I	K	L
1.219,-	719,-	1.478,-	1.624,-	1.865,-

Benötigt | Required



649.40.520 Unterputz-Einbaukörper ¾"
 ■ zu Fertigmontageset 611.40.520
 ■ Kartusche mit Schmutzfangsieben
 ■ für Nass- und Trockenbau geeignet
 ■ Durchflußrate 41 l/min bei 3 bar
 ■ ohne Absperrung

Concealed thermostat body ¾"
 ■ for assembly set 611.40.520
 ■ cartridge with filter screens
 ■ for wetwall and drywall construction
 ■ flow rate 41 l/min at 3 bar
 ■ without shut-off

A	B	C	D	E
498,-				

Unterputz-Umstellung und Ventile | Diverter and valves concealed



611.40.650 Unterputz 3-Wege Umstellung
 Fertigmontageset
 ■ Griff, Hülse
 ■ Schubrosette

Concealed 3-position diverter
 assembly set
 ■ handle, socket
 ■ escutcheon

A	B	C	D	E
254,-	325,-	356,-	400,-	470,-
F	G	H	I	L
438,-	358,-	453,-	558,-	650,-

Benötigt | Required



649.40.600 Unterputz 3-Wege Umstellung ½"
 Einbaukörper
 ■ zu Fertigmontageset 611.40.650

Concealed 3-position diverter ½"
 diverter body
 ■ for assembly set 611.40.650

A	B	C	D	E
236,-				



611.50.234 Unterputz-Ventil, Fertigmontageset
 ■ Griff, Hülse
 ■ Schubrosette

Concealed wall valve,
 assembly set
 ■ handle, socket
 ■ escutcheon

A	B	C	D	E
207,-	276,-	290,-	326,-	384,-
F	G	H	I	L
356,-	304,-	399,-	455,-	600,-

Benötigt | Required



649.20.340 Unterputz-Ventil ½", Einbaukörper
 ■ rechtsschließend, ker. Scheiben

Concealed wall valve ½", body
 ■ clockwise closure, ceramic discs

A	B	C	D	E
62,-				



649.20.345 Unterputz-Ventil ½", Einbaukörper
 ■ linksschließend, ker. Scheiben

Concealed wall valve ½", body
 ■ counter-clockwise closure, cer. discs

A	B	C	D	E



649.20.440 Unterputz-Ventil ¾", Einbaukörper
 ■ rechtsschließend, ker. Scheiben

Concealed wall valve ¾", body
 ■ clockwise closure, ceramic discs

A	B	C	D	E
106,-				

649.20.445 Unterputz-Ventil ¾", Einbaukörper
 ■ linksschließend, ker. Scheiben











Concealed wall valve ¾", body
 ■ counter-clockwise closure, cer. discs

A	B	C	D	E

Maßzeichnungen unter www.joerger.de - Menü SERVICE.
 Technical specifications under www.joerger.de - menu SERVICE.

A chrom chrome	[.000]	E platin matt platinum matt	[.066]
B silbernickel polished nickel	[.035]	F nerz matt mink matt	[.096]
C nerz mink	[.095]	G schwarz-matt black matt	[.092]
C nickel matt satin nickel	[.036]	G weiß-matt white matt	[.052]
D edelmessing sunshine	[.040]	H bronze bronze	[.011]
D platin platinum	[.065]	I gold gold	[.020]
E edelmess.matt sunshine matt	[.041]	L roségold rosegold	[.022]
E gold matt gold matt	[.021]	L roségold matt rosegold matt	[.023]

Unterputz-Thermostat/Ventil-Modul | Concealed thermostatic/wall-valve modul





		A	B	C	D	E	
	611.60.432 Unterputz-Ventil-Modul Fertigmontageset <ul style="list-style-type: none"> mit Kreuzgriff Rosette 	Concealed wall-valve-modul assembly set <ul style="list-style-type: none"> with cross handle escutcheon 	254,-	325,-	356,-	400,-	470,-
	Benötigt Required		F	G	H	I	L
			439,-	359,-	453,-	558,-	650,-
	649.20.610 Unterputz-Ventil-Modul, 1-fach <ul style="list-style-type: none"> 1x Spindelventil 3/4", rechtsschließend mit keram. Scheiben 2 Abgänge 1/2", je 1x rechts/links möglich, gleichzeitig benutzbar 	Concealed wall-valve-modul, single <ul style="list-style-type: none"> 1x spindle valve 3/4", clockwise closure with ceramic discs 2 outlets 1/2", each 1x right/left possible, simultaneously usable 	A				
			229,-				
	649.20.620 Unterputz-Ventil-Modul, 2-fach <ul style="list-style-type: none"> 2x Spindelventil 3/4", rechtsschließend mit keram. Scheiben 4 Abgänge 1/2", je 2x rechts/links möglich, gleichzeitig benutzbar im Verbund maßgenaue Montage erweiterbar mit 649.20.610 	Concealed wall-valve-modul, double <ul style="list-style-type: none"> 2x spindle valve 3/4", clockwise closure with ceramic discs 4 outlets 1/2", each 2x right/left possible, simultaneously usable precise assembly due to composite expandable with 649.20.610 	A				
			458,-				
	649.20.630 Unterputz-Ventil-Modul, 3-fach <ul style="list-style-type: none"> 3x Spindelventil 3/4", rechtsschließend mit keram. Scheiben 6 Abgänge 1/2", je 3x rechts/links möglich, gleichzeitig benutzbar im Verbund maßgenauen Montage erweiterbar mit 649.20.610 	Concealed wall-valve-modul, triple <ul style="list-style-type: none"> 3x spindle valve 3/4", clockwise closure with ceramic discs 6 outlets 1/2", each 3x right/left possible, simultaneously usable precise assembly due to composite expandable with 649.20.610 	A				
			686,-				
	600.40.460 Unterputz-Thermostat 1/2" <u>ohne</u> Mengenregulierung, Fertigmontageset <ul style="list-style-type: none"> Funktionseinheit <u>ohne</u> Umstellung und <u>ohne</u> Absperrung Durchflussrate 25,8 l/min bei 3 bar 	Concealed wall thermostat 1/2" <u>without</u> flow control, assembly set <ul style="list-style-type: none"> Functional unit <u>without</u> diverter and <u>without</u> shut-off flow rate 25,8 l/min at 3 bar 	A	B	C	D	E
			884,-	984,-	1.246,-	1.276,-	1.548,-
			F	G	H	I	L
		1.431,-	1.051,-	1.488,-	1.707,-	1.919,-	
	649.20.612 Anschlußadapter 1/2" <ul style="list-style-type: none"> Anschlußadapter, Abschlußstopfen passend zu Einbaubox 649.40.360 	Connection adapter 1/2" <ul style="list-style-type: none"> connection adapter, end plug matching to wall box 649.40.360 	A				
			122,-				
	649.40.360 Unterputz-Einbaubox 1/2" <ul style="list-style-type: none"> zu Fertigmontageset 600.40.460 für Nass- und Trockenbau geeignet 	Concealed wall box 1/2" <ul style="list-style-type: none"> for assembly set 600.40.460 for wetwall and drywall construction 	A				
			168,-				
	611.40.560 Unterputz-Thermostat 3/4" <u>ohne</u> Mengenregulierung, Fertigmontageset <ul style="list-style-type: none"> serienbezogener Temperiergriff Sicherheitsperre bei 38° C 	Concealed wall thermostat 3/4" <u>without</u> flow control, assembly set <ul style="list-style-type: none"> design handle for temp. control locking device at 38° C 	A	B	C	D	E
			574,-	829,-	1.035,-	1.079,-	1.388,-
			F	G	H	I	L
		1.219,-	719,-	1.478,-	1.624,-	1.865,-	
	649.20.634 Anschlußadapter 3/4" <ul style="list-style-type: none"> Anschlußadapter, Abschlußstopfen passend zu Einbaukörper 649.40.555 	Connection adapter 3/4" <ul style="list-style-type: none"> connection adapter, end plug matching to wall body 649.40.555 	A				
			146,-				
	649.40.555 Unterputz-Einbaukörper 3/4" <ul style="list-style-type: none"> zu Fertigmontageset 611.40.555 Kartusche mit Schmutzfängsieben für Nass- und Trockenbau geeignet Durchflussrate 64,2 l/min bei 3 bar <u>ohne</u> Absperrung 	Concealed thermostat body 3/4" <ul style="list-style-type: none"> for assembly set 611.40.555 cartridge with filter screens for wetwall and drywall construction flow rate 64,2 l/min at 3 bar <u>without</u> shut-off 	A				
			1.636,-				

RAMSES | ALBANO

Maßzeichnungen unter www.joerger.de - Menü SERVICE.
 Technical specifications under www.joerger.de - menu SERVICE.

A chrom chrome	[.000]	E platin matt platinum matt	[.066]
B silbernickel polished nickel	[.035]	F nerz matt milk matt	[.096]
C nerz milk	[.095]	G schwarz-matt black matt	[.092]
C nickel matt satin nickel	[.036]	G weiß-matt white matt	[.052]
D edelmessing sunshine	[.040]	H bronze bronze	[.011]
D platin platinum	[.065]	I gold gold	[.020]
E edelmess.matt sunshine matt	[.041]	L roségold rosegold	[.022]
E gold matt gold matt	[.021]	L roségold matt rosegold matt	[.023]

Brausen | Showers

		A	B	C	D	E		
	611.13.310 Duschgarnitur, komplett <ul style="list-style-type: none"> Wandrohr 780 mm, mit Schieber Metall-Handbrause mit Anti-Kalk-System und Rückflussverhinderer Metall-Brauseschlauch 1750 mm, beidseitig mit drehbarem Konus 	Shower bar set, complete <ul style="list-style-type: none"> wall bar 780 mm, with slider metal hand shower with anticalc. system and backflow preventer metal shower hose 1750 mm, both sides with turning cone 		938,-	1.134,-	1.208,-	1.264,-	1.578,-
			F	G	H	I	L	
		1.439,-	1.514,-	1.985,-	1.724,-	3.309,-		
	611.13.350 Duschstange, lose <ul style="list-style-type: none"> Wandrohr 780 mm, mit Schieber 	Shower bar, separate <ul style="list-style-type: none"> wall bar 780 mm, with slider 		495,-	766,-	808,-	854,-	1.006,-
			F	G	H	I	L	
		941,-	797,-	1.546,-	1.160,-	1.933,-		
	600.13.200 Schlauchbrausegarnitur <ul style="list-style-type: none"> Wandanschlußbogen 1/2" Wand-Brausehalter Metall-Handbrause mit Anti-Kalk-System und Rückflussverhinderer Metall-Brauseschlauch 1500 mm, beidseitig mit drehbarem Konus 	Shower combination <ul style="list-style-type: none"> Wall elbow connection 1/2" Wall fitting for hand shower metal hand shower with anticalc. system and backflow preventer flexible metal shower hose 1500 mm, both sides with turning cone 		592,-	727,-	809,-	910,-	1.072,-
			F	G	H	I	L	
		946,-	948,-	1.259,-	1.139,-	1.784,-		
	600.13.150 Wandanschlußbogen 1/2", ohne Haken <ul style="list-style-type: none"> Brauseabgang 1/2" mit Rückflussverhinderer, Rosette 	Wall elbow connection 1/2", without cradle <ul style="list-style-type: none"> discharge 1/2" with backflow preventer, escutcheon 		99,-	134,-	139,-	157,-	185,-
			F	G	H	I	L	
		169,-	158,-	198,-	208,-	314,-		
	649.13.210 Wand-Brausehalter	Wall fitting for hand shower		178,-	214,-	266,-	287,-	337,-
			F	G	H	I	L	
		299,-	256,-	325,-	374,-	459,-		
	600.13.237 Hygienebrausegarnitur <ul style="list-style-type: none"> Wandbrausehalter und -anschlußbogen 1/2", Schubrossette Hygienebrause, klassisch (649.13.338), komplett aus Metall einstrahlig, Bedienung über Druckhebel Metall-Brauseschlauch 1250 mm 	Ablution spray combination <ul style="list-style-type: none"> wall fitting and elbow connection 1/2" spray handshower, classical (649.13.338), completely metal one jet, push-lever operation flexible metal shower hose 1250 mm 		332,-	404,-	645,-	676,-	893,-
			F	G	H	I	L	
		772,-	669,-	998,-	1.081,-	1.529,-		
	607.20.237 1-Hand Batterie 1/2" für Hygiene-Brause, Fertigmontageset <ul style="list-style-type: none"> Rosette, Griff mit Hebelgriff 	Concealed single lever 1/2" for ablution spray, assembly set <ul style="list-style-type: none"> escutcheon, handle with lever handle 		296,-	378,-	490,-	552,-	649,-
			F	G	H	I	L	
		594,-	534,-	612,-	754,-	911,-		
	649.20.237 Unterputz 1-Hand Batterie 1/2", Einbaukörper <ul style="list-style-type: none"> Kartusche mit keramischen Scheiben zu Fertigmontageset 601.20.237 	Single lever mixer 1/2", concealed body <ul style="list-style-type: none"> cartridge with ceramic discs for assembly set 601.20.237 		125,-	169,-	208,-	229,-	268,-
			F	G	H	I	L	
		249,-	224,-	258,-	329,-	396,-		

Benötigt | Required

RAMSES | ALBANO

Maßzeichnungen unter www.joerger.de - Menü SERVICE.
 Technical specifications under www.joerger.de - menu SERVICE.

A chrom chrome	[.000]	E platin matt platinum matt	[.066]
B silbernickel polished nickel	[.035]	F nerz matt mink matt	[.096]
C nerz mink	[.095]	G schwarz-matt black matt	[.092]
C nickel matt satin nickel	[.036]	G weiß-matt white matt	[.052]
D edelmessing sunshine	[.040]	H bronze bronze	[.011]
D platin platinum	[.065]	I gold gold	[.020]
E edelmess.matt sunshine matt	[.041]	L roségold rosegold	[.022]
E gold matt gold matt	[.021]	L roségold matt rosegold matt	[.023]



- 649.13.615 Stachelkopfbrause 1/2"**
- ø 230 mm, 75 Düsen
 - Ausführung ganz in Metall
 - Anti-Kalk-System
 - Brausekopf schwenkbar
 - ohne Wandarm
- weitere, zur Serie passende Kopfbrausen siehe Kapitel "Brausen"

- Body spray shower head 1/2"**
- ø 230 mm, 75 jets
 - full metal body
 - anticalcareous system
 - swivel shower head
 - without wall bracket
- for further shower heads matching this collection see chapter "showers"

A	B	C	D	E
969,-	1.232,-	1.359,-	1.416,-	1.659,-
F	G	H	I	L
1.496,-	1.399,-	1.718,-	2.262,-	2.739,-

Empfohlen | Recommended



- 649.13.625 Wandarm 1/2"**
- Ausladung 162 mm
- weitere, zur Serie passende Wandarme siehe Kapitel "Brausen"

- Wall bracket 1/2"**
- projection 162 mm
- for further wall brackets matching this collection see chapter "showers"

A	B	C	D	E
126,-	145,-	171,-	189,-	250,-
F	G	H	I	L
229,-	192,-	296,-	286,-	499,-



- 649.13.519 Seitenbrause 1/2"**
- Rosette ø 130 mm, Wandmontage
 - Brausekopf schwenkbar, 20°
 - Anti-Kalk-System
 - Ausführung Kunststoff
- weitere, zur Serie passende Seitenbrausen siehe Kapitel "Brausen"

- Body spray side shower 1/2"**
- escutcheon ø 130 mm, wall assembly
 - swivel shower head, 20°
 - anticalcareous system
 - plastic
- for further side showers matching this collection see chapter "showers"

A	B	C	D	E
167,-	326,-	385,-	399,-	542,-
F	G	H	I	L
496,-	376,-	472,-	634,-	949,-

RAMSES | ALBANO

Maßzeichnungen unter www.joerger.de - Menü SERVICE.
 Technical specifications under www.joerger.de - menu SERVICE.

A chrom chrome	[.000]	E platin matt platinum matt	[.066]
B silbernickel polished nickel	[.035]	F nerz matt mink matt	[.096]
C nerz mink	[.095]	G schwarz-matt black matt	[.092]
C nickel matt satin nickel	[.036]	G weiß-matt white matt	[.052]
D edelmessing sunshine	[.040]	H bronze bronze	[.011]
D platin platinum	[.065]	I gold gold	[.020]
E edelmess.matt sunshine matt	[.041]	L roségold rosegold	[.022]
E gold matt gold matt	[.021]	L roségold matt rosegold matt	[.023]

Accessoires für Handtücher | Accessories for towels

	611.00.002 Handtuchhalter, doppelt ■ Rohre schwenkbar, ca. 430 mm	Double towel bar ■ swivelling bars, approx. 430 mm	A	B	C	D	E
	611.00.012 Handtuchhalter, doppelt ■ verkürzt, ca. 300 mm	Double towle bar ■ shortened, approx. 300 mm	F	G	H	I	L
			584,-	658,-	699,-	786,-	963,-
			867,-	717,-	840,-	1.183,-	1.310,-

	611.00.047 Handtuchring ■ ø ca. 190 mm ■ geschlossene Ausführung	Towel ring ■ ø approx. 190 mm ■ closed version	A	B	C	D	E
			F	G	H	I	L
			260,-	392,-	416,-	467,-	574,-
			529,-	393,-	479,-	668,-	825,-

	611.00.022 Handtuchhaken	Robe hanger	A	B	C	D	E
			F	G	H	I	L
			233,-	327,-	361,-	405,-	499,-
			476,-	365,-	484,-	603,-	576,-

	611.00.040 Badetuchhalter ■ ca. 800 mm	Bath towel bar ■ approx. 800 mm	A	B	C	D	E
			F	G	H	I	L
			457,-	658,-	695,-	712,-	842,-
			790,-	597,-	856,-	997,-	1.673,-

	611.00.031 Wannengriff ■ ca. 300 mm	Tub handle ■ approx. 300 mm	A	B	C	D	E
			F	G	H	I	L
			397,-	585,-	606,-	623,-	705,-
			663,-	504,-	624,-	865,-	1.079,-

	611.00.104 Gästehandtuchkorb, eckig ■ mit Ablage ■ Korbgröße 260 x 150 x 190 mm	Guest towel basket, angular ■ with shelf ■ basket size 260 x 150 x 190 mm	A	B	C	D	E
			F	G	H	I	L
			411,-	586,-	618,-	664,-	809,-
			738,-	642,-	1.049,-	894,-	1.958,-

Accessoires für Waschplatz | Accessories for washstands

	611.00.007 Seifenhalter, komplett ■ Seifenschale aus Kristallglas	Soap dish holder, complete ■ crystal glass dish	A	B	C	D	E
			F	G	H	I	L
			444,-	480,-	538,-	605,-	734,-
			675,-	476,-	615,-	890,-	965,-

700.00.307 Seifenschale, lose	Glass dish, separate	A				
			99,-			

RAMSES | ALBANO

Maßzeichnungen unter www.joerger.de - Menü SERVICE.
 Technical specifications under www.joerger.de - menu SERVICE.

A chrom chrome	[.000]	E platin matt platinum matt	[.066]
B silbernickel polished nickel	[.035]	F nerz matt mink matt	[.096]
C nerz mink	[.095]	G schwarz-matt black matt	[.092]
C nickel matt satin nickel	[.036]	G weiß-matt white matt	[.052]
D edelmessing sunshine	[.040]	H bronze bronze	[.011]
D platin platinum	[.065]	I gold gold	[.020]
E edelmess.matt sunshine matt	[.041]	L roségold rosegold	[.022]
E gold matt gold matt	[.021]	L roségold matt rosegold matt	[.023]

	611.00.105 Schwammkorb ■ rechteckig, 260 x 130 mm	Sponge basket ■ rectangular, 260 x 130 mm	A	B	C	D	E
			325,-	562,-	608,-	634,-	798,-
			F	G	H	I	L
			726,-	630,-	812,-	874,-	1.319,-

	611.00.106 Eckschwammkorb ■ 195 x 195 mm	Corner sponge basket ■ 195 x 195 mm	A	B	C	D	E
			296,-	529,-	554,-	574,-	704,-
			F	G	H	I	L
			646,-	626,-	736,-	764,-	1.228,-

	611.00.006 Lotionsspender, komplett	Soap dispenser, complete	A	B	C	D	E
			524,-	558,-	583,-	612,-	742,-
			F	G	H	I	L
			699,-	579,-	639,-	899,-	968,-

	713.00.306 Lotionsspenderglas, lose ■ seidenmatt, ohne Pumpe	Soap dispenser glass, separate ■ frosted, without pump	A				
			78,-				

	611.00.036 Glashalter, komplett ■ Glas aus Kristallglas	Tumbler holder, complete ■ crystal glass tumbler	A	B	C	D	E
			466,-	479,-	534,-	599,-	728,-
			F	G	H	I	L
			681,-	492,-	612,-	886,-	976,-

	700.00.336 Mundglas, lose	Glass tumbler, separate	A				
			96,-				

	611.00.009 Ablage, 600 mm ■ Glasplatte aus Kristallglas	Shelf holder with glass, 600 mm ■ crystal glass shelf	A	B	C	D	E
			688,-	724,-	749,-	768,-	907,-
			F	G	H	I	L
			865,-	804,-	799,-	1.107,-	1.156,-

Accessoires für WC-Bereich | Accessories for w.c. area

	611.00.014 Papierhalter ■ mit Deckel	Toilet paper roll holder ■ with lid	A	B	C	D	E
			408,-	465,-	645,-	726,-	890,-
			F	G	H	I	L
			819,-	531,-	784,-	1.089,-	1.180,-

	611.00.015 Reserve-Papierhalter	Spare toilet paper roll holder	A	B	C	D	E
			256,-	282,-	396,-	445,-	546,-
			F	G	H	I	L
			508,-	286,-	456,-	655,-	682,-

RAMSES | ALBANO

Maßzeichnungen unter www.joerger.de - Menü SERVICE.
 Technical specifications under www.joerger.de - menu SERVICE.

A chrom chrome	[.000]	E platin matt platinum matt	[.066]
B silbernickel polished nickel	[.035]	F nerz matt milk matt	[.096]
C nerz milk	[.095]	G schwarz-matt black matt	[.092]
C nickel matt satin nickel	[.036]	G weiß-matt white matt	[.052]
D edelmessing sunshine	[.040]	H bronze bronze	[.011]
D platin platinum	[.065]	I gold gold	[.020]
E edelmess.matt sunshine matt	[.041]	L roségold rosegold	[.022]
E gold matt gold matt	[.021]	L roségold matt rosegold matt	[.023]



611.00.000 Klosettbürstengarnitur, komplett
 ■ Glas aus Kristallglas, seidenmatt
 Toilet brush holder set, complete
 ■ crystal glass, frosted

A	B	C	D	E
766,-	825,-	855,-	872,-	968,-
F	G	H	I	L
905,-	797,-	994,-	1.080,-	1.325,-

799.00.300 Bürstenglas, seidenmatt, lose
 Brush glass, frosted, separate

A	B	C	D	E
48,-				

650.00.053 Bürstenstange komplett, lose
 Brush rod with brush, separate

A	B	C	D	E
139,-	189,-	215,-	242,-	296,-
F	G	H	I	L
269,-	179,-	224,-	349,-	476,-

799.00.238 Bürstenkopf, lose
 Brush, separate

A	B	C	D	E
19,-				

Leuchten und Spiegel | Lamps and mirrors



611.00.061 Wandleuchte, komplett
 ■ mit Leuchtmittel, 40 W
 Wall lamp, complete
 ■ light bulb included, 40 W

A	B	C	D	E
644,-	748,-	904,-	1.016,-	1.198,-
F	G	H	I	L
1.086,-	1.044,-	1.112,-	1.524,-	2.221,-

710.00.361 Leuchtenglas, lose
 ■ Leuchtenglas gewolkt
 Glass, separate
 ■ clouded glass

A	B	C	D	E
216,-				



649.00.414 Kosmetikspiegel, beleuchtet
 ■ schwenk- und ausziehbar
 ■ 3-fache Vergrößerung
 ■ Direktanschluss
 ■ Spiegeldurchmesser 185 mm
 ■ Rahmendurchmesser 250 mm
 ■ Kalt-, Warm- und Taglicht durch Piezzo-Schalter umschaltbar
 Cosmetic mirror, incl. lighting
 ■ swivelling and extendable
 ■ magnification 3:1
 ■ direct connection
 ■ mirror diameter 185 mm
 ■ frame diameter 250 mm
 ■ cold, warm and day light switchable by Piezzo switch

A	B	C	D	E
556,-	988,-	1.214,-	1.418,-	1.828,-
F	G	H	I	L
1.684,-	1.214,-	1.549,-	2.138,-	2.998,-



MINARETT



Oberflächen | colours

Folgende Oberflächen sind bei dieser Serie möglich |
The following colours are possible with this collection

chrom	chrome	[.000] PG A
silbernickel	polished nickel	[.035] PG B
nerz	mink	[.095] PG C
nickel matt	satin nickel	[.036] PG C
edelmessing	sunshine	[.040] PG D
platin	platinum	[.065] PG D
edelmessing matt	sunshine matt	[.041] PG E
gold matt	gold matt	[.021] PG E
platin matt	platinum matt	[.066] PG E
nerz matt	mink matt	[.096] PG F
schwarz matt	black matt	[.092] PG G
weiß matt	white matt	[.052] PG G
bronze	bronze	[.011] PG H
gold	gold	[.020] PG I
roségold	rosegold	[.022] PG L
roségold matt	rosegold matt	[.023] PG L

Andere Oberflächen auf Anfrage |
Different colours on request

Auf Anfrage können wir Produkte von Drittanbietern auch gerne passend zu unseren Oberflächen veredeln (vorbehaltlich der Eignungsprüfung) | Third-party products may be plated matching to our colours on request (subject to valuation of suitability)

Waschtisch | Washbasin

ab Seite | from page 358

Bidet | Bidet

ab Seite | from page 358

Wanne | Bath tub

ab Seite | from page 359

Dusche | Shower

ab Seite | from page 359

Accessoires | Accessories





ab Seite | from page 365

MINARETT



Maßzeichnungen unter www.joerger.de - Menü SERVICE.
 Technical specifications under www.joerger.de - menu SERVICE.

A chrom chrome	[.000]	E platin matt platinum matt	[.066]
B silbernickel polished nickel	[.035]	F nerz matt mink matt	[.096]
C nerz mink	[.095]	G schwarz-matt black matt	[.092]
C nickel matt satin nickel	[.036]	G weiß-matt white matt	[.052]
D edelmessing sunshine	[.040]	H bronze bronze	[.011]
D platin platinum	[.065]	I gold gold	[.020]
E edelmess.matt sunshine matt	[.041]	L roségold rosegold	[.022]
E gold matt gold matt	[.021]	L roségold matt rosegold matt	[.023]



Waschtisch Batterien | Washbasin mixer

	603.30.300 Waschtisch 3-Loch Batterie 1/2" ■ Ausladung 130 mm; Höhe 165 mm ■ Exzenter-Ablaufgarnitur 1 1/4" ■ empfohlen: 2x 649.15.530 - Kupferrohr 300 mm	Washbasin 3-hole mixer 1/2" ■ spout projection 130 mm; height 165 mm ■ pop-up waste 1 1/4" ■ recommended: 2x 649.15.530 - copper tube 300 mm	A	B	C	D	E
			973,-	1.276,-	1.476,-	1.661,-	1.955,-
			F	G	H	I	L
			1.820,-	1.605,-	1.899,-	2.245,-	3.344,-
	603.10.300 Waschtisch 1-Loch Batterie 1/2" ■ Ausladung 125 mm; Höhe 165 mm ■ Keramik-Innenoberteile 1/2" ■ Exzenter-Ablaufgarnitur 1 1/4" ■ 2 Kupferrohre M10x1 x 400 mm	Washbasin 1-hole mixer 1/2" ■ spout projection 125 mm; height 165 mm ■ ceramic internal upper parts 1/2" ■ pop-up waste 1 1/4" ■ 2 copper tubes M10x1 x 400 mm	A	B	C	D	E
			875,-	1.158,-	1.329,-	1.495,-	1.760,-
			F	G	H	I	L
			1.617,-	1.392,-	1.548,-	2.090,-	2.733,-
	603.10.400 Standventil 1/2" ■ Ausladung 95 mm ■ starrer Auslauf ■ Fettkammer-Innenoberteil 1/2"	Deck mount tap 1/2" ■ spout projection 95 mm ■ rigid spout ■ cartridge 1/2"	A	B	C	D	E
			205,-	244,-	316,-	355,-	437,-
			F	G	H	I	L
			394,-	646,-	672,-	528,-	879,-
	603.10.500 Wand-Auslaufventil 1/2" ■ Ausladung 95 mm ■ Fettkammer-Innenoberteil 1/2"	Wall tap 1/2" ■ spout projection 95 mm ■ cartridge 1/2"	A	B	C	D	E
			254,-	262,-	370,-	415,-	486,-
			F	G	H	I	L
			455,-	674,-	536,-	572,-	865,-

Bidet Batterien | Bidet mixer

	603.30.100 Bidet 3-Loch Batterie 1/2" ■ Ausladung 105 mm; Höhe 104 mm ■ Exzenter-Ablaufgarnitur 1 1/4" ■ empfohlen: 2x 649.15.530 - Kupferrohr 300 mm	Bidet 3-hole mixer 1/2" ■ spout projection 105 mm; height 104 mm ■ pop-up waste 1 1/4" ■ recommended: 2x 649.15.530 - copper tube 300 mm	A	B	C	D	E
			1.165,-	1.219,-	1.666,-	1.875,-	2.208,-
			F	G	H	I	L
			2.048,-	1.626,-	1.982,-	2.434,-	3.548,-
	603.10.100 Bidet 1-Loch Batterie 1/2" ■ Ausladung 115 mm; Höhe 112 mm ■ Keramik-Innenoberteile 1/2" ■ Exzenter-Ablaufgarnitur 1 1/4" ■ 2 Kupferrohre M10x1 x 400 mm	Bidet 1-hole mixer 1/2" ■ spout projection 115 mm; height 112 mm ■ ceramic internal upper parts 1/2" ■ pop-up waste 1 1/4" ■ 2 copper tubes M10x1 x 400 mm	A	B	C	D	E
			1.018,-	1.308,-	1.456,-	1.638,-	1.930,-
			F	G	H	I	L
			1.782,-	996,-	1.659,-	2.238,-	2.412,-

Zubehör für Waschtisch- und Bidet-Batterien | Supplies for washbasin and bidet mixer

	603.12.100 Eckventil 1/2" ■ Ausladung 105 mm ■ Fettkammer-Innenoberteil 1/2" ■ Quetschverschraubung	Angle valve 1/2" ■ projection 105 mm ■ cartridge 1/2" ■ compression joint	A	B	C	D	E
			228,-	288,-	309,-	347,-	411,-
			F	G	H	I	L
			398,-	318,-	489,-	477,-	733,-
	649.15.530 Kupferrohr, 300 mm ■ mit Bördel, für Quetschverschraubung	Copper tube, 300 mm ■ with flange, for compression joint	A	B	C	D	E
			15,-	38,-	55,-	62,-	74,-
			F	G	H	I	L
			69,-	75,-	94,-	112,-	169,-
	649.15.550 Kupferrohr, 500 mm ■ mit Bördel, für Quetschverschraubung	Copper tube, 500 mm ■ with flange, for compression joint	A	B	C	D	E
			20,-	58,-	77,-	87,-	102,-
			F	G	H	I	L
			97,-	77,-	96,-	134,-	219,-

MINARETT

Maßzeichnungen unter www.joerger.de - Menü SERVICE.
 Technical specifications under www.joerger.de - menu SERVICE.

A chrom chrome	[.000]	E platin matt platinum matt	[.066]
B silbernickel polished nickel	[.035]	F nerz matt milk matt	[.096]
C nerz milk	[.095]	G schwarz-matt black matt	[.092]
C nickel matt satin nickel	[.036]	G weiß-matt white matt	[.052]
D edelmessing sunshine	[.040]	H bronze bronze	[.011]
D platin platinum	[.065]	I gold gold	[.020]
E edelmess.matt sunshine matt	[.041]	L roségold rosegold	[.022]
E gold matt gold matt	[.021]	L roségold matt rosegold matt	[.023]

	649.15.340 Waschtisch-Tassensiphon 1 1/4" <ul style="list-style-type: none"> schwere Ausführung Rosette Abgangsrohr ø 32 mm Tauchrohrlänge 165 mm 	Washbasin cupped siphon trap 1 1/4" <ul style="list-style-type: none"> heavy brass escutcheon outlet tube ø 32 mm dip pipe 165 mm 	A	B	C	D	E
			195,-	296,-	368,-	429,-	568,-
			F	G	H	I	L
			498,-	378,-	539,-	686,-	832,-

	649.15.330 Bidet-Tassensiphon 1 1/4" <ul style="list-style-type: none"> Rosette Abgangsrohr ø 32 mm 	Bidet cupped siphon trap 1 1/4" <ul style="list-style-type: none"> escutcheon outlet tube ø 32 mm 	A	B	C	D	E
			98,-	166,-	276,-	332,-	472,-
			F	G	H	I	L
			399,-	364,-	508,-	648,-	796,-

Badewanne, Stand-Batterien | Bath tub mixer sets, deck mount

	603.40.100 4-Loch Wannenfüll- u. Brausebatterie 1/2" für Standmontage <ul style="list-style-type: none"> Ausladung 220 mm; Höhe 188 mm 2 Seitenrandventile mit keramischen Oberteilen 1/2" Metall-Brauseschlauch 2000 mm Metall-Handbrause mit Anti-Kalk-System und Rückflussverhinderer 	Tub/shower mixer set 1/2" deck mount <ul style="list-style-type: none"> spout projection 220mm; height 188 mm 2 side valves, ceramic internal upper parts 1/2" metal shower hose 2000 mm metal hand shower with anticalc. system and backflow preventer 	A	B	C	D	E
			1.865,-	2.242,-	2.794,-	3.144,-	3.407,-
			F	G	H	I	L
			3.319,-	2.387,-	3.330,-	4.104,-	4.348,-

Empfohlen | Recommended

	649.40.160 Montageplatte, komplett <ul style="list-style-type: none"> für 4-Loch Armaturen Druckschläuche 1/2" x 1/2" x 600 mm empfohlen: Schlauchkastensystem siehe Kapitel "Serienübergreifendes" 	Assembly plate, complete <ul style="list-style-type: none"> for deck mounted tub/shower mixer pressure hoses 1/2"x 1/2" x 600 mm recommended: system with hose box see chapter "universal products" 	A				
			308,-				

	600.11.100 Wand-Wanneneinlauf 3/4" <ul style="list-style-type: none"> Ausladung 175 mm Steckanschluß-Montage 	Tub wall spout 3/4" <ul style="list-style-type: none"> spout projection 175 mm special concealed wall attachment 	A	B	C	D	E
			729,-	799,-	864,-	916,-	1.124,-
			F	G	H	I	L
			1.014,-	896,-	970,-	1.393,-	1.564,-

Badewanne, Aufputz-Batterien | Bath tub mixer sets, exposed

	603.20.100 Aufputz Wannenfüll- und Brausebatterie 1/2", mit Garnitur <ul style="list-style-type: none"> Ausladung 128 mm 2 keramische Oberteile 1/2" 	Exposed tub/shower mixer 1/2", incl. shower set <ul style="list-style-type: none"> spout projection 128 mm 2 ceramic internal upper parts 1/2" 	A	B	C	D	E
			821,-	1.182,-	1.427,-	1.605,-	1.892,-
			F	G	H	I	L
			1.760,-	1.444,-	1.796,-	2.166,-	3.172,-

Dusche, Aufputz-Batterien | Shower mixer sets, exposed

	603.20.200 Brausebatterie 1/2" für Aufputzmontage <ul style="list-style-type: none"> 2 keramische Oberteile 1/2" Brauseabgang unten 1/2" 	Exposed shower mixer 1/2" <ul style="list-style-type: none"> 2 ceramic internal upper parts 1/2" bottom discharge 1/2" 	A	B	C	D	E
			471,-	548,-	699,-	785,-	924,-
			F	G	H	I	L
			862,-	891,-	1.154,-	1.076,-	2.184,-

MINARETT

Maßzeichnungen unter www.joerger.de - Menü SERVICE.
 Technical specifications under www.joerger.de - menu SERVICE.

A chrom chrome	[.000]	E platin matt platinum matt	[.066]
B silbernickel polished nickel	[.035]	F nerz matt mink matt	[.096]
C nerz mink	[.095]	G schwarz-matt black matt	[.092]
C nickel matt satin nickel	[.036]	G weiß-matt white matt	[.052]
D edelmessing sunshine	[.040]	H bronze bronze	[.011]
D platin platinum	[.065]	I gold gold	[.020]
E edelmess.matt sunshine matt	[.041]	L roségold rosegold	[.022]
E gold matt gold matt	[.021]	L roségold matt rosegold matt	[.023]

603.20.410 – Aufputz Set mit Steigrohr | Exposed set with shower system





	649.13.920 Regenbrause ½", ø 200 mm ■ Ausführung ganz in Metall ■ mit Kugelgelenk ■ Anti-Kalk-System	Rain shower head ½", ø 200 mm ■ full metal body ■ with ball joint ■ with anticalcareous system	A	B	C	D	E
			260,-	619,-	824,-	895,-	1.268,-
			F	G	H	I	L
			1.085,-	821,-	1.098,-	1.389,-	2.189,-
	649.20.280 Steigrohr, Umstellung, Wandarm ■ zum Anschluß an die Brausebatterie ■ Ausladung Wandarm 360 - 380 mm ■ in der Neigung und Höhe verstellbare Brausehalterung	Supply pipe, diverter, wall bracket ■ to connect the exposed shower mixer ■ projection wall bracket 360-380 mm ■ fitting for handshower adjustable in height and inclination	A	B	C	D	E
		589,-	932,-	1.198,-	1.362,-	1.741,-	
		F	G	H	I	L	
		1.599,-	1.318,-	1.649,-	1.895,-	2.529,-	
	600.13.700 Brausegarnitur ■ Metall-Handbrause, Brauseschlauch	Shower combination ■ hand shower, metal shower hose	A	B	C	D	E
		369,-	449,-	551,-	608,-	750,-	
		F	G	H	I	L	
		695,-	734,-	1.019,-	844,-	1.499,-	
	603.20.210 Aufputz-Brausebatterie ½" ■ Brauseabgang oben ¾"	Exposed shower mixer ½" ■ top discharge ¾"	A	B	C	D	E
		471,-	545,-	699,-	785,-	924,-	
		F	G	H	I	L	
		862,-	889,-	1.154,-	1.076,-	2.181,-	
	603.20.250 Brausethermostat ½" für Aufputzmontage ■ Sicherheitssperre bei 38° C ■ Keramik-Innenoberteil ½" ■ Brauseabgang unten ½"	Exposed shower thermostat ½" ■ heat scale, locking device at 38° C ■ ceramic cartridge ½" ■ bottom discharge ½"	A	B	C	D	E
		1.126,-	1.530,-	1.697,-	1.819,-	2.459,-	
		F	G	H	I	L	
		2.199,-	1.788,-	2.205,-	2.758,-	3.246,-	

603.20.460 – Aufputz Set mit Steigrohr | Exposed set with shower system



	649.13.920 Regenbrause ½", ø 200 mm ■ Ausführung ganz in Metall ■ mit Kugelgelenk ■ Anti-Kalk-System	Rain shower head ½", ø 200 mm ■ full metal body ■ with ball joint ■ with anticalcareous system	A	B	C	D	E
			260,-	619,-	824,-	895,-	1.268,-
			F	G	H	I	L
			1.085,-	821,-	1.098,-	1.389,-	2.189,-
	649.20.280 Steigrohr, Umstellung, Wandarm ■ zum Anschluß an die Brausebatterie ■ Ausladung Wandarm 360 - 380 mm ■ in der Neigung und Höhe verstellbare Brausehalterung	Supply pipe, diverter, wall bracket ■ to connect the exposed shower mixer ■ projection wall bracket 360-380 mm ■ fitting for handshower adjustable in height and inclination	A	B	C	D	E
		589,-	932,-	1.198,-	1.362,-	1.741,-	
		F	G	H	I	L	
		1.599,-	1.318,-	1.649,-	1.895,-	2.529,-	
	600.13.700 Brausegarnitur ■ Metall-Handbrause, Brauseschlauch	Shower combination ■ hand shower, metal shower hose	A	B	C	D	E
		369,-	449,-	551,-	608,-	750,-	
		F	G	H	I	L	
		695,-	734,-	1.019,-	844,-	1.499,-	
	603.20.260 Brausethermostat ½" für Aufputzmontage ■ Brauseabgang oben ¾"	Exposed shower thermostat ½" ■ top discharge ¾"	A	B	C	D	E
		1.174,-	1.578,-	1.745,-	1.867,-	2.507,-	
		F	G	H	I	L	
		2.247,-	1.836,-	2.253,-	2.806,-	3.294,-	

A chrom chrome	[.000]	E platin matt platinum matt	[.066]
B silbernickel polished nickel	[.035]	F nerz matt milk matt	[.096]
C nerz milk	[.095]	G schwarz-matt black matt	[.092]
C nickel matt satin nickel	[.036]	G weiß-matt white matt	[.052]
D edelmessing sunshine	[.040]	H bronze bronze	[.011]
D platin platinum	[.065]	I gold gold	[.020]
E edelmess.matt sunshine matt	[.041]	L roségold rosegold	[.022]
E gold matt gold matt	[.021]	L roségold matt rosegold matt	[.023]



Unterputz-Thermostate 1/2" | Wall thermostats, concealed 1/2"

	600.40.380 Unterputz-Thermostat 1/2" mit Mengenregulierung, Fertigmontageset	Concealed wall thermostat 1/2" <u>with</u> flow control, assembly set	A	B	C	D	E
	<ul style="list-style-type: none"> manuelle, keramische Umstellung Wanne/Brause, druckunabhängig mit Sicherheitseinrichtung Durchflussrate 20,4 l/min bei 3 bar 	<ul style="list-style-type: none"> manual, ceramic diverter tub/shower for pressure-independent function with safety device flow rate 20,4 l/min at 3 bar 	1.083,-	1.242,-	1.539,-	1.578,-	1.877,-
Variante Alternative			F	G	H	I	L
			1.785,-	1.372,-	1.804,-	2.049,-	2.422,-
	600.40.360 Unterputz-Thermostat 1/2" mit Mengenregulierung, Fertigmontageset	Concealed wall thermostat 1/2" <u>with</u> flow control, assembly set	A	B	C	D	E
	<ul style="list-style-type: none"> ohne Umstellung mit integrierter keramischer Mengenregulierung Durchflussrate 20,4 l/min bei 3 bar 	<ul style="list-style-type: none"> without diverter with integrated ceramic cartridge for volume control flow rate 20,4 l/min at 3 bar 	1.048,-	1.229,-	1.503,-	1.544,-	1.841,-
Variante Alternative			F	G	H	I	L
			1.775,-	1.362,-	1.768,-	2.013,-	2.412,-
	600.40.460 Unterputz-Thermostat 1/2" ohne Mengenregulierung, Fertigmontageset	Concealed wall thermostat 1/2" <u>without</u> flow control, assembly set	A	B	C	D	E
	<ul style="list-style-type: none"> Funktionseinheit ohne Umstellung und ohne Absperrung Durchflussrate 25,8 l/min bei 3 bar 	<ul style="list-style-type: none"> Functional unit <u>without</u> diverter and <u>without</u> shut-off flow rate 25,8 l/min at 3 bar 	884,-	984,-	1.246,-	1.276,-	1.548,-
Benötigt Required			F	G	H	I	L
			1.431,-	1.051,-	1.488,-	1.707,-	1.919,-
	649.40.360 Unterputz-Einbaubox 1/2"	Concealed wall box 1/2"	A				
	<ul style="list-style-type: none"> zu Fertigmontageset 600.40.360, 600.40.380 und 600.40.460 für Nass- und Trockenbau geeignet 	<ul style="list-style-type: none"> for assembly set 600.40.360, 600.40.380 and 600.40.460 for wetwall and drywall construction 	168,-				

Unterputz-Thermostat 3/4" | Wall thermostat, concealed 3/4"

	600.40.560 Unterputz-Thermostat 3/4" ohne Mengenregulierung,	Concealed wall thermostat 3/4" <u>without</u> flow control,	A	B	C	D	E
	<ul style="list-style-type: none"> serienbezogener Temperiergriff Sicherheitsperre bei 38° C 	<ul style="list-style-type: none"> design handle for temp. control locking device at 38° C 	608,-	848,-	1.071,-	1.114,-	1.424,-
Benötigt Required			F	G	H	I	L
			1.304,-	719,-	1.542,-	1.660,-	1.865,-
	649.40.555 Unterputz-Einbaukörper 3/4"	Concealed thermostat body 3/4"	A				
	<ul style="list-style-type: none"> zu Fertigmontageset 600.40.555 Kartusche mit Schmutzfangsieben für Nass- und Trockenbau geeignet Durchflussrate 64,2 l/min bei 3 bar ohne Absperrung 	<ul style="list-style-type: none"> for assembly set 600.40.555 cartridge with filter screens for wetwall and drywall construction flow rate 64,2 l/min at 3 bar without shut-off 	1.636,-				

Unterputz-Umstellung und Ventile | Diverter and valves concealed

	603.40.650 Unterputz 3-Wege Umstellung Fertigmontageset	Concealed 3-position diverter assembly set	A	B	C	D	E
	<ul style="list-style-type: none"> Griff, Hülse, Schubrosette 	<ul style="list-style-type: none"> handle, socket, escutcheon 	254,-	317,-	356,-	400,-	470,-
			F	G	H	I	L
			438,-	385,-	474,-	558,-	674,-
	649.40.600 Unterputz 3-Wege Umstellung 1/2" Einbaukörper	Concealed 3-position diverter 1/2" diverter body	A				
	<ul style="list-style-type: none"> zu Fertigmontageset 600.40.650 und 603.40.650 	<ul style="list-style-type: none"> for assembly set 600.40.650 and 603.40.650 	236,-				

MINARETT

Maßzeichnungen unter www.joerger.de - Menü SERVICE.
 Technical specifications under www.joerger.de - menu SERVICE.

A chrom chrome	[.000]	E platin matt platinum matt	[.066]
B silbernickel polished nickel	[.035]	F nerz matt mink matt	[.096]
C nerz mink	[.095]	G schwarz-matt black matt	[.092]
C nickel matt satin nickel	[.036]	G weiß-matt white matt	[.052]
D edelmessing sunshine	[.040]	H bronze bronze	[.011]
D platin platinum	[.065]	I gold gold	[.020]
E edelmess.matt sunshine matt	[.041]	L roségold rosegold	[.022]
E gold matt gold matt	[.021]	L roségold matt rosegold matt	[.023]

Unterputz-Thermostat/Ventil-Modul | Concealed thermostatic/wall-valve modul



603.60.432	Unterputz-Ventil-Modul Fertigmontageset	Concealed wall-valve-modul assembly set
	<ul style="list-style-type: none"> Griff Rosette 	<ul style="list-style-type: none"> design handle escutcheon

A	B	C	D	E
254,-	332,-	356,-	400,-	470,-
F	G	H	I	L
448,-	338,-	453,-	558,-	631,-

Benötigt | Required



649.20.610	Unterputz-Ventil-Modul, 1-fach	Concealed wall-valve-modul, single
	<ul style="list-style-type: none"> 1x Spindelventil 3/4", rechtsschließend mit keram. Scheiben 2 Abgänge 1/2", je 1x rechts/links möglich, gleichzeitig benutzbar 	<ul style="list-style-type: none"> 1x spindle valve 3/4", clockwise closure with ceramic discs 2 outlets 1/2", each 1x right/left possible, simultaneously usable

A				
229,-				



649.20.620	Unterputz-Ventil-Modul, 2-fach	Concealed wall-valve-modul, double
	<ul style="list-style-type: none"> 2x Spindelventil 3/4", rechtsschließend mit keram. Scheiben 4 Abgänge 1/2", je 2x rechts/links möglich, gleichzeitig benutzbar im Verbund maßgenaue Montage erweiterbar mit 649.20.610 	<ul style="list-style-type: none"> 2x spindle valve 3/4", clockwise closure with ceramic discs 4 outlets 1/2", each 2x right/left possible, simultaneously usable precise assembly due to composite expandable with 649.20.610

A				
458,-				



649.20.630	Unterputz-Ventil-Modul, 3-fach	Concealed wall-valve-modul, triple
	<ul style="list-style-type: none"> 3x Spindelventil 3/4", rechtsschließend mit keram. Scheiben 6 Abgänge 1/2", je 3x rechts/links möglich, gleichzeitig benutzbar im Verbund maßgenauen Montage erweiterbar mit 649.20.610 	<ul style="list-style-type: none"> 3x spindle valve 3/4", clockwise closure with ceramic discs 6 outlets 1/2", each 3x right/left possible, simultaneously usable precise assembly due to composite expandable with 649.20.610

A				
686,-				



600.40.460	Unterputz-Thermostat 1/2" ohne Mengenregulierung, Fertigmontageset	Concealed wall thermostat 1/2" <u>without</u> flow control, assembly set
	<ul style="list-style-type: none"> Funktionseinheit <u>ohne</u> Umstellung und <u>ohne</u> Absperrung Durchflußrate 25,8 l/min bei 3 bar 	<ul style="list-style-type: none"> Functional unit <u>without</u> diverter and <u>without</u> shut-off flow rate 25,8 l/min at 3 bar

A	B	C	D	E
884,-	984,-	1.246,-	1.276,-	1.548,-
F	G	H	I	L
1.431,-	1.051,-	1.488,-	1.707,-	1.919,-

Benötigt | Required



649.20.612	Anschlußadapter 1/2"	Connection adapter 1/2"
	<ul style="list-style-type: none"> Anschlußadapter, Abschlußstopfen passend zu Einbaubox 649.40.360 	<ul style="list-style-type: none"> connection adapter, end plug matching to wall box 649.40.360

A				
122,-				



649.40.360	Unterputz-Einbaubox 1/2"	Concealed wall box 1/2"
	<ul style="list-style-type: none"> zu Fertigmontageset 600.40.460 für Nass- und Trockenbau geeignet 	<ul style="list-style-type: none"> for assembly set 600.40.460 for wetwall and drywall construction

A				
168,-				



600.40.560	Unterputz-Thermostat 3/4" ohne Mengenregulierung, serienbezogener Temperiergriff	Concealed wall thermostat 3/4" <u>without</u> flow control,
	<ul style="list-style-type: none"> Sicherheitsperre bei 38° C 	<ul style="list-style-type: none"> design handle for temp. control locking device at 38° C

A	B	C	D	E
608,-	848,-	1.071,-	1.114,-	1.424,-
F	G	H	I	L
1.304,-	719,-	1.542,-	1.660,-	1.865,-

Benötigt | Required



649.20.634	Anschlußadapter 3/4"	Connection adapter 3/4"
	<ul style="list-style-type: none"> Anschlußadapter, Abschlußstopfen passend zu Einbaukörper 649.40.555 	<ul style="list-style-type: none"> connection adapter, end plug matching to wall body 649.40.555

A				
146,-				



649.40.555	Unterputz-Einbaukörper 3/4"	Concealed thermostat body 3/4"
	<ul style="list-style-type: none"> zu Fertigmontageset 600.40.555 Kartusche mit Schmutzfangsieben für Nass- und Trockenbau geeignet Durchflußrate 64,2 l/min bei 3 bar <u>ohne</u> Absperrung 	<ul style="list-style-type: none"> for assembly set 600.40.555 cartridge with filter screens for wetwall and drywall construction flow rate 64,2 l/min at 3 bar <u>without</u> shut-off

A				
1.636,-				

MINARETT

Maßzeichnungen unter www.joerger.de - Menü SERVICE.
 Technical specifications under www.joerger.de - menu SERVICE.

A chrom chrome	[.000]	E platin matt platinum matt	[.066]
B silbernickel polished nickel	[.035]	F nerz matt mink matt	[.096]
C nerz mink	[.095]	G schwarz-matt black matt	[.092]
C nickel matt satin nickel	[.036]	G weiß-matt white matt	[.052]
D edelmessing sunshine	[.040]	H bronze bronze	[.011]
D platin platinum	[.065]	I gold gold	[.020]
E edelmess.matt sunshine matt	[.041]	L roségold rosegold	[.022]
E gold matt gold matt	[.021]	L roségold matt rosegold matt	[.023]



603.50.234 Unterputz-Ventil, Fertigmontageset
 ■ Griff, Hülse, Schubrosette

Concealed wall valve, assembly set
 ■ handle, socket, escutcheon

A	B	C	D	E
207,-	257,-	290,-	326,-	384,-
F	G	H	I	L
360,-	341,-	434,-	455,-	633,-

Benötigt | Required



649.20.340 Unterputz-Ventil 1/2", Einbaukörper
 ■ rechtsschließend, ker. Scheiben

Concealed wall valve 1/2", body
 ■ clockwise closure, ceramic discs

A	B	C	D	E
62,-				



649.20.345 Unterputz-Ventil 1/2", Einbaukörper
 ■ linksschließend, ker. Scheiben

Concealed wall valve 1/2", body
 ■ counter-clockwise closure, cer. discs

A	B	C	D	E
106,-				



649.20.440 Unterputz-Ventil 3/4", Einbaukörper
 ■ rechtsschließend, ker. Scheiben

Concealed wall valve 3/4", body
 ■ clockwise closure, ceramic discs

649.20.445 Unterputz-Ventil 3/4", Einbaukörper
 ■ linksschließend, ker. Scheiben

Concealed wall valve 3/4", body
 ■ counter-clockwise closure, cer. discs

Brausen | Showers



603.13.310 Duschgarnitur, komplett
 ■ Wandrohr 780 mm, mit Schieber
 ■ Metall-Handbrause mit Anti-Kalk-System und Rückflussverhinderer
 ■ Metall-Brauseschlauch 1750 mm, beidseitig mit drehbarem Konus

Shower bar set, complete
 ■ wall bar 780 mm, with slider
 ■ metal hand shower with anticalc. system and backflow preventer
 ■ metal shower hose 1750 mm, both sides with turning cone

A	B	C	D	E
1.008,-	1.642,-	1.699,-	1.759,-	2.142,-
F	G	H	I	L
1.974,-	1.079,-	2.324,-	2.386,-	3.648,-



600.13.200 Schlauchbrausegarnitur
 ■ Wandanschlußbogen 1/2"
 ■ Wand-Brausehalter
 ■ Metall-Handbrause mit Anti-Kalk-System und Rückflussverhinderer
 ■ Metall-Brauseschlauch 1500 mm, beidseitig mit drehbarem Konus

Shower combination
 ■ Wall elbow connection 1/2"
 ■ Wall fitting for hand shower
 ■ metal hand shower with anticalc. system and backflow preventer
 ■ flexible metal shower hose 1500 mm, both sides with turning cone

A	B	C	D	E
592,-	727,-	809,-	910,-	1.072,-
F	G	H	I	L
946,-	948,-	1.259,-	1.139,-	1.784,-



600.13.150 Wandanschlußbogen 1/2", ohne Haken
 ■ Brauseabgang 1/2"
 ■ mit Rückflussverhinderer, Rosette

Wall elbow connection 1/2", without cradle
 ■ discharge 1/2"
 ■ with backflow preventer, escutcheon

A	B	C	D	E
99,-	134,-	139,-	157,-	185,-
F	G	H	I	L
169,-	158,-	198,-	208,-	314,-



649.13.210 Wand-Brausehalter

Wall fitting for hand shower

A	B	C	D	E
178,-	214,-	266,-	287,-	337,-
F	G	H	I	L
299,-	256,-	325,-	374,-	459,-

MINARETT

Maßzeichnungen unter www.joerger.de - Menü SERVICE.
 Technical specifications under www.joerger.de - menu SERVICE.

A chrom chrome	[.000]	E platin matt platinum matt	[.066]
B silbernickel polished nickel	[.035]	F nerz matt milk matt	[.096]
C nerz milk	[.095]	G schwarz-matt black matt	[.092]
C nickel matt satin nickel	[.036]	G weiß-matt white matt	[.052]
D edelmessing sunshine	[.040]	H bronze bronze	[.011]
D platin platinum	[.065]	I gold gold	[.020]
E edelmess.matt sunshine matt	[.041]	L roségold rosegold	[.022]
E gold matt gold matt	[.021]	L roségold matt rosegold matt	[.023]

	600.13.237 Hygienebrausegarnitur <ul style="list-style-type: none"> Wandbrausehalter und -anschlußbogen 1/2", Schubrosette Hygienebrause, klassisch (649.13.338), komplett aus Metall einstrahlig, Bedienung über Druckhebel Metall-Brauseschlauch 1250 mm 	Ablution spray combination <ul style="list-style-type: none"> wall fitting and elbow connection 1/2" spray handshower, classical (649.13.338), completely metal one jet, push-lever operation flexible metal shower hose 1250 mm 	A	B	C	D	E
			332,-	404,-	645,-	676,-	893,-
			F	G	H	I	L
			772,-	669,-	998,-	1.081,-	1.529,-

	607.20.237 1-Hand Batterie 1/2" für Hygiene-Brause, Fertigmontageset <ul style="list-style-type: none"> Rosette, Griff mit Hebelgriff 	Concealed single lever 1/2" for ablution spray, assembly set <ul style="list-style-type: none"> escutcheon, handle with lever handle 	A	B	C	D	E
			296,-	378,-	490,-	552,-	649,-
			F	G	H	I	L
			594,-	534,-	612,-	754,-	811,-

Benötigt | Required

	649.20.237 Unterputz 1-Hand Batterie 1/2", Einbaukörper <ul style="list-style-type: none"> Kartusche mit keramischen Scheiben zu Fertigmontageset 601.20.237 	Single lever mixer 1/2", concealed body <ul style="list-style-type: none"> cartridge with ceramic discs for assembly set 601.20.237 	A	B	C	D	E
			125,-	169,-	208,-	229,-	268,-
			F	G	H	I	L
			249,-	224,-	258,-	329,-	396,-

	649.13.615 Stachelkopfbrause 1/2" <ul style="list-style-type: none"> ø 230 mm, 75 Düsen Ausführung ganz in Metall Anti-Kalk-System Brausekopf schwenkbar ohne Wandarm 	Body spray shower head 1/2" <ul style="list-style-type: none"> ø 230 mm, 75 jets full metal body anticalcareous system swivel shower head without wall bracket 	A	B	C	D	E
			969,-	1.232,-	1.359,-	1.416,-	1.659,-
			F	G	H	I	L
			1.496,-	1.399,-	1.718,-	2.262,-	2.739,-

Empfohlen | Recommended

	649.13.625 Wandarm 1/2" <ul style="list-style-type: none"> Ausladung 162 mm 	Wall bracket 1/2" <ul style="list-style-type: none"> projection 162 mm 	A	B	C	D	E
			126,-	145,-	171,-	189,-	250,-
			F	G	H	I	L
			229,-	192,-	296,-	286,-	499,-







	649.13.519 Seitenbrause 1/2" <ul style="list-style-type: none"> Rosette ø 130 mm, Wandmontage Brausekopf schwenkbar, 20° Anti-Kalk-System Ausführung Kunststoff 	Body spray side shower 1/2" <ul style="list-style-type: none"> escutcheon ø 130 mm, wall assembly swivel shower head, 20° anticalcareous system plastic 	A	B	C	D	E
			167,-	326,-	385,-	399,-	542,-
			F	G	H	I	L
			496,-	376,-	472,-	634,-	949,-

MINARETT

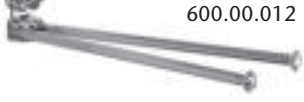
Maßzeichnungen unter www.joerger.de - Menü SERVICE.
 Technical specifications under www.joerger.de - menu SERVICE.

A chrom chrome	[.000]	E platin matt platinum matt	[.066]
B silbernickel polished nickel	[.035]	F nerz matt milk matt	[.096]
C nerz milk	[.095]	G schwarz-matt black matt	[.092]
C nickel matt satin nickel	[.036]	G weiß-matt white matt	[.052]
D edelmessing sunshine	[.040]	H bronze bronze	[.011]
D platin platinum	[.065]	I gold gold	[.020]
E edelmess.matt sunshine matt	[.041]	L roségold rosegold	[.022]
E gold matt gold matt	[.021]	L roségold matt rosegold matt	[.023]

Accessoires für Handtücher | Accessories for towels

	600.00.002 Handtuchhalter, doppelt ■ Rohre schwenkbar, ca. 430 mm	Double towel bar ■ swivelling bars, approx. 430 mm	A	B	C	D	E
			447,-	632,-	677,-	761,-	931,-
	600.00.012 Handtuchhalter, doppelt ■ verkürzt, ca. 300 mm	Double towel bar ■ shortened, approx. 300 mm	F	G	H	I	L
			850,-	693,-	828,-	1.143,-	1.281,-
	600.00.047 Handtuchring ■ ø ca. 190 mm ■ geschlossene Ausführung	Towel ring ■ ø approx. 190 mm ■ closed version	A	B	C	D	E
			268,-	368,-	427,-	481,-	584,-
			F	G	H	I	L
			515,-	445,-	518,-	686,-	873,-
	600.00.022 Handtuchhaken	Robe hanger	A	B	C	D	E
			128,-	170,-	199,-	224,-	274,-
			F	G	H	I	L
			256,-	149,-	229,-	332,-	345,-
	600.00.040 Badetuchhalter ■ ca. 800 mm	Bath towel bar ■ approx. 800 mm	A	B	C	D	E
			492,-	729,-	778,-	814,-	1.018,-
			F	G	H	I	L
			928,-	700,-	952,-	1.112,-	1.767,-
	600.00.031 Wannengriff ■ ca. 300 mm	Tub handle ■ approx. 300 mm	A	B	C	D	E
			420,-	588,-	608,-	634,-	760,-
			F	G	H	I	L
			701,-	606,-	718,-	916,-	1.174,-
	600.00.104 Gästehandtuchkorb, eckig ■ mit Ablage ■ Korbgröße 260 x 150 x 190 mm	Guest towel basket, angular ■ with shelf ■ basket size 260 x 150 x 190 mm	A	B	C	D	E
			415,-	479,-	624,-	673,-	816,-
			F	G	H	I	L
			744,-	642,-	1.049,-	896,-	1.958,-

Accessoires für Waschplatz | Accessories for washstands

	600.00.007 Seifenhalter, komplett ■ Seifenschale aus Kristallglas	Soap dish holder, complete ■ crystal glass dish	A	B	C	D	E
			347,-	466,-	538,-	605,-	734,-
			F	G	H	I	L
			684,-	478,-	615,-	890,-	968,-
	700.00.307 Seifenschale, lose	Glass dish, separate	A				
			99,-				

MINARETT

Maßzeichnungen unter www.joerger.de - Menü SERVICE.
 Technical specifications under www.joerger.de - menu SERVICE.

A chrom chrome	[.000]	E platin matt platinum matt	[.066]
B silbernickel polished nickel	[.035]	F nerz matt mink matt	[.096]
C nerz mink	[.095]	G schwarz-matt black matt	[.092]
C nickel matt satin nickel	[.036]	G weiß-matt white matt	[.052]
D edelmessing sunshine	[.040]	H bronze bronze	[.011]
D platin platinum	[.065]	I gold gold	[.020]
E edelmess.matt sunshine matt	[.041]	L roségold rosegold	[.022]
E gold matt gold matt	[.021]	L roségold matt rosegold matt	[.023]

	600.00.105 Schwammkorb ■ rechteckig, 260 x 130 mm	Sponge basket ■ rectangular, 260 x 130 mm	A	B	C	D	E
			325,-	484,-	539,-	572,-	739,-
			F	G	H	I	L
			666,-	563,-	749,-	832,-	1.258,-

	600.00.106 Eckschwammkorb ■ 195 x 195 mm	Corner sponge basket ■ 195 x 195 mm	A	B	C	D	E
			296,-	495,-	525,-	548,-	682,-
			F	G	H	I	L
			622,-	596,-	708,-	757,-	1.200,-

	600.00.006 Lotionsspender, komplett	Soap dispenser, complete	A	B	C	D	E
			329,-	522,-	552,-	574,-	695,-
			F	G	H	I	L
			610,-	581,-	642,-	845,-	970,-

	713.00.306 Lotionsspenderglas, lose ■ seidenmatt, ohne Pumpe	Soap dispenser glass, separate ■ frosted, without pump	A				
			78,-				

	600.00.036 Glashalter, komplett ■ Glas aus Kristallglas	Tumbler holder, complete ■ crystal glass tumbler	A	B	C	D	E
			345,-	485,-	534,-	601,-	728,-
			F	G	H	I	L
			699,-	494,-	612,-	886,-	979,-

	700.00.336 Mundglas, lose	Glass tumbler, separate	A				
			96,-				

	600.00.009 Ablage, 600 mm ■ Glasplatte aus Kristallglas	Shelf holder with glass, 600 mm ■ crystal glass shelf	A	B	C	D	E
			566,-	694,-	713,-	799,-	943,-
			F	G	H	I	L
			881,-	808,-	838,-	1.153,-	1.159,-

Accessoires für WC-Bereich | Accessories for w.c. area

	600.00.014 Papierhalter ■ mit Deckel	Toilet paper roll holder ■ with lid	A	B	C	D	E
			408,-	470,-	645,-	726,-	890,-
			F	G	H	I	L
			860,-	533,-	784,-	1.089,-	1.182,-

	600.00.015 Reserve-Papierhalter	Spare toilet paper roll holder	A	B	C	D	E
			313,-	428,-	485,-	545,-	661,-
			F	G	H	I	L
			635,-	407,-	558,-	802,-	842,-

MINARETT

Maßzeichnungen unter www.joerger.de - Menü SERVICE.
 Technical specifications under www.joerger.de - menu SERVICE.

A chrom chrome	[.000]	E platin matt platinum matt	[.066]
B silbernickel polished nickel	[.035]	F nerz matt mink matt	[.096]
C nerz mink	[.095]	G schwarz-matt black matt	[.092]
C nickel matt satin nickel	[.036]	G weiß-matt white matt	[.052]
D edelmessing sunshine	[.040]	H bronze bronze	[.011]
D platin platinum	[.065]	I gold gold	[.020]
E edelmess.matt sunshine matt	[.041]	L roségold rosegold	[.022]
E gold matt gold matt	[.021]	L roségold matt rosegold matt	[.023]



600.00.000 Klosettbürstengarnitur, komplett ■ Glas aus Kristallglas, seidenmatt	Toilet brush holder set, complete ■ crystal glass, frosted	A	B	C	D	E
		474,-	690,-	698,-	766,-	900,-
799.00.300 Bürstenglas, seidenmatt, lose	Brush glass, frosted, separate	A				
		48,-				
650.00.053 Bürstenstange komplett, lose	Brush rod with brush, separate	A	B	C	D	E
		139,-	189,-	215,-	242,-	296,-
799.00.238 Bürstenkopf, lose	Brush, separate	A				
		19,-				

Leuchten und Spiegel | Lamps and mirrors



600.00.061 Wandleuchte, komplett ■ mit Leuchtmittel, 40 W ■ Designvariante FLORALE	Wall lamp, complete ■ light bulb included, 40 W ■ design style FLORALE	A	B	C	D	E
		778,-	848,-	904,-	996,-	1.198,-
700.00.361 Leuchtenglas, lose ■ Leuchtenglas klar	Glass, separate ■ glass clear	A				
		199,-				



649.00.414 Kosmetikspiegel, beleuchtet ■ schwenk- und ausziehbar ■ 3-fache Vergrößerung ■ Direktanschluss ■ Spiegeldurchmesser 185 mm ■ Rahmendurchmesser 250 mm ■ Kalt-, Warm- und Taglicht durch Piezzo-Schalter umschaltbar	Cosmetic mirror, incl. lighting ■ swivelling and extendable ■ magnification 3:1 ■ direct connection ■ mirror diameter 185 mm ■ frame diameter 250 mm ■ cold, warm and day light switchable by Piezzo switch	A	B	C	D	E
		556,-	988,-	1.214,-	1.418,-	1.828,-
		F	G	H	I	L
		1.684,-	1.214,-	1.549,-	2.138,-	2.998,-



JÖRGER ARMATUREN- UND ACCESSOIRESFABRIK GMBH
Seckenheimer Landstraße 270-280 | 68163 Mannheim / Germany | Telefon: +49 621 41097-01 | E-Mail: info@joerger.de
WWW.JOERGER.DE