	<i>oXigen system</i>	Doc.
	"Type C" Universal (O2-SSD-D132) and "B" (O2) in-car chip manual	Pag. 1/ 25



The B2 and C in car chips

This manual is about the third generation of in-car chips from Slot.it. It describes the features, installation and operation of the 'B2' and 'C' type chips. They are based on a multi protocol radio device IC manufactured by Nordic Semiconductors. They are compact devices that require some care in handling and installation.

Important note: these devices come with a protective screen glued to the bottom side of the chip. The screen is there for a specific reason: to protect a very, very tiny device which could easily be damaged, as well as keeping the rest of the circuit safe, as well. Do not remove, or attempt to remove, the screen: such action will immediately invalidate any warranties, no exceptions made.

If a digital slot car chip could speak, it would tell a horror story of a life subject to electrical arcing, vibrations, heat, g-shocks. Please, at least you, the user, be kind to them.

The B2 type chips keep the same footprint and external interface of the B1 chips. A car equipped with a B1 chip can be chipped with B2 unit with minimal effort: the lighting kit and Hall sensors' connectors are compatible.

Type C is a universal chip which can run on most all the digital systems supported by track manufacturers: oXigen, Scalextric SSD, Carrera D132. It is also the smallest of its kind; to reduce its size as much as possible, lighting kit and Hall sensor.

Before we start, a word on warranty.



A "kapton" protective cover is glued to the bottom side of the chip to protect the electronic components. **Don't remove this protection to avoid damage to the chip AND loss of warranty.**

We will not even try to repair a chip returned with no screen or with a damaged one. The screen is there for a reason, so don't remove it, as it protects miniaturized components that may be easily damaged. DO NOT USE hot glue if you plan to remove the chip from the chassis. Use blue-tac (also known as 'patafix' or the likes of it) or double sided tape.

Proper handling of the chip is also required. Chips with missing parts, detached capacitors, hacked pcb, are not covered by warranty.

A valid proof of purchase must be provided as well, so please keep your receipts.

	<i>oXigen system</i>		Doc.
	"Type C" Universal (O2-SSD-D132) and "B" (O2) in-car chip manual		Pag. 2/ 25

AC/DC

The car is propelled by a motor which gets its power from the track. Such current and voltage can either be 'continuous', such as the one coming from a standard battery, or 'alternate', like the power mains.

oXigen systems are preferably powered by DC power. Carrera is DC, too. Scalextric SSD is unique in using AC power.

All oXigen chips are compatible with both AC and DC:

1. if the power on the rails is DC (analog or oXigen track), chips can be either in DC or AC+DC modes. In this latter case, the car will be able to run in both directions, but it will be slightly slower than if it was powered from the DC pad (0.5V loss approximately). This is also always true if the firmware loaded on the chip is the oXigen one.
2. if the rails are powered by a Carrera digital power bases, AND the firmware is the D132 one (i.e.: you are running in Carrera D132 NATIVE mode), the screw must be in the DC mode.
3. if the rails are powered by a Hornby power base or a derivative, the AC setup *must* be used, or the car will not work.

Unless you plan to use the chips on Scalextric SSD, leave them in DC mode, such as they are sold. Keep in mind that, anyway, AC position is compatible with DC mode, but at the expense of some small power loss. Viceversa is not true. To recap: for maximum power, and if system is DC, use DC mode (box stock). For technical reasons, if you try to run on a Carrera D132 with the screw on AC mode, you may experience technical issue

Power base →	oXigen / Analog	SSD	D132
Wires soldered to ↓			
DC pads / screw pos.	OK	NO	OK, unidirectional
AC pads / screw pos.	OK (0.5v loss)	OK	NO

Suggestion: start with the system that you are running the car on: is it analog, Carrera,

	<i>oXigen system</i>	Doc.
	"Type C" Universal (O2-SSD-D132) and "B" (O2) in-car chip manual	Pag. 3/ 25

The 'C' type chip

The type 'C' chip is a compact and powerful device. All what follows applies to type C and C1 devices, except that type C is only compatible with oXigen hardware and is being phased out.

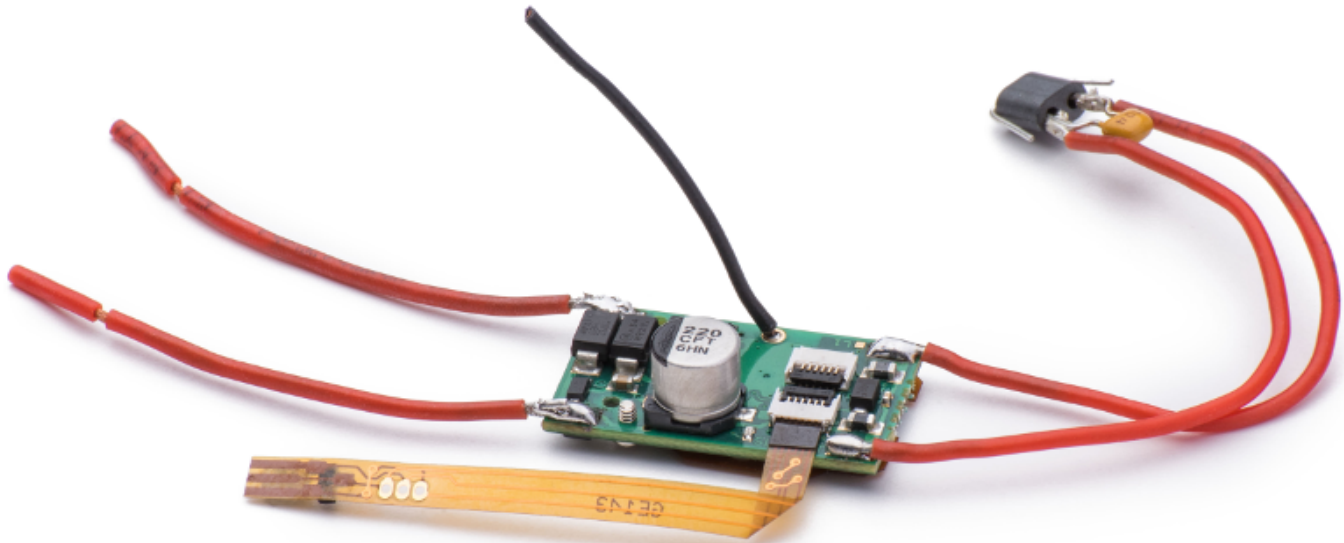

It's a universal unit, being natively compatible with oXigen, Scalextric SSD, and Carrera digital. 'Natively compatible' means that the chip performs like any SSD or Carrera 132 original system once the proper software is loaded. In other words, when appropriately programmed, you can use this chip on either Scalextric SSD, or Carrera D132, as if it was a 'standard' device for the said system.

Known limits: on Carrera, it doesn't support Ghost and Pace car modes. The advanced 'Slot.it Autonomous car', under development, can replace Ghost car for all systems, analog included. Fast pairing will be supported but it is not, currently. Analog mode as defined by Carrera and SSD is also not supported, but the chip works properly on any analog tracks when used with an oXigen compatible controller, provided the track is powered with a fixed voltage.

Important: type C chip can run natively (i.e. as if it was an original D132 or SSD chip) on Carrera and Scalextric digital systems once the appropriate firmware is loaded in the chip. This gives full compatibility, with the D132 exception above. Alternatively, the oXigen firmware has two 'modes' that make a chip with oXigen firmware partly compatible with either digital system.

So please keep in mind the distinction between 'firmware' and 'modes'. In other words, the type C chip can have oXigen firmware supporting the D132 and SSD mode that enable a car to be driven *wirelessly* on a Carrera D132 or SSD track, ignoring all the native D132 or SSD commands that come from the rails. Alternatively, for full compatibility, the specific firmware must be loaded, so that the chip will react to the codes on the rails.

	<i>oXigen system</i>	Doc.
	"Type C" Universal (O2-SSD-D132) and "B" (O2) in-car chip manual	Pag. 4/ 25

AC vs. DC

The car is propelled by a motor which gets its power from the track. Current and voltage can either be 'continuous', such as the one coming from a standard battery, or 'alternate', like the power mains.

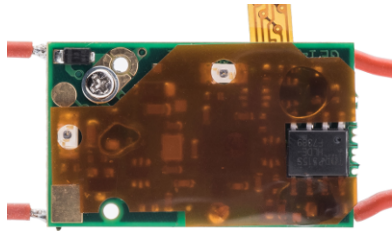

AC mode setup for Scalextric SSD.

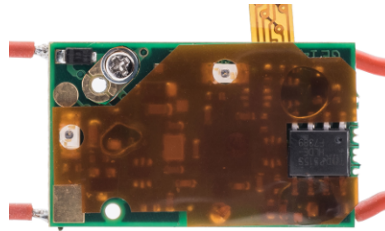

DC mode for Carrera D132 and preferred for oXigen and analog

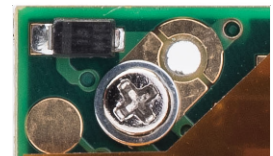
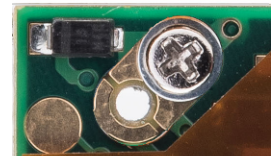

DC mode (top) / AC mode (bottom)

oXigen systems are generally wired to DC power like all analog tracks.. Carrera is DC, too. Scalextric SSD is unique in using AC power. The type C chip can run on all of the above.

The little screw detailed above switches the power input to the chip between DC to AC. F

System ↓	Power →	AC	DC
Carrera D132		X	OK
Scalextric SSD		OK	X
Slot.it oXigen		OK	OK

In DC mode, the power is routed through one diode only, which keeps the voltage loss to a minimum.. The AC mode setup, required to race the car on a Scalextric SSD system, makes it run both ways. For oXigen, either AC or DC can be used, but AC will deliver about 0.5V less to the motor. Carrera needs DC.

Keep in mind that the polarity on Carrera track is opposite to the majority of other slot cars systems. Therefore, it may be necessary to swap wires on the pickup compared to, say, oXigen. Future versions of the chip will come with a polarity inversion optional cable.



Be very careful when changing the position of the screw! A screwdriver slipping from the screws' head and hitting the PCB may damage your chip.

The chip size is smaller than type B. It measures 15*25mm and fits on a Scalextric DPR latch, in which case its double LEDs match the proper position for all of the above said systems, but, due to the dual LED on board, can also be used when rotated 90° in an oXigen or SSD system.

The special DPR latch is available from Slot.it Shapeways online shop as part [S99-S04](#) – also available in 2 pieces unit [S99-S04-2pcs](#), to save you some penny on the unit cost, as Shapeways has a fixed fee per print.

	<i>oXigen system</i>	Doc.
	"Type C" Universal (O2-SSD-D132) and "B" (O2) in-car chip manual	Pag. 5/ 25

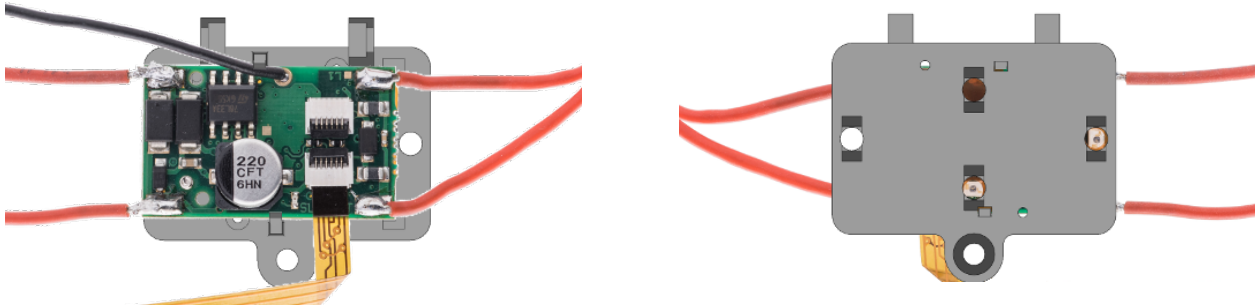

Here is how.

Oxygen and SSD receivers are located in the bottom of the slot of the track. Carrera D132 is located right before the lane changing mechanism, to the left of the rails.

The special SSD latch can be purchased from Slot.it's 3D print shop.

On a DPR ready Scalextric, or PCR chassis, installation is straightforward [1].

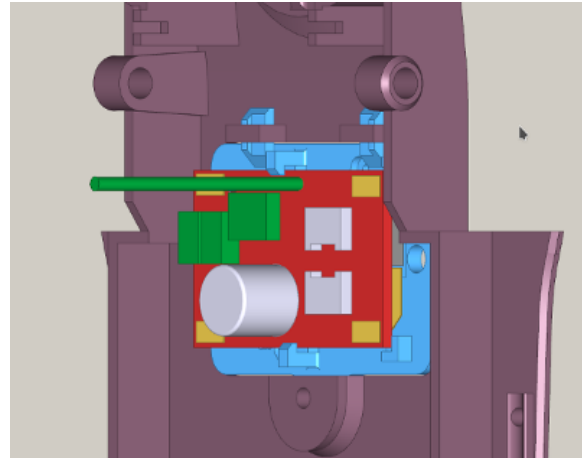
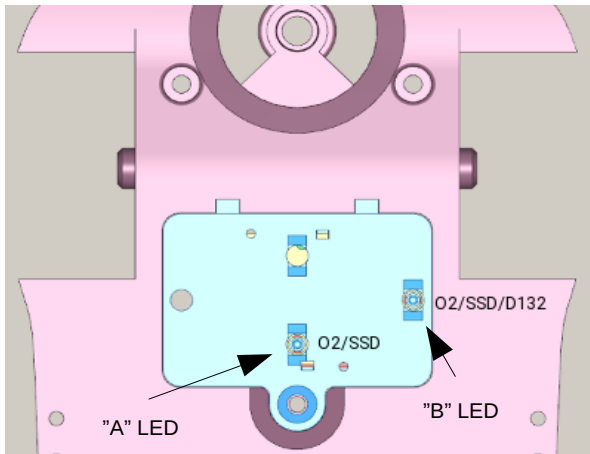

Hardware compatibility: "A" LED is compatible with oXigen and Scalextric SSD lane changers but not with D132. "B" LED is compatible with oXigen, SSD, and Carrera D132 hardware.

What does this mean in practice?

Recent Slot.it models come equipped with a very simple mounting mechanism: make sure that the reference pin on the chassis and the correspondent hole on the circuit are matched:

This design places the chip in the proper position for all systems, when used on a recent Slot.it car.

	oXigen system	Doc. Pag. 6/ 25
"Type C" Universal (O2-SSD-D132) and "B" (O2) in-car chip manual		

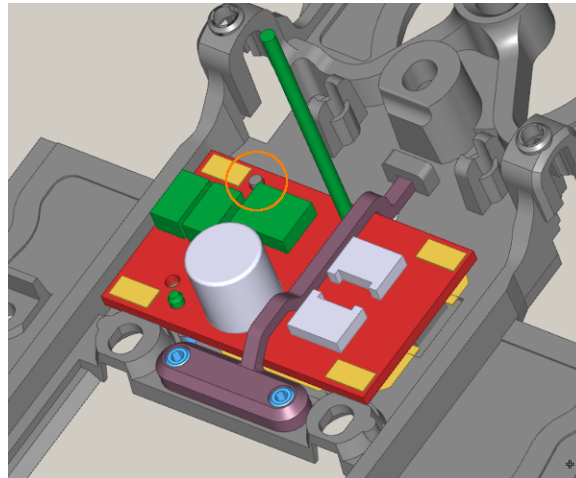

[1] Note that on some very narrow PCR cars such as the BMW E30, it may not be possible to use this chip on the special DPR latch due to dimensional constraints.

There may be cases, however, where an 'inline' mounting of the chip may be useful, especially in older Slot.it cars:

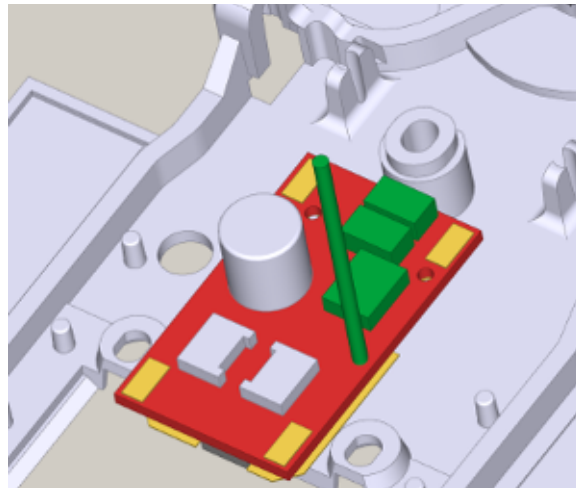

Once the chip is properly placed inside the car chassis, make sure the "B" LED can be seen through the chassis hole which is aligned to the middle of the chassis.

	oXigen system	Doc.
	"Type C" Universal (O2-SSD-D132) and "B" (O2) in-car chip manual	Pag. 7/ 25

The chip also provides extra pads to wire an external additional lane changer LED. There is no need to remove the standard LEDs, which are mounted directly on the board. This is useful if for any reasons if cannot mount the chip so that the LEDs are aligned with the receivers. For example, if you are running on Carrera D132 natively, and alignment of the "B" LED with the D132 receiver is impossible, you may use the wired LED and place it so that it aligns with the D132 receiver

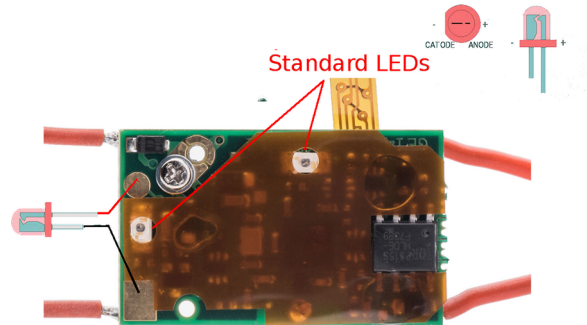

A "kapton" protective cover is glued to the bottom side of the chip to protect the electronic components. **Don't remove this protection to avoid damage to the chip AND loss of warranty.** Did we say this before?

Two connectors are placed on the top of the chip. A flat flexible cable with a unipolar Hall sensor is plugged to the connector on the left. The sensor works as lap and finish line detector, sensing the magnetic field created by magnets that, when placed under the track, delimit the finish line and pit lane. Said Hall sensor must be fixed to the chassis of the car so that it faces down as described in the picture below; otherwise the sensor won't work (unless the magnets are also wrongly placed!).

If you are using the chip on Scalextric SSD or Carrera D132, you can ignore this sensor.

The other connector is for the lighting kit (under development).

Type 'C' comes with a red LED mounted on the top face which blinks according to the following table:

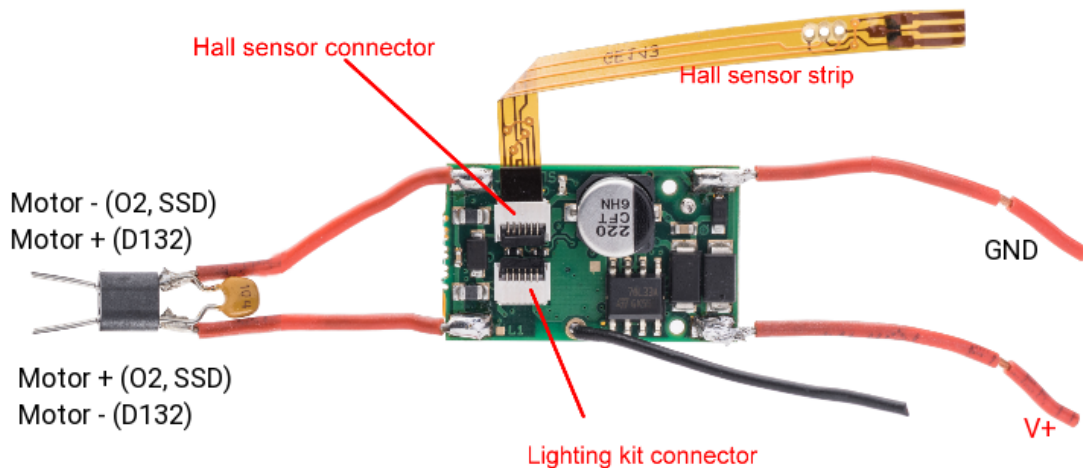

	<i>oXigen system</i>	Doc.
	"Type C" Universal (O2-SSD-D132) and "B" (O2) in-car chip manual	Pag. 8/ 25

Blinking type	Meaning
fixed	power is on, no link
fixed	power is on, UP arrow pressed
quick flashing	linked, no button pressed
off	no power
off	power is on, DOWN arrow pressed

The antenna, which is the 2.5cm long piece of wire coming out from the top of the chip, should be kept vertical, within the realms of possible. It is not recommended to lay the antenna flat down on the chip or close to the motor. It will work, but it's not good practice.

The Hall sensor strip connects the HALL sensor to the chip itself. The Hall sensor picks up the signal from the finish line or pit lane entry and exit points. The strip must be mounted so that the chip is facing downwards. To secure the strip to the car, use blu-tac or double sided tape. Do not use hot glue: the sensor's strip will break if you try to move it around after glueing it.

	oXigen system	Doc.
	"Type C" Universal (O2-SSD-D132) and "B" (O2) in-car chip manual	Pag. 9/ 25

The 'B2' type chip

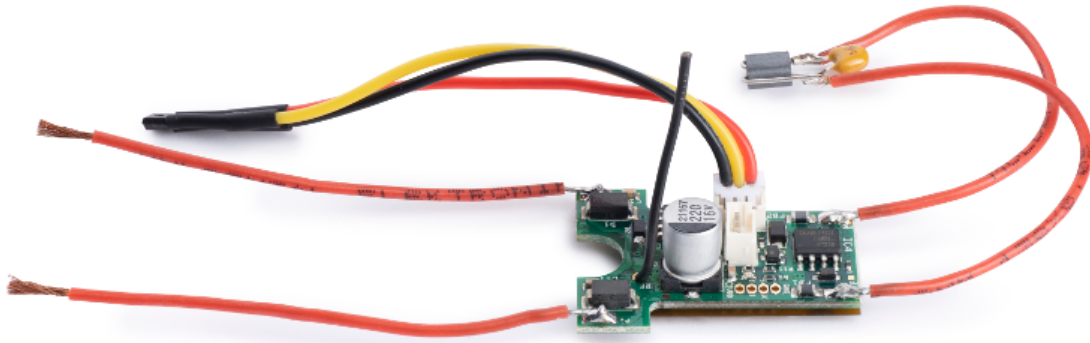

A "kapton" protective cover is glued to the bottom side of the chip to protect the electronic components. **Don't remove this protection to avoid damage to the chip AND loss of warranty.**

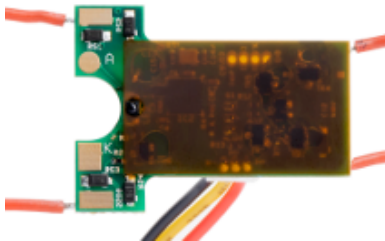

	<i>oXigen system</i>	Doc.
	"Type C" Universal (O2-SSD-D132) and "B" (O2) in-car chip manual	Pag. 10/ 25

Type B2 chip is sold with power wires connected to DC Pads. This is optimal for running on oXigen digital, and on analog tracks: the power is routed through one diode only, which keeps the voltage loss to a minimum. Such setup will work on Carrera D132 as well, but chipped car may only run in one direction.

To set the B2 'type chip in DC. or AC+DC mode, two separate sets of pads are provided, to connect the wires coming from the pickup: the soldering pads for the DC systems are on top of the chip, whereas the ones to be used for the AC systems are located on the bottom side.

This chip also provides extra pads to use an external lane changer LED on wires. There is no need to remove the standard LED, which is mounted directly on the board.

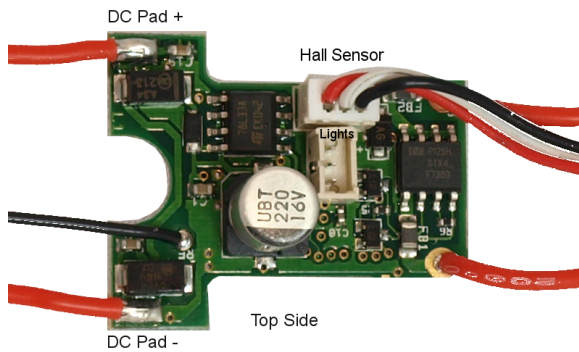

A.Box stock DC wired B2 IC, top side

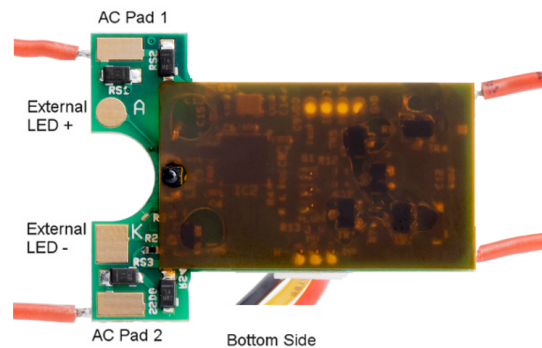

B.Box stock DC wired B2 IC, bottom side



A “kapton” protective cover is glued to the bottom side of the chip to protect the electronic components. **Don't remove this protection to avoid damage to the chip AND loss of warranty.**

	<i>oXigen system</i>	Doc.
	"Type C" Universal (O2-SSD-D132) and "B" (O2) in-car chip manual	Pag. 11/ 25

If you plan to race the car on a Scalextric SSD system as well, or if you want to make it run both ways (for example to match the running direction on a Carrera D132 system), then the power wires from the pickup must be soldered to the AC pads. See image "SSD circuit" (C.) below. If necessary, an external, wired LED can be connected to the board, soldering the LED wires to the provided LED pads as shown (D.).

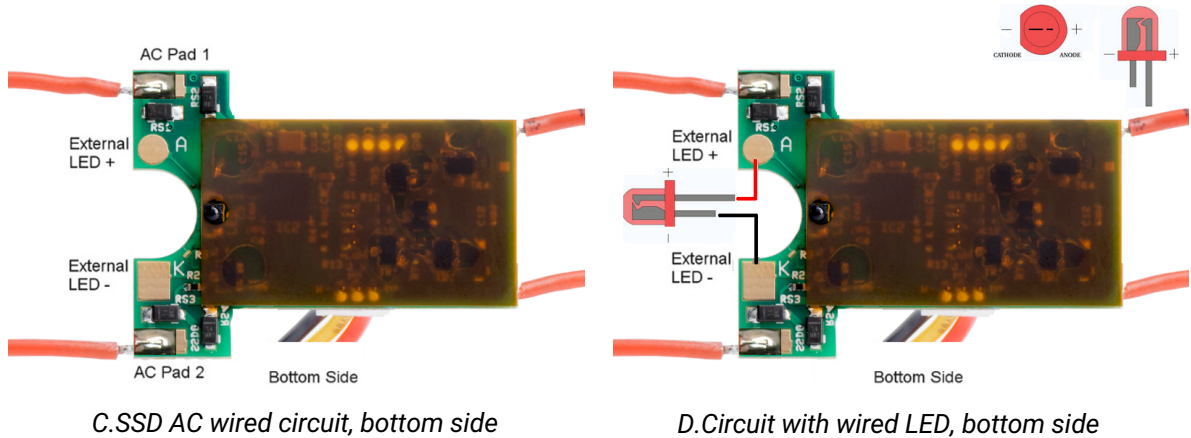

Once the chipped is properly placed inside the chassis, make sure the LED can be seen through the chassis hole:

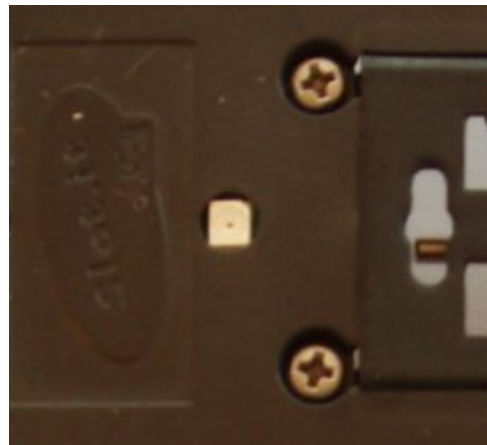

If you are running on Carrera D132 instead of oXigen or SSD, use the wired LED and place it so that it aligns with the Carrera receiver that can be found on the track, right before the lane changing mechanism.

	oXigen system	Doc.
	"Type C" Universal (O2-SSD-D132) and "B" (O2) in-car chip manual	Pag. 12/ 25

On the left side of the chip, attached to three wires colored in yellow, black and red, a unipolar Hall sensor

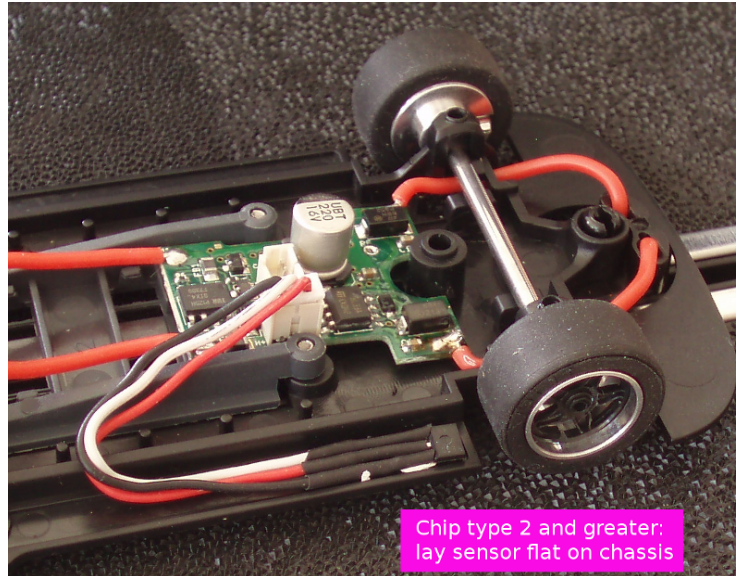

works as lap and finish line detector. This sensor is responsible of sensing the magnetic field created by magnets that, when placed under the track, delimitate the finish line and pit lane. Said Hall sensor must be fixed to the chassis of the car so that front face of the sensor, the bevelled one, is facing down. This is very important: laying the sensor with the bevelled side up won't work (unless the magnets are also wrongly placed!). The sensor must be laid flat on the chassis as described in the picture.

The antenna, which is the 2.5cm long piece of wire coming out from the top of the chip, should be kept vertical, within the realms of possible. It is not recommended to lay the antenna flat down on the chip or close to the motor. It will work, but it's not good practice.

Type 'B2' also comes with a red LED mounted on the top face. It blinks according to the following table:

Blinking type	Meaning
fixed	power is on, no link
fixed	power is on, UP arrow pressed
quick flashing	linked, no button pressed
off	no power
off	power is on, DOWN arrow pressed

	<i>oXigen system</i>	Doc.
	"Type C" Universal (O2-SSD-D132) and "B" (O2) in-car chip manual	Pag. 13/ 25

The FERRITE MAN

The name 'ferrite man' refers to the device made by one capacitor and one ferrite choke, which comes preassembled on the in-car chip wires, and that must be mounted on the motor terminals. Its purpose is to suppress electrical noise coming from the motor, that may interfere with the proper working of the in-car chip



The ferrite man is **REQUIRED**. It must be soldered on the motor copper tabs as described by these pictures. However... we have anecdotal evidence that if your motor is equipped with an electrical noise suppressor known as 'varistor ring' (a small ceramic ring located around the collector), the chip may work even without the ferrite man.

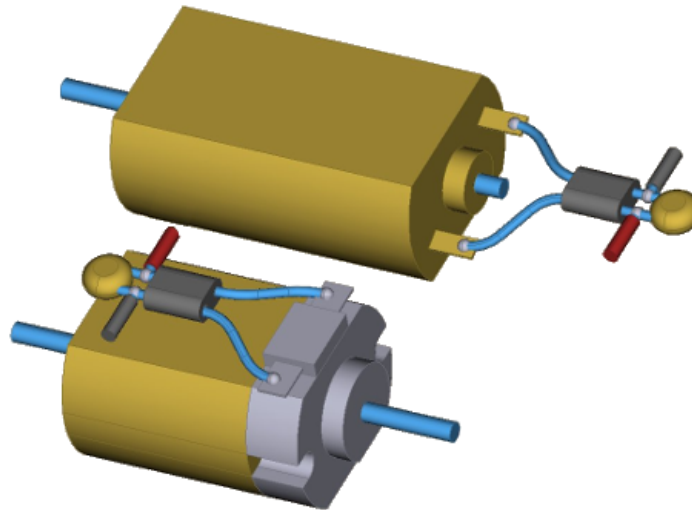

Short circuits of any of the 'ferrite man' limbs, either between themselves, or across any metallic parts (motor edges), will damage the in-car chip. Make sure the 'limbs' stay clear of each other and of any metallic parts

	<i>oXigen system</i>	Doc.
	"Type C" Universal (O2-SSD-D132) and "B" (O2) in-car chip manual	Pag. 14/ 25

oXigen in-car chip 'modes' vs. 'native' mode.

Up until type C chip, oXigen chips were only partially compatible with Scalextric SSD and Carrera D132 systems. This partial compatibility was called respectively 'SSD mode' and 'D132 mode'.

With the advent of type C we have full compatibility with the original systems, that is, type C can run on all three systems 'natively'. This means that the chip, once setup properly, will behave as a standard SSD or D132 chip: the commands are read from the rails rather than over the 2.4GHz link as in the oXigen system, and the chip responds to those commands like a Scalextric SSD or Carrera D132 chip.

In most cases, the communication between the car and the lane changers and/or lap counter is done through an infrared-emitting LED. Unfortunately, while oXigen and SSD share the basics of such infrared protocol, Carrera systems are completely different. For this reason, each car must be programmed so that its working 'mode' is appropriate for the intended use.

In other words: with oXigen firmware loaded (type C) and always with type B2, you must select the modes depending on what lane changers you are using.

If you use the oXigen chip with:

- an oXigen system, and the oXigen lane change electronics, modes 'y' or 'o' are both correct.
- an oXigen system, and the original unmodified Scalextric SSD lane changer, select the 'o' mode.
- an oXigen system with Carrera unmodified D132 lane changers, select 'd' mode and refer to "Running with Carrera Digital D132" paragraph as the D132 lane changers require the original Carrera Power Base to operate.
- a Scalextric SSD system:
 - type C chip is natively compatible once the correct firmware is loaded
 - type B2, select 'h' mode and refer to 'Running with Hornby SSD Digital' paragraph
- a Carrera D132 system:
 - type C chip is natively compatible once the correct firmware is loaded
 - type B2, select 'd' mode and refer to 'Running with Carrera D132 Digital' paragraph

Refer to the in-car chip for further understanding

	<i>oXigen system</i>	Doc.
	"Type C" Universal (O2-SSD-D132) and "B" (O2) in-car chip manual	Pag. 15/ 25

IR TX means 'InfraRed Transmission'

oXigen in-car chip working modes			
Mode name	System	Note	
'y'	oXigen	IR TX always on. oXigen default. SSD lane changer compatible	
'o'	oXigen+SSD	IR TX on only when lane change request is made. Works on any oXigen Lane Change electronic board.	
'h'	SSD	Hornby SSD system mode for type B chips. Refer to 'Running with Hornby SSD Digital' paragraph	
'd'	Carrera D132	Carrera Digital system mode for type B chips. Refer to "Running with Carrera Digital D132" paragraph.	

Modes can be selected only with the Bootloader software. We have removed the feature from the controller as it made matters too complex.

oXigen 'hybrid' mode is necessary when running oXigen chipped cars with SSD lane changers. It is anyway advisable to use it every time oXigen cars are used with lane changers based on Ninco track pieces. On Carrera based lane changers, it doesn't matter which oXigen mode is selected.

Please refer to the relevant sections to understand how to run oXigen chipped cars on SSD or Carrera systems.

	<i>oXigen system</i>	Doc.
	"Type C" Universal (O2-SSD-D132) and "B" (O2) in-car chip manual	Pag. 16/ 25

The Autonomous Car

With the proper firmware, the type C and B2 chips can drive around the track with reasonable performance, once its limits and caveats are understood. The firmware is available for download from the Slot.it web site.

The principle is very simple: load the firmware (whose name ends in -ATC, such as O201c-O2-0310-200508-ATC.zip for example), place the car on the track before the finish line, press the up and down buttons at the same time for two seconds to set the car in 'recording' mode, then start driving. As soon as the car crosses the finish line magnet, it starts recording controller input.

After one lap, stop the car and press the same two buttons for two seconds if you're happy with the outcome.

Now lift the car, and switch off the controller it is linked to. Put the car on the track and (if the controller is off), it will ramp up to speed for 0.5". If the finish line is reached (i.e. magnet is detected), the car will start playing back the speed values that were saved during the 'learning lap'. The car resyncs every lap.

This is a very simple system and can only do so much, but if the track provides a good, constant grip, and the learning lap is driven with margin, the results can be quite good.

The most difficult thing to master, apart from the indispensable 'drive smoothly and allow ample braking and acceleration areas' advice, is this: when the car starts its first autonomous lap, it accelerates from zero to target speed with a smooth ramp, then keeps the target speed for 0.3", then it stops if no finish line is crossed. This 0.3" time limit is necessary to avoid cars from running away for an indefinite period of time, eventually crashing badly. Thus, depending on the distance from the finish line and also depending on the target speed, it may not cross the finish line with the expected speed, hence the first lap may be the most difficult to finish properly. It may be necessary to adjust the starting position (closer to or farther away from the finish line) so that the first lap is successfully completed in the best possible way. Sometimes, the car needs to be pushed so that it reaches a higher initial speed.

A good advice is to try crossing the finish line, at the beginning and at the end of the recorded lap, with the same speed.

In general, avoid all sliding and any sort of wheelspin, as they cannot be exactly reproduced lap after lap.

If a proper magnet is placed under the track, you may make this work on an analog track as well.

As we develop it, some parameters of the autonomous car may one day be adjusted via the app, thus making it more robust. Future developments include versions for Scalextric SSD, Carrera Digital D132, and detection of magnets of different polarity to enhance it further.

This software is provided absolutely without any sort of warranty, as it may cause the car to crash badly.

	<i>oXigen system</i>	Doc.
	"Type C" Universal (O2-SSD-D132) and "B" (O2) in-car chip manual	Pag. 17/ 25

Activation (registration) of your in-car chips

Starting from versions 3.10 the type C and B2 chip must be 'activated' i.e. the chip must be connected to the Slot.it app so that a few parameters are recorded inside the chip's permanent memory and in our database.

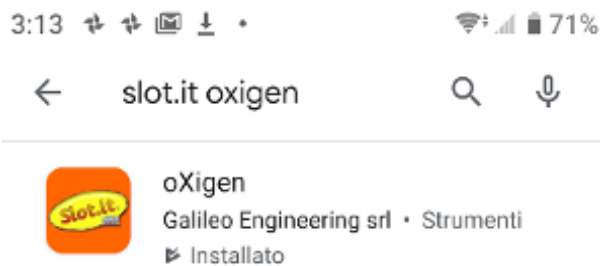

1. Search for oXigen in the APP store. Don't search for Slot.it unless you want get a darn slot machine game. Sownload and install the Slot.it APP on your Android (Android 7.0 or greater) or iOS device. Make sure the geographic location is turned on. This is need by Android Bluetooth function, we don't use such data.

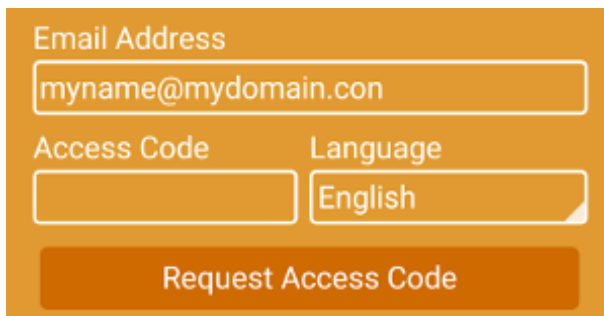

2. Register yourself (email necessary) to access the APP. Enter your email, and tap on the 'Request Access Code' field. The APP sends a confirmation email is sent to your address: copy the code from your inbox, and enter it into the app in the 'Access Code' field. Now press the 'User Login' button that has just appeared
3. Power on the chip. After about 10" the LED will flash and then turn off.

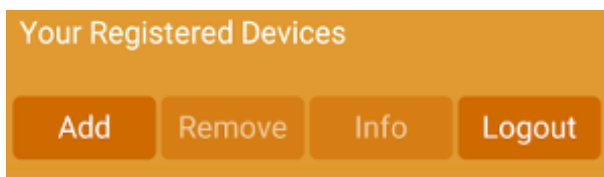

4. So launch the APP (you've done that already if you've followed steps 1. and 2.), login if necessary, then click 'Add'

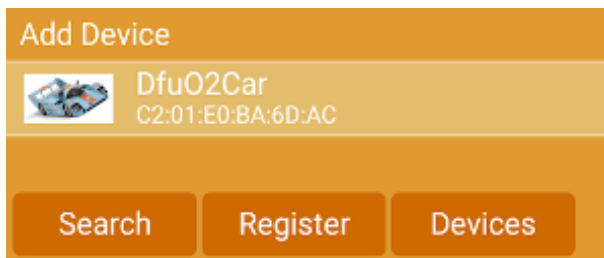

5. The APP searches for a while (you will see a spinning circle in the middle of the screen), then when the chip is detected, it appears on screen. At this points two things may happen: if your firmware is obsolete, the APP asks you to upgrade it, else it will prompt for a name that you should give your chip.

	<i>oXigen system</i>	Doc.
	"Type C" Universal (O2-SSD-D132) and "B" (O2) in-car chip manual	Pag. 18/ 25

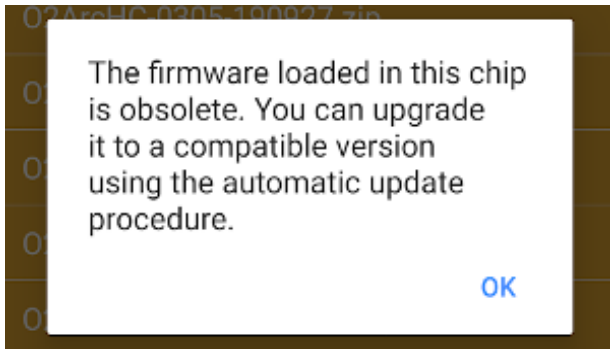

- If you see this message, select OK, then proceed further. Select the appropriate version (the name of the chip firmware begins with O201C...) for example O201C-310-200520, tap on 'Confirm upgrade' then on 'OK' once the upgrade is finished.
If this image doesn't appear, you don't need to upgrade the firmware, unless you are suggested otherwise.

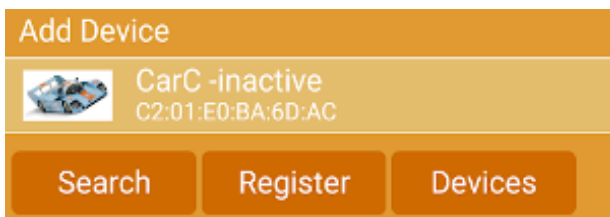

- Tap register, name your chip, and you're done. Tap on 'Devices' to see the list of your registered devices.



- You may now add more Slot.it devices or tap on 'Info' to know all about your device (this is the same data that we store in your database)

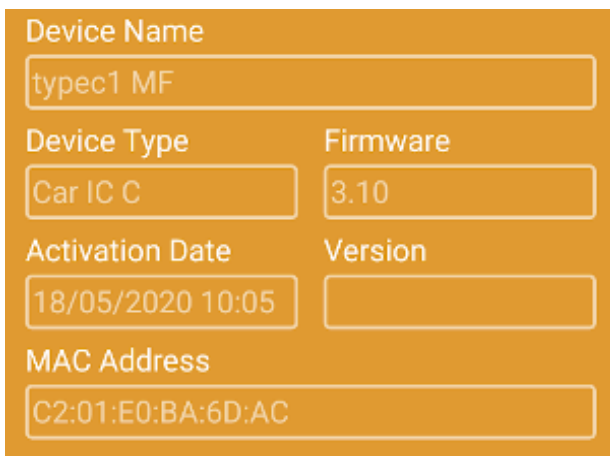

- The name can be changed at will. You can name the chip so that, for example, you give a meaningful name such as 'Porsche956 n.3'. Name length is limited to 14 characters.

	<i>oXigen system</i>	Doc.
	"Type C" Universal (O2-SSD-D132) and "B" (O2) in-car chip manual	Pag. 19/ 25

Updating Firmware – basics

To perform a firmware upgrade, chip must be in **DFU mode (Direct Firmware Update)**. We've tried to make it easy for customers, especially for those who only use type C chip as a SSD or D132 unit, to avoid the use of the oXigen dongle.

Starting from versions 3.10 (oXigen) - 1.10 (SSD and D132 native, type C only) or greater, the firmware of the in car chips must be upgraded using the Slot.it app.

If your firmware version is older than 3.10 (oXigen) - 1.10 (SSD and D132 native, type C only) the firmware of the in car chips can also be upgraded using the Nordic Semiconductors app. DFU can be invoked by the Bootloader (which hands control to the Nordic app) or at power on. Read below to understand why and how.

The Slot.it app establishes a Bluetooth Low Energy (BLE) communication link between the chip and the phone. When you ask the app to upgrade the firmware, the app informs the chip, and the chip goes into Direct Firmware Upgrade mode (DFU). The app then fetches the firmware from our web site and starts the DFU procedure. To make this all possible, the firmware inside the chip must be able to understand the app commands – and this is only possible with versions greater than 3.10 or 1.10 as said above.

However, the latest versions of the Slot.it app can detect early firmware, and bring it up to the latest version.

It is important to understand that firmware 3.10 and greater requires the activation with the APP, therefore, after you upgrade from 3.06 (say) to 3.10, you **must** register (Activate) the chip!

The new firmware versions remain compatible with the Bootloader.

How to start BLE so that it can be contacted with the Slot.it app: if your chip is:

- **New (factory fresh, firmware 3.10 and later):** BLE starts automatically. Contact the chip with the app, then register it and upgrade if so desired.
- **oXigen:** switch off the controller, if any are linked to the chip. Power on the chip (car) on DC power, wait 10 seconds. 5 flashes follow (only from version 3.05 onwards)
- **SSD and D132:** leave the chip on SSD track for 10" without pulling the controller's trigger, then press the lane change button for 2".

Once this is done, the chip can be contacted by the Slot.it app. Press 'Connect'.

Alternatively, there is also a backdoor to start DFU to contact the chip with the Nordic DFU app: this is true for all firmware versions

- **oXigen, SSD, D132:** power on the chip while the Hall sensor is placed on a magnet (South pole polarity – if it doesn't work, reverse the sensor or the magnet).

Alternatively, at power on the chip tries to detect whether it is on the right track for the firmware it is loaded with. If not, it will enter DFU mode. Therefore, this is an alternate way to activate DFU mode.

- **oXigen:** switch off the controller, if any are linked to the chip. Power on the chip (car) on SSD or D132 power.
- **SSD/D132:** Power on the chip (car) on a DC powered track. Chip enters DFU mode after 5"

Once this is done, the chip is in DFU mode and can be contacted with the Nordic app

	oXigen system	Doc.
	"Type C" Universal (O2-SSD-D132) and "B" (O2) in-car chip manual	Pag. 20/ 25

And finally the chips can be contacted via the Bootloader (BL) of course: this is true for all firmware versions released, new and old.. Follow BL instructions. Summary:

- **oXigen:** switch off the controller, if any are linked to the chip. Power on the chip (car) on a DC powered track (such as a standard oXigen one). Contact the chip with BL within 10". Once the BL is linked to the chip, click on 'UPDATE FIRMWARE'. This sets the chip in DFU mode and hands it over to the Nordic app.
- **SSD:** no bootloader available.
- **D132:** no bootloader available.

How to update firmware with the Slot.it APP

This section assumes that you are familiar with the Slot.it app and that your chips have been registered already.

Start BLE in your chip, according to the procedure above.

Contact your in-car chip, then select DFU. The app will take you to a list of firmware versions, Pick the one you want, then start DFU upgrade.

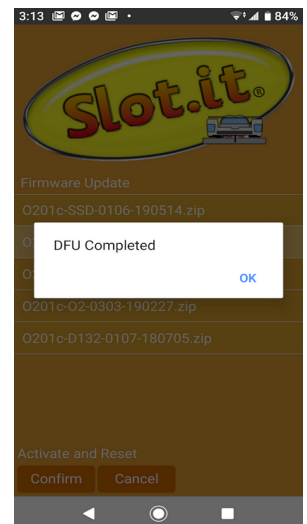
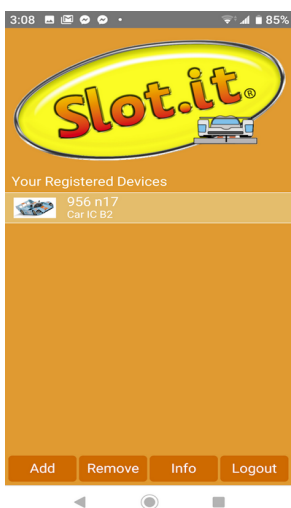

Any upgrades (or downgrades) starting from firmware versions 3.10 / 1.0 or greater should in principle be made with the app, unless you use the BL or the DFU backdoor (Nordic app).

Firmware earlier than 3.10 or 1.10 are not app compatible, therefore upgrades or downgrades must be made via the BL or the DFU backdoor (Nordic app).

	oXigen system	Doc.
	"Type C" Universal (O2-SSD-D132) and "B" (O2) in-car chip manual	Pag. 21/ 25

How to update firmware with the Slot.it Bootloader.

The Bootloader itself can only upgrade firmware for the legacy, discontinued chips type A and B.

For B2 and C types, the BL sets the chip in DFU mode, then hands it over to the Nordic DFU app.

To contact the chip with the oXigen bootloader, make sure that any oXigen or ARC PRO controllers paired to the car are switched off, then apply power to the car chip (for example, put it on the powered track rails) and click on the 'YES' button within ten (10) seconds. Note that as the car can enter the 'bootloading' mode only during the first ten seconds after it's been powered on, so, if the car was *already* powered, you must switch it off first, then on again. Also note that if the car receives a valid driving command from its own controller, it cannot enter bootloading mode either, so *make sure the controllers are switched off!*

	<i>oXigen system</i>	Doc.
	"Type C" Universal (O2-SSD-D132) and "B" (O2) in-car chip manual	Pag. 22/ 25

How to update firmware with the NORDIC APP

The upgrade can be initiated with the Bootloader or by putting the chip directly in DFU mode via the above mentioned backdoor (also known as the 'magnet trick').

1. Download the *nRF toolbox app* from the *Google Play store*.



2. Download the firmware version that you want to put on your chip from our website (<http://www.slot.it> – oXigen Download Firmware area) on the Android device. Note where it is being saved. Remember that Your firmware has a name and the name follows this convention: *O201c-sys-reldate.zip* file, where:

sys: system oXigen (O2), Scalextric SSD (SSD) or Carrera digital (D132)

rel: firmware release number

date: firmware release date

Example:

O201c-O2-170823.zip: oXigen firmware released on Aug 23, 2017

O201c-SSD-180423.zip: SSD firmware released on Apr 23, 2018

O201c-D132-180502.zip: D132 firmware released on May 2, 2018

3. Start the *nRF Toolbox app* on the device and select DFU button



	<h1>oXigen system</h1>	Doc.
	<p>"Type C" Universal (O2-SSD-D132) and "B" (O2) in-car chip manual</p>	<p>Pag. 23/ 25</p>

- Tap on *SELECT DEVICE* and choose *DfuO2Car* which should appear in the list of available devices, under your list of paired/bonded devices. If it is not present, repeat the steps above to set the chip to *DFU* mode.

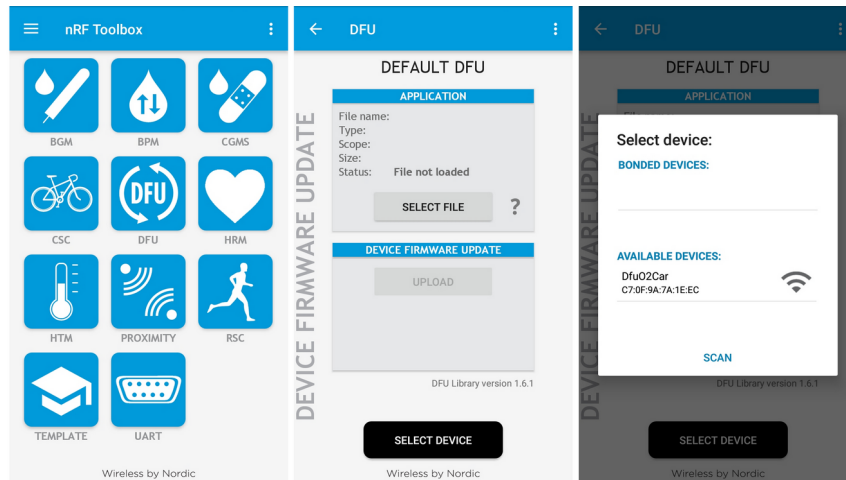

- Tap on *SELECT FILE*

- Choose *Distribution packet (ZIP)* and press *OK*.

Now locate the file you just downloaded at step 2, select it, then select *Scope: All*

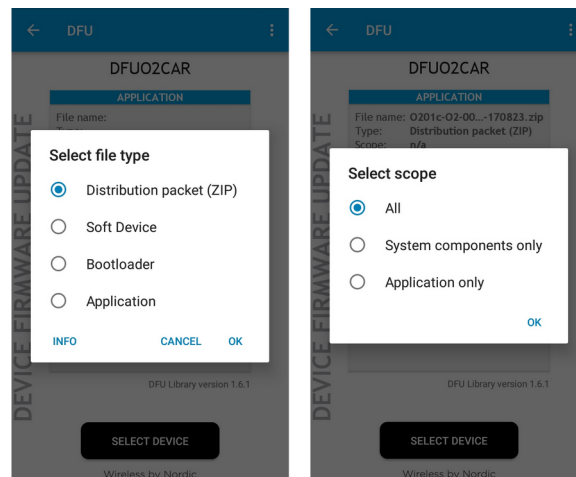

If given a choice, choose the whole file, not a part of it. Once the file has been selected, the app returns to the *DFU* screen.

	oXigen system	Doc.
	"Type C" Universal (O2-SSD-D132) and "B" (O2) in-car chip manual	Pag. 24/ 25

7. Tap on *UPLOAD*: Firmware upgrade should start and be finished in a few seconds.

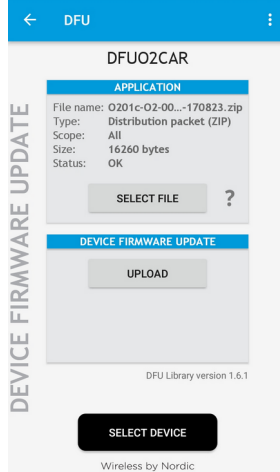

8. The chip resets automatically after being upgraded, but you may need to lift and put the car back on the track before using it.
9. The area of memory which is reserved to pairing info and other setup values is not overwritten during the update of the firmware, therefore your pairing will not be lost.

	<i>oXigen system</i>	Doc.
	"Type C" Universal (O2-SSD-D132) and "B" (O2) in-car chip manual	Pag. 25/ 25

Chip history and compatibility

Chip type	Year	Firmware	Status
A	2009	2.13	discontinued and unsupported
B	2011	2.13	discontinued and unsupported
B1	2014	3.01	partly supported
B2	2018	3.10	in production
C	2018	3.10	supported (O2 only)
C1	2019	3.10	in production