



Sicherheit beginnt mit einem guten Griff

Safety begins with a good handle

HF-Handgriffe

Ergonomisch - funktionell - langlebig

HF-Handgriffe aus dem Hause REGER sind durchdacht entwickelt, zeichnen sich durch eine anwendungsorientierte Außenkontur aus und bilden eine sichere Einheit mit den Generatoren. Für die individuellen Bedürfnisse bieten wir Ihnen unterschiedliche Modelle an. Der Premium-Handgriff ist griffig, breit und liegt gut in der Hand. Der Evoline-Handgriff hingegen ist schmal, sehr filigran und liegt wie ein Stift in der Hand.

Für beide gilt: Sie sind ergonomisch geformt und aus biokompatiblen Kunststoff gefertigt und für alle gängigen Generatorenanschlüsse erhältlich. Die Produkte können auch individuell produziert werden.

HF-Handles

Ergonomic - functional - long lasting

The design of the REGER HF-handles is sophisticated and applied ergonomic shape. Therefore the products build a safe unit in combination with the HF-generator. We offer different models according to your individual needs.

The Premium-Handle has a good grip, is wide and fits comfortably in your hand. The Evoline-Handle on the contrary is narrow, very filigree and like a pen in your hand.

For both handles applies: they are ergonomically shaped and made of biocompatible plastics. Furthermore, different plugs allow combination with all common HF-generators

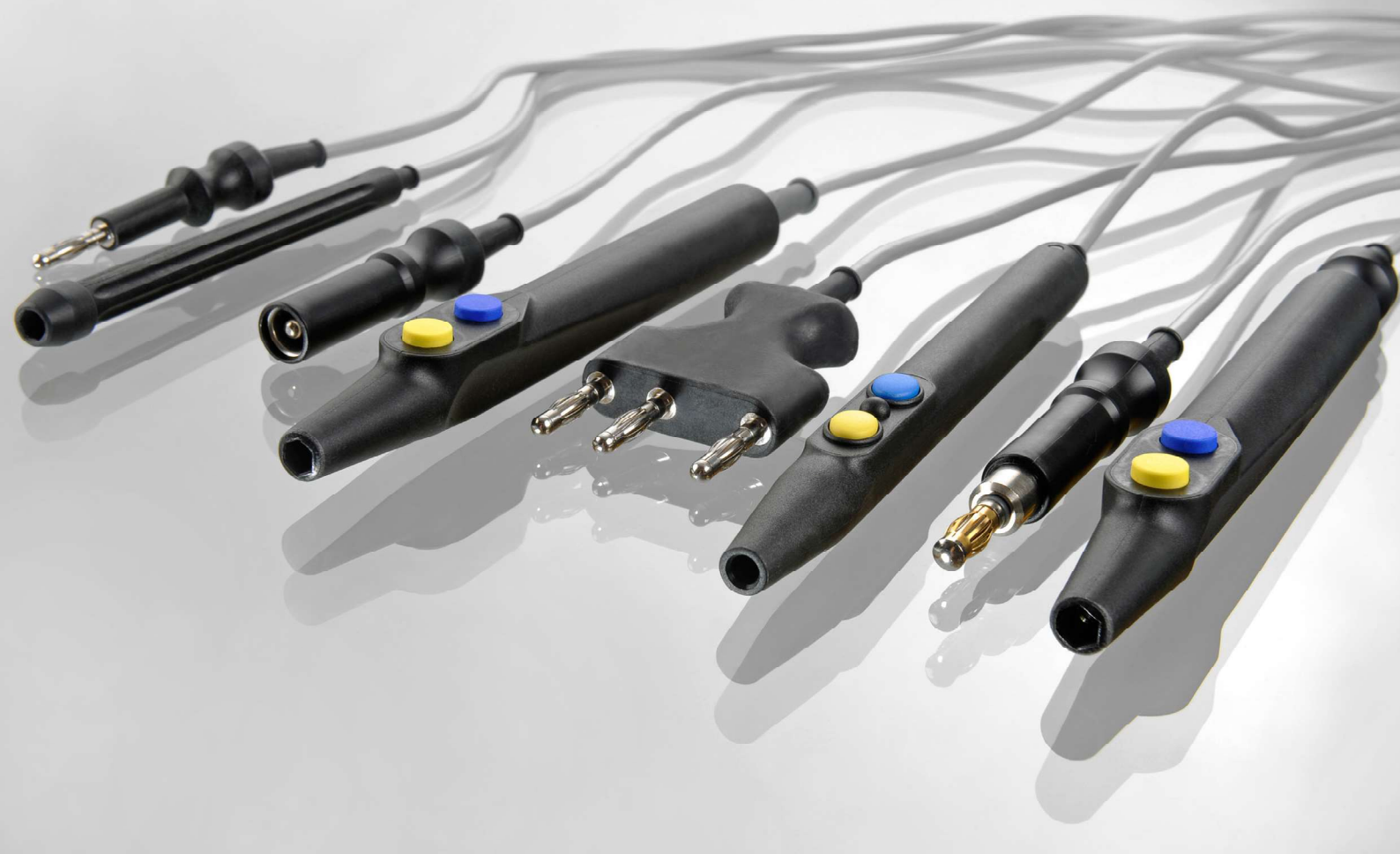

HF-Handgriffe

HF-Handles

Premium Handgriffe
Premium handles



87-91

evoline Handgriffe
evoline handles



92-93

Handgriffe ohne Tasten
Handles without buttons



94-95

Verbindungsadapter
Connection adapters



96

· Für Elektroden mit 4 & 2,4 mm Schaft
For electrodes with 4 & 2.4 mm shaft

· Mit Sechskant-Verdrehsicherung
With hexagon-anti-twist protection

· Bis zu 300-mal resterilisierbar
Up to 300 resterilization cycles

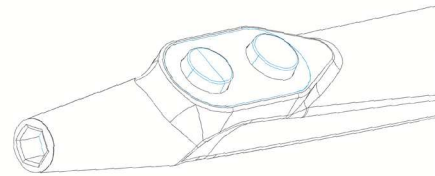

HF-Handgriff PREMIUM HF-pencil PREMIUM



PREMIUM

| | | | |
|-----------------------------------|--|-------------|---------|
| Artikel-Nr. item code | 92047 | | |
| Beschreibung description | HF-Handgriff Erbe für 4 mm -Schaft-Elektroden mit 2 Tasten HF-pencil Erbe for 4 mm -shaft-electrodes with 2 buttons | | |
| VPE unit | 1 | Umax | 4,3 kVp |

| | | | |
|-----------------------------------|--|-------------|---------|
| Artikel-Nr. item code | 92048 | | |
| Beschreibung description | HF-Handgriff Erbe für 2,4 mm -Schaft-Elektroden mit 2 Tasten HF-pencil Erbe for 2.4 mm -shaft-electrodes with 2 buttons | | |
| VPE unit | 1 | Umax | 4,3 kVp |

Anschluss | connection

| | | |
|-----------------------------------|---------------------------------|--------------|
| Artikel-Nr. item code | 92070 | 92071 |
| Länge length | 4 m | 5 m |
| Beschreibung description | Kabel/Cable Erbe ICC/ACC, Storz | |



· Für Elektroden mit 4 & 2,4 mm Schaft
For electrodes with 4 & 2.4 mm shaft

· Mit Sechskant-Verdrehsicherung
With hexagon-anti-twist protection

· Bis zu 300-mal resterilisierbar
Up to 300 resterilization cycles

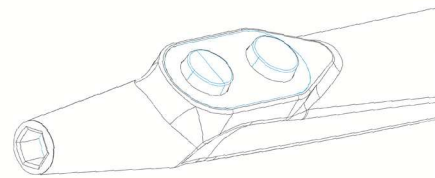

HF-Handgriff PREMIUM HF-pencil PREMIUM



PREMIUM

| | | | |
|-------------------------------------|--|-------------|---------|
| Artikel-Nr. item code | 92043 | | |
| Beschreibung description | HF-Handgriff Berchtold für 4 mm -Schaft-Elektroden mit 2 Tasten HF-pencil Berchtold for 4 mm -shaft-electrodes with 2 buttons | | |
| VPE unit | 1 | Umax | 4,3 kVp |

| | | | |
|-------------------------------------|--|-------------|---------|
| Artikel-Nr. item code | 92044 | | |
| Beschreibung description | HF-Handgriff für 2,4 mm -Schaft-Elektroden mit 2 Tasten HF-pencil Berchtold for 2.4 mm -shaft-electrodes with 2 buttons | | |
| VPE unit | 1 | Umax | 4,3 kVp |

Anschluss | connection

| | | |
|-----------------------------------|--|--------------|
| Artikel-Nr. item code | 92041 | 92040 |
| Länge length | 4 m | 5 m |
| Beschreibung description | Kabel/Cable Martin, Berchtold, Integra | |



· Für Elektroden mit 4 mm Schaft
For electrodes with 4 mm shaft



· Mit Sechskant-Verdrehsicherung
With hexagon-anti-twist protection

· Bis zu 300-mal resterilisierbar
Up to 300 resterilization cycles

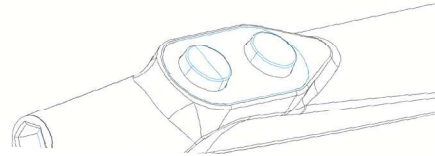

HF-Handgriff PREMIUM HF-pencil PREMIUM



PREMIUM

| | | | |
|----------------------------|---|------|---------|
| Artikel-Nr. item code | 92045 | | |
| Beschreibung description | HF-Handgriff ERBE T-Serien für 4 mm-Schaft-Elektroden mit 2 Tasten, blau HF-pencil ERBE T-Serie for 4 mm-shaft-electrodes with 2 buttons, blue | | |
| VPE unit | 1 | Umax | 4,3 kVp |

| | |
|----------------------------|--------------------------|
| Artikel-Nr. item code | 92072 |
| Länge length | 5 m |
| Beschreibung description | Kabel/Cable Erbe T-Serie |



HF-Handgriff PREMIUM HF-pencil PREMIUM



PREMIUM

| | | | |
|----------------------------|--|------|---------|
| Artikel-Nr. item code | 92049 | | |
| Beschreibung description | HF-Handgriff Berchtold für 4 mm-Schaft-Elektroden mit 1 Taste, grau für CUT HF-pencil Berchtold for 4 mm-shaft-electrodes with 1 button, grey for CUT | | |
| VPE unit | 1 | Umax | 4,3 kVp |

| | | | |
|----------------------------|--|-------|--|
| Anschluss connection | | | |
| Artikel-Nr. item code | 92041 | 92040 | |
| Länge length | 4 m | 5 m | |
| Beschreibung description | Kabel/Cable Martin, Berchtold, Integra | | |



· Für Elektroden mit 4 mm Schaft
For electrodes with 4 mm shaft

· Mit Sechskant-Verdrehsicherung
With hexagon-anti-twist protection

· Bis zu 300-mal resterilisierbar
Up to 300 resterilization cycles

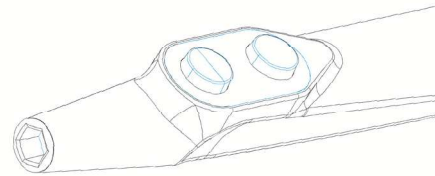

HF-Handgriff PREMIUM HF-pencil PREMIUM



PREMIUM

| | | | |
|---|--|-------------|---------|
| Beschreibung <i>description</i> | HF-Handgriff für 4 mm-Schaft-Elektroden mit integriertem Kabel, mit 2 Tasten <i>HF-pencil for 4 mm-shaft-electrodes, cable integrated, with 2 buttons</i> | | |
| VPE unit | 1 | Umax | 4,3 kVp |

Anschluss | connection

| | | |
|-----------------------------------|------------------------------------|--------------|
| Artikel-Nr. item code | 92247 | |
| Länge length | 5 m | |
| Beschreibung description | Erbe ICC/ACC, Storz | |
| Artikel-Nr. item code | 92240 | |
| Länge length | 5 m | |
| Beschreibung description | Erbe T-Serie | |
| Artikel-Nr. item code | 92241 | 92243 |
| Länge length | 3 m | 5 m |
| Beschreibung description | Martin, Berchtold, Integra | |
| Artikel-Nr. item code | 92246 | 92245 |
| Länge length | 3 m | 5 m |
| Beschreibung description | Valleylab, Internat. Modelle 3 Pin | |



- Für Elektroden mit 2,4 mm Schaft
For electrodes with 2.4 mm shaft
- Mit Sechskant-Verdrehsicherung
With hexagon-anti-twist protection
- Bis zu 300-mal resterilisierbar
Up to 300 resterilization cycles

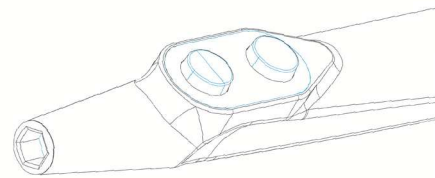

HF-Handgriff PREMIUM HF-pencil PREMIUM



PREMIUM

| | | | |
|---|--|-------------|---------|
| Beschreibung <i>description</i> | HF-Handgriff für 2,4 mm -Schaft-Elektroden mit integriertem Kabel, mit 2 Tasten <i>HF-pencil for 2.4 mm-shaft-electrodes, cable integrated, with 2 buttons</i> | | |
| VPE unit | 1 | Umax | 4,3 kVp |

Anschluss | connection

| | | |
|-----------------------------------|------------------------------------|--------------|
| Artikel-Nr. item code | 92251 | |
| Länge length | 5 m | |
| Beschreibung description | Erbe ICC/ACC, Storz | |
| Artikel-Nr. item code | 92248 | |
| Länge length | 5 m | |
| Beschreibung description | Martin, Berchtold, Integra | |
| Artikel-Nr. item code | 92242 | 92244 |
| Länge length | 3 m | 5 m |
| Beschreibung description | Valleylab, Internat. Modelle 3 Pin | |



- Für Elektroden mit 4 mm Schaft
For electrodes with 4 mm shaft
- Mit Sechskant-Verdrehsicherung
With hexagon-anti-twist protection
- Bis zu 300-mal resterilisierbar
Up to 300 resterilization cycles

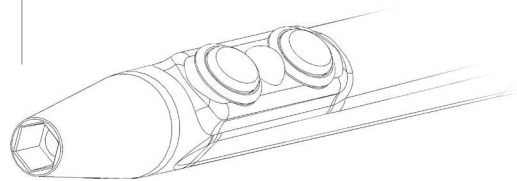

HF-Handgriff evoline HF-pencil evoline



evoline

| | | | |
|---|--|-------------|---------|
| Beschreibung <i>description</i> | HF-Handgriff für 4 mm-Schaft-Elektroden mit integriertem Kabel, mit 2 Tasten <i>HF-pencil for 4 mm-shaft-electrodes, cable integrated, with 2 buttons</i> | | |
| VPE unit | 1 | Umax | 4,3 kVp |

Anschluss | connection

| | | |
|-----------------------------------|------------------------------------|--------------|
| Artikel-Nr. item code | 92746 | 92747 |
| Länge length | 3 m | 5 m |
| Beschreibung description | Erbe ICC/ACC, Storz | |
| Artikel-Nr. item code | 92752 | |
| Länge length | 3 m | |
| Beschreibung description | Erbe T-Serie | |
| Artikel-Nr. item code | 92741 | 92743 |
| Länge length | 3 m | 5 m |
| Beschreibung description | Martin, Berchtold, Integra | |
| Artikel-Nr. item code | 92740 | 92745 |
| Länge length | 3 m | 5 m |
| Beschreibung description | Valleylab, Internat. Modelle 3 Pin | |

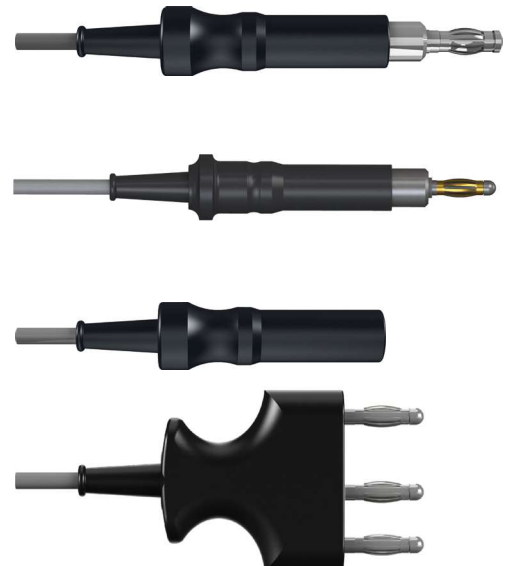

- Für Elektroden mit 2,4 mm Schaft
For electrodes with 2.4 mm shaft
- Mit Sechskant-Verdrehsicherung
With hexagon-anti-twist protection
- Bis zu 300-mal resterilisierbar
Up to 300 resterilization cycles

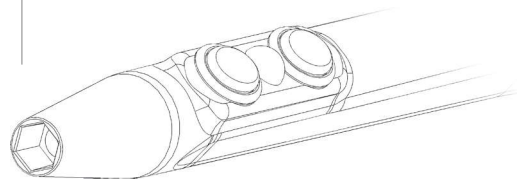

HF-Handgriff evoline HF-pencil evoline



evoline

| | | | |
|---|---|-------------|---------|
| Beschreibung <i>description</i> | HF-Handgriff für 2,4 mm -Schaft-Elektroden mit integriertem Kabel, mit 2 Tasten/ <i>HF-pencil for 2.4 mm-shaft-electrodes, cable integrated, with 2 buttons</i> | | |
| VPE unit | 1 | Umax | 4,3 kVp |

Anschluss | connection

| | | |
|-----------------------------------|------------------------------------|--------------|
| Artikel-Nr. item code | 92750 | 92751 |
| Länge length | 3 m | 5 m |
| Beschreibung description | Erbe ICC/ACC, Storz | |
| Artikel-Nr. item code | 92749 | 92748 |
| Länge length | 3 m | 5 m |
| Beschreibung description | Martin, Berchtold, Integra | |
| Artikel-Nr. item code | 92742 | 92744 |
| Länge length | 3 m | 5 m |
| Beschreibung description | Valleylab, Internat. Modelle 3 Pin | |



HF-Handgriffe ohne Tasten

HF-pencils without buttons

· Für Elektroden mit 4 & 2,4 mm Schaft
For electrodes with 4 & 2.4 mm shaft

· Mit Sechskant-Verdrehsicherung
With hexagon-anti-twist protection

· Bis zu 300-mal resterilisierbar
Up to 300 resterilization cycles

 4 mm & 2,4 mm

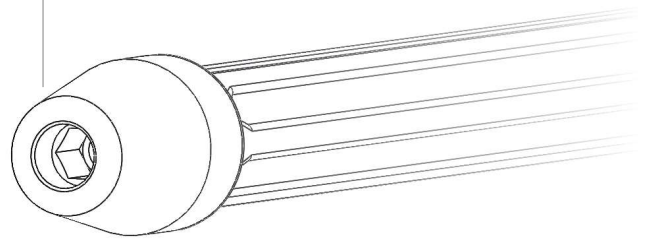

HF-Handgriff ohne Tasten HF-pencil without buttons



Beschreibung / description: HF-Handgriff für 4 mm-Schaft-Elektroden, mit integriertem Kabel, mit 2 Tasten, mit Federkorb zum Stecken
HF-Pencil for 4 mm-shaft-electrodes, cable integrated, without buttons, with spring cage for plugging

VPE | unit: 1 **Umax**: 4,3 kVp

Anschluss | connection

Artikel-Nr. | item code: 92645
Beschreibung | description: 4 mm Stecker / 4 mm plug
Länge | length: 5 m



HF-Handgriff ohne Tasten HF-pencil without buttons



Beschreibung / description: HF-Handgriff für 2,4 mm-Schaft-Elektroden, mit integriertem Kabel, mit 2 Tasten, mit Federkorb zum Stecken
HF-Pencil for 2,4 mm-shaft-electrodes, cable integrated, without buttons, with spring cage for plugging

VPE | unit: 1 **Umax**: 4,3 kVp

Anschluss | connection

Artikel-Nr. | item code: 92644
Beschreibung | description: 4 mm Stecker / 4 mm plug
Länge | length: 5 m



HF-Handgriffe ohne Tasten

HF-pencils without buttons

www.reger-med.de

- Für Elektroden mit 1,6 mm Schaft
For electrodes with 1.6 mm shaft
- Mit Sechskant-Verdrehsicherung
With hexagon-anti-twist protection
- Bis zu 300-mal resterilisierbar
Up to 300 resterilization cycles

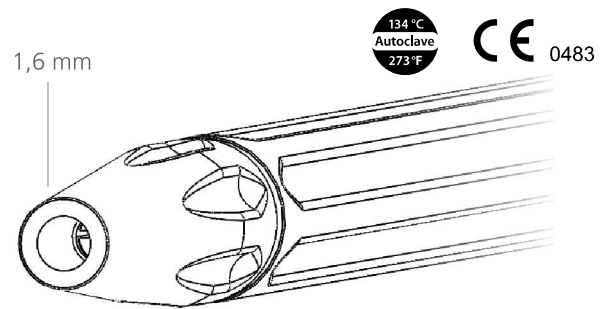

HF-Handgriff ohne Tasten HF-pencil without buttons



| | | | |
|------------------------------------|--|-------------|---------|
| Beschreibung description | HF-Handgriff für 1,6 mm -Schaft-Elektroden, ohne integrierten Tasten & Kabel, mit Spannkappe HF-Pencil for 1.6 mm -shaft-electrodes, without buttons cable integrated, with a chuck | | |
| VPE unit | 1 | Umax | 4,3 kVp |

Anschluss | connection

| | |
|-----------------------------------|----------------------------|
| Artikel-Nr. item code | 92098 |
| Beschreibung description | Erbe ICC/ACC, Storz |
| Länge length | 3 m |
| Artikel-Nr. item code | 92097 |
| Beschreibung description | Martin, Berchtold, Integra |
| Länge length | 3 m |
| Artikel-Nr. item code | 92096 |
| Beschreibung description | 4mm Stecker / 4 mm plug |
| Länge length | 3 m |
| Artikel-Nr. item code | 92300 |
| Beschreibung description | Ellman |
| Länge length | 3 m |

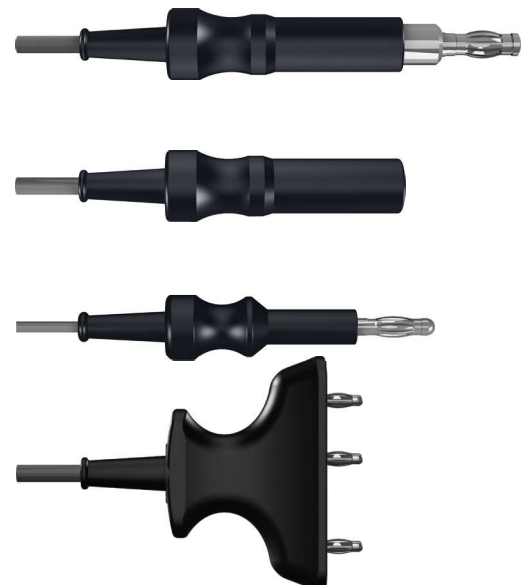

· Für HF- und RF-Generatoren geeignet
Applicable for HF- and RF-generators

· Wiederverwendbar
Reusable

· Autoklavierbar (134° C)
Autoclavable (134° C)

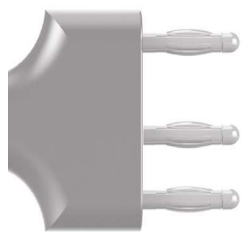
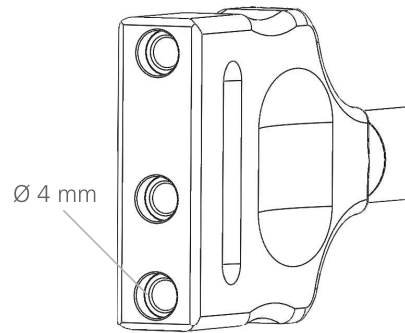

Artikel-Nr. | item code

92395

Beschreibung

description

Adapter von Valleylab, Int. auf Erbe, Storz
Adapter of Valleylab, Int. to Erbe, Storz

Maße | dimensions

4 mm

VPE | unit

1

U_{max}

4,3 kVp

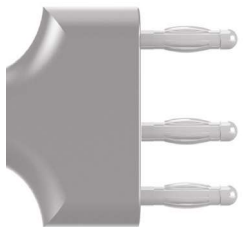

Artikel-Nr. | item code

92396

Beschreibung

description

Adapter von Valleylab, Int. auf Martin, Berchtold, Integra
Adapter of Valleylab, Int. to Martin, Berchtold,

Maße | dimensions

4 mm

VPE | unit

1

U_{max}

4,3 kVp



HF-Kabel

Hoch flexibel - korrosionsbeständig - belastbar

HF-Cables

Highly flexible - corrosion resistant - resilient

Die REGER HF-Kabel aus biokompatiblen Kunststoffen stellen eine zuverlässige und sichere Verbindung zu allen gängigen Generatoren her. Das umfangreiche Sortiment umfasst sowohl genormte Standardanschlüsse als auch zahlreiche Steckervarianten für Sonderinstrumente. Die Litzen unserer hoch flexiblen Leitungen sind versilbert. Dies reduziert die Korrosionsanfälligkeit und verlängert die Lebensdauer.

Die hier aufgeführten Kabel stellen nur einen Teilbereich des kompletten Portfolios dar. Gerne bieten wir Ihnen weitere Varianten auf Anfrage an.

REGER HF-cables are made from biocompatible plastics and allow for a reliable and safe connection to all common generators. The extensive range includes both: standardized plugs as well as many connector types for special instruments. The strands of our highly flexible cables are silver coated. This reduces the susceptibility to corrosion and prolongs the lifetime.

The following overview only represents a small part of our entire product portfolio. Please contact us for your needed configurations. We will be happy to serve you.



HF-Kabel

HF-Cables

Monopolare HF-Kabel
Monopolar HF-cables

Bipolare HF-Kabel
Bipolar HF-cables

Neutralelektroden Zubehör
Neutral electrodes accessories



99

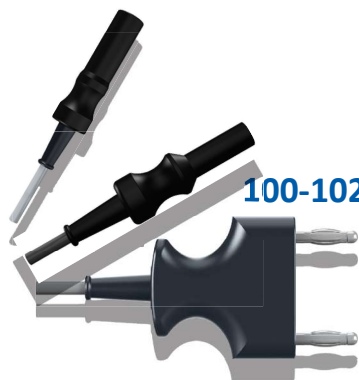

100-102

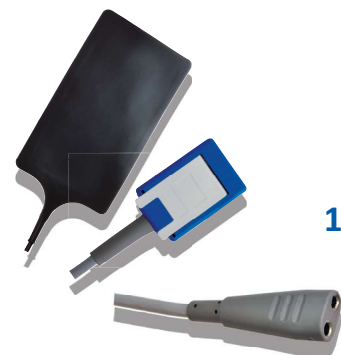

103

Langlebig, hoch flexibel und hochwertig
Durable, highly flexible and high quality

· Verbesserter Korrosionsschutz
durch versilberte Litzen unserer monopolaren
Anschlüsse

Improved corrosion protection through
silver-plated strands of our monopolar pins

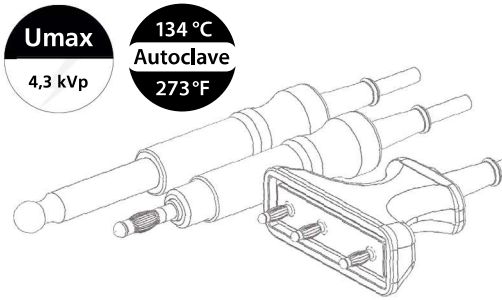





Umax
4,3 kVp

134 °C
Autoclave
273 °F



Monopolar

Geräteseite / Unit connecting

| | | Buchse socket 4mm | Resektoskop resectoscope 2mm | Olympus Resektoskop Olympus resectoscope 3mm | Storz Resektoskop, gewinkelt Storz resectoscope, angled | Storz Resektoskop, gerade Storz resectoscope, straight | Arthroskopie, 6-Kant arthroscopie hexagon |
|--|-----|-------------------------|------------------------------------|--|--|---|--|
| Erbe VIO/ICC/ACC  | 3 m | 92002 | 92011 | - | - | - | 92081 |
| | 5 m | 92003 | 92012 | - | 92061 | 92063 | - |
| Martin; Berchtold; Integra  | 3 m | - | - | - | - | - | - |
| | 5 m | 92175 | 92184 | - | - | - | - |
| Erbe T-Serie / International 4mm  | 3 m | 92004 | 92009 | 92089 | 92042 | 92062 | - |
| | 5 m | 92005 | 92010 | 92090 | 92050 | - | - |
| Valleylab  | 3 m | 92051 | 92013 | - | - | - | - |
| | 5 m | 92105 | 92014 | - | - | - | - |
| Ellman  | 3 m | 92203 | - | - | - | - | - |
| | 5 m | - | - | - | - | - | - |

HF-Kabel bipolar

HF-cables bipolar

Langlebig, hoch flexibel und hochwertig
Durable, highly flexible and high quality

Verbesserter Korrosionsschutz
durch versilberte Litzen, auch bei unseren
bipolaren Modellen
Improved corrosion protection through
silver-plated strands, also with our bipolar
models

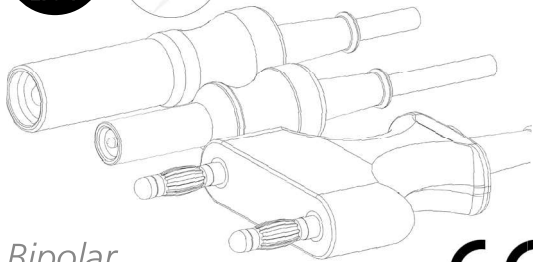
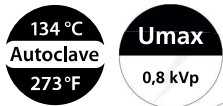

Bipolar

Geräteseite / Unit connecting



| | | | | | |
|----------------------------|-----|-------|-------|-------|-------|
| Valleylab | 3 m | 92029 | - | 92019 | 92115 |
| | 5 m | 92030 | 92196 | 92020 | 92094 |
| Erbe VIO/ICC/ACC; Storz | 3 m | 92023 | - | 92015 | 92110 |
| | 5 m | 92024 | 92190 | 92016 | 92111 |
| Martin; Berchtold; Integra | 3 m | 92025 | - | 92017 | 92113 |
| | 5 m | 92026 | 92192 | 92018 | 92092 |
| Ellman | 3 m | 92204 | - | - | 92138 |
| | 5 m | - | - | - | - |
| Uniflex | 3 m | 92127 | - | - | - |
| | 5 m | 92128 | - | - | - |
| ⚠ US-Modelle 2 Pol | 3 m | 92027 | - | 92021 | 92114 |
| | 5 m | 92028 | 92194 | 92022 | 92093 |



Nicht konform mit der internationalen Norm IEC 60601-2-2:2010-01.
Nur an bipolaren Ausgang von Hochfrequenzgeneratoren anschließen.
Not conform with the international standard IEC 60601-2-2:2010-01.
Connect to bipolar output for high-frequency generators only.

Zuverlässig und belastbar
Reliable and resilient

Hochwertiger, biokompatibler Kunststoff ermöglicht langlebige und belastbare Verbindungen
High-Quality and biocompatible synthetic material allows durable and resilient connections

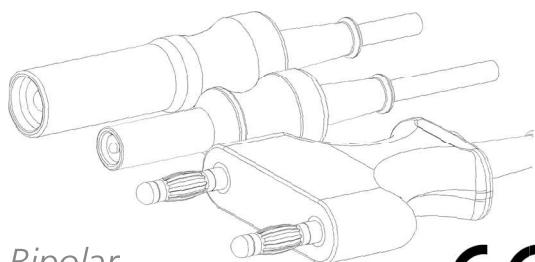
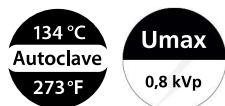

Bipolar

Geräteseite / Unit connecting



Stecker WOLF,
bipolare Zange
Plug WOLF
bipolar forceps



Stecker Aesculap,
Bipolarscheren
Plug Aesculap,
bipolar scissors
1,6mm

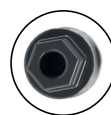



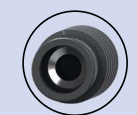

Stecker Ethicon
Powerstar-Schere
Plug Ethicon
Powerstar scissors
2,4mm



Flachstecker
Aesculap Pinzetten
Flat plug for
Aesculap forceps



| | | | | | |
|---|-----|--------------|--------------|--------------|--------------|
| Valleylab  | 3 m | 92116 | - | 92065 | - |
| | 5 m | - | 92141 | 92067 | 92075 |
| Erbe VIO/ICC/ACC; Storz  | 3 m | 92086 | - | - | - |
| | 5 m | 92087 | 92140 | 92066 | 92074 |
| Martin; Berchtold; Integra  | 3 m | - | - | - | - |
| | 5 m | 92088 | 92142 | 92068 | 92073 |
| Ellman  | 3 m | - | - | - | - |
| | 5 m | - | - | - | - |
| Uniflex  | 3 m | - | - | - | - |
| | 5 m | - | - | - | - |
| ⚠ US-Modelle 2 Pol  | 3 m | 92118 | - | - | - |
| | 5 m | - | - | 92069 | 92095 |



Nicht konform mit der internationalen Norm IEC 60601-2-2:2010-01.
Nur an bipolaren Ausgang von Hochfrequenzgeneratoren anschließen.
Not conform with the international standard IEC 60601-2-2:2010-01.
Connect to bipolar output for high-frequency generators only.

Verschiedenste Variationen für jeden Bedarf
Various variations for every requirement

Umfangreiches Sortiment mit zahlreichen
Kombinationen
Extensive assortment with many
combinations

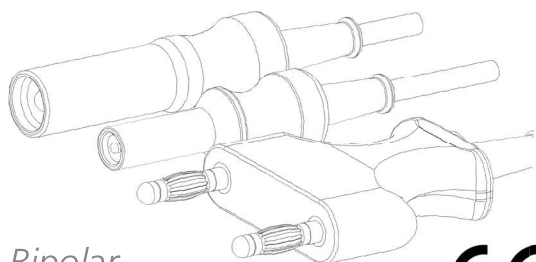
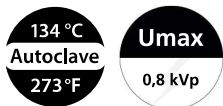

Bipolar

Geräteseite / Unit connecting

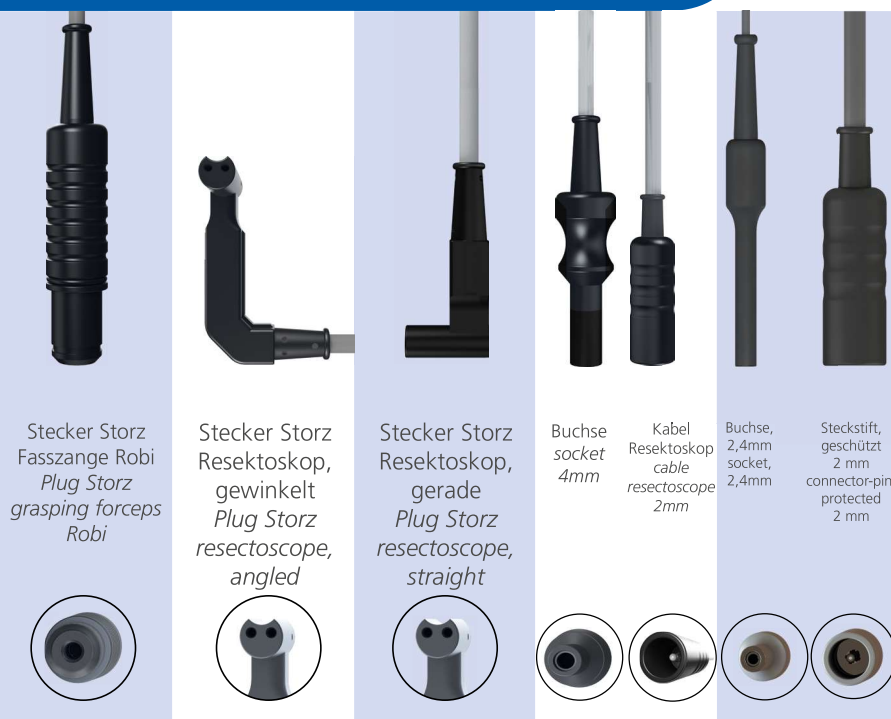

Stecker Storz
Fasszange Robi
Plug Storz
grasping forceps
Robi

Stecker Storz
Resektoskop,
gewinkelt
Plug Storz
resectoscope,
angled

Stecker Storz
Resektoskop,
gerade
Plug Storz
resectoscope,
straight

Buchse
socket
4mm

Kabel
Resektoskop
cable
resectoscope
2mm

Buchse,
2,4mm
socket,
2,4mm

Steckstift,
geschützt
2 mm
connector-pin,
protected
2 mm

| | | | | | | |
|-----------------------------------|-----|--------------|--------------|--------------|--------------|--------------|
| <p>Valleylab</p> | 3 m | 92037 | 92209 | 92197 | 92451 | 92230 |
| | 5 m | 92038 | 92210 | 92198 | 92504 | - |
| <p>Erbe VIO/ICC/ACC; Storz</p> | 3 m | 92031 | 92205 | - | 92452 | 92231 |
| | 5 m | 92032 | 92206 | - | - | - |
| <p>Martin; Berchtold; Integra</p> | 3 m | 92033 | 92207 | 92211 | 92453 | - |
| | 5 m | 92034 | 92208 | 92212 | - | - |
| <p>Ellman</p> | 3 m | - | - | - | - | - |
| | 5 m | - | - | - | - | - |
| <p>Uniflex</p> | 3 m | - | - | - | - | - |
| | 5 m | - | - | - | - | - |
| <p>US-Modelle 2 Pol</p> | 3 m | 92035 | - | - | - | - |
| | 5 m | 92036 | - | - | - | - |

Nicht konform mit der internationalen Norm IEC 60601-2-2:2010-01.
Nur an bipolaren Ausgang von Hochfrequenzgeneratoren anschließen.
Not conform with the international standard IEC 60601-2-2:2010-01.
Connect to bipolar output for high-frequency generators only.

Neutralelektrodenstecker

Neutral electrodes plugs

www.reger-med.de

Langlebig, hoch flexibel und hochwertig
Durable, highly flexible and high quality

· Verbesserter Korrosionsschutz durch versilberte Litzen
Improved corrosion protection through silver-plated strands

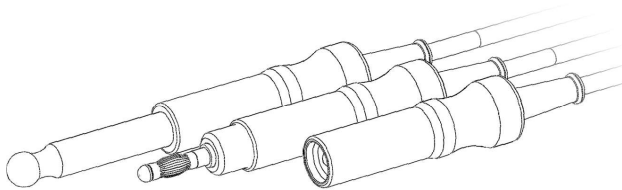
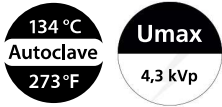

Geräteseite / Unit connecting

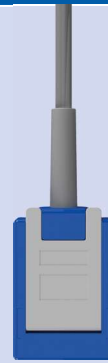

Flachstecker Einmal-Neutralelektroden
Flat plug single use neutral electrodes



Neutralelektrodenstecker
Neutral electrode plug



Neutralelektrodenstecker
Neutral electrode plug



Berchtold, Martin



3 m

-

-

-

5 m

-

-

92176

Erbe/Martin



3 m

92078

-

92077

5 m

92039

-

92076

Erbe ACC/ICC; Martin



3 m

-

92344

-

5 m

-

92345

-

Valleylab mit Pin



3 m

-

-

-

5 m

92139

-

-

Valleylab



3 m

-

-

92108

5 m

92145

-

92109

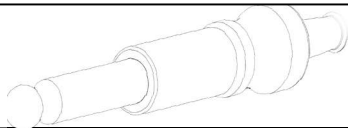

50 cm

260x150mm

-

92308

92342



50 cm

160x80 mm

-

92316

92343

1) Gummi-Neutralelektroden.
Anschluss erfolgt an Martin, Berchtold Neutralelektrodenstecker (siehe blauer Pfeil)
1) Rubber neutral electrodes.
Connect to Martin, Berchtold neutral electrode plug (mind the blue arrow)

2) Gummi-Neutralelektroden.
Anschluss erfolgt an Neutralelektrodenstecker (siehe blauer Pfeil)
2) Rubber neutral electrodes.
Connect to neutral electrode plug (mind the blue arrow)