

Extraoral 3D Imaging  
eco-x AI Series

[www.hdxwill.de](http://www.hdxwill.de)



# The companion for your digital practice

Artificial intelligence combined with sophisticated reconstruction algorithms



## The most important facts at a glance:

- o Freely scalable 3D volume for any jaw shape
- o Standard model 120 x 90 mm | Large model 160 x 90 mm FOV
- o Ø 50 x 50 mm volume in 100 µm for endodontics
- o Excellent image quality with the brilliant VIVIX-D sensor
- o Intelligent radiation dose reduction through anatomically adapted volume
- o Modern and intuitive 3D Image Viewer Will3D or OnDemand3D
- o Automatic AI Ceph analysis with WillCeph Pro

# eco-x CBCT with Artificial Intelligence

The eco-x AI CBCT covers the most important indications in 3D diagnostics with a volume of Ø120 x 90 mm (alternatively Ø160 x 90 mm). As a leading South Korean manufacturer, we are familiar with the problems that can occur with panoramic and CBCT images and have the appropriate solutions for them.

Using Auto Focus and Multi Layer functions, we enable excellent sharpness in panoramic images. With the eco-x AI, an accurate and precise 3D image of the tooth is reconstructed by taking 3D images in a 360-degree circle. Artificial shading caused by metals is recognized by our algorithms and effectively removed while preserving the tooth structure.

*"The 3D capture area can be individually adjusted with the eco-x AI, allowing for minimal radiation exposure, especially in children.*

*The Pano Scout function allows for precise determination of the 3D capture area, allowing for targeted diagnostic imaging.*

*The price-performance ratio is excellent, and the 2D and 3D image quality is truly remarkable. I can wholeheartedly recommend the eco-x AI system."*



**DR. DR. KRESHNIK GRAJCEVCI**  
Clinic Dental Pro Munich  
Dr. Dr. Kreshnik Grajcevcic

## Application of 3D Diagnostics

With eco-x AI DVT, you can have more confidence and security in treatment planning. Depending on the volume, subsequent treatments can be based on the 3D images captured by eco-x AI.

| Field of View (FOV) | Application   |
|---------------------|---|
| 50 x 50 mm          | Implant planning and evaluation, impacted tooth extraction, root canal treatment, single tooth and periodontal analysis   |
| < 80 x 80 mm        | Implant planning and evaluation, impacted tooth extraction, root canal treatment, single tooth and periodontal analysis, Unilateral TMD analysis, unilateral tooth and periodontal analysis.  |
| < 100 x 80 mm       | Implant planning and evaluation, impacted tooth extraction, root canal treatment, single tooth and periodontal analysis, Unilateral TMD analysis, full-jaw and periodontal analysis   |
| < 120 x 90 mm       | Implant planning and evaluation, impacted tooth extraction, root canal treatment, single tooth and periodontal analysis, Unilateral TMD analysis, full-jaw and periodontal analysis. surgical guide planning, sinus analysis, upper airway analysis                         |
| < 160 x 90 mm       | Implant planning and evaluation, impacted tooth extraction, root canal treatment, single tooth and periodontal analysis. Unilateral TMD analysis, full-jaw and periodontal analysis, Bilateral TMD analysis, surgical guide planning, sinus analysis, upper airway analysis |

# Less is more

## Partial 3D Scan via Pano Scout

Every clinical case comes with its unique requirements when it comes to volume size, dose, and image quality. The eco-x AI series addresses these needs by combining unparalleled image quality and flexibility, while adhering to the ALARA principle (As Low As Reasonably Achievable).

With the eco-x AI, you can adjust the volume size to fit the precise needs of each patient by selecting the 3D capture area in the existing panoramic X-ray image. From a focused  $\varnothing$  50 x 50 mm volume to a  $\varnothing$  120 x 90 mm volume that can depict wisdom teeth and upper airways, the possibilities are endless. And with the volume upgrade to  $\varnothing$ 160 x 90 mm, you can even capture both temporomandibular joints in one image.

Flexibly adjust the FOV from  $\varnothing$  50 x 50 mm to  $\varnothing$  120 x 90 mm using Pano Scout:

$\varnothing$  50 mm x 50 mm



$\varnothing$  50 mm x 50 mm volume is ideal for localized diagnosis, such as endodontic evaluations or individual implants

$\varnothing$  120 mm x 90 mm



$\varnothing$  120 mm x 90 mm volume is ideal for diagnosing the entire upper and lower jaw dentition, including wisdom teeth

$\varnothing$  160 mm x 90 mm



$\varnothing$  160 mm x 90 mm volume captures the complete dentition, parts of the maxillary sinus, and wisdom teeth. By replacing the chin rest, both temporomandibular joints can also be imaged.

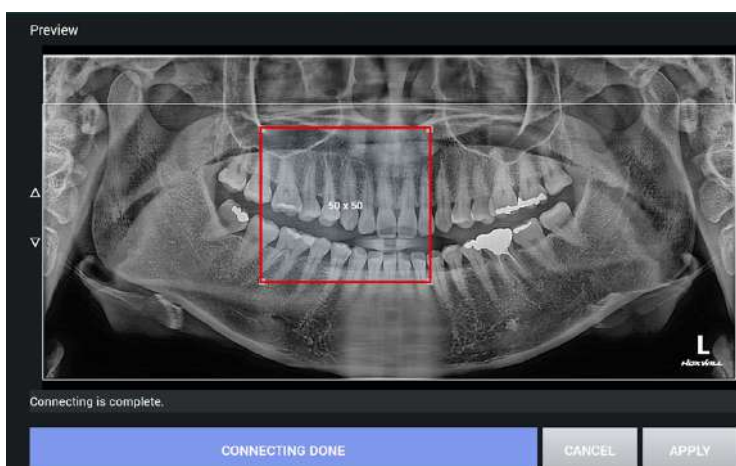

The 3D capture field can be determined precisely and accurately via the Panoramic Scout. The 3D capture field is drawn in the panoramic image using drag and drop.

The measuring field can be flexibly scaled from 50 x 50 mm so that only areas that are relevant for the diagnosis are scanned.

# AI MAR

## Metal Artifact Reduction with AI

Metal Artifacts can limit the diagnosis. We developed an AI Metal Artifact Reduction solution that can drastically reduce the Metal Artifacts with just one click.

AI MAR can greatly improve the accuracy and reliability of dental diagnoses and treatment planning, as it allows for clearer visualization of teeth and surrounding tissues.

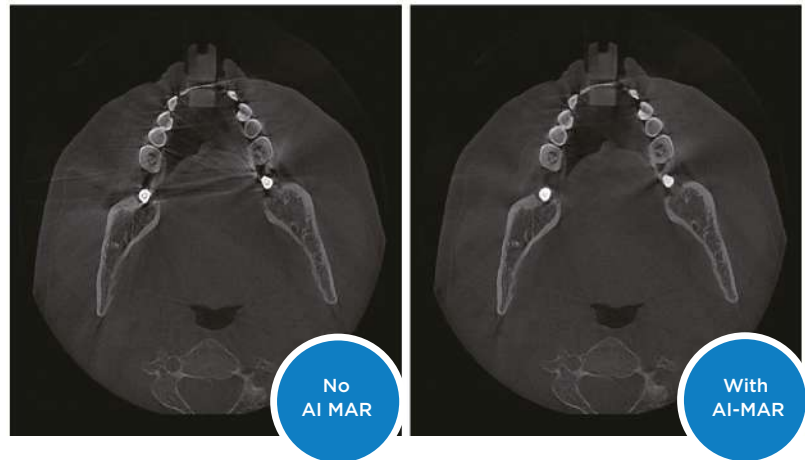

*AI MAR minimizes artifacts so that anatomically relevant structures are preserved.*

## Smart Low Dose CBCT

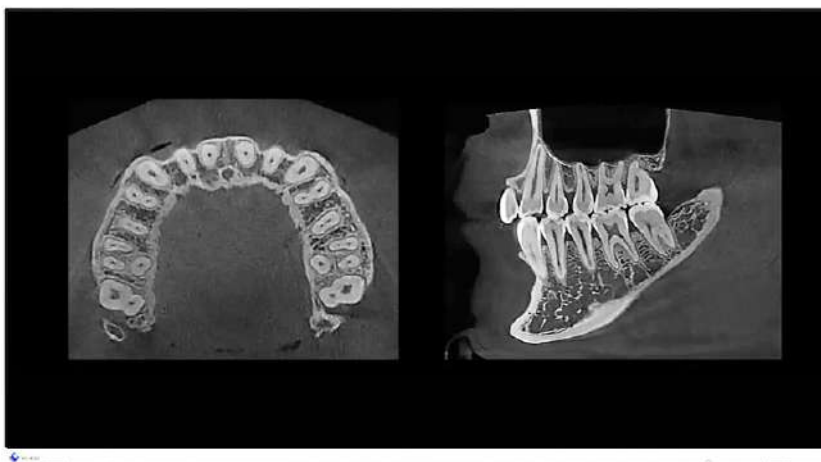

With eco-x AI, precise 3D images of the teeth can be generated through CBCT scans taken in a 360-degree orbit. Countless calculations are performed in the background to ensure that the images look great even at low doses.

The AEC function adjusts the radiation dose based on the size and thickness of the skull, allowing only the necessary amount of radiation exposure.

This means that patients can receive the care they need with minimal radiation exposure.

# Successful CBCT on the first try

Experience the perfect system for accurate diagnoses and optimal patient comfort with the eco-x AI series. Our state-of-the-art technology and intuitive software simplify the transition to digital dentistry, ensuring easy operation and precise positioning.

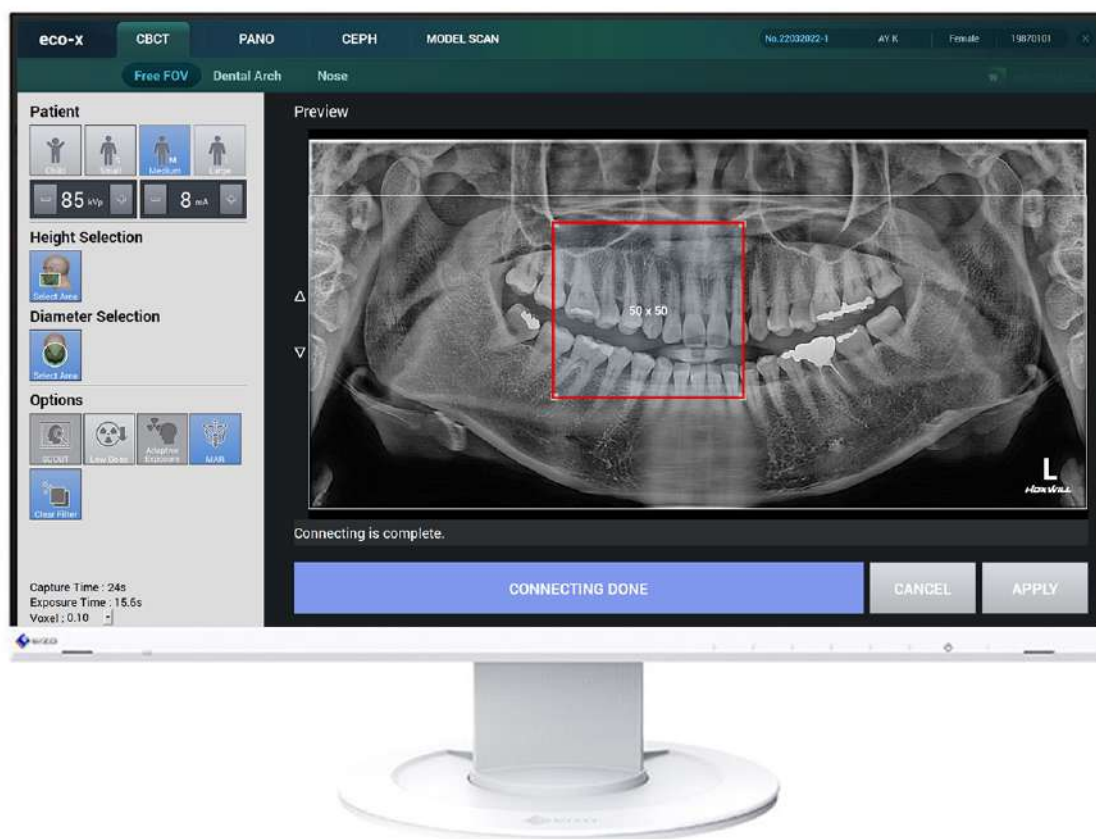

Before taking partial 3D images, the panoramic image can be used to precisely identify 3D examination areas.

## Pano Scout

With the eco-x AI system, placing the 3D measurement field within the panoramic scan has never been easier. The flexibility to adjust the measurement field to specific sizes provides a seamless, precise experience in selecting the 3D examination area. By simply dragging and dropping directly within the panoramic image, you can define the examination area with unparalleled precision, ranging from 50 x 50 mm to 120 x 90 mm.

## 2D Scout

The eco-x AI system offers a second option for determining the measuring field in partial DVT scans through the use of the 2D Scout function.

By capturing a lateral scout image, the 3D measuring field can be accurately set based on the scout image, allowing for precise and exact determination of the examination area.

# Low Dose CBCT

## Less Radiation Dose than Panorama

The optimized Low Dose mode reduces radiation exposure while maintaining image quality, making it an efficient option for many clinical tasks, particularly in orthodontics and implantology, where dense structures like bones need to be imaged.

With the two models of the eco-x AI series, you can choose to use high-resolution volumes for fine structures or low-dose imaging for minimal radiation exposure, depending on your individual needs.

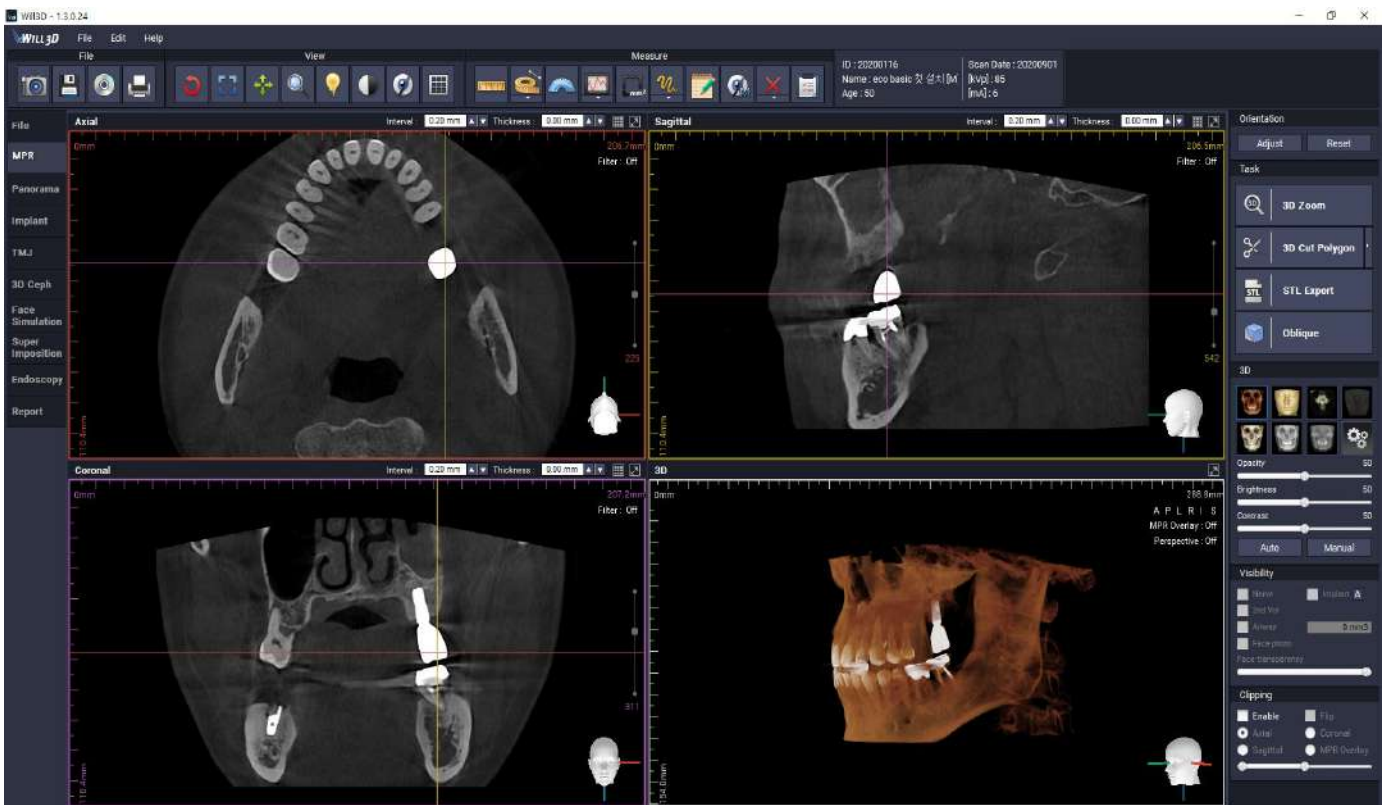

## What are Low Dose CBCT scans used for?

### Postoperative control image

less dose area product than standard panorama protocol

### Determination of tooth position

with CBCT, especially for children and adolescents

### Case-specific application of the program

following the ALARA principle (As Low As Reasonably Achievable)

# Panoramic 2D Imaging crystal clear

The eco-x AI hybrid X-ray system is the perfect solution for professionals who demand nothing but the best. Our innovative auto-focus feature ensures effortless and precise imaging, resulting in stunning 2D images that are both visually stunning and of the highest quality.

Experience the power of our 2.5D multi-layer technology, which allows you to seamlessly scroll through 31 parallel panoramic layers in selected regions, giving you the freedom to manually adjust to the optimal layer for your needs. Don't settle for less - upgrade to eco-x AI and unlock the true potential of your X-ray imaging capabilities today.



## Key facts about the Pano:

- Auto Focus feature for automatic adjustment to the optimal layer
- 2.5D Multi Layer option for retrospective correction of positioning-related errors
- Dedicated low-dose protocols that reduce dose area product by up to 66%

The eco-x AI covers all diagnostic needs for your practice with its 16 different X-ray protocol options. These include:

- Bitewing protocol
- 4 different imaging modes based on patient size (children, small, medium, large)
- Temporomandibular joint (TMJ) protocol
- Sinus protocol for visualization of the paranasal sinuses
- Standard Panorama protocol



# Multi Layer 2.5D for your Pano Scans

The eco-x AI offers the advantages of multi-layered imaging in panoramic scans, in addition to its versatility and efficiency.

With the 2.5D Multi Layer function, you can see up to 31 different layers of the mouth in a single image, providing more detailed and accurate information about the patient's oral health. This can be particularly useful in identifying and diagnosing dental conditions that may not be visible on conventional panoramic X-rays.

The Multi Layer imaging function of eco-x AI can help you provide better care for your patients and make more informed treatment decisions. The multi-layered images can be easily navigated using the user-friendly interface, allowing you to quickly and easily access the necessary information.

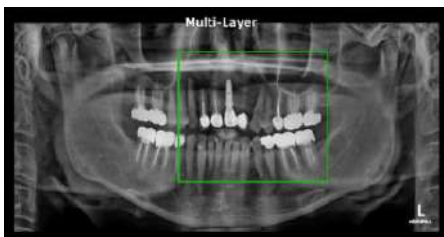

## Select Multi Layer Area

Click and drag with the left mouse button to adjust the area of interest you want to see. Click and drag with the left mouse button to draw the multi-layer area.

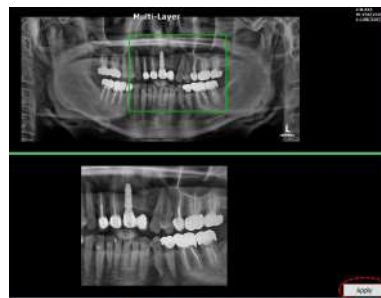

## Add Multi Layer Area

Check the multi-layer image by rotating the mouse wheel in the bottom window. Select the best-focused layer out of a total of 31 layers.

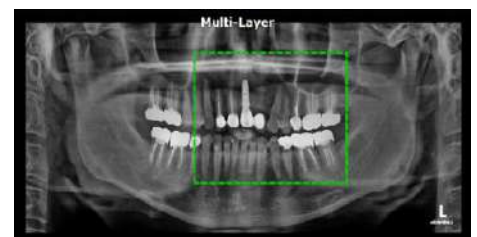

## Apply Multi Layer Area

When you have selected the image of the area of interest from the 31 layers, the chosen layer will be applied to the top window, and the images will be seamlessly blended at the border through natural image processing.

## Auto Focus

The eco-x AI Hybrid X-ray system has been specifically designed to produce high-quality panoramic images of the jaw with automated Auto Focus technology.

By capturing multiple individual shots, the system creates a comprehensive and clear image with the sharpest possible detail. This produces a vivid and sharp panoramic image of the jaw without the need for any manual intervention.

### Schematic Visualization of the Auto Focus function



**Auto Focus OFF** : some areas of an image may appear sharp while others may be blurry and hard to discern. With AF, the entire image is made sharp and of high quality.

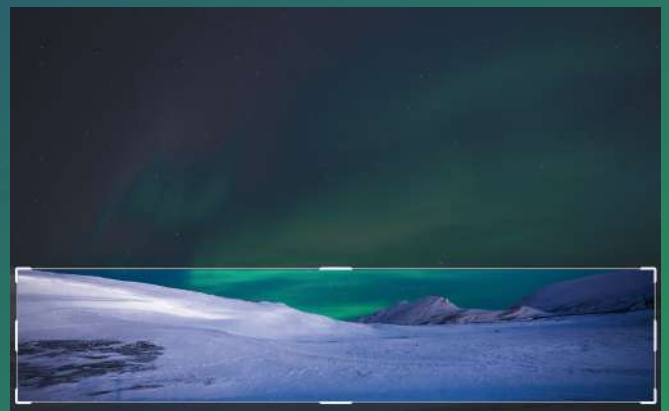
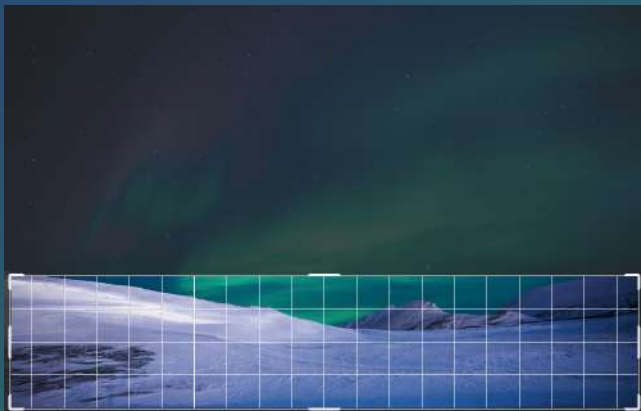

**Auto Focus ON**: Relevant areas of the image are automatically identified from multiple individual shots and blended together seamlessly without any manual intervention, resulting in a sharp and clear panoramic image of the jaw.



# Less is more, even in 2D imaging

## Each protocol with a low dose option

At HDX WILL, we strive to provide X-ray images of the highest quality with our products. In the development of our imaging solutions, we also consider the ALARA principle, which aims to minimize radiation exposure. Our devices offer numerous functions that allow users to reduce radiation dose and ensure that our products are safe and effective.

### Low Dose Panoramic

Low dose Pano reduces the time that a patient is exposed to radiation by up to 50%.

This significantly reduces the overall radiation dose and is particularly valuable for practices that work with children and aim to minimize the radiation exposure of their patients.



### Extraoral Bitewing

With our extraoral imaging program, you can capture images of the posterior and anterior teeth regions with reduced radiation dose and optimized radiation direction.

This program also facilitates working with patients who experience gag reflexes, as it enables you to obtain X-ray images without the need for intraoral X-rays.

# eco-x AI Scan Ceph

## Great value 3-in-1 Solution

Designed to support you with great Ceph analyzing capabilities.

### Great Ceph images with the Scan Ceph

Using the new Auto Landmark mode, the eco-x AI system takes on the cephalometric analysis and swiftly sets all reference points in under a second with a single click before capturing the image.



Along with various CBCT volumes and panoramic programs, eco-x AI offers six modes for all types of Cephalometric imaging:

- Head Lateral
- Head Full Lateral
- Head PA
- SMV (submentovertex)
- Waters View
- Hand

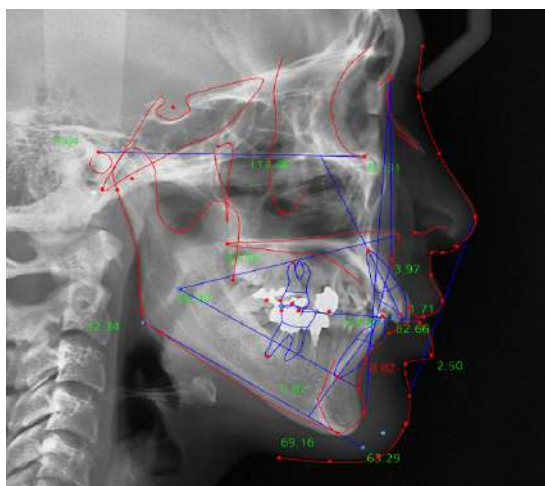
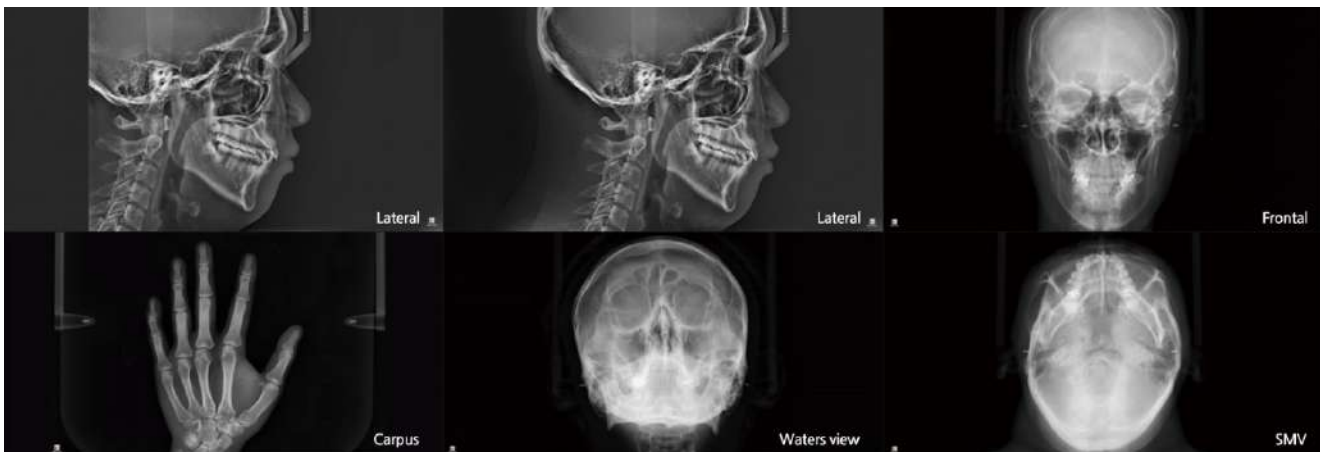

Polygonal Chart McNamara

Post / 2020-08-20 Export Chart

| Results             | Graph                |
|---------------------|----------------------|
| Measure Name        | Mean S.D. 2020/08/20 |
| A point - N Perpend | 1.00 2.70 -7.29 <    |
| Mx1 to A Vertical   | 2.50 0.50 6.94 >     |
| L1 to (A - N perp.) | 5.00 2.23 2.21 <     |
| Pog - N Perpend     | 0.00 3.80 -12.89 <   |
| Facial Axis         | 88.70 2.00 81.93 <   |
| Mandibular Plane    | 30.00 2.00 35.18 >   |
| Mandibular Length   | 128.00 4.20 129.50   |
| Midfacial Length    | 100.00 6.00 86.42 <  |
| ANS-Me. / Nasion-Me | 1.00 0.02 0.51 <     |

Polygonal Chart McNamara

Post / 2020-08-20 Export Chart

| Results             | Graph             |
|---------------------|-------------------|
| A point - N Perpend | -7.29 1.7 3.7     |
| Mx1 to A Vertical   | 2.5 6.94          |
| L1 to (A - N perp.) | 2.21 2.77 7.23    |
| Pog - N Perpend     | -12.89 -3.8 3.5   |
| Facial Axis         | 81.93 86.7 90.7   |
| Mandibular Plane    | 28 35.18          |
| Mandibular Length   | 123.5 123.5 132.2 |
| Midfacial Length    | 86.42 84 105      |
| ANS-Me. / Nasion-Me | 0.51 0.52         |
| Low Ant. Facial Ht. | 70 80 79.88       |

# 3D-Viewer & Analysis with Will3D

With its user-friendly interface and efficient tools, Will3D makes it easy to view, edit, and analyze X-ray images like never before. Will3D simplifies the process and streamlines your workflow, giving you more time to focus on what really matters - your patients.

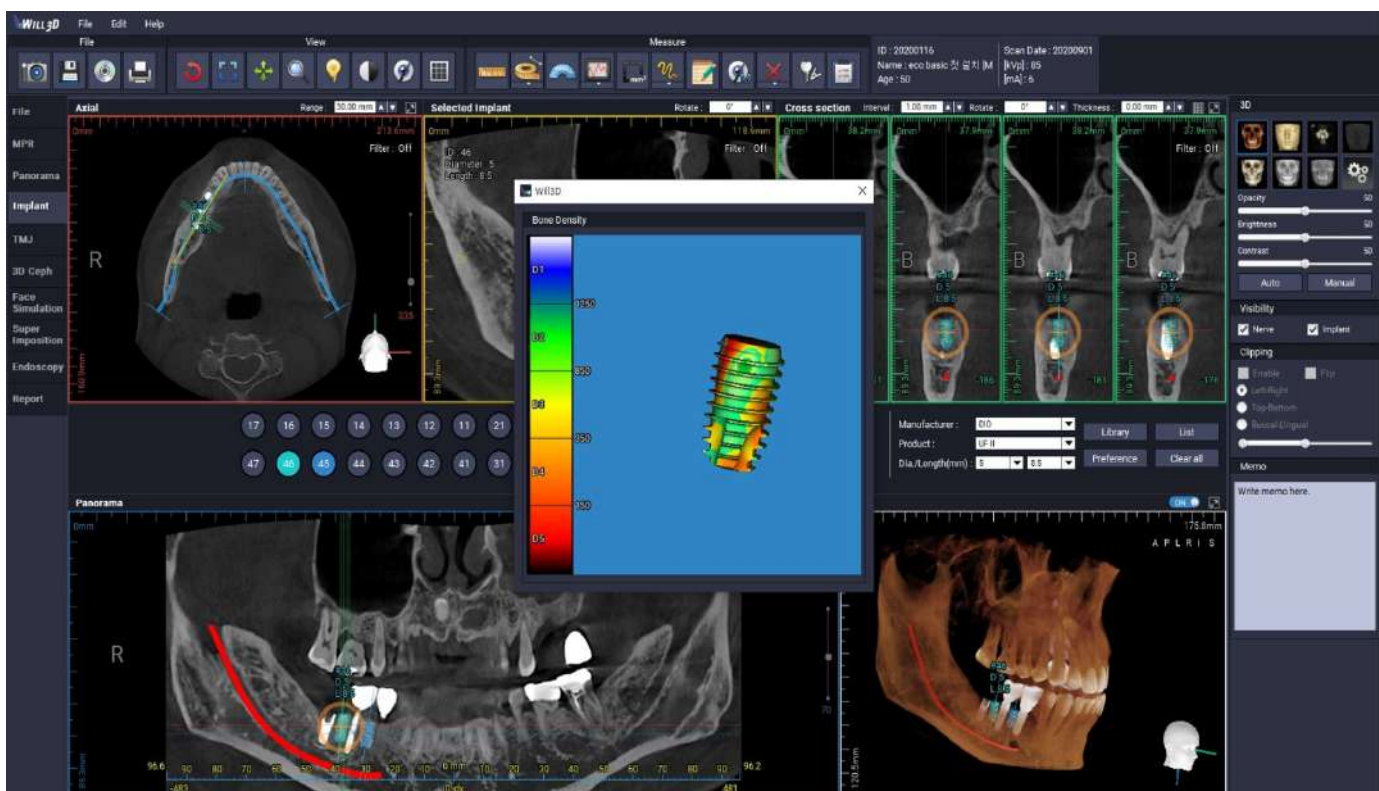

Will3D is a user-friendly and efficient tool for handling digital 2D and 3D X-ray images. With Will3D, capturing, editing, and displaying X-ray images is easy and intuitive. This powerful software allows users to manipulate and analyze X-ray images quickly and easily, helping them make more informed decisions and better serve their patients.

Whether you are a doctor, researcher, or student, Will3D is a valuable tool that can help you achieve your goals. With its intuitive interface and powerful capabilities, Will3D is an essential tool for anyone working with X-ray images.

## Endoscopic View

The endoscopic 3D view can provide valuable information about the location and orientation of the root canals of the tooth, allowing the endodontist to perform treatment more accurately and efficiently.

Furthermore, it can also assist endodontists in diagnosing and treating other conditions that affect the tooth and surrounding tissues, such as abscesses or cysts. By providing a detailed real-time view of the tooth and surrounding structures, it can help endodontists perform root canal treatments and other procedures more accurately and efficiently, ultimately leading to better patient care.

## Easy All In One Solution

Will3D simplifies navigation in the 3D volume by rendering OPG views and automatically positioning the required panoramic curve. The desired slice thickness can be individually selected.

Our software is network-capable and compatible with all common X-ray, scanner, and camera systems via a TWAIN interface.

## Software Key Features

- Precise 3D modeling and visualization
- Support for various imaging modalities
- User-friendly interface and intuitive controls
- Integration with practice management systems
- Flexibility and customization options
- Collaboration features and export function for sharing STL and DICOM datasets with colleagues and patients
- Support for various implant systems and brands.

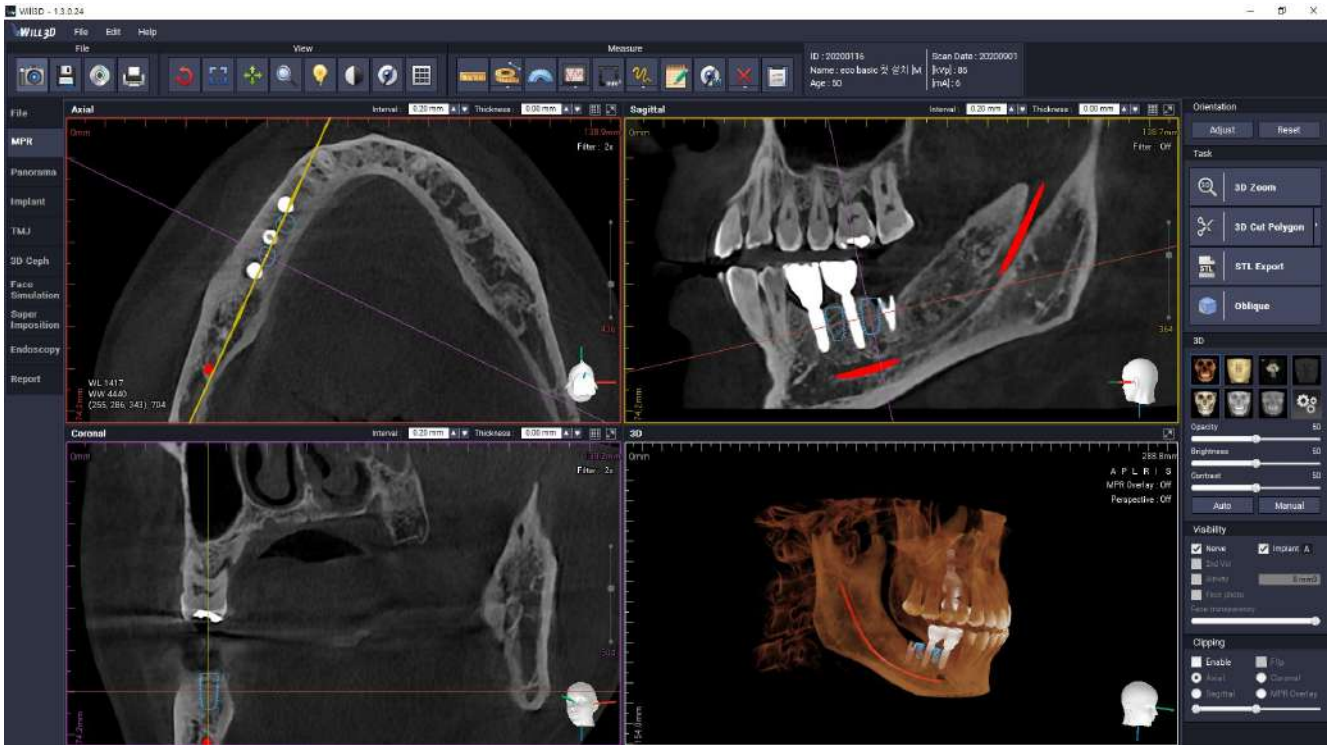

With Will3D, you can easily trace the mandibular nerve canal and verify its correct course using transverse sectional images.

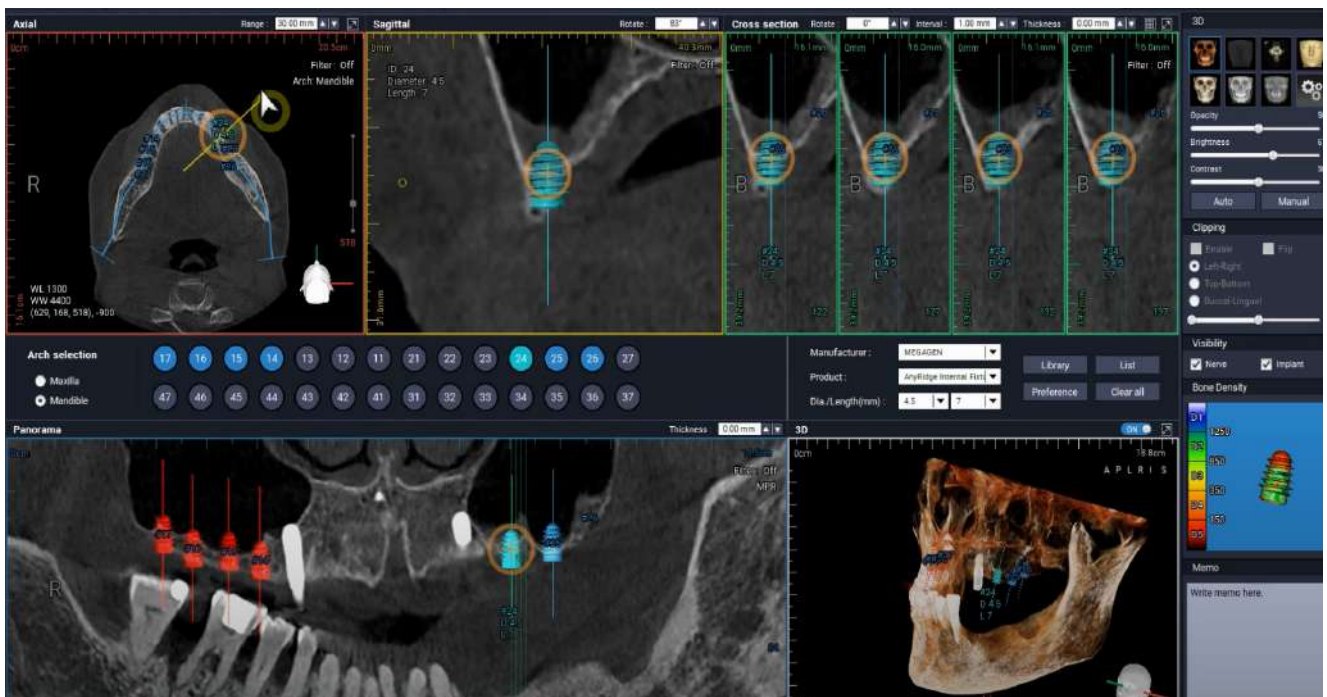

Upper jaw implant planning using a 160 x 90 mm volume image and verification of the bone density.

# Technical Specifications

| eco-x AI                  |                |                               |                          |
|---------------------------|----------------|-------------------------------|--------------------------|
| <b>Generator</b>          |                | <b>Scalable Field of View</b> |                          |
| Voltage                   | 60 - 90 kV     | Free FOV                      | 50 x 50 mm - 120 x 90 mm |
| Current                   | 4 - 10 mA      | <b>3D Volume</b>              |                          |
| <b>Tube</b>               |                | Children                      | 100 x 80 mm              |
| Focal spot                | 0,5 mm         | Adults                        | 120 x 90 mm              |
| Filtration                | 2,5 mm AL      |                               | 160 x 90 mm              |
| <b>Detector</b>           |                | <b>Dimensions</b>             |                          |
| Type                      | TFT:a-Si (CSI) | Height                        | 1614 - 2314 mm           |
| Pixel size                | 119µm          | Weight                        | 178 kg                   |
| A/D (bits)                | 16 bits        | with Ceph: 211 kg             |                          |
| <b>Scan times</b>         |                | Width x depth                 | 980 x 995 mm             |
| Scan times                | 8 - 24 sec     | with Ceph: 1802 x 995 mm      |                          |
| <b>Panoramic Programs</b> |                | <b>Software</b>               |                          |
| Adult protocols           | 15             | 2D Viewer                     | WillMaster               |
| Child protocols           | 9              | 3D Viewer                     | Will3D or OnDemand 3D    |
|                           |                | Ceph Analysis Program         | WillCeph Pro             |

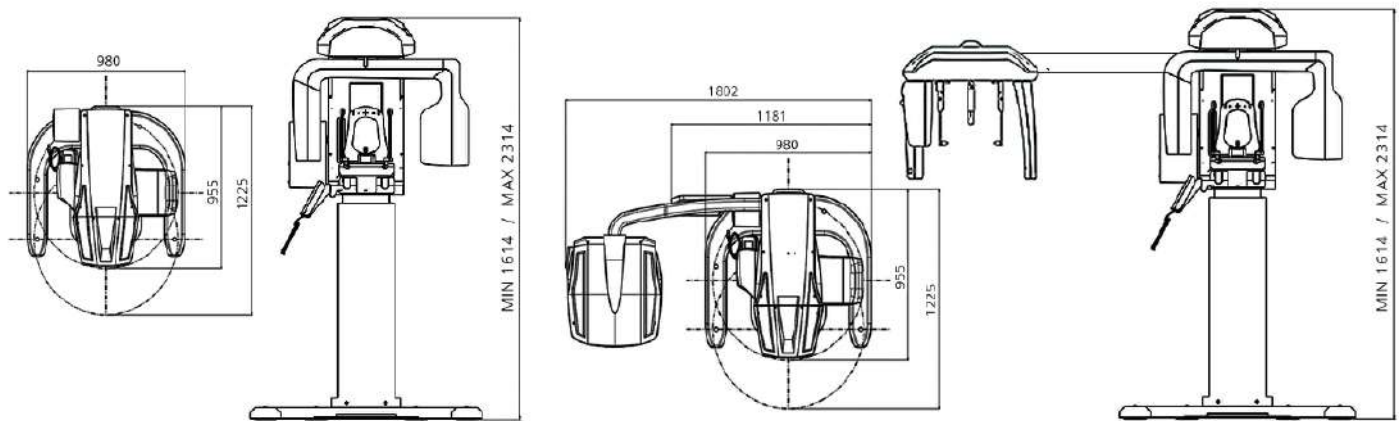

The eco-x AI CBCT system is manufactured in our production facilities in Osong, South Korea, in compliance with strict quality standards.



**1982**  
Establishment of HDX Corp.

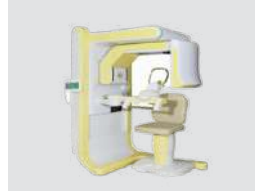

**2010**  
DINNOVA CBCT Launch



**2008**  
Establishment of HDX WILL  
formerly known as Willmed Ltd.

## About HDX WILL Imaging

HDX WILL is a leading South Korean manufacturer of advanced imaging solutions with a focus on CBCT X-ray systems and artificial intelligence.

The HDX Corp., the parent company of HDX WILL, has been operating as a total solution provider for hospitals since 1982.

As a specialist in Imaging, HDX WILL offers 3D imaging systems for dentistry, orthodontics, and ENT. We have our subsidiaries in Germany, South Korea, the USA, China, and Malaysia.



**2012**  
DENTRI CBCT Launch



**2017**  
Q-FACE 5-in-1  
CBCT Launch



**2020**  
eco-x AI CBCT Launch



## HDX WILL Europe Headquarter

HDX WILL Europe GmbH, Hauptstraße 285, 65760 Eschborn, Germany

[info@hdxwill.de](mailto:info@hdxwill.de)

[www.hdxwill.de](http://www.hdxwill.de)

