

Thank you for purchasing Modbus Card. This manual contains instructions and warnings that should be followed during the installation, operating and storage of the card. Please keep this manual for further reference.

Special Precautions

- If the card must be stored prior to installation; storage must be in a dry place
- The admissible storage temperature range is from -10°C to +70°C.

1. Product Overview

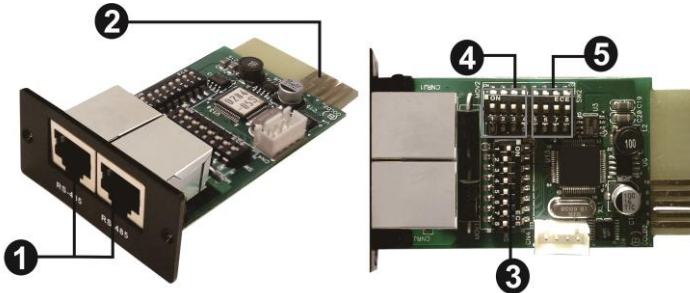

- ❶ RS-485 port
- ❷ Golden finger
- ❸ Address switch
- ❹ Communication setting
- ❺ Resistance switch

2. Product Introduction

The Modbus card provides UPS systems with the functionality of communication with PCs through MODBUS protocol:

- Implements MODBUS RTU protocol
- Provides MODBUS functions including read Holding Registers and write Registers.
- Provides RS485 interface
- Provides surge protection

3. Installation and Operation

Follow below steps to install and use this modbus card:

1. Configure Modbus ID (Refer to section 4.1 for the details)
2. Configure communication format (Refer to section 4.2 for the details)
3. Insert this modbus card into intelligent slot
4. Connect modbus card to computer with RJ45 cable, and it is not necessary to turn the UPS off. (Refer to section 4.5 for the details)

4. Configuration

4.1 Machine ID Configuration

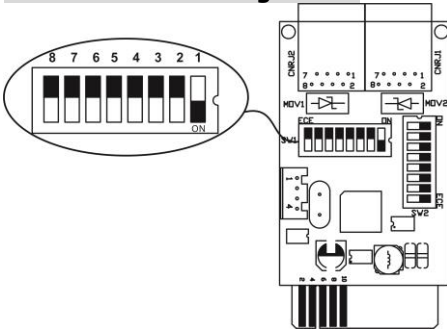

There are eight bits to present ID of each card. Use SW1 to set machine ID. From left to right, it's 8 to 1. As shown, when the switch is pushed down, the bit is set to "one". Otherwise, the bit is set as zero. The ID of modbus card is set to 0x01 as chart. Please check appendix for detailed ID no. and SW1 setting.

4.2 Communication Format Configuration

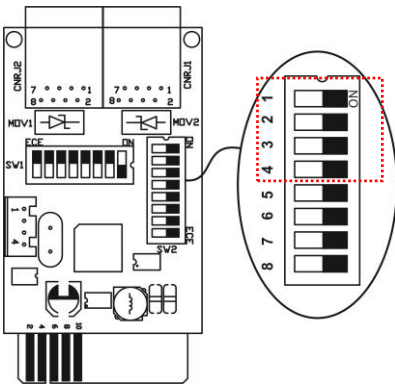

Function	Bit Setting	Meaning
Baud rate	# 2 # 1	
	OFF OFF	2400bps
	OFF ON	4800bps
	ON OFF	9600bps
	ON ON	19200bps(default)
Parity check	# 4 # 3	
	OFF OFF	Even parity
	ON OFF	Odd parity
	OFF ON	No parity check 1 stop bits (Default)
	ON ON	No parity check 2 stop bits

4.3 RS-485 Resistance Configuration

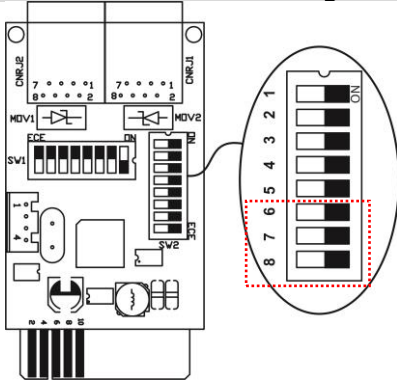

Function	Bit #	Setting	Meaning
Push up resistance	# 6	ON	Enable (Default)
		OFF	Disable
Push down resistance	# 7	ON	Enable (Default)
		OFF	Disable
Terminate resistance	# 8	ON	Enable (Default)
		OFF	Disable

4.4 Interface Configuration

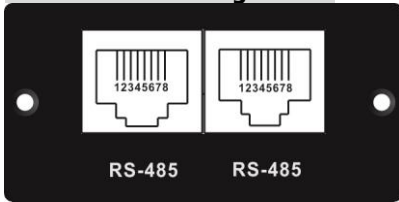

RS-485 Pin Configuration

Pin	Function
4	RS-485 - B
5	RS-485 - A
8	GND

4.5 Connection

First, please use one RS485 to RS 232 converter or RS-485 to Modbus/TCP converter as media converter between Modbus card and computer. Please follow below chart for wiring connection between RJ45 and media converter:

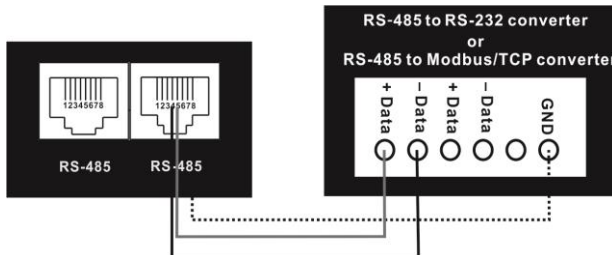

Wiring connection between RJ45 and media converter

Then, follow below diagram to connect personal computer:

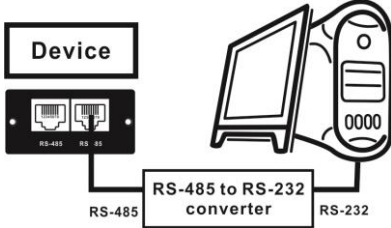

Using RS-485 to RS-232 converter

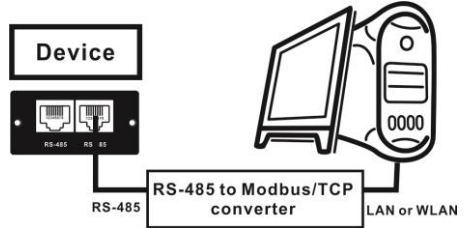

Use RS-485 to Modbus/TCP converter

5. Multiple Monitoring

One modbus card only can be used in one UPS at the same time. When each UPS installed with one modbus card, up to 31 UPSs can be monitored from one computer.

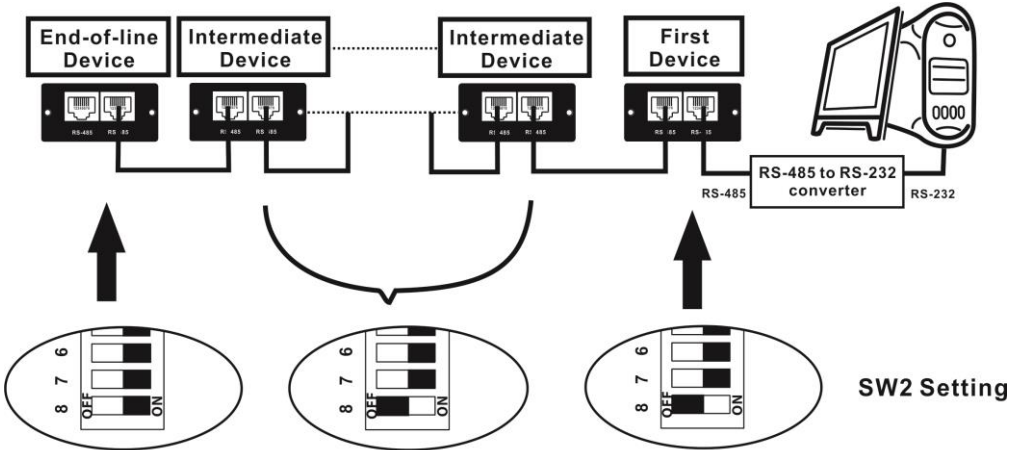

SW2 Setting

End-of-line Device

Bit #	Setting	Meaning
# 6	ON	Enable
# 7	ON	Enable
# 8	ON	Enable

Intermediate Device

Bit #	Setting	Meaning
# 6	ON	Enable
# 7	ON	Enable
# 8	OFF	Disable

First Device

Bit #	Setting	Meaning
# 6	ON	Enable
# 7	ON	Enable
# 8	OFF	Disable

APPENDIX: Machine ID Configuration Table (SW1) √=ON ×=OFF

SW1 ID	Bit 1	Bit 2	Bit 3	Bit 4	Bit 5	Bit 6	Bit 7	Bit 8
1	√	×	×	×	×	×	×	×
2	×	√	×	×	×	×	×	×
3	√	√	×	×	×	×	×	×
4	×	×	√	×	×	×	×	×
5	√	×	√	×	×	×	×	×
6	×	√	√	×	×	×	×	×
7	√	√	√	×	×	×	×	×
8	×	×	×	√	×	×	×	×
9	√	×	×	√	×	×	×	×
10	×	√	×	√	×	×	×	×
11	√	√	×	√	×	×	×	×
12	×	×	√	√	×	×	×	×
13	√	×	√	√	×	×	×	×
14	×	√	√	√	×	×	×	×
15	√	√	√	√	×	×	×	×
16	×	×	×	×	√	×	×	×
17	√	×	×	×	√	×	×	×
18	×	√	×	×	√	×	×	×
19	√	√	×	×	√	×	×	×
20	×	×	√	×	√	×	×	×
21	√	×	√	×	√	×	×	×
22	×	√	√	×	√	×	×	×
23	√	√	√	×	√	×	×	×
24	×	×	×	√	√	×	×	×
25	√	×	×	√	√	×	×	×
26	×	√	×	√	√	×	×	×
27	√	√	×	√	√	×	×	×
28	×	×	√	√	√	×	×	×
29	√	×	√	√	√	×	×	×
30	×	√	√	√	√	×	×	×
31	√	√	√	√	√	×	×	×
32	×	×	×	×	×	√	×	×
33	√	×	×	×	×	√	×	×
34	×	√	×	×	×	√	×	×
35	√	√	×	×	×	√	×	×
36	×	×	√	×	×	√	×	×
37	√	×	√	×	×	√	×	×
38	×	√	√	×	×	√	×	×
39	√	√	√	×	×	√	×	×

40	x	x	x	√	x	√	x	x
41	√	x	x	√	x	√	x	x
42	x	√	x	√	x	√	x	x
43	√	√	x	√	x	√	x	x
44	x	x	√	√	x	√	x	x
45	√	x	√	√	x	√	x	x
46	x	√	√	√	x	√	x	x
47	√	√	√	√	x	√	x	x
48	x	x	x	x	√	√	x	x
49	√	x	x	x	√	√	x	x
50	x	√	x	x	√	√	x	x
51	√	√	x	x	√	√	x	x
52	x	x	√	x	√	√	x	x
53	√	x	√	x	√	√	x	x
54	x	√	√	x	√	√	x	x
55	√	√	√	x	√	√	x	x
56	x	x	x	√	√	√	x	x
57	√	x	x	√	√	√	x	x
58	x	√	x	√	√	√	x	x
59	√	√	x	√	√	√	x	x
60	x	x	√	√	√	√	x	x
61	√	x	√	√	√	√	x	x
62	x	√	√	√	√	√	x	x
63	√	√	√	√	√	√	x	x
64	x	x	x	x	x	x	√	x
65	√	x	x	x	x	x	√	x
66	x	√	x	x	x	x	√	x
67	√	√	x	x	x	x	√	x
68	x	x	√	x	x	x	√	x
69	√	x	√	x	x	x	√	x
70	x	√	√	x	x	x	√	x
71	√	√	√	x	x	x	√	x
72	x	x	x	√	x	x	√	x
73	√	x	x	√	x	x	√	x
74	x	√	x	√	x	x	√	x
75	√	√	x	√	x	x	√	x
76	x	x	√	√	x	x	√	x
77	√	x	√	√	x	x	√	x
78	x	√	√	√	x	x	√	x
79	√	√	√	√	x	x	√	x
80	x	x	x	x	√	x	√	x
81	√	x	x	x	√	x	√	x

82	x	√	x	x	√	x	√	x
83	√	√	x	x	√	x	√	x
84	x	x	√	x	√	x	√	x
85	√	x	√	x	√	x	√	x
86	x	√	√	x	√	x	√	x
87	√	√	√	x	√	x	√	x
88	x	x	x	√	√	x	√	x
89	√	x	x	√	√	x	√	x
90	x	√	x	√	√	x	√	x
91	√	√	x	√	√	x	√	x
92	x	x	√	√	√	x	√	x
93	√	x	√	√	√	x	√	x
94	x	√	√	√	√	x	√	x
95	√	√	√	√	√	x	√	x
96	x	x	x	x	x	√	√	x
97	√	x	x	x	x	√	√	x
98	x	√	x	x	x	√	√	x
99	√	√	x	x	x	√	√	x
100	x	x	√	x	x	√	√	x
101	√	x	√	x	x	√	√	x
102	x	√	√	x	x	√	√	x
103	√	√	√	x	x	√	√	x
104	x	x	x	√	x	√	√	x
105	√	x	x	√	x	√	√	x
106	x	√	x	√	x	√	√	x
107	√	√	x	√	x	√	√	x
108	x	x	√	√	x	√	√	x
109	√	x	√	√	x	√	√	x
110	x	√	√	√	x	√	√	x
111	√	√	√	√	x	√	√	x
112	x	x	x	x	√	√	√	x
113	√	x	x	x	√	√	√	x
114	x	√	x	x	√	√	√	x
115	√	√	x	x	√	√	√	x
116	x	x	√	x	√	√	√	x
117	√	x	√	x	√	√	√	x
118	x	√	√	x	√	√	√	x
119	√	√	√	x	√	√	√	x
120	x	x	x	√	√	√	√	x
121	√	x	x	√	√	√	√	x
122	x	√	x	√	√	√	√	x
123	√	√	x	√	√	√	√	x

124	x	x	√	√	√	√	√	x
125	√	x	√	√	√	√	√	x
126	x	√	√	√	√	√	√	x
127	√	√	√	√	√	√	√	x
128	x	x	x	x	x	x	x	√
129	√	x	x	x	x	x	x	√
130	x	√	x	x	x	x	x	√
131	√	√	x	x	x	x	x	√
132	x	x	√	x	x	x	x	√
133	√	x	√	x	x	x	x	√
134	x	√	√	x	x	x	x	√
135	√	√	√	x	x	x	x	√
136	x	x	x	√	x	x	x	√
137	√	x	x	√	x	x	x	√
138	x	√	x	√	x	x	x	√
139	√	√	x	√	x	x	x	√
140	x	x	√	√	x	x	x	√
141	√	x	√	√	x	x	x	√
142	x	√	√	√	x	x	x	√
143	√	√	√	√	x	x	x	√
144	x	x	x	x	√	x	x	√
145	√	x	x	x	√	x	x	√
146	x	√	x	x	√	x	x	√
147	√	√	x	x	√	x	x	√
148	x	x	√	x	√	x	x	√
149	√	x	√	x	√	x	x	√
150	x	√	√	x	√	x	x	√
151	√	√	√	x	√	x	x	√
152	x	x	x	√	√	x	x	√
153	√	x	x	√	√	x	x	√
154	x	√	x	√	√	x	x	√
155	√	√	x	√	√	x	x	√
156	x	x	√	√	√	x	x	√
157	√	x	√	√	√	x	x	√
158	x	√	√	√	√	x	x	√
159	√	√	√	√	√	x	x	√
160	x	x	x	x	x	√	x	√
161	√	x	x	x	x	√	x	√
162	x	√	x	x	x	√	x	√
163	√	√	x	x	x	√	x	√
164	x	x	√	x	x	√	x	√
165	√	x	√	x	x	√	x	√

166	x	√	√	x	x	√	x	√
167	√	√	√	x	x	√	x	√
168	x	x	x	√	x	√	x	√
169	√	x	x	√	x	√	x	√
170	x	√	x	√	x	√	x	√
171	√	√	x	√	x	√	x	√
172	x	x	√	√	x	√	x	√
173	√	x	√	√	x	√	x	√
174	x	√	√	√	x	√	x	√
175	√	√	√	√	x	√	x	√
176	x	x	x	x	√	√	x	√
177	√	x	x	x	√	√	x	√
178	x	√	x	x	√	√	x	√
179	√	√	x	x	√	√	x	√
180	x	x	√	x	√	√	x	√
181	√	x	√	x	√	√	x	√
182	x	√	√	x	√	√	x	√
183	√	√	√	x	√	√	x	√
184	x	x	x	√	√	√	x	√
185	√	x	x	√	√	√	x	√
186	x	√	x	√	√	√	x	√
187	√	√	x	√	√	√	x	√
188	x	x	√	√	√	√	x	√
189	√	x	√	√	√	√	x	√
190	x	√	√	√	√	√	x	√
191	√	√	√	√	√	√	x	√
192	x	x	x	x	x	x	√	√
193	√	x	x	x	x	x	√	√
194	x	√	x	x	x	x	√	√
195	√	√	x	x	x	x	√	√
196	x	x	√	x	x	x	√	√
197	√	x	√	x	x	x	√	√
198	x	√	√	x	x	x	√	√
199	√	√	√	x	x	x	√	√
200	x	x	x	√	x	x	√	√
201	√	x	x	√	x	x	√	√
202	x	√	x	√	x	x	√	√
203	√	√	x	√	x	x	√	√
204	x	x	√	√	x	x	√	√
205	√	x	√	√	x	x	√	√
206	x	√	√	√	x	x	√	√
207	√	√	√	√	x	x	√	√

208	x	x	x	x	√	x	√	√
209	√	x	x	x	√	x	√	√
210	x	√	x	x	√	x	√	√
211	√	√	x	x	√	x	√	√
212	x	x	√	x	√	x	√	√
213	√	x	√	x	√	x	√	√
214	x	√	√	x	√	x	√	√
215	√	√	√	x	√	x	√	√
216	x	x	x	√	√	x	√	√
217	√	x	x	√	√	x	√	√
218	x	√	x	√	√	x	√	√
219	√	√	x	√	√	x	√	√
220	x	x	√	√	√	x	√	√
221	√	x	√	√	√	x	√	√
222	x	√	√	√	√	x	√	√
223	√	√	√	√	√	x	√	√
224	x	x	x	x	x	√	√	√
225	√	x	x	x	x	√	√	√
226	x	√	x	x	x	√	√	√
227	√	√	x	x	x	√	√	√
228	x	x	√	x	x	√	√	√
229	√	x	√	x	x	√	√	√
230	x	√	√	x	x	√	√	√
231	√	√	√	x	x	√	√	√
232	x	x	x	√	x	√	√	√
233	√	x	x	√	x	√	√	√
234	x	√	x	√	x	√	√	√
235	√	√	x	√	x	√	√	√
236	x	x	√	√	x	√	√	√
237	√	x	√	√	x	√	√	√
238	x	√	√	√	x	√	√	√
239	√	√	√	√	x	√	√	√
240	x	x	x	x	√	√	√	√
241	√	x	x	x	√	√	√	√
242	x	√	x	x	√	√	√	√
243	√	√	x	x	√	√	√	√
244	x	x	√	x	√	√	√	√
245	√	x	√	x	√	√	√	√
246	x	√	√	x	√	√	√	√
247	√	√	√	x	√	√	√	√