



Type(s)
Project
Date
Notes

GENERAL INFORMATION

The High End Systems Ministar is a bright and shining example of reduction without compromising. Ministar’s smaller size contains a broad variety of features all while outputting a blistering 9,700 lumens. Perfect for professionals at small to medium venues and where budget is a top priority, Ministar’s simple feature set includes a ton of variety and flair. Furthermore, the luminaire’s VersaColor capabilities use dual color wheels to create 60 unique colors while QuadraTech can create split and quad color effects for unmatched aerial and projection effects.

Applications

- Nightclubs and concert venues
- Theatre venues
- Cruise ships and themed entertainment
- Houses of worship
- Production rental companies
- Tradeshow and ballroom AV
- Studio and film

Product Features

- Bright white LED engine
- 300 W Ultra-Bright engine
- Fixture output greater than 9,700 lumens
- 6.5°–48° zoom
- VersaColor - 60 unique colors spread across the entire color gamut, organized and presented via a single color control channel
- QuadraTech - Splits the light beam into four distinct colors in 64 different combinations
- Variable Medium diffusion
- Six position plus open rotating gobo wheel with replaceable gobos
- Nine position plus open fixed gobo wheel
- Prism for compound beam and projection effects

ORDERING INFORMATION

Model	Description
MS-UB-MI	Ministar, Black, Ultra-Bright in Molded Insert, Boxed
RC-MS	Road Case, Holds up to Three (3) Ministar Fixtures in Molded Insert

Color Options: Fixtures ship standard in black. White available by request.
Included Accessories: Fixture includes two (2) 107 mm Three-hole Omega brackets, one (1) fixture power cord with bare ends to powerCON® TRUE1® TOP input, and a safety cable.

Accessories

Model	Description
MS-TH	Top Hat, Snoot for Ministar
2500B7029-A	Fixture Power Cord Upgrade, 6 ft TRUE1 TOP to Parallel Blade U-Ground (Edison)
2560B7005	Fixture Power Cord Upgrade, Stage Pin to powerCON TRUE1 TOP, 20 A
2560B7006	Fixture Power Cord Upgrade, L6-20 to powerCON TRUE1 TOP, 20 A
2560B7007	Fixture Power Cord Upgrade, L5-20 to powerCON TRUE1 TOP, 20 A
67040007	MegaClaw™
55040014	Cheeseborough 2" Alloy 1/2 Coupler Truss Clamp
67040010	Mini-Claw™



PRODUCT SPECIFICATIONS

Source

Engine	Ultra-Bright
LED Details	300 W
Field Lumens	See photometrics on page 4
Max Integrating Sphere Lumens	9,700 lumens
LPW	31
LED Life	50,000 hours
Native CCT	7000 K

Color

Color Mixing	60 unique colors mixed via dual color wheels
Color Temperature	8000 K Native, Soft White, Warm White, Neutral White, and Full CTB
Color Wheel	Two wheels with seven (7) colors on each

Optical

Beam Angle Range	6.5°–48°
Gate Size	21 mm
Aperture Size	95 mm
Pattern Projection	- Rotating and indexable wheel with six (6) interchangeable patterns plus open - Fixed wheel with nine (9) non-interchangeable patterns plus open
Prism	Five-facet star rotating prism
Diffusion	Linear insertable medium diffusion
Flicker Control/Hz Range	2.4 kHz and 16 kHz

Control

Input Method	DMX (5-pin)
Protocols	DMX via RS-485
Modes (Footprint)	Standard (31)
RDM Functions	Yes
UI Type	Simple text display with 4-button navigational control
Local Control	Yes
Dimming Performance	16-bit, DMX-controlled

Notes: All LED sources experience some lessening of light output and some color shift over time. LED output will vary with thermal conditions. Thermal conditions can be affected by ambient temperatures and orientation.

Electrical

Voltage Range	100–240 V 50–60 Hz
Input Method	powerCON TRUE1 TOP
Listed Max Wattage	450 W
Current (Max)	4.5 A @ 100 V
Inrush (First Half Cycle)	120 V: 26.8 A 230 V: 120.0 A
Fixtures per Circuit	3 fixtures (15 A power thru connector) 4 fixtures (R20 module or similar) Note: TRUE1 TOP connector rated for 20 A (120 V / 60 Hz) and 16 A (240 V / 50 Hz)

Thermal

Ambient Operating Temp	-10°C–40°C (14°F–104°F)
Fan Mode	Standard, Studio, and Linear Continuous control channel

Physical

Pan and Tilt Range	540° pan, 256° tilt
Max Pan/Tilt Speed	360° in 1.70 s / 180° in 0.96 s
Materials	Steel and aluminum frame with molded plastic covers
Color Options	Black, white by request
Mounting Options	Any orientation
IP Rating	IP20
Weight	16.2 kg (35.7 lb)
Included Accessories	powerCON TRUE1 TOP to bare end fixture tail Two (2) 107 mm, three-hole clamp brackets Safety cable

Warranty

Fixture Warranty	Five (5) years for light engine Two (2) years for complete fixture
Warranty Details	etcconnect.com/Support/Warranty.aspx

Regulatory & Compliance

Approved regulatory standards	cETLus Listed Listed to UL 1573 Certified to CSA STD. C22.2 No: 166 CE Compliant UKCA Compliant
Complies to the ROHS directive	Yes





Safety

Safety	Minimum distance to illuminated surface = 2.0 m (6.6 ft) Minimum distance from fixture head to combustible materials = 0.1 m (4.0 in)
--------	--

FEATURE DETAILS

Rotating Gobo Details

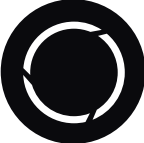
Outside Diameter	30 mm (1.18 in)
Image Diameter	15 mm (0.59 in)
Materials	0.5 mm aluminum 1.1 mm glass Borofloat®

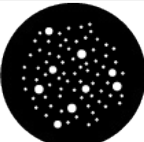
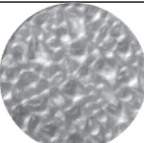
	1 - Bar
	2 - Quadricles
	3 - Broken Tunnel
	4 - Seashell
	5 - Shower
	6 - Ice





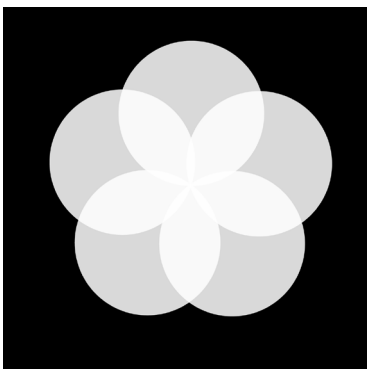

Prism Details

Movement	Prism with five facets
Materials	Molded optical glass



Fixed Wheel Details

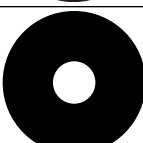
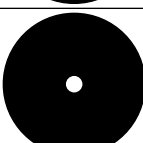

Wheel Diameter	138 mm (5.43 in)
Materials	1.0 mm aluminum

	1 - Shattered
	2 - MiscSpots
	3 - Light Organic
	4 - Thatch
	5 - Across
	6 - Triangles
	7 - Daisey
	8 - Big Dot
	9 - Dot

Fixed Color Wheel Details

Shape	Fixed wedge
Materials	1.1 mm glass Borofloat

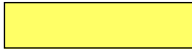
Fixed Color Wheel 1

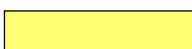
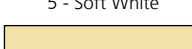
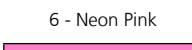
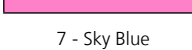
- 1 - Yellow 
- 2 - Light Yellow 
- 3 - Pink 
- 4 - Straw 
- 5 - Soft White 
- 6 - Neon Pink 
- 7 - Sky Blue 

Fixed Color Wheel 2

- 1 - Deep Lavender 
- 2 - Full CTB 
- 3 - Daylight Blue 
- 4 - Azalea 
- 5 - Arctic Blue 
- 6 - Neutral White 
- 7 - Primary Blue 

Utilizing the colors on the fixed color wheels, Ministar achieves 60 unique colors spread throughout the color gamut.

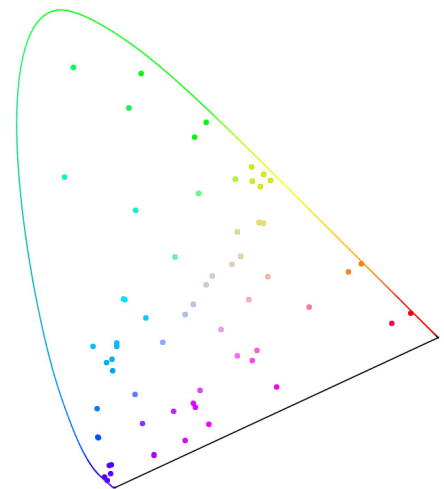

PHOTOMETRIC DATA

Ministar - Ultra-Bright

	Degree	Candela	Field Lumens	Power Usage	Lumens Per Watt
Narrow	6.5°	587,400	3,416	300 W	11
Medium	26°	84,100	9,705	300 W	32
Wide	48°	35,600	8,448	300 W	28

Narrow - 6.5°

Throw Distance	10 ft 3.0 m	20 ft 6.1 m	30 ft 9.1 m	50 ft 15.2 m	200 ft 61 m
Field Diameter	1.1 ft 0.34 m	2.3 ft 0.71 m	3.4 ft 1.04 m	5.7 ft 1.74 m	22.7 ft 6.92 m
Illuminance (fc)	5,874	1,469	653	235	15
Illuminance (lux)	63,200	15,800	7,022	2,528	158

Medium - 26°

Throw Distance	10 ft 3.0 m	20 ft 6.1 m	30 ft 9.1 m	50 ft 15.2 m	200 ft 61 m
Field Diameter	4.6 ft 1.41 m	9.2 ft 2.82 m	13.9 ft 4.23 m	23.1 ft 7.04 m	92.3 ft 28.15 m
Illuminance (fc)	841	211	94	34	3
Illuminance (lux)	9,040	2,260	1,004	362	23

Wide - 48°

Throw Distance	10 ft 3.0 m	20 ft 6.1 m	30 ft 9.1 m	50 ft 15.2 m	200 ft 61 m
Field Diameter	9.3 ft 2.84 m	18.7 ft 5.70 m	28 ft 8.54 m	46.6 ft 14.21 m	186.5 ft 56.85 m
Illuminance (fc)	356	89	40	15	1
Illuminance (lux)	3,828	957	425	153	10

To determine center beam illumination in footcandles at any throw distance, divide candela by the throw distance squared.

Metric conversions: For meters, multiply feet by 0.3048.
For lux, multiply footcandles by 10.76.

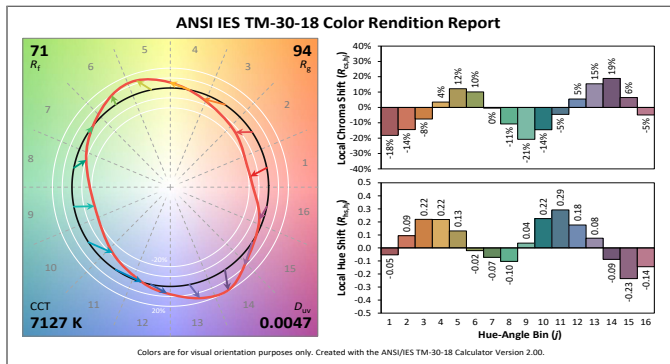

Additional Color Metrics	
CRI R _a (R ₉)	70 (-36)
TLCI	47

Product Dimensions

Model	Height		Width		Depth		Weight	
	in	mm	in	mm	in	mm	lb	kg
Ministar**	21.8	554	14.2	362	8.7	220	35.7	16.2
Ministar in Box with Molded Insert	26.6	676	21.1	536	14.9	378	62.7	28.5

**Does not include mounting hardware

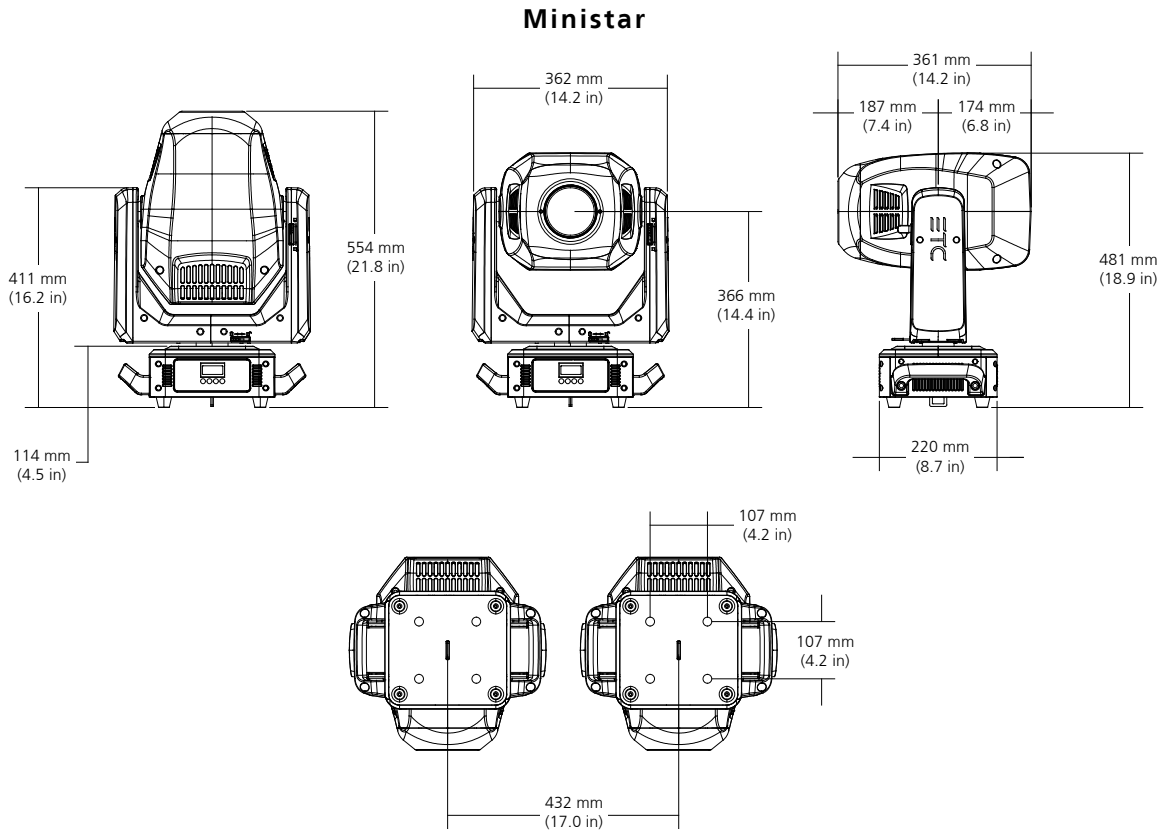

Power Table

VAC	Amps	Hz	Watts	VA	PF
100	4.8	50	480	509	0.99
120	4.0	60	480	497	0.99
200	2.5	50	480	484	0.98
208	2.4	60	480	489	0.97
220	2.3	50	479	491	0.97
230	2.2	50	479	495	0.97
240	2.1	60	473	492	0.95

ADDITIONAL ORDERING INFORMATION

Additional Accessories

Model Number	Description
2599A2000	Omega bracket, 107 mm Three-hole (included)
H7180023	Omega bracket, 107 mm Single-hole
H7300105	Galvanized safety cable with spring snap

Molded Case Insert Dimensions

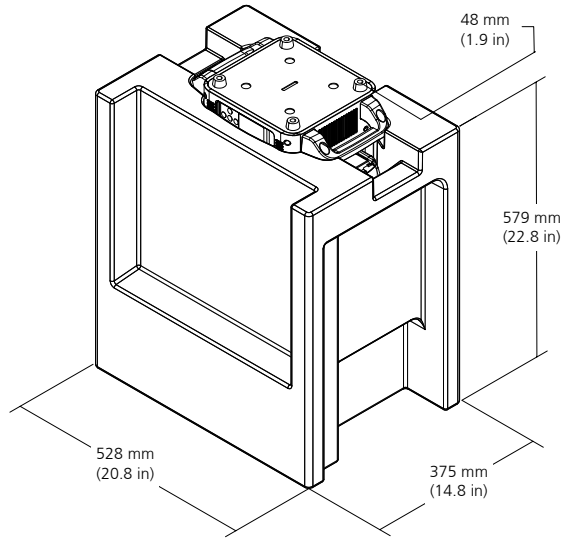

Optional Roadcase Dimensions

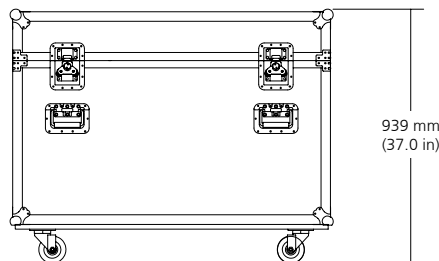
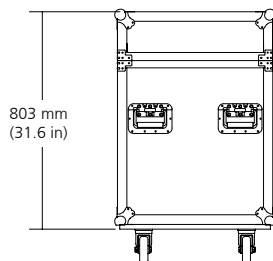
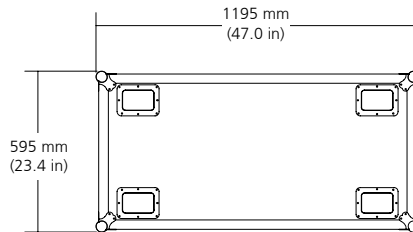

Corporate Headquarters • Middleton, WI USA
 Global Offices • London, UK • Rome, IT • Holzkirchen, DE • Paris, FR • Hong Kong
 Dubai, UAE • Singapore • New York, NY • Orlando, FL • Los Angeles, CA • Austin, TX
 ©2024 ETC. All Rights Reserved. All product information and specifications subject to change. Rev A 2024-01
 *Trademark and patent info: etconnect.com/IP • Third-party license agreement info: etconnect.com/licenses

