

Bocht 15° EW

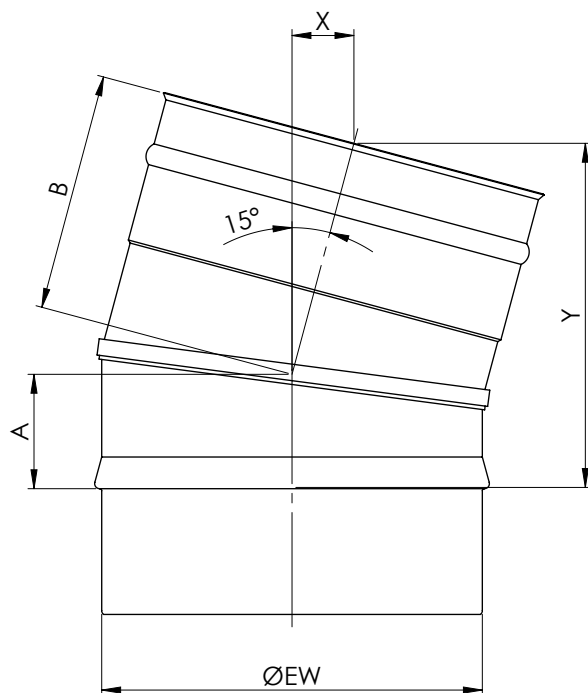

EW	A	B	X	Y
80	40	90	23	127
100	42	92	24	130
110	42	92	24	131
120	43	93	24	133
125	43	93	24	133
130	44	94	24	134
150	45	95	25	137
180	47	97	25	140
200	48	98	25	143
250	51	101	26	149
300	55	105	27	156
350	58	108	28	162
400	61	111	29	169