



LARA DININGBENCH

LARA / ZARA / FRED'S BENCH

01.01.2023

Preisliste

LARA BENCH

offene Naht

	LEDER <u>D</u>	LEDER <u>R</u>	LEDER <u>S</u>	
LARA 3	1'470	1'614	1'731	CHF
LARA 3½	1'656	1'830	1'953	CHF
LARA 4	1'842	2'043	2'139	CHF
LARA 4½	2'055	2'274	2'427	CHF
LARA 5	2'295	2'535	2'709	CHF

ZARA BENCH

"Salsa"-Naht

	STOFF <u>KAT.1</u>	STOFF <u>KAT.2</u>	<u>L.60</u>	
ZARA 3	1'221	1'335	1'335	CHF
ZARA 3½	1'356	1'482	1'482	CHF
ZARA 4	1'482	1'629	1'629	CHF
LARA 4½	1'656	1'815	1'815	CHF
LARA 5	1'854	2'043	2'043	CHF

Nur "Salsa-Naht" möglich, mit Ausnahme von L60 Oklahoma/Colorado und Stoff Hunter

FRED'S BENCH

FdIB Logo im Rücken:

nur lieferbar in Leder Africa

		LEDER <u>S</u>	
FRED'S BENCH	3-Sitz	1'815	CHF
FRED'S BENCH	3½-Sitz	2'052	CHF
FRED'S BENCH	4-Sitz	2'247	CHF
FRED'S BENCH	4½-Sitz	2'550	CHF
FRED'S BENCH	5-Sitz	2'850	CHF

LARA FESTON

nur in Leder und L60!

Mehrpreis 30 p/Sitzplatz

LARA STEPS

Vorderseite Rücke

Mehrpreis 30 p/Sitzplatz

LARA DININGBENCH

3-seater

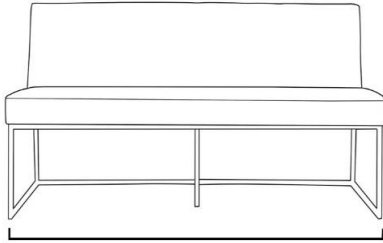

148 cm

3,5-seater

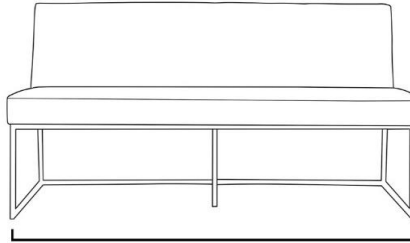

172 cm

4-seater

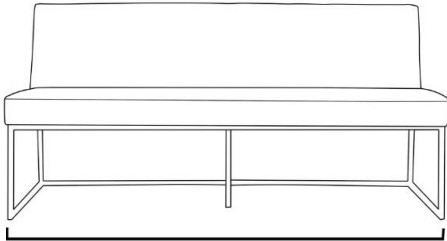

196 cm

4,5-seater

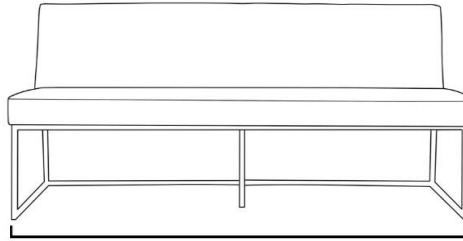

220 cm

5-seater

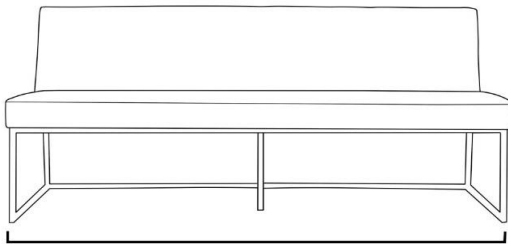

244 cm

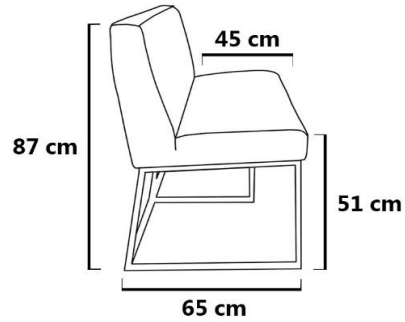

open naad /
open seam /
offene Naht



LARA/ FRED'S

geknepen naad /
pinched seam /
"Salsa-Naht"



ZARA

platgestikt /
flat stitching /
Ebene Naht



LARA/ ZARA

feston stiksel /
feston stitching /
feston Stich



LARA FESTON

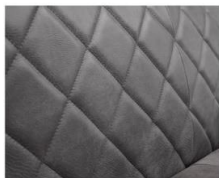

LARA STEPS



RVS-frame of mat-zwart poedercoating
metal frame Stainless steel or powdercoating matt black
gebürstet Edelstahl oder schwarzes Stahl (pulverbeschichtet)

Caution: Using different molds, fabric stitches may differ in fabric with the stitches of the same models in leather
All sizes are approximate, technical and stylistic changes are reserved! Keep typing errors!