



**Product portfolio**

Issue 33

For over 50 years, we have established a reputation for high quality, well designed and manufactured products that protect you and your patients. The increasing amount of business conducted with the industry's major operators is indicative of the quality of our operation.

The after sales service and back up we provide demonstrates our understanding and gives our customers total peace of mind. With the use of high-class efficient suppliers, investment in our design and assembly plant and the ever-increasing emphasis on exhibitions and advertising, we continue to look to the future.

Today, we serve hundreds of companies throughout the world and have established ourselves among the leading manufacturers and suppliers within our field.

We always aim to be the best at what we do.



## Suspension systems

- 2 Track system for overhead shields and lamps**
- 2 3001/TC – Ceiling track and carriage
- 3 Installation aids for shields and lamps**
- 3 300/P/012 – Ceiling void anchorage mount
- 3 300/P/004 – Ceiling mounting plate
- 3 300 – Ceiling column with twin pivots
- 3 Monitor suspension systems**
- 3 333 – Suspension systems for flat screen monitors



## Operating lamps

- 22 Operating and examination lamps**
- 23 LED 130F – Focusable, single colour LED examination lamps
- 23 LED 150F – Focusable, single colour LED examination & small operating lamp
- 23 LED 150FP – Focusable, single colour LED examination & small operating lamp
- 24 LED 150MC – Fixed focus, multi colour LED examination & small operating lamp
- 24 LED 6MC – Multi colour surgical LED lamp
- 24 LED 300DF SC – Single colour surgical LED lamp
- 25 Mobile lamps – LED 130F, 150F, 150FP & 6MC
- 25 Additional sterilisable handle



## X-ray shielding

- 4 Overhead radiation shields**
- 5 354 – Upper body radiation shields - with a patient contour corner cut-out
- 5 354 – Upper body radiation shields - without a corner cut-out
- 5 351 – Upper body radiation shields - with a patient contour corner cut-out
- 5 351 – Upper body radiation shields - without a corner cut-out
- 6 350 – Eyes and thyroid radiation shields
- 6 Overhead radiation shields**
- 6 308 – Overhead flexible lead shield
- 6 Radiation shields and lamps - complete systems**
- 7 350 – Eyes and thyroid shields and lamp combinations
- 7 351 – Upper body shields and lamp combinations
- 7 354 – Upper body shields and lamp combinations
- 8 Mobile radiation shields**
- 8 303 – Mobile protective shield
- 8 310/B-3 – Height adjustable mobile shield
- 8 317 – Flexible protective side panel
- 9 326/05 – Height adjustable over-table shield
- 9 314/05 – Flexible panel mobile shields
- 10 Table mounted lower body shields**
- 11 78 cm wide with a single friction pivot
- 11 89 cm wide with a double friction joint
- 12 92 cm wide with a double friction joint
- 13 100 cm wide with a single friction pivot
- 14 114 cm wide with a double friction joint
- 15 Collision resilient, 92 cm wide with a double friction joint
- 15 Collision resilient, 114 cm wide with a double friction joint
- 16 Collision resilient, 137 cm wide with a double friction joint
- 16 Collision resilient, 137 cm wide with a double friction joint & deep bracket
- 17 Top shield options and replacements
- 19 Wall racks for table mounted lower body shields
- 19 Mobile racks for table mounted lower body shields
- 20 313 – Head end table shields
- 21 311/TC – Upper foot end table shield

- 21 Radiation shielding materials**



## Imaging accessories

- 26 Mobile holders for DR panels and cassettes**
- 26 1330 – Mobile DR detector and cassette holder
- 27 1305/8/1 – Mobile DR detector and cassette holder
- 27 1305/3/1 – Mobile cassette holder
- 27 Positioning aids**
- 27 1701 – Sandbags
- 28 Patients chair**
- 28 1501/D – Patients imaging chair
- 28 Mobile pedestal**
- 28 1340/3 – Mobile pedestal for tableside controls
- 28 1340/3/LR – Mobile pedestal with attached radiation shield



## Protective clothing

- 29 X-ray protective clothing**
- 29 Order guide and colour guide
- 30 907 – LytaType double sided apron
- 31 905 – LytaType wrap-around coat
- 32 903 – LytaType wrap-around coat
- 33 910 – LytaType half back apron
- 34 909 – LytaType cross back apron
- 34 911 – LytaType cross back apron
- 35 915 – LytaType jacket (vest)
- 35 919 – LytaType kilt (skirt)
- 36 917 – LytaType double-sided short top apron
- 36 921 – LytaType demi apron
- 36 921-V – LytaType demi apron
- 37 951/05 – Thyroid collar
- 37 953/05 – Thyroid collar
- 37 278 – Ovary shields
- 37 299 – T shape gonad shields
- 38 265 – Radiation protective glasses
- 38 Apron storage racks**
- 38 100 – Multifunction apron wall console
- 39 102/C – Mobile swivel arm apron rack
- 39 100 – Kilt / skirt hooks
- 39 103 – Mobile apron rail

- 40 Terms and conditions**



LED lamp & 354/P/76-0031

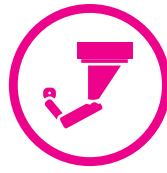

## Suspension systems

Our suspension systems are in use worldwide and safely support numerous medical devices

Including: radiation protective shields, lamps, monitors, contrast injectors, video cameras and x-ray equipment control consoles, either alone or in combination. Customised solutions are also tailored to suit specific requirements.

The sturdy suspension arms used, comprise of a 95 cm or 75 cm extension arm with a 91 cm spring arm, for weight loads up to 21 kg providing movement and flexibility over a wide area. A patented safety collar prevents separation of the supported device, while the design of the twin pin steel ceiling column ensures the maximum level of safety when the assembly of one or two devices is stationary mounted on the ceiling, or attached to the carriage in our ceiling track.

Our patented ceiling track has a unique profile that holds an optional cable management system, where signal and supply cables are enclosed within an integrated energy chain. This arrangement eliminates the need for an unsightly cable festoon system where external sliding cable hangers restrict movement. The enhanced strength of the track enables two independently movable carriages to be incorporated with each carrying a ceiling column with two fully loaded suspension arms.

Systems are UL classified, manufactured for safety and essential performance to international standard IEC 60601-1 3rd Edition, and CE certified to EU Regulation 2017/745 concerning medical device.



## Track system for overhead shields and lamps Model 3001

### 3001/TC – Ceiling track and carriage (new track design patented by Kenex)

Please note: model 3001/TC/250 track and carriage is included with some radiation shields. See product codes ending -0031 on pages 5 and 6 and other devices on page 7.

Heavy duty aluminium tracks supplied with a smooth running carriage.

- Shields with a ceiling column, i.e., 354/P/76-001 can be fixed to a carriage.
- 2 carriages can be fitted to provide independent movement of up to 4 devices.
- Optional cable management system (energy chain) for lamps or monitors etc.
- The cable management fits tidily within the track and eliminates hanging cables.
- Design simplifies installation to Unistrut (or equivalent) ceiling channels.

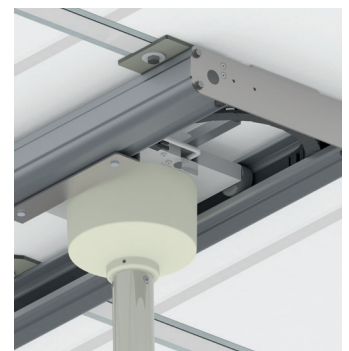

3001/TC track with cable management (energy chain)  
(Attached vertical column not included)

Description	Product code
250 cm long ceiling track including 1 carriage	3001/TC/250
420 cm long ceiling track including 1 carriage	3001/TC/420
<b>Optional extras</b>	
Extra carriage (maximum 2 per track)	3001/3.25
Energy chain (per carriage) for 250 cm long tracks	3001/TC/250/EC
Energy chain (per carriage) for 420 cm long tracks	3001/TC/420/EC



# Installation aids for shields and lamps

## Model 300

### 300/P/012, 300/P/014 – Ceiling void anchorage mounts

These support structures are designed for installation in the space between a suspended ceiling and a solid ceiling above (column not included).

- Once assembled, installed and adjusted they provide an upright and solid platform.

Description	Product code
Ceiling void anchorage mount for distances between 30 cm - 90 cm	300/P/012
Ceiling void anchorage mount for distances between 8.5 cm - 30 cm	300/P/014



300/P/012



300/P/014

### 300/P/004 – Ceiling mounting plate

This mounting plate provides an effective support for the static installation of the ceiling column supplied with shields, lamps and monitor suspension systems.

- The plate can be fixed above or below a suspended ceiling.

Description	Product code
73.5 x 34 x 3.8 cm steel mounting plate (column not included)	300/P/004

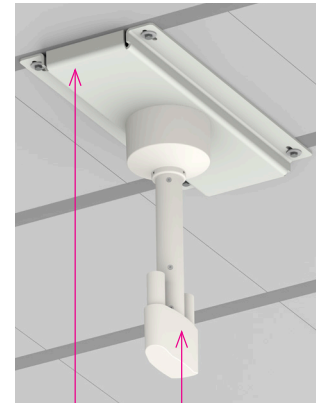

300/P/004

Ceiling column

### 300 – Ceiling column with twin pivots

Description	Product code
80 cm long + 1 pivot electrically wired for arm and lamp	300/COLUMN-2
Other lengths 40, 60 and 100 cm with the same specification	300/COLUMN/40 or 60, 100

# Monitor suspension systems

## Model 333

### 333 – Suspension systems for flat screen monitors with a 5-10 kg weight range

- 186 cm reach extension/spring arm and monitor holder with 100 mm VESA mount.
- Supplied with 80 cm long twin pivot column with 60 or 100 cm lengths available.
- External cabling only.

Description	Product code
<b>Stationary system</b> Monitor holder, suspension arm and fixed ceiling column	333/1/510/001
<b>Ceiling track system</b> Monitor holder, arm, column, 250 cm track & carriage	333/1/510/0031
<b>Wall mounted system</b> Monitor holder, arm and wall fixing bracket	333/1/510/005
<b>Combined system</b> Monitor holder and arm, fit onto an existing ceiling column	333/1/510/006



333/1/510/0031

Model 333/1/510/001 can be used with an existing track. Model 333/1/510/006 can be used with a shield.



## X-ray shielding

Our comprehensive range of x-ray shielding equipment significantly reduces secondary radiation exposure to staff during all applications.

The installation of ceiling suspended lead acrylic or lead glass shields minimise dose to the head, lens of the eye and upper body, and importantly provide instant access to the patient in an emergency. Tableside mounted shields protect the lower body and extremities and when combined, provide a safe and effective zone of occupancy. Mobile over-table and alongside table versions are also available.

3D Computer-aided design (CAD) files to assist with room planning and layout are available on request.



354/P/76-001

## Overhead radiation shields Models 354/351/350/308

**Kenex radiation shields - provide optimal protection**

### Stationary installation

Protective shields for static installation on the ceiling are supplied with a suspension arm and an 80 cm long ceiling column as standard, with other lengths of 40 cm, 60 cm and 100 cm available. The suspension arm comprises an extension and spring arm combination with a combined reach of 186 cm. The ceiling column has a spare pivot, equipped with an internal electrical connector, for mounting a second suspension arm and another device; such as the lamp illustrated.

### Movable installation

Shields for guidance across the ceiling are additionally supplied with a 250 cm long heavy duty aluminium ceiling track with a movable carriage. Track mounted devices can be moved and positioned in the working area or parked up to 5.9 meters away. An optional second carriage provides independent movement of further attached devices, such as injectors, monitors, lamps or extra shields.



354/P/76/LED130F-0031

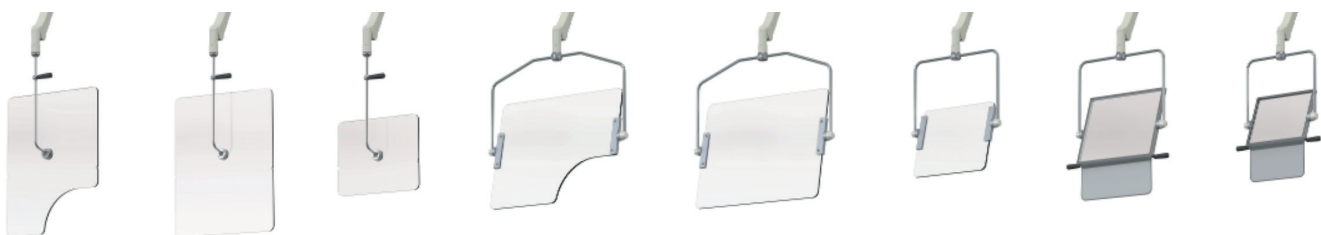

## 354 – Upper body radiation shields

### With a patient contour corner cut-out

- Material: transparent lead acrylic, lead equivalent 0.5 mm.
- Portrait orientation, but central ball and socket joint provides rotational and tilting movement.

Description	Product code
76 cm high x 61 cm wide shield with a suspension arm and ceiling column	354/P/76-001
76 x 61 cm shield with arm, column and 250 cm heavy duty aluminium ceiling track	354/P/76-0031
<b>Option:</b> flexible 0.5 mm lead panels fitted around lower profile	354/P/LR



354/P/76-001

354/P/LR

## 354 – Upper body radiation shields

### Without a corner cut-out

- Material: transparent lead acrylic, lead equivalent 0.5 mm.
- Portrait orientation, but central ball and socket joint provides rotational and tilting movement.

Description	Product code
76 cm high x 61 cm wide shield with a suspension arm and ceiling column	354/76-001
76 x 61 cm shield with arm, column and 250 cm heavy duty aluminium ceiling track	354/76-0031
<b>Option:</b> flexible 0.5 mm lead panels fitted across 61 cm width	354/LR/61
40 cm high x 50 cm wide shield with a suspension arm and ceiling column	354/45-001
40 x 50 cm shield with arm, column and 250 cm heavy duty aluminium ceiling track	354/45-0031
<b>Option:</b> flexible 0.5 mm lead panels fitted across 50 cm width	354/LR/50



354/76-001

## 351 – Upper body radiation shields

### With a patient contour corner cut-out

- Material: transparent lead acrylic, lead equivalent 0.5 mm.
- Landscape orientation.

Description	Product code
60 cm high x 80 cm wide shield with a suspension arm and ceiling column	351/P/68-001
60 x 80 cm shield with arm, column and 250 cm heavy duty aluminium ceiling track	351/P/68-0031
<b>Option:</b> flexible 0.5 mm lead panels fitted around lower profile	351/P/LR



351/P/68-001

## 351 – Upper body radiation shields

### Without a corner cut-out

- Material: transparent lead acrylic, lead equivalent 0.5 mm.
- Landscape orientation.

Description	Product code
60 cm high x 80 cm wide shield with a suspension arm and ceiling column	351/68-001
60 x 80 cm shield with arm, column and 250 cm heavy duty aluminium ceiling track	351/68-0031
<b>Option:</b> flexible 0.5 mm lead panels fitted across 80 cm width	351/LR/80
40 cm high x 50 cm wide shield with suspension arm and ceiling column	351/45-001
40 x 50 cm shield with arm, column and 250 cm heavy duty aluminium ceiling track	351/45-0031
<b>Option:</b> flexible 0.5 mm lead panels fitted across 50 cm width	351/LR/50



351/68-001

## > Overhead radiation shields continued

### 350 – Eyes and thyroid radiation shields

- Material: Lead glass, with minimum 2.2 mm lead equivalent.
- Fitted flexible lower curtain: lead equivalent 0.5 mm.

Description	Product code
40 cm high x 50 cm wide shield with a suspension arm and ceiling column	350/45-001
40 x 50 cm shield with arm, column and 250 cm heavy duty alloy ceiling track	350/45-0031
30 cm high x 40 cm wide shield with a suspension arm and column	350/34-001
30 x 40 cm shield with arm, column and 250 cm heavy duty alloy ceiling track	350/34-0031



350/45-001

### 308 – Overhead flexible lead shield

Overlapping panels with a fold-up centre section retained by a press stud.

- Material: flexible 0.5 mm Pb equivalent lead vinyl.
- Size: 50 cm high x 100 cm wide.
- Ceiling model has an 80 cm long ceiling column. 60 & 100 cm lengths are optional.

Other sizes available on request.

Description	Product code
Shield with a suspension arm and ceiling column	308/50100-001
Shield with a suspension arm and wall mounting bracket	308/50100-005



308

For track systems please see page 2.

## > Radiation shields and lamps - complete systems Models 350/351/354

### Static ceiling mounted or ceiling track mounted radiation shields and lamp combinations

All our lamps have daylight characteristics, light field focussing, dimming with on/off switch, sterilisable handle, power supply unit and a 950/910 mm suspension arm. Model 350 protective shields include a 2.2 mm lead equivalent glass window with an attached 0.5 mm Pb flexible curtain. Models 351 and 354 shields include 0.5 mm lead equivalent transparent acrylic with an optionally attached 0.5 mm Pb flexible curtain.

All shields are supplied with a suspension arm and an 80 cm long twin pivot ceiling column as standard. Other lengths of 40 cm, 60 cm and 100 cm are available as a no cost option.

See page 4 for further shield details and page 22 for lamps. For mounting systems please see page 2 and 3.

## 350 – Eyes and thyroid shields and lamp combinations

### Stationary system: with a fixed ceiling column

Description	Product code
40 x 50 cm shield, static column and lamp: LED 130F	350/45/LED130F-001
40 x 50 cm shield, static column and lamp: LED 150F	350/45/LED150F-001
40 x 50 cm shield, static column and lamp: LED 300DF SC	350/45/LED3DF-001

### Movable solution: with ceiling column and 250 cm HD aluminium ceiling track

Description	Product code
40 x 50 cm shield, column, ceiling track and lamp: LED 130F	350/45/LED130F-0031
40 x 50 cm shield, column, ceiling track and lamp: LED 150F	350/45/LED150F-0031
40 x 50 cm shield, column, ceiling track and lamp: LED 300DF SC	350/45/LED3DF-0031



350/45/LED130F-0031

## 351 – Upper body shields and lamp combinations

### Stationary system: with a fixed ceiling column

Description	Product code
60 x 80 cm shield, static column and lamp: LED 130F	351/P68/LED130F-001
60 x 80 cm shield, static column and lamp: LED 150F	351/P68/LED150F-001
60 x 80 cm shield, static column and lamp: LED 300DF SC	351/P68/LED3DF-001

### Movable solution: with ceiling column and 250 cm HD aluminium ceiling track

Description	Product code
60 x 80 cm shield, column, ceiling track and lamp: LED 130F	351/P68/LED130F-0031
60 x 80 cm shield, column, ceiling track and lamp: LED 150F	351/P68/LED150F-0031
60 x 80 cm shield, column, ceiling track and lamp: LED 300DF SC	351/P68/LED3DF-0031



351/P68/LED130F-0031

## 354 – Upper body shields and lamp combinations

### Stationary system: with a fixed ceiling column

Description	Product code
76 x 61 cm shield, static column and lamp: LED 130F	354/P76/LED130F-001
76 x 61 cm shield, static column and lamp: LED 150F	354/P76/LED150F-001
76 x 61 cm shield, static column and lamp: LED 300DF SC	354/P76/LED3DF-001

### Movable solution: with ceiling column and 250 cm HD aluminium ceiling track

Description	Product code
76 x 61 cm shield, column, ceiling track and lamp: LED 130F	354/P76/LED130F-0031
76 x 61 cm shield, column, ceiling track and lamp: LED 150F	354/P76/LED150F-0031
76 x 61 cm shield, column, ceiling track and lamp: LED 300DF SC	354/P76/LED3DF-0031



354/P76/LED130F-0031

For operating lamps please see page 22.

# Mobile radiation shields

## Models 303/310/317/326/314

### 303 – Mobile protective shield

Solid panel design: 2.2 mm lead core faced in high-pressure plastic laminate and edged in white impact resistant ABS thermoplastic edging. Available in six different colours, all with 2.2 mm Pb equivalent clear lead glass window.

#### Standard mobile shields

Fitted with 30 cm high x 40 cm wide window, available in landscape or portrait format.

Description	Product code
Standard shield 200 cm high x 75 cm wide	303/B2/75
Standard shield 200 cm high x 90 cm wide	303/B2/90

#### Panoramic mobile shield

Fitted with 60 cm high x 90 cm wide window

Description	Product code
Panoramic shield 200 cm high x 90 cm wide	303/B3/90



303/B2/90

303/B3/90

### 310/B-3 – Height adjustable mobile shield

Original Kenex design exceeds the demands of professionals.

- Ideal for use in confined areas close to the tableside.
- The counterbalanced lead acrylic window can be raised in an instant or lowered to gain access to the patient.
- Optional full width rail can be used for equipment hand controls.
- Occupies very little space when not in use.

Window 70 cm wide (0.5 mm Pb equivalent): height range 115 - 188 cm.

Lower steel panel 78 cm wide (1.0 mm Pb equivalent).

Description	Product code
Height adjustable shield	310/B-3
Shield 310/B-3 with rail 10 x 25 x 769 mm	310/B-3/31
Shield 310/B-3 with rail 8 x 25 x 769 mm	310/B-3/91



310/B-3

### 317 – Flexible protective side panel

A flexible curtain on a double-jointed pivotal arm can be factory fitted to the side, or to both sides of the above mobile shield model 310/B-3.

- One curtain, when fully extended increases the shield width by 68 cm.
- Pivotal arm and curtain can swivel round to form a curved side wing.
- Flexible 0.5 mm curtain is 85 cm long.
- Curtain folds across the front when not in use.

Description	Product code
Protective side panel (per side)	317/05-01



317

## 326/05 – Height adjustable over-table shield

All the attributes of ceiling and table mounted shields in one mobile unit.

- Creates a safe working zone.
- Significantly reduces exposure to radiation.
- The counterbalanced lead acrylic window can be positioned over the patient and height adjusted to suit the table.
- A flexible curtain is suspended from the cantilevered window and does not impede C-arm movements.
- The lower sliding curtain may be extended towards the tableside to form a continuous barrier.

Window: 50 x 116 cm, 0.5 mm Pb equivalent, height range 138-168 cm.

Curtain: 45 - 80 cm wide x 80 cm high (0.5 mm Pb equivalent).

Description	Product code
Over-table mobile shield	326/05



326/05



## 314/05 – Flexible panel mobile shields

Mobile panel is height adjustable with spring assistance.

- Height range: 85 cm to 120 cm.
- Single flexible panel model is 70 cm wide x 60 cm high.
- Double panel version has fixed extra protection below.
- Lead equivalent: 0.5 mm.

Description	Product code
Single flexible panel mobile shield	314/05-01
Double flexible panel mobile shield	314/05-02



314/05-01



314/05-02



# Table mounted shields

## Model 312/E & 312/DS

### Table mounted lower body shields

Shields have either a double-jointed pivotal arm or a single friction pivotal arm. Both can be moved laterally towards the patient or swivelled away from the table to form a 0.5 mm Pb protective wing. All have self-adjusting friction joints ensuring that the shield remains in the desired position.

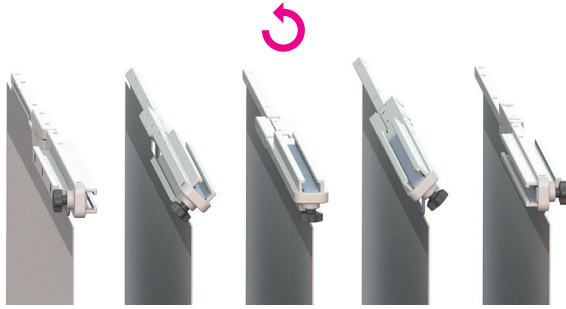

- Kenex table shields can be moved from one side of the table to the other in an instant by simply rotating the upper part 180° horizontally. The pivotal arm always faces the head end.
- To position a table shield, slide the attachment bracket onto the table's table-side accessory rail (please refer to product pages for compatibility).
- All shields have an automatic wear adjustment facility ensuring accurate joint friction preventing unwanted curtain movement even when the table is tilted in any direction.
- The suspended curtain forms a single 'safe zone of occupancy' for the Radiologist (or Cardiologist). This can be extended by the use of top shields.
- The curtain forms around an under table x-ray tube without impeding movement.
- When used in conjunction with Kenex ceiling mounted systems, both upper & lower body protection meet to provide an effective & easy to use barrier to scatter radiation.

#### Curtain construction

The flexible curtain suspended from each shield provides 0.5 mm Pb protection. It consists of a flexible inner layer with a durable outer covering bonded to it. This results in an extremely strong, supple, easy to clean curtain which cannot delaminate. All shields are supplied with a curtain which easily forms around a C-Arm without impeding C-Arm movement.

#### Alternative construction

Shields with curtains made using three overlapping panels are available to special order – Add '/P' to the end of the required stock code. Shields with overlapping panels are a no cost option.

#### Top shields

Kenex top shields are manufactured using the same 0.5 mm Pb protective material as the suspended curtains of the main shield. They include a flexible plastic material that enables them to stand 25 cm above the table-side rail, and provide additional higher and wider protection to the user. Their unique shape (wider at the top) ensures that no gaps develop as the adjacent tops are pushed towards the patient during procedures. (see page 17)



312/E-022



Side profile showing attachment

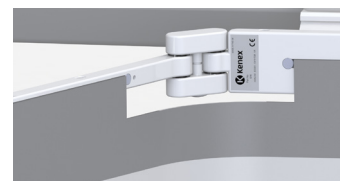
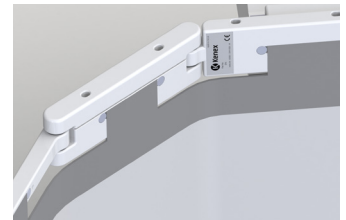

Automatic wear adjustment



Top shields



## 78 cm wide with a single friction pivot

- 78 cm shields can be quickly adjusted to fit either a 25 mm high or 29 mm tableside accessory rail.
- 70 cm high curtain.

Description	Product code
One piece table shield with a 57 cm wide lift-off top shield	312/E-006
Alternative model with overlapping curtain panels	312/E-006/P
One piece table shield without a top shield	312/E-005
Alternative model with overlapping curtain panels	312/E-005/P

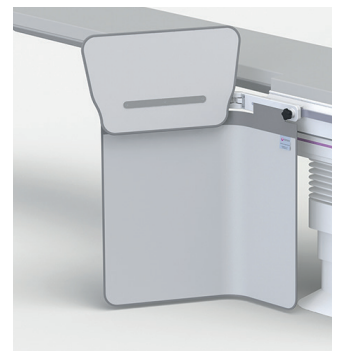

312/E-006



312/E-006



312/E-006/P



312/E-005



312/E-005/P

## 89 cm wide with a double friction joint

- 89 cm shields fit onto a 25 mm high tableside rail.
- 70 cm high curtain.

Description	Product code
Table shield with overlapping curtain panels and a 52 cm wide fold-down top shield	311/DS-020



311/DS-020

## > Table mounted shields continued

### 92 cm wide with a double friction joint

- 92 cm shields fit onto a 25 mm high table side rail, but can be quickly adjusted on site to fit a 29 mm table side accessory rail.
- 70 cm high curtain.

Description	Product code
One piece table shield with a 57 cm wide fold-down top shield	312/E-012
Alternative model with overlapping curtain panels	312/E-012/P
One piece table shield with a 57 cm wide lift-off top shield	312/E-011
Alternative model with overlapping curtain panels	312/E-011/P
One piece table shield without a top shield	312/E-010
Alternative model with overlapping curtain panels	312/E-010/P
Two piece collision resilient shield with a 57 cm lift-off top*	312/E-013
Alternative model with overlapping curtain panels	312/E-013/P



312/E-012

\*The pivotal arm of 312/E-013 moves up if struck from below by a C-arm. See page 15.



312/E-012



312/E-012/P



312/E-011



312/E-011/P



312/E-010

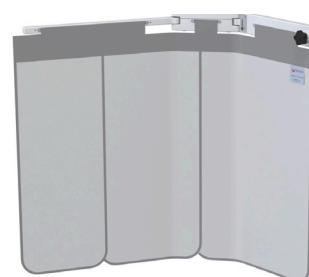

312/E-010/P



312/E-013



312/E-013/P

## 100 cm wide with a single friction pivot

- All 100 cm shields have a 35 cm long accessory rail to keep equipment controls close to hand and the curtain behind provides extra protection. The rail is available in two sizes.
- These shields can also overhang the tableside rail to be positioned nearer the head end.
- The attachment bracket slides onto a 25 mm high tableside accessory rail (max. 11 mm depth).
- 70 cm high curtain.

Description	With 350 x 10 x 25 mm accessory rail	With 350 x 7.7 x 25 mm accessory rail
One piece table shield with a 57 cm wide lift-off top shield	312/E-016	312/E-016/8
Alternative model with overlapping curtain panels	312/E-016/P	312/E-016/8P
One piece table shield without a top shield	312/E-015	312/E-015/8
Alternative model with overlapping curtain panels	312/E-015/P	312/E-015/8P



312/E-016



312/E-016



312/E-016/P



312/E-015



312/E-015/P

## Table mounted shields continued

### 114 cm wide with a double friction joint

- All 114 cm shields have a 35 cm long accessory rail to keep equipment controls close to hand and the curtain behind provides extra protection. The rail is available in two sizes.
- These shields can also overhang the tableside rail to be positioned nearer the head end.
- The attachment bracket slides onto a 25 mm high tableside accessory rail (max. 11 mm depth).
- 70 cm high curtain.



312/E-022

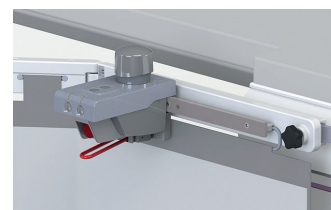

Accessory rail

Description	With 350 x 10 x 25 mm accessory rail	With 350 x 7.7 x 25 mm accessory rail
One piece table shield with a 57 cm wide fold-down top shield	312/E-022	312/E-022/8
Alternative model with overlapping curtain panels	312/E-022/P	312/E-022/8P
One piece table shield with a 57 cm wide lift-off top shield	312/E-021	312/E-021/8
Alternative model with overlapping curtain panels	312/E-021/P	312/E-021/8P
One piece table shield without a top shield	312/E-020	312/E-020/8
Alternative model with overlapping curtain panels	312/E-020/P	312/E-020/8P
Two piece collision resilient shield with a 57 cm lift-off top*	312/E-023	312/E-023/8
Alternative model with overlapping curtain panels	312/E-023/P	312/E-023/8P

\*The pivotal arm of 312/E-023 moves up if struck from below by a C-arm. See page 15.



312/E-022



312/E-022/P



312/E-021



312/E-021/P

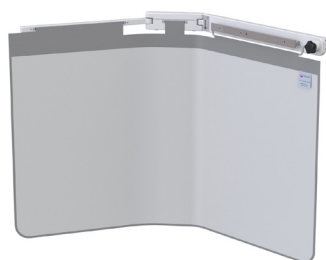

312/E-020

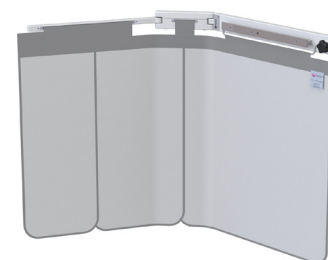

312/E-020/P



312/E-023



312/E-023/P

# Table mounted shields, collision resilient

## Model 312/E & 312/DS

### Collision resilient table mounted lower body shields

Unique patented mechanism enables the pivotal arm to move up when in collision with C-arm equipment.

- All models have a double-jointed pivotal arm supporting a protective 0.5 mm lead equivalent flexible curtain.
- The pivotal arm and curtain can move up when a C-arm is in contact from below.
- The curtain can move laterally close to the tableside or swivel away to form a protective wing.

### 92 cm wide collision resilient with a double friction joint

- Fits onto 25 mm high tableside rails or can be configured on site for 29 mm high rails.
- Can be fitted to either sides of the table, with the pivotal arm always positioned towards the head end.
- 70 cm high curtain.

Description	Product code
Collision resilient shield with 57 cm wide lift-off top	312/E-013
Alternative model with overlapping curtain panels	312/E-013/P



312/E-013



312/E-013/P

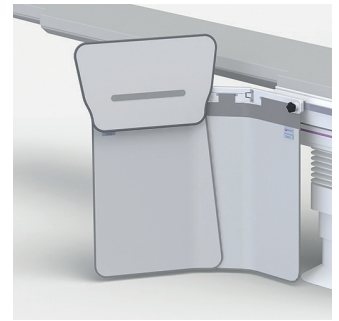

312/E-013

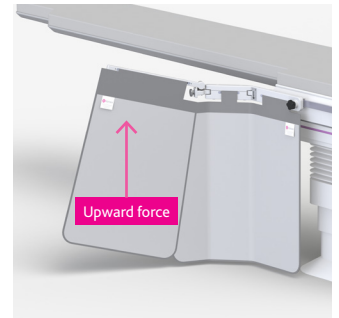

312/E-013 with top shield removed

### 114 cm wide collision resilient with a double friction joint

- Fitted with a 35 cm long rail for equipment controls.
- The attachment bracket slides onto a 25 mm high tableside accessory rail (max. 11 mm depth).
- Provides extra protection behind attached equipment controls.
- Can be fitted to either sides of the table, with the pivotal arm always positioned towards the head end.
- 70 cm high curtain.

Description	With 350 x 10 x 25 mm accessory rail	With 350 x 7.7 x 25 mm accessory rail
Collision resilient shield with 57 cm wide lift-off top	312/E-023	312/E-023/8
Alternative model with overlapping curtain panels	312/E-023/P	312/E-023/8P



312/E-023



312/E-023/P

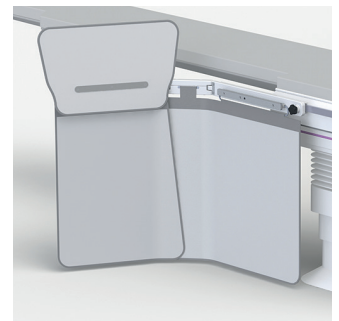

312/E-023

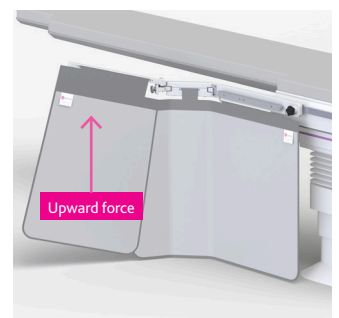

312/E-023 with top shield removed

## > Table mounted shields, collision resilient continued

### 137 cm wide collision resilient with a double friction joint

- All 137 cm shields have a 57 cm long accessory rail to keep equipment controls close to hand and the curtain behind provides extra protection.
- The attachment bracket slides onto a 25 mm high tableside accessory rail (max. 11 mm depth).
- These shields can also overhang the tableside rail to be positioned nearer the head end.
- 75 cm high curtain.

Description	With 570 x 10 x 25 mm accessory rail
Collision resilient table shield	312/DS-039/5
Including set of three top shields (3 x lift-off)	312/DS-0412/5
Collision resilient table shield with additional accessory rail 28.6 x 9.8 mm	312/DS-039/6
Including set of three top shields (1 x fold-down/lift-off & 2 x lift-off)	312/DS-039/6/3

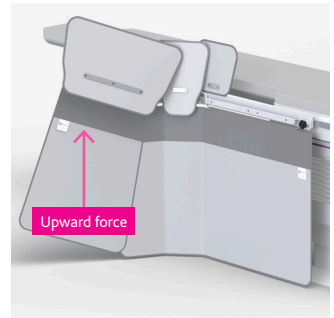

312/DS-039/6/3

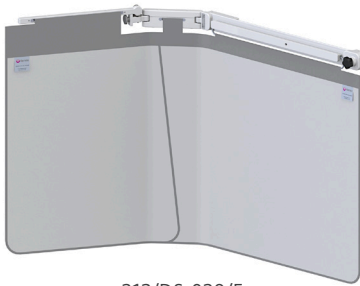

312/DS-039/5

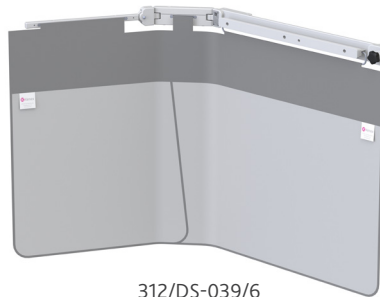

312/DS-039/6



312/DS-039/6/3

### 137 cm wide collision resilient with a double friction joint and deep attachment bracket

- Patented deep attachment bracket allowing transverse table movement
- 57 cm long accessory rail to keep equipment controls close to hand and the curtain behind provides extra protection.
- The attachment bracket slides onto a 25 mm high tableside accessory rail (max. 11 mm depth).
- These shields can also overhang the tableside rail to be positioned nearer the head end.
- 75 cm high curtain.

Description	With 650 x 10 x 25 mm accessory rail
Collision resilient table shield with deep attachment bracket, additional accessory rail 28.6 x 9.8 mm	312/DS-060
Including set of three top shields (1 x fold-down/lift-off & 2 x lift-off)	312/DS-060/1/3

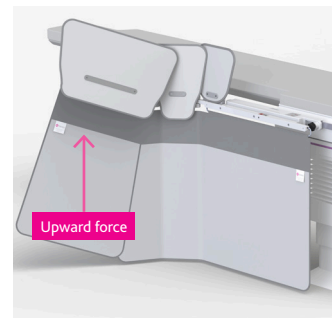

312/DS-060/1/3

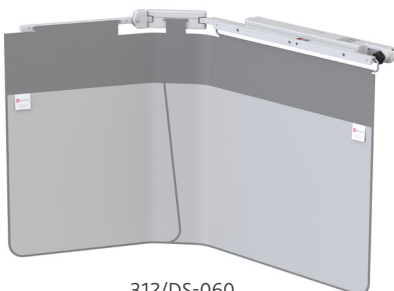

312/DS-060



312/DS-060/1/3



# Table mounted shields, top shields

## Model 312/DS

### For use on Kenex lower body shields

Top shields quickly and easily attach to different table mounted Kenex lower body radiation shields, providing additional protection to the user (see separate datasheet for compatibility). Some table shields come with one or more top shields but these are available as optional extras.

- Removeable, 0.5mm Pb X-ray protective top shields
- Slot into docking holes and can be mounted and removed in an instant.
- Standard height tops stand 25 cm above the centre line of the table side rail, reduced height tops are 10 cm shorter and stand 15 cm above.
- Most can be stored on a wall rack when not required (available separately, see page 19).

#### Additional upper protection

57 cm wide tops used together with 27 cm wide tops provide the following total upper protection:-

Description	upper protection width
57 cm wide top only	57 cm wide
57 cm wide top with 1 x 27 cm wide top	74 cm wide
57 cm wide top with 2 x 27 cm wide top*	92 cm wide

78 cm table shields can only accommodate 1 x 57 cm and 1 x 27 cm top shield.

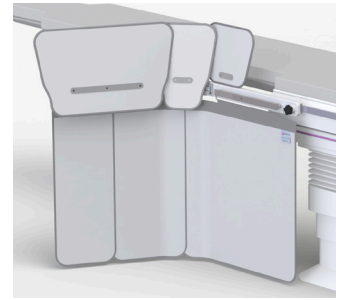

312/E-021/P

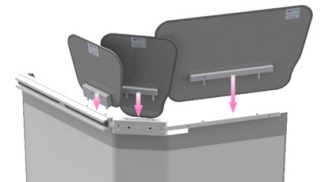

Slot into docking holes

### 312 – Top shield sets

- Top shields are flexible and stand 25 cm above the table side rail. Reduced height top shields stand 15 cm above.
- 27 and 57 cm wide shield combinations give up to 92 cm wide upper protection.

Description	Product code
Standard height, set of three lift-off top shields. Compatible with 312/E-020, 312/E-021, 312/E-022, 312/DS-039/1 & variants.	312/E/025
Reduced height, set of three lift-off top shields. Compatible with 312/E-020, 312/E-021, 312/E-022, 312/DS-039/1 & variants.	312/E/027
Reduced height, set of three lift-off top shields. Compatible with 312/E-023, 312/DS-039/2 & 312/DS-039/5.	312/E/024



312/E/025



312/E/027



312/E/024

## Table mounted shields, top shields continued

### 312/DS – 57 cm wide top shield options and replacements

- Top shields are flexible and stand 25 cm above the table side rail. Reduced height top shields stand 15 cm above.
- For compatibility see separate top shield data sheet.

#### Standard height top shields

Description	Product code
57 cm wide, standard height, lift-off top	312/DS/3.32
57 cm wide, standard height, fold-down top, not removable	312/DS/3.33
57 cm wide, standard height, fold-down / lift-off top	312/DS/3.115
57 cm wide, standard height, lift-off top for collision resilient shields	312/DS/3.32/3

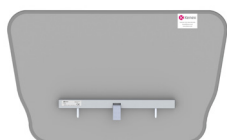

312/DS/3.32



312/DS/3.33



312/DS/3.115



312/DS/3.32/3

#### Reduced height top shields

Description	Product code
57 cm wide, reduced height, lift-off top	312/DS/3.128
57 cm wide, reduced height, fold-down top, not removable	312/DS/3.139
57 cm wide, reduced height, fold-down / lift-off top	312/DS/3.167
57 cm wide, reduced height, lift-off top for collision resilient shields	312/DS/3.106



312/DS/3.128



312/DS/3.139



312/DS/3.167



312/DS/3.106

### 312/DS – 27 cm wide top shield options and replacements

- Top shields are flexible and stand 25 cm above the table side rail. Reduced height top shields stand 15 cm above.
- For compatibility see separate top shield data sheet.

#### Standard height top shields

Description	Product code
27 cm wide, standard height, lift-off top	312/DS/3.30
27 cm wide, standard height, lift-off top (cropped)	312/DS/3.41
27 cm wide, standard height, lift-off top (cropped)	312/DS/3.122



312/DS/3.30



312/DS/3.108



312/DS/3.41



312/DS/3.110

#### Reduced height top shields

Description	Product code
27 cm wide, reduced height, lift-off top	312/DS/3.108
27 cm wide, reduced height, lift-off top (cropped)	312/DS/3.110
27 cm wide, reduced height, lift-off top (cropped)	312/DS/3.130



312/DS/3.122



312/DS/3.130



# Table mounted shields, top shields Model 312/DS

## Wall racks for table mounted lower body shields

These racks provide a convenient storage location when shields are removed from the table side.

Description	Product code
Wall rack for a lower body shield	312/W-LB
Wall rack for 1 x 57 cm wide top shield and 2 x 27 cm wide top shields (excluding fold down)	312/W-TOP

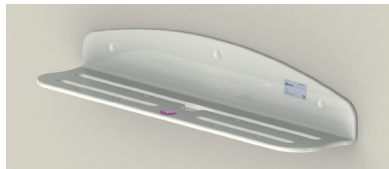

312/W-TOP



312/W-LB



312/W-TOP (above)  
312/W-LB (below)

Suspension systems

X-ray shielding

## Mobile racks for table mounted lower body shields

Effective mobile storage combinations for lower body table shields (types 311 & 312), removable Kenex top shield sets (1 x 57 cm and 2 x 27 cm wide) and optional head end shields (types 313).

Description	Product code
Mobile rack for 1 x table shield, 1 x set of top shields and 1 x head end shield	1342/A2/E
Mobile rack for 2 x table shields and 2 x sets of top shields	1342/A2/F



1342/A2/E  
Shields not included



1342/A2/F  
Shields not included

Operating lamps

Operating lamps

Imaging accessories

Imaging accessories

Protective clothing

Protective clothing

# Table mounted shields head end

## Model 313

These lower body shields substantially reduce exposure to scatter radiation emanating from the table or patient's body. They comprise of a lightweight and durable structure supporting a flexible 0.5 mm lead equivalent curtain or multiple curtains.

- The shield slides onto a carbon fibre table top and maintains its position even when the table is tilted.
- The pivotal side wings can be formed around the user, individually extended forward along the table side, or folded neatly away according to preference. The pivotal arms can be quickly repositioned to allow full C-arm movement.
- Each shield is manufactured to suit a specific table and can be provided with an optional wall storage rack if not already included. This allows the shield arms to be folded inwards to reduce wall space to a minimum.

Please specify size and make of table when ordering.

A downloadable pdf measurement sheet is available on our website or by request.

### 313/A2

56 cm wide central section and two 32 cm wide pivotal side wings, supporting an 80 cm long flexible 0.5mm Pb equivalent curtain. Total width: 120 cm (dependent upon make of table).

Description	Product code
Head end table shield	313/A2
Optional wall rack	On request
Head end table shield & wall rack for use with a 525 mm wide Artis table or 520 mm wide TruSystem 7500 for Artis zee systems	313/A2-001
Head end table shield & wall rack for use with a 550 mm wide Artis zee multipurpose (MP) table	313/A2-008

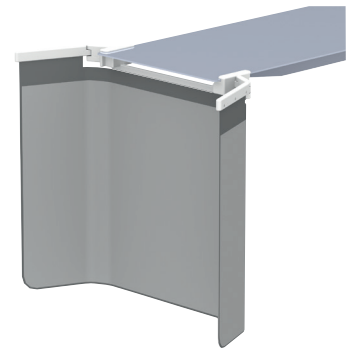

313/A2

### 313/A3

57 cm wide central section and two 31 cm wide pivotal side wings, supporting an 80 cm long flexible 0.5mm Pb equivalent curtain. The flexible 57 cm wide x 27 cm high top shield folds down when required.

Description	Product code
Head end table shield and flexible 57 cm wide x 27 cm high fold down top shield for use with a 500 mm wide Allura AD7 table	313/A3-001
Optional wall rack	313/A3-001/W



313/A3-001

Top shield shown folded down

# Table mounted shields upper foot end Model 311

## 311/TC – Upper foot end table shield

This shield protects against scatter radiation and also helps protect against possible blood splashes during some interventional procedures.

- Designed for use across the table towards the foot end.
- Fits onto both 25 mm high table side accessory rails (7.7 - 10 mm thick).
- Lead acrylic window 60 cm high x 80 cm wide (dependent on table width), with lower flexible curtain.
- Overall height: 90 cm.
- Lead equivalent protection throughout: 0.5 mm.

Please specify size and make of the table.  
A downloadable pdf measurement sheet is available on request.



311/TC/004

Description	Product code
Table end upper shield	311/TC/004

# Radiation shielding materials Models 320/323/325

Description	Product code
<b>Flexible lead vinyl sheeting</b>	
0.5 mm Pb equivalent 95 cm wide. Price per linear metre	320/K/050/96
<b>Lead glass – clear optical quality 2.2 mm Pb equivalent.</b>	
30 x 40 cm	323/Z/3040
40 x 50 cm	323/Z/4050
Larger sizes up to 100 x 200 cm	
<b>Clear lead acrylic (plastic).</b>	
0.5 mm Pb equivalent (12 mm thick)	325/054

Other Pb values for the above materials are also available.

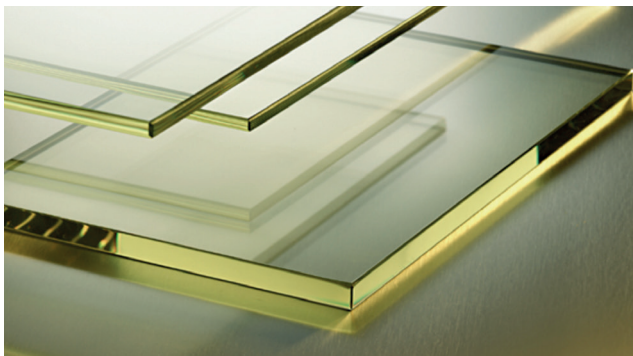

Lead glass

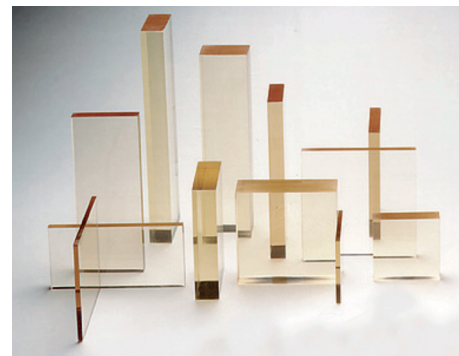

Lead acrylic



## Operating lamps

### Our modern ergonomic lamps create ideal examination and operating conditions

Such as daylight characteristics, cool light technology with almost non-existent heat dispersion, faceted multi-lenses for even illumination, high contrast colour rendering for recognition of colour tones and controls to alter the light field size and intensity. LED MC models enable the colour temperature values to be altered to create a range of settings according to preference or application. For example 4500 or 4750 Kelvin for cold-white or warm-white light.



LED 300DF SC

## Operating and examination lamps

Lamps can be used in combination with radiation shields or separately, either as a static installation or as a movable unit in a ceiling track.

Outstanding illumination with high-contrast daylight characteristics, optimal colour reproduction and cool light technology are features of these examination and surgical lamps. Robust suspension arms, comprising a 95 cm extension with a 91 cm spring arm, provide extensive reaching capacity within a 372 cm diameter and a height adjustment of 118 cm. Mobile versions are available.



LED 130F



LED 150F, LED 150FP & LED 150MC



LED 6MC



LED 300DF SC

## LED 130F – Focusable, single colour LED examination lamp

Light output 70,000 Lux

- Colour rendering index Ra 96, colour temperature 4500K and focusable light field 13-19 cm diameter.
- Diming range 50% to 100% with on/off switch at lamp head.
- 19 LED's (life span 60,000h) included in 33 cm diameter lamp head with sterilisable handle.
- Supplied with a separate power supply unit (100-240V 50-60Hz) and housing.

Description	Product code
LED 130F lamp and suspension arm only (for use with a Kenex ceiling radiation shield)	300/L-LED130F
LED 130F lamp, suspension arm and ceiling column	300/CL-LED130F
LED 130F lamp, suspension arm and wall fixing bracket	300/WL-LED130F



LED 130F

## LED 150F – Focusable, single colour LED examination and small operating lamp

Light output 110,000 Lux

- Colour rendering index Ra 96, colour temperature 4500K and focusable light field 18-25 cm diameter.
- Diming range 50% to 100% with on/off switch at lamp head.
- 26 LED's (life span 60,000h) included in 40 cm diameter lamp head with sterilisable handle.
- Supplied with a separate power supply unit (100-240V 50-60Hz) and housing.

Description	Product code
LED 150F lamp and suspension arm only (for use with a Kenex ceiling radiation shield), incl. power supply	300/L-LED150F
LED 150F lamp, suspension arm and ceiling column, includes power supply	300/CL-LED150F
LED 150F lamp, suspension arm and wall fixing bracket, includes power supply	300/WL-LED150F



LED 150F

### Lamp Upgrade

A 150F lamp head with LED technology, can replace an existing Kenex 130F lamp head, or older Triaflex lamp head, (with halogen bulbs), without the need to replace their existing suspension arms. LED 150F light output: 100,000 LUX.

Description	Product code
LED 150F lamp head with separate electronic transformer (110-250V 50-60Hz) and housing	150F/400/3.1

## LED 150FP – Focusable, single colour LED examination and small operating lamp

Light output 130,000 Lux

- Colour rendering index Ra 96, colour temperature 4500K and focusable light field 17-24 cm diameter.
- Diming range 50% to 100% with on/off switch at lamp head.
- 26 LED's (life span 60,000h) included in 40 cm diameter lamp head with sterilisable handle.
- Supplied with a separate power supply unit (100-240V 50-60Hz) and housing.

Description	Product code
LED 150FP lamp and suspension arm only (for use with a Kenex ceiling radiation shield), incl. power supply	300/L-LED150FP
LED 150FP lamp, suspension arm and ceiling column, includes power supply	300/CL-LED150FP
LED 150FP lamp, suspension arm and wall fixing bracket, includes power supply	300/WL-LED150FP



LED 150FP

Additional sterilisable handle available for all lights see page 25.

## › Operating and examination lamps continued

### LED 150MC – Fixed focus, multi colour LED examination and small operating lamp

Light output 110,000 Lux

- Colour rendering index Ra 96, colour temperature range: 3750, 4000, 4250, 4500 & 4750 Kelvin and 20 cm light field diameter.
- Diming range 50% to 100% with on/off switch at lamp head.
- 26 LED's (life span 60,000h) included in 40 cm diameter lamp head with sterilisable handle.
- Supplied with a separate power supply unit (100-240V 50-60Hz) and housing.

Description	Product code
LED 150MC lamp and suspension arm only (for use with a Kenex ceiling radiation shield), incl. power supply	300/L-LED150MC
LED 150MC lamp, suspension arm and ceiling column, includes power supply	300/CL-LED150MC
LED 150MC lamp, suspension arm and wall fixing bracket, includes power supply	300/WL-LED150MC



LED 150MC

### LED 6MC – Multi colour surgical LED lamp

Light output 140,000 Lux

- Colour rendering index Ra 98, colour temperature range: 3750, 4000, 4250, 4500 & 4750 Kelvin and focusable light field 18-30 cm diameter.
- Touch panel light intensity control (50 -100%) with on/off switch.
- Depth light and Endo light switching (for increased intensity to central LED segments or where outer segments are turned off).
- 69 LED's (life span 60,000h) included in 58 cm diameter lamp head with sterilisable handle.
- Supplied with a separate power supply unit (100-240V 50-60Hz) and housing.

Description	Product code
LED 6MC lamp and suspension arm only (for use with a Kenex ceiling radiation shield)	610/530/01
LED 6MC lamp, suspension arm and ceiling column	610/530/03



LED 6MC

### LED 300DF SC – Single colour surgical LED lamp

Light output 160,000 Lux

- Colour rendering index Ra 96, colour temperature 4500K.
- Step less dimming (28-100%) with on/off switch at lamp head.
- "Duo-Focus" system for merging and focusing the light field from 19-26 cm diameter.
- 36 LED's (life span 60,000h) included in 55 cm diameter lamp head with sterilisable handle.
- Supplied with a separate power supply unit (100-240V 50-60Hz) and housing.

Description	Product code
LED 300DF SC lamp and suspension arm only (for use with a Kenex ceiling radiation shield)	340/631/01
LED 300DF SC lamp, suspension arm and ceiling column	340/631/03



LED 300DF SC

Additional sterilisable handle available for all lights see page 25.

# Mobile lamps with LED technology

## Models LED 130F, 150F, 150FP & 6MC

### LED 130F, LED 150F & LED 150FP mobile lamp

Light output 70,000, 110,000 & 130,000 Lux

See page 19 for lamp details.

Description	Product code
LED 130F mobile lamp with power supply 70,000 Lux. Arm reach: 91 cm. Height range 69 - 193 cm	130/430/1300
LED 150F mobile lamp with power supply 110,000 Lux. Arm reach: 97 cm. Height range 61 - 184 cm	150/430/1300
LED 150FP mobile lamp with power supply 130,000 Lux. Arm reach: 97 cm. Height range 61 - 184 cm	150/530/1300



130/430/1300

### LED 6MC mobile surgical lamp

Light output 140,000 Lux

See opposite for lamp details.

Arm reach: 110 cm. Height range: 83 – 246 cm.

Description	Product code
Mobile lamp with power supply	610/530/1200



610/530/1200

### Additional sterilisable handle

Description	Product code
Spare sterilisable handle (available for all lights)	300/L/2115/0002



300/L/2115/0002





# Imaging accessories

We have been serving the worldwide medical community for over 50 years and use our experience to help our customers by providing only high performance accessories.

Those featured are designed in collaboration with medical professionals to provide innovative solutions to diagnostic imaging needs. All have been manufactured and tested to ensure they properly assist in obtaining quick and accurate results with the minimum of concern to the patient.

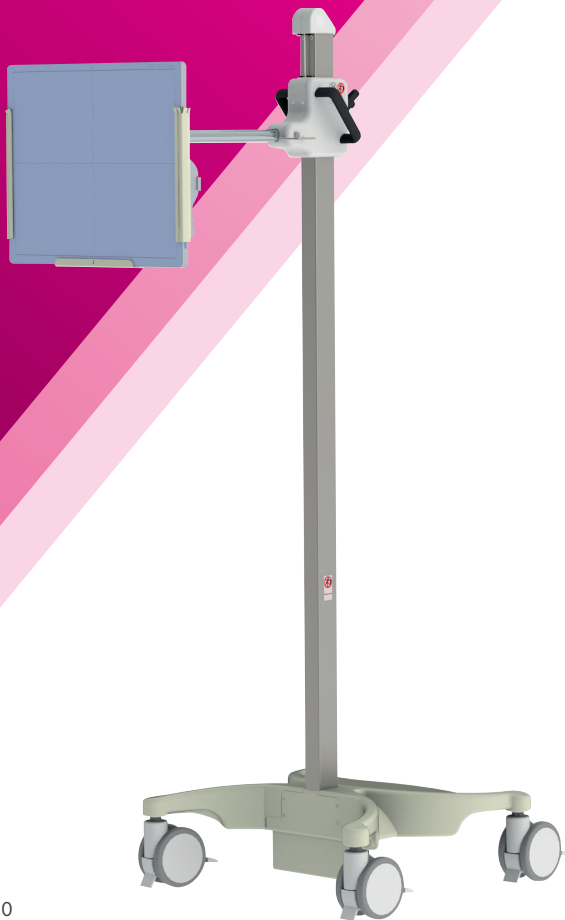

1330

## Mobile holders for DR panels and cassettes Models 1330/1305

### 1330 – Mobile DR detector and cassette holder

Stable and compact design holds portable DR Panels and CR or film cassettes from 24 x 30 cm to 35 x 43 cm. Also holds full leg/spine image receptors of any length.

- Unlimited orientation for universal positioning possibilities.
- Telescopic width adjustable from 24.5 cm to 53.5 cm with no protruding parts.
- Height adjustable from floor level to 129 cm.
- Counterbalance mechanism included for effortless raising or lowering.
- Overhangs table or trolley by up to 62 cm.
- Accepts cassettes and image receptors up to 30 mm thick.
- Large castors with roll and swivel locks ensure effortless movement.
- Castors are fitted with guards to prevent the pedestal running over cables.
- Heavy base and low centre of gravity gives added stability.

#### Description

Mobile detector holder: Counterbalance load 6.7 kg
Mobile detector holder: Counterbalance load 4.2 kg
Mobile detector holder: Counterbalance load 2.5 kg

#### Product code

1330/3
1330/4
1330/5

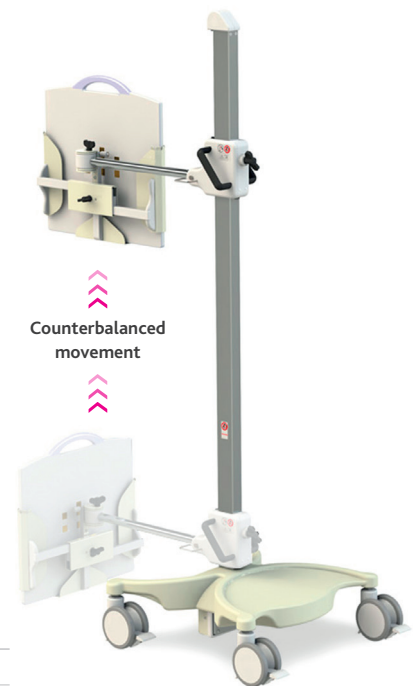

1330

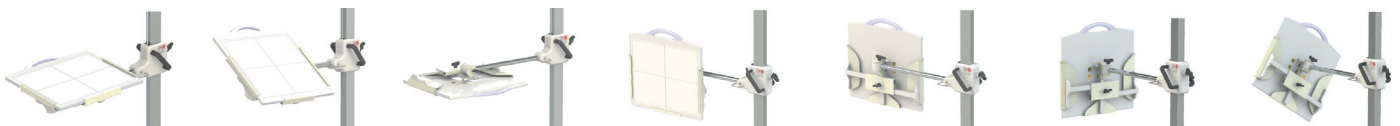



## 1305/8/1 – Mobile DR detector and cassette holder

Suitable for portable DR Panels and CR or film cassettes.

- Unlimited orientation for universal positioning possibilities.
- Telescopic width adjustable from 24.5 cm to 53.5 cm.
- Holds full leg/spine image receptors of any length.
- Not counterbalanced, but with easy height adjustment from floor level to 142 cm.
- Overhangs table or trolley by up to 49 cm.
- Accepts image receptor/cassette up to 30 mm thick of any length.
- Heavy base and low centre of gravity gives added stability.

Description	Product code
Mobile detector holder:	1305/8/1



1305/8/1

## 1305/3/1 – Mobile cassette holder

Cassettes or cassette-sized image receptors can be positioned at any angle.

- A versatile holder with universal applications.
- Telescopic width adjustable from 24.5 cm to 53.5 cm.
- Not counterbalanced, but with easy height adjustment from floor level to 120 cm.
- Ideal for routine lateral 'shoot-through' radiographs.
- Forward reach from column to cassette front: 36 cm.
- Accepts cassettes size image receptors up to 30 mm thick.

Description	Product code
Mobile cassette holder	1305/3/1



1305/3/1

## Positioning aids Model 1701

### 1701 – Sandbags

Supplied with or without a handle. Inner bag limp filed with silica sand. Outer bag nylon coated.

Size	Weight (approximate)	Product code
8 x 24 cm	0.7 kg	1701/02
10 x 30 cm	1.0 kg	1701/28
16 x 30 cm	1.7 kg	1701/06
16 x 40 cm	2.3 kg	1701/07
16 x 50 cm	2.8 kg	1701/08
16 x 60 cm	3.4 kg	1701/09
20 x 20 cm	1.4 kg	1701/18
20 x 30 cm	2.1 kg	1701/29
24 x 24 cm	2.0 kg	1701/10
30 x 30 cm	3.2 kg	1701/15
Reinforced handle fitted to any of the above sandbags		add/H to product code



1701

Available in Royal, Navy, Poppy or Bottle green. See page 29.



Suspension systems



X-ray shielding



Operating lamps



Imaging accessories



Protective clothing

## Patients chair Model 1501

### 1501/D – Patients imaging chair

This chair is ideal for a range of imaging procedures.

- Hydraulic operation alters the seat height between 55 and 70 cm.
- Height adjustment can be made with ease, regardless of the weight of a seated patient.
- A single lever can raise, lower or lock the rotation of the large and comfortable seat.
- The back and arm rests are held securely yet can be removed and replaced in seconds.
- Castors have rolling and swivel action brakes, so any locked pair will prevent movement.



1501/D with back  
& arms removed



1501/D

Description	Product code
Patients' imaging chair	1501/D

## Mobile Pedestal Models 1340/3 / 1340/3/LR

### 1340/3 – Mobile pedestal for tableside controls

This ergonomic mobile pedestal is designed to hold tableside equipment controls.

- 80 cm wide rails arranged in two tiers can accommodate several control modules.
- Both tiers are individually adjustable for height to suit controls and operator.
- The lower rail protrudes forward from the upper rail by 16 cm for a step wise setup.
- A heavy base with a 61 x 72 cm footprint gives stability and a low centre of gravity.
- Large twin wheel castors with roll and swivel locks ensure effortless movement.
- Castors are fitted with guards to prevent the pedestal running over cables.
- Overall height 124 cm



1340/3

Description	Product code
Mobile pedestal with 80 cm wide rails (7.7 x 25 mm section)	1340/3
Mobile pedestal with 80 cm wide rails (10 x 25 mm section)	1340/3/10

### 1340/3/LR – Mobile pedestal with attached radiation shield

Mobile pedestal as model 1340/3 but with an attached 80 cm wide 0.5 mm lead equivalent flexible protective curtain.



1340/3/LR

Description	Product code
Mobile pedestal 80 cm rails (7.7 x 25 mm section) and shield	1340/3/LR
Mobile pedestal 80 cm rails (10 x 25 mm section) and shield	1340/3/10/LR



# Quality and comfort



Current diagnostic and therapeutic procedures are often lengthy with x-ray protective clothing worn for extended periods.

It is therefore more important than ever that it correctly fits both the wearer and the application. Our extended range of LytaType x-ray protective clothing achieves these essential occupational health requirements by ensuring it is well tailored, flexible and comfortable to wear.

Kenex are certified to Regulation (EU) 2016/425 (PPE) for the design and manufacture of x-ray protective clothing. LytaType aprons and thyroid collars comply with the requirements of BS EN 61331-3 and BS EN 13402-3. They include lead (Pb) vinyl material tested for use with a 50 to 150 kV range of x-ray tube voltages, as specified in BS EN 61331-1.

907 Pocket 900/001 shown is an optional extra

## X-ray protective clothing Order guide

Please follow these instructions when ordering

To order please specify: 1. Model description, 2. Model number, 3. Lead equivalent, 4. Size, 5. Length taken from the middle shoulder, 6. Colour see below, 7. Any optional item.

All of our *LytaType* personal x-ray protective clothing can be tailor made to your personal requirements

A downloadable order guide and tailor made measurements sheet is available on request.

### LytaType colours and codes

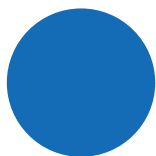

Royal  
02

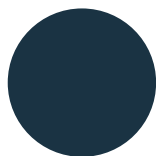

Navy  
04



Poppy  
11

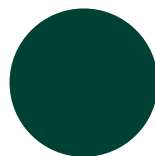

Bottle green  
41

Please note the colours shown are approximate. A colour swatch is available on request.

# X-ray protective clothing

## 907 – LytaType double sided apron

Very popular design with a shoulder clip and fastenings on both sides. Fitted with padded shoulders for extra comfort.

### **S** Small for chest sizes (A) 80 – 90 cm girth

Lead equivalent (Pb)* Front and back	Length (B)	Apron width shoulder / hip	Maximum girth of waist (C) or hip (D)	Product code
0.25 / 0.25 mm	85 cm	40 cm / 60 cm	100 cm	907/22/085/S
"	90 cm	"	"	907/22/090/S
"	100 cm	"	"	907/22/100/S
"	110 cm	"	"	907/22/110/S
0.35 / 0.35 mm	85 cm	40 cm / 60 cm	100 cm	907/33/085/S
"	90 cm	"	"	907/33/090/S
"	100 cm	"	"	907/33/100/S
"	110 cm	"	"	907/33/110/S
0.50 / 0.50 mm	85 cm	40 cm / 60 cm	100 cm	907/55/085/S
"	90 cm	"	"	907/55/090/S
"	100 cm	"	"	907/55/100/S
"	110 cm	"	"	907/55/110/S



907  
Pocket 900/001 shown  
is an optional extra.

### **M** Medium for chest sizes (A) 90 – 100 cm girth

0.25 / 0.25 mm	90 cm	48 cm / 60 cm	100 cm	907/22/090/M
"	100 cm	"	"	907/22/100/M
"	110 cm	"	"	907/22/110/M
0.35 / 0.35 mm	90 cm	48 cm / 60 cm	100 cm	907/33/090/M
"	100 cm	"	"	907/33/100/M
"	110 cm	"	"	907/33/110/M
0.50 / 0.50 mm	90 cm	48 cm / 60 cm	100 cm	907/55/090/M
"	100 cm	"	"	907/55/100/M
"	110 cm	"	"	907/55/110/M

### **L** Large for chest sizes (A) 100 - 120 cm girth

0.25 / 0.25 mm	90 cm	48 cm / 75 cm	120 cm	907/22/090/L
"	100 cm	"	"	907/22/100/L
"	110 cm	"	"	907/22/110/L
0.35 / 0.35 mm	90 cm	48 cm / 75 cm	120 cm	907/33/090/L
"	100 cm	"	"	907/33/100/L
"	110 cm	"	"	907/33/110/L
0.50 / 0.50 mm	90 cm	48 cm / 75 cm	120 cm	907/55/090/L
"	100 cm	"	"	907/55/100/L
"	110 cm	"	"	907/55/110/L

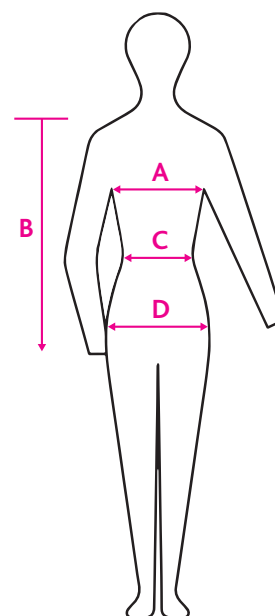

Also available: -

Lead equivalent Front and back	Product code
Front 0.35 mm, back 0.25 mm @ 0.35 / 0.35 mm prices less 4%	907/32/add length/add size
Front 0.50 mm, back 0.25 mm @ 0.50 / 0.50 mm prices less 15%	907/52/add length/add size
Front 0.50 mm, back 0.35 mm @ 0.50 / 0.50 mm prices less 12%	907/53/add length/add size
Please add length and S, M, or L (small, medium or large) to the applicable product code.	
Example: 0.35 front (3), 0.25 back (2), 90 cm long and medium size:	907/32/090/M

A downloadable order guide and tailor made measurements sheet is available on request. For colours please see page 29.

\*Pb: Lead vinyl in accordance with BS EN 61331-1 in the 50 to 150 kV range of x-ray tube voltages.

## 907 – Optional extras

Description	Product code
Pocket	900/001
Embroidery in a position to be specified	9/B20
Lumbar support belt elasticated type transfers weight to the hips	9/B15
Front fastening belt with VELCRO® closure	9/B16
Back fastening belt with VELCRO® closure	9/B17
Twin shoulder clips allow apron to 'fall-away' after use	9/B18
Right side closed fastenings on the shoulder and left side	9/B19



9/B15

A downloadable order guide and tailor made measurements sheet is available on request. For colours please see page 29.

## 905 – LytaType wrap-around coat

Front opening all-round coat with front VELCRO® fastening, fitted with padded shoulders for extra comfort. Wide front doubles the stated protection at the overlap.

**S** Small for chest sizes (A) 80 – 90 cm girth  
Protection is double where the front of the apron overlaps

Lead equivalent (Pb)* Front and back	Length (B)	Maximum girth of waist (C) or hip (D)	Product code
0.25 / 0.25 mm	85 cm	100 cm	905/22/085/S
"	90 cm	"	905/22/090/S
"	100 cm	"	905/22/100/S
"	110 cm	"	905/22/110/S
0.25 / 0.35 mm	85 cm	100 cm	905/23/085/S
"	90 cm	"	905/23/090/S
"	100 cm	"	905/23/100/S
"	110 cm	"	905/23/110/S
0.35 / 0.35 mm	85 cm	100 cm	905/33/085/S
"	90 cm	"	905/33/090/S
"	100 cm	"	905/33/100/S
"	110 cm	"	905/33/110/S

**M** Medium for chest sizes (A) 90 – 100 cm girth  
Protection is double where the front of the apron overlaps

0.25 / 0.25 mm	90 cm	100 cm	905/22/090/M
"	100 cm	"	905/22/100/M
"	110 cm	"	905/22/110/M
0.25 / 0.35 mm	90 cm	100 cm	905/23/090/M
"	100 cm	"	905/23/100/M
"	110 cm	"	905/23/110/M
0.35 / 0.35 mm	90 cm	100 cm	905/33/090/M
"	100 cm	"	905/33/100/M
"	110 cm	"	905/33/110/M



905 with a wide front overlap

Optional extras shown: -  
Pocket 900/001  
9/B15 support belt,  
951/05 thyroid collar see page 37.

\*Pb: Lead vinyl in accordance with BS EN 61331-1 in the 50 to 150 kV range of x-ray tube voltages.



Suspension systems



X-ray shielding



Operating lamps



Imaging accessories



Protective clothing

## > X-ray protective clothing continued

**L** Large for chest sizes (A) 100 – 120 cm girth  
Protection is double where the front of the apron overlaps

Lead equivalent (Pb)* Front and back	Length (B)	Maximum girth of waist (C) or hip (D)	Product code
0.25 / 0.25 mm	90 cm	120 cm	905/22/090/L
"	100 cm	"	905/22/100/L
"	110 cm	"	905/22/110/L
0.25 / 0.35 mm	90 cm	120 cm	905/23/090/L
"	100 cm	"	905/23/100/L
"	110 cm	"	905/23/110/L
0.35 / 0.35 mm	90 cm	120 cm	905/33/090/L
"	100 cm	"	905/33/100/L
"	110 cm	"	905/33/110/L

Also available: -

Lead equivalent front and back	Product code
Front 0.25 mm, back 0.50 mm @ 0.25 / 0.25 mm prices plus 20%	905/25/add length/add size
Front 0.35 mm, back 0.50 mm @ 0.25 / 0.25 mm prices plus 25%	905/35/add length/add size
Front 0.50 mm, back 0.50 mm @ 0.25 / 0.25 mm prices plus 30%	905/55/add length/add size
Please add length and S, M, or L (small, medium or large) to the applicable product code.	
Example: 0.25 front (2), 0.50 back (5), 90 cm long and medium size:	905/25/090/M

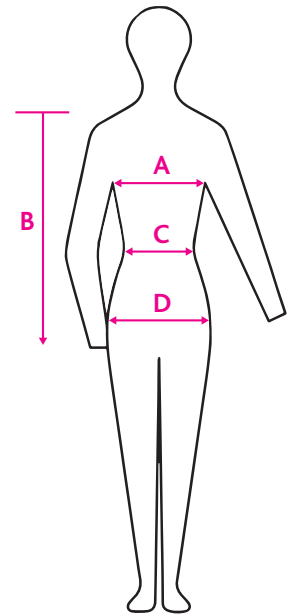

### 905 – Optional extras

Description	Product code
Pocket	900/001
Embroidery in a position to be specified	9/B20
Lumbar support belt elasticated type transfers weight to the hips	9/B15
Thyroid collar	951/05

A downloadable order guide and tailor made measurements sheet is available on request. For colours please see page 29.

### 903 – LytaType wrap-around coat

Front opening all-round coat with front VELCRO® fastening, fitted with padded shoulders for extra comfort. Narrow front doubles the stated protection at an overlap of approximately 15 cm. Prices: Same as for model 905.

### 903 – Optional extras

Description	Product code
Pocket	900/001
Embroidery in a position to be specified	9/B20
Thyroid collar	951/05

A downloadable order guide and tailor made measurements sheet is available on request. For colours please see page 29.

\*Pb: Lead vinyl in accordance with BS EN 61331-1 in the 50 to 150 kV range of x-ray tube voltages.



Model 903

## 910 – LytaType half back apron

Provides front protection plus a degree at the back and to either side.  
Fastened at the back with elasticated straps plus cross-over ties with a front buckle.

### **S** Small for chest sizes (A) 80 – 90 cm girth

Lead equivalent (Pb)* Front and back	Length (B)	Apron width shoulder / hip	Maximum girth of waist (C) or hip (D)	Product code
0.25 / 0.25 mm	85 cm	40 cm / 60 cm	100 cm	910/22/085/S
"	90 cm	"	"	910/22/090/S
"	100 cm	"	"	910/22/100/S
"	110 cm	"	"	910/22/110/S
0.35 / 0.25 mm	85 cm	40 cm / 60 cm	100 cm	910/32/085/S
"	90 cm	"	"	910/32/090/S
"	100 cm	"	"	910/32/100/S
"	110 cm	"	"	910/32/110/S
0.50 / 0.25 mm	85 cm	40 cm / 60 cm	100 cm	910/52/085/S
"	90 cm	"	"	910/52/090/S
"	100 cm	"	"	910/52/100/S
"	110 cm	"	"	910/52/110/S

### **M** Medium for chest sizes (A) 90 – 100 cm girth

0.25 / 0.25 mm	90 cm	48 cm / 60 cm	100 cm	910/22/090/M
"	100 cm	"	"	910/22/100/M
"	110 cm	"	"	910/22/110/M
0.35 / 0.25 mm	90 cm	48 cm / 60 cm	100 cm	910/32/090/M
"	100 cm	"	"	910/32/100/M
"	110 cm	"	"	910/32/110/M
0.50 / 0.25 mm	90 cm	48 cm / 60 cm	100 cm	910/52/090/M
"	100 cm	"	"	910/52/100/M
"	110 cm	"	"	910/52/110/M

### **L** Large for chest sizes (A) 100 - 120 cm girth

0.25 / 0.25 mm	90 cm	48 cm / 75 cm	120 cm	910/22/090/L
"	100 cm	"	"	910/22/100/L
"	110 cm	"	"	910/22/110/L
"	120 cm	"	"	910/22/120/L
0.35 / 0.25 mm	90 cm	48 cm / 75 cm	120 cm	910/32/090/L
"	100 cm	"	"	910/32/100/L
"	110 cm	"	"	910/32/110/L
"	120 cm	"	"	910/32/120/L
0.50 / 0.25 mm	90 cm	48 cm / 75 cm	120 cm	910/52/090/L
"	100 cm	"	"	910/52/100/L
"	110 cm	"	"	910/52/110/L
"	120 cm	"	"	910/52/120/L



910

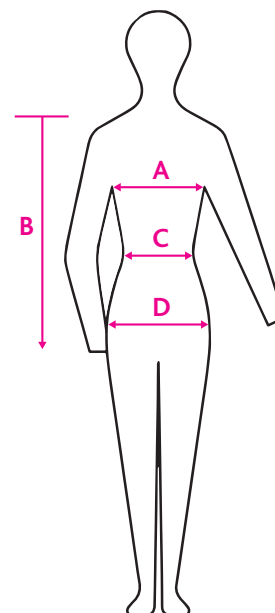

## 910 – Optional extras

Description	Product code
Pocket	900/001
Embroidery in a position to be specified	9/B20
Lumbar support belt elasticated type transfers weight to the hips	9/B15

A downloadable order guide and tailor made measurements sheet is available on request. For colours please see page 29.

\*Pb: Lead vinyl in accordance with BS EN 61331-1 in the 50 to 150 kV range of x-ray tube voltages.



## > X-ray protective clothing continued

### 909 – LytaType cross back apron

Excellent design transfers weight from the shoulders to the hips. Elasticated flaps fasten at the sides.

#### **S** Small for chest sizes (A) 80 – 90 cm girth

Lead equivalent (Pb)* Front and back	Length (B)	Apron width shoulder / hip	Maximum girth of waist (C) or hip (D)	Product code
0.25 / 0.25 mm	85 cm	40 cm / 60 cm	100 cm	909/22/085/S
"	90 cm	"	"	909/22/090/S
"	100 cm	"	"	909/22/100/S
"	110 cm	"	"	909/22/110/S
0.35 / 0.25 mm	85 cm	40 cm / 60 cm	100 cm	909/32/085/S
"	90 cm	"	"	909/32/090/S
"	100 cm	"	"	909/32/100/S
"	110 cm	"	"	909/32/110/S
0.50 / 0.25 mm	85 cm	40 cm / 60 cm	100 cm	909/52/085/S
"	90 cm	"	"	909/52/090/S
"	100 cm	"	"	909/52/100/S
"	110 cm	"	"	909/52/110/S



909

#### **M** Medium for chest sizes (A) 90 – 100 cm girth

0.25 / 0.25 mm	90 cm	48 cm / 60 cm	100 cm	909/22/090/M
"	100 cm	"	"	909/22/100/M
"	110 cm	"	"	909/22/110/M
0.35 / 0.25 mm	90 cm	48 cm / 60 cm	100 cm	909/32/090/M
"	100 cm	"	"	909/32/100/M
"	110 cm	"	"	909/32/110/M
0.50 / 0.25 mm	90 cm	48 cm / 60 cm	100 cm	909/52/090/M
"	100 cm	"	"	909/52/100/M
"	110 cm	"	"	909/52/110/M



#### **L** Large for chest sizes (A) 100 - 120 cm girth

0.25 / 0.25 mm	90 cm	48 cm / 75 cm	120 cm	909/22/090/L
"	100 cm	"	"	909/22/100/L
"	110 cm	"	"	909/22/110/L
0.35 / 0.25 mm	90 cm	48 cm / 75 cm	120 cm	909/32/090/L
"	100 cm	"	"	909/32/100/L
"	110 cm	"	"	909/32/110/L
0.50 / 0.25 mm	90 cm	48 cm / 75 cm	120 cm	909/52/090/L
"	100 cm	"	"	909/52/100/L
"	110 cm	"	"	909/52/110/L



### 911 – LytaType cross back apron

Excellent design transfers weight from the shoulders to the hips. Similar to model 909 but an elasticated front fastening belt.

Prices: Same as for model 909.

Measurements: Same as model 909.

### 909/911 – Optional extras

Description	Product code
Pocket	900/001
Embroidery in a position to be specified	9/B20

A downloadable order guide and tailor made measurements sheet is available on request. For colours please see page 29.

\*Pb: Lead vinyl in accordance with BS EN 61331-1 in the 50 to 150 kV range of x-ray tube voltages.



## 915 – LytaType jacket (vest)

VELCRO® fastened overlapping front provides all round protection.  
Front doubles the stated protection at an overlap of approximately 15 cm.

### **S** Small for chest sizes (A) 80 – 90 cm girth

Lead equivalent (Pb)* Front and back	Length (B)	Maximum girth	Product code
0.25 / 0.25 mm	52 cm	100 cm	915/22/S
0.25 / 0.35 mm	52 cm	"	915/23/S
0.35 / 0.35 mm	52 cm	"	915/33/S

### **M** Medium for chest sizes (A) 90 – 100 cm girth

Lead equivalent (Pb)*	Length (B)	Maximum girth	Product code
0.25 / 0.25 mm	58 cm	100 cm	915/22/M
0.25 / 0.35 mm	58 cm	"	915/23/M
0.35 / 0.35 mm	58 cm	"	915/33/M

### **L** Large for chest sizes (A) 100 – 120 cm girth

Lead equivalent (Pb)*	Length (B)	Maximum girth	Product code
0.25 / 0.25 mm	65 cm	120 cm	915/22/L
0.25 / 0.35 mm	65 cm	"	915/23/L
0.35 / 0.35 mm	65 cm	"	915/33/L

A downloadable order guide and tailor made measurements sheet is available on request. For colours please see page 29.



915 & 919  
Pockets 900/001 shown  
are optional extras



915

## 919 – LytaType kilt (skirt)

Front doubles the stated protection at the overlap.  
Front overlap of up to 15 cm provides extra central protection. Fitted with VELCRO® and belt fastening.

### **S** Small for waist sizes (C) 70 – 84 cm girth

Lead equivalent (Pb)* Front and back	Length	Product code
0.25 / 0.25 mm	55 cm	919/22/S
0.25 / 0.35 mm	55 cm	919/23/S
0.35 / 0.35 mm	55 cm	919/33/S

### **M** Medium for waist sizes (C) 78 – 99 cm girth

Lead equivalent (Pb)*	Length	Product code
0.25 / 0.25 mm	60 cm	919/22/M
0.25 / 0.35 mm	60 cm	919/23/M
0.35 / 0.35 mm	60 cm	919/33/M

### **L** Large for waist sizes (C) 90 – 115 cm girth

Lead equivalent (Pb)*	Length	Product code
0.25 / 0.25 mm	65 cm	919/22/L
0.25 / 0.35 mm	65 cm	919/23/L
0.35 / 0.35 mm	65 cm	919/33/L

A downloadable order guide and tailor made measurements sheet is available on request. For colours please see page 29.



919  
Pockets 900/001 shown  
are optional extras

\*Pb: Lead vinyl in accordance with BS EN 61331-1 in the 50 to 150 kV range of x-ray tube voltages.

## > X-ray protective clothing continued

### 917 – LytaType double-sided short top apron

An alternative to model 915 for use with Kilt model 919. Fitted with a shoulder clip and fastenings on both sides.

#### **S** Small for chest sizes (A) 80 – 90 cm girth

Lead equivalent (Pb)* Front and back	Length (B)	Apron width shoulder / hip	Maximum girth	Product code
0.25 / 0.25 mm	52 cm	40 cm / 60 cm	100 cm	917/22/S
0.35 / 0.25 mm	52 cm	"	"	917/32/S
0.35 / 0.35 mm	52 cm	"	"	917/33/S

#### **M** Medium for chest sizes (A) 90 – 100 cm girth

0.25 / 0.25 mm	58 cm	48 cm / 60 cm	100 cm	917/22/M
0.35 / 0.25 mm	58 cm	"	"	917/32/M
0.35 / 0.35 mm	58 cm	"	"	917/33/M

#### **L** Large for chest sizes (A) 100 – 120 cm girth

0.25 / 0.25 mm	70 cm	48 cm / 75 cm	120 cm	917/22/L
0.35 / 0.25 mm	70 cm	"	"	917/32/L
0.35 / 0.35 mm	70 cm	"	"	917/33/L



917

### 915/919/917 – Optional extras

Description	Product code
Pocket	900/001
Embroidery in a position to be specified	9/B20

A downloadable order guide and tailor made measurements sheet is available on request. For colours please see page 29.

### 921 – LytaType demi apron

Lower body aprons fitted with a soft vinyl covered spring waistband.

Lead equivalent (Pb)*	Size	Length	Width	Product code
0.5 mm	Toddler	25 cm	25 cm	921/05/01
	Child	30 cm	30 cm	921/05/02
	Adult	37 cm	40 cm	921/05/03
	Large adult	45 cm	50 cm	921/05/04



921

### 921-V – LytaType demi apron

Lower body aprons fitted with a VELCRO® fastening belt.

Lead equivalent (Pb)*	Size	Length	Width	Product code
0.5 mm	Toddler	25 cm	25 cm	921-V/05/01
	Child	30 cm	30 cm	921-V/05/02
	Adult	37 cm	40 cm	921-V/05/03
	Large adult	45 cm	50 cm	921-V/05/04

For colours please see page 29.

\*Pb: Lead vinyl in accordance with BS EN 61331-1 in the 50 to 150 kV range of x-ray tube voltages.

## 951/05 – Thyroid collar

Collar and bib type for the best fit and comfort.

- Soft flexible and adjustable for any neck size.
- Provides optimum protection to the thyroid area.
- Lead equivalent 0.5 mm VELCRO® closure.

Description	Product code
Thyroid collar	951/05

For colours please see page 29.



951/05

## 953/05 – Thyroid collar

One-piece design without edge binding.

- Very soft and flexible.
- Lead equivalent 0.5 mm.
- VELCRO® closure for any neck size.

Description	Product code
Thyroid collar	953/05

For colours please see page 29.



953/05

## 278 – Ovary shields

Provides maximum protection without interfering with diagnostically important areas of image. 1.0 mm Pb equivalent shields adjust in a fan-wise fashion to fit the pelvis.

Description	Product code
Ovary shields set of 3 sizes	278/SET



278

## 299 – T shape gonad shields

2.0 mm lead centre section encased in tough plastic.

Description	Product code
T shape shields set of 3 sizes	299/SET



299

## > X-ray protective clothing continued

### 265 – Radiation protective glasses

Optically correct 0.75 mm Pb lead glass lenses with 0.50 mm lead foil side protection.

#### Description

Radiation protective glasses

#### Product code

265/SW/S



265/SW/S

## > Apron storage racks Models 100/102/103

### 100 – Multiform apron wall console

A swivel hanger rack that prolongs the life of protective clothing.

- Occupies minimal wall space.
- Clothing is clearly arranged.
- Shaped hangers extend the service life of protective clothing.
- Hangers fan out from the wall for immediate access, or fold flat when fully loaded.
- Left and right racks together provide storage for up to 10 aprons.

#### Description

1 swivel arm (180° movement)

2 arms swivel to the right

2 arms swivel to the left

3 arms swivel to the right

3 arms swivel to the left

4 arms swivel to the right

4 arms swivel to the left

5 arms swivel to the right

5 arms swivel to the left

#### Product code

100/1

100/2R

100/2L

100/3R

100/3L

100/4R

100/4L

100/5R

100/5L



100/1

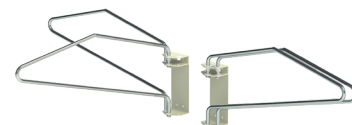

100/2L

100/2R

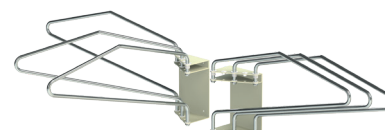

100/3L

100/3R

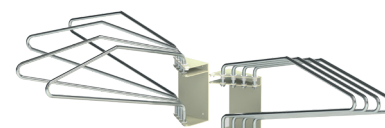

100/4L

100/4R

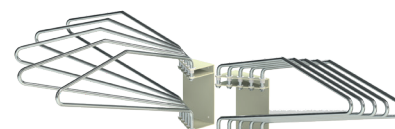

100/5L

100/5R



100/5L & 100/5R

## 102/C – Mobile swivel arm apron rack

Ideal for departments where wall racks cannot be installed.

- Hangers fan so aprons can be selected, removed and replaced with ease.
- Racks are compact and can be parked at any convenient location and moved as required.
- The hanger profile provides correct storage for protective clothing.

Dimensions: 61 cm wide x 64 cm deep x 155 cm high.

Description	Product code
Rack for up to 6 garments	102/C/06
Rack for up to 11 garments	102/C/11



102/C/11

## 100 – Kilt / skirt hooks

A pair of hooks can be simply added to a swivel hanger at any time.

- Kilts with internal fitted loops can be suspended from the hooks.
- Use with models 100 and 102.

Description	Product code
Hooks, per pair	100/428



100/428

## 103 – Mobile apron rail

Accommodates aprons on optional coat hangers.

Dimensions: 57 cm wide x 61 cm deep x 140 cm high.

Description	Product code
Mobile apron rail	103
Coat hanger	106



103



106



Suspension systems



X-ray shielding



Operating lamps



Imaging accessories



Protective clothing

# > Terms and conditions

## Acceptance of orders

Orders are accepted subject to the following business terms and conditions: -

## Price list

All prices listed are in GB Pounds Sterling, are provisional only and are subject to alteration without notice. Unless otherwise agreed, prices are for goods EX WORKS Harlow (EXW) in accordance with the International Chamber of Commerce (ICC) trade terms: Incoterms 2020. Prices are exclusive of VAT. VAT if applicable will be charged at the current rate.

## Terms of payment

Credit accounts are strictly net payable within 30 days of invoice date.

## Carriage

As a general rule carriage will be charged at cost, with shipments made at the purchaser's risk. If transport insurance is requested and undertaken it will be charged to the purchaser as an additional cost. Unless we are given specific instructions we select the manner and route of shipment.

## Damage or loss in transit

Any claim made concerning damage or shortages must be made in writing to us within 3 days of delivery of the goods. Any claim for non-delivery must be made in writing to us within 14 days from the date of our invoice. Original packaging must be retained.

## Retention of title

Notwithstanding that delivery of the goods has been made, they remain the property of Kenex until payment is made in full.

## Time of delivery

Every effort will be made to adhere to quoted delivery times. However, no liability can be accepted for any losses incurred by the purchaser for a failure to deliver within the stated period. Delays shall not entitle the purchaser to cancel the order nor to claim damages. We reserve the right to make partial deliveries.

## Guarantee

We will make good at our discretion by repair or by the supply of a replacement, defects that appear in the goods of our manufacture and arise solely from faulty workmanship or materials, provided that the goods are returned to us carriage paid within one year from the date of delivery. Goods subject to fair wear & tear, misuse or inadequate maintenance are excluded. Any claim under this guarantee shall be limited to the cost of the goods.

## Limitation of liability

Other than the statements made in Kenex literature, no warranty is expressed or implied as to the suitability of any product for any purpose. Purchasers must satisfy themselves on this point. Persons authorised to select or use Kenex X-ray protective garments, shields or other products must be aware of the dangers of exposure to radiation.

## Specifications & descriptions

Technical data, dimensions, weights and illustrations are typical and not binding. Kenex reserve the right to improve or amend any product without notice.

## Patents, trademarks, copyright and designs

Kenex is a registered trademark of Kenex (Electro-Medical) Limited. Kenex products are covered by patents and/or registered designs. Copyright: All rights reserved. No part of this publication may be reproduced without prior written permission.



## Quality management systems and certification

Kenex is compliant and certified according to the following regulations and standards regarding design and manufacture of medical devices: -

- 2017/745 Medical device regulation (MDR)
- 2016/425 Personal protective equipment (PPE)
- EN ISO 9001 (Quality management systems requirements)
- EN ISO 13485 (Quality management systems for medical devices)
- EN 61331-1 (Determination of x-ray attenuation properties)
- EN 61331-2 (Translucent protective plates)
- EN 61331-3 (X-ray protective clothing)
- EN 60601-1 (Medical electrical equipment – basic safety and essential performance)

Where appropriate Kenex products are CE certified and most are UL classified.



**Kenex (Electro-Medical) limited was established in 1970**







Kenex (Electro-Medical) Limited  
Unit 17, RO24 Greenway  
Harlow Business Park  
Harlow, Essex  
CM19 5QB  
England

T: +44 (0)1279 417241  
F: +44 (0)1279 443749  
E: [kenex@kenex.co.uk](mailto:kenex@kenex.co.uk)  
[www.kenex.co.uk](http://www.kenex.co.uk)

