

Bocht 30° DWD

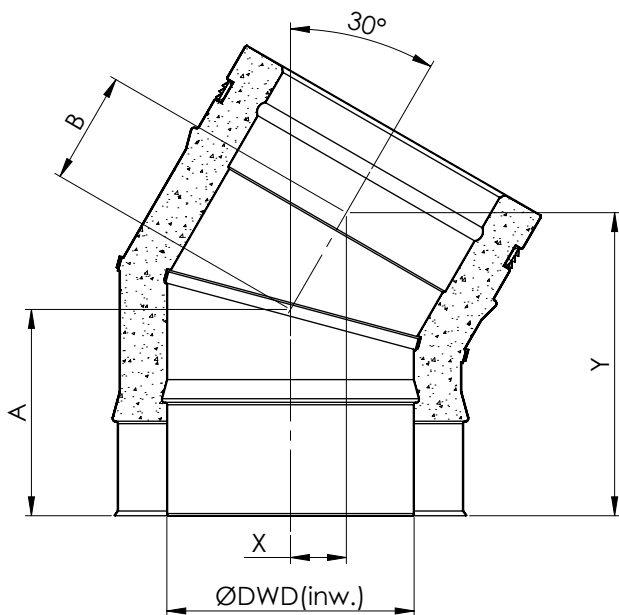

DWD	A	B	X	Y
80	105	55	28	153
100	105	55	28	153
130	109	59	30	160
150	112	62	31	165
180	116	66	33	173
200	118	68	34	178
250	125	75	38	190
300	132	82	41	203
350	139	89	44	215
400	145	95	48	228